

**Brake equipment
for commercial
vehicles**



2010 | 2011



BOSCH

de

en

fr

it

es

**Bosch –
der Spezialist für
Bremsysteme**

**Bosch –
The brake-system
specialist**

**Bosch –
le spécialiste des
systèmes de freinage**

**Bosch –
lo specialista dei
sistemi frenanti**

**Bosch –
el especialista en
sistemas de freno**



**Bosch-Bremsenkompetenz
für Handel und Werkstatt.
Komplettprogramm mit
über 10.000 Erzeugnissen.**

- ▶ Brems Scheiben
- ▶ Scheibenbremsbeläge
und Zubehör
- ▶ Warnkontakte
- ▶ Bremstrommeln
- ▶ Trommelbremsbacken
und Zubehör
- ▶ Radbremszylinder
- ▶ Kit Pro und Kit Super Pro
- ▶ Bremsättel und Repara-
tursätze Bremsättel
- ▶ Bremsflüssigkeit
- ▶ Brems- und Kupplungs-
hydraulik, elektronische
Bremsregelsysteme

**Bosch braking-system
expertise for the aftermar-
ket and workshop sectors.
Comprehensive range of
over 10,000 products.**

- ▶ Brake discs
- ▶ Disc-brake linings and
accessories
- ▶ Wear sensors
- ▶ Brake drums
- ▶ Drum-brake shoes and
accessories
- ▶ Wheel-brake cylinders
- ▶ Kit Pro and Kit Super Pro
- ▶ Brake calipers and
brake-caliper repair sets
- ▶ Brake fluid
- ▶ Brake and clutch hydraul-
ic systems, electronic
brake-control systems

**La compétence de Bosch
en matière de freinage pour
le commerce et le garage.
Une gamme complète avec
plus de 10.000 références.**

- ▶ Disques de frein
- ▶ Garnitures de frein
à disques et accessoires
- ▶ Témoins d'usure
- ▶ Tambours de frein
- ▶ Mâchoires de frein
à tambours et accessoires
- ▶ Cylindres de frein de
roues
- ▶ Kit Pro et Kit Super Pro
- ▶ Etriers de frein et kits
de réparation pour étriers
de frein
- ▶ Liquide de frein
- ▶ Hydraulique de freinage
et d'embrayage, systèmes
électroniques de régula-
tion du freinage

**La competenza Bosch
nel settore frenante per
l'aftermarket e l'officina.
Un programma completo
con oltre 10.000 prodotti.**

- ▶ Dischi freno
- ▶ Pastiglie per freni a disco
ed accessori
- ▶ Rilevatori d'usura
- ▶ Tamburi freno
- ▶ Ganasce per freni
a tamburo ed accessori
- ▶ Cilindretti freno
- ▶ Kit Pro e Kit Super Pro
- ▶ Pinze freno e kit di ripara-
zione per pinze freno
- ▶ Liquido freni
- ▶ Impianti idraulici per
freni e frizione, sistemi
elettronici di regolazione
della frenata

**Bosch es sinónimo de efici-
encia en materia de frenos,
para el comercio
y el taller.**

**Programa completo con
más de 10.000 productos.**

- ▶ Discos de freno
- ▶ Pastillas de freno
y accesorios
- ▶ Avisadores de desgaste
- ▶ Tambores de freno
- ▶ Zapatas de freno
y accesorios
- ▶ Cilindros de rueda
- ▶ Kit Pro y Kit Super Pro
- ▶ Pinzas de freno y juegos
de reparación para pinzas
de freno
- ▶ Líquido de frenos
- ▶ Hidráulica de frenos
y embrague, sistemas
electrónicos de regulación
de freno

de

Inhalt

en

Content

fr

Contenu

it

Contenuto

es

Contenido

Angebot	Offer	Offre	Offerta	Oferta	
Funktionsprinzipien von Nachstelleinheiten	Function principles of adjusting units	Principles de fonctionnement d'unités de rattrapage de jeu	Principi di funzionamento delle unità di regolazione	Principios funcionales de unidades reajustables	A 2
Scheibenbremsbeläge – sortiert nach Bestellnummern	Disc-brake pads – in part number order	Plaquettes de freins à disque – classées suivant la référence	Pastiglie per freni a disco – ordinate secondo in n. d'ordinazione	Pastillas de frenos de disco – clasificadas según referencia de pedido	A 4
Scheibenbremsbeläge – sortiert nach WVA-Nummer	Disc-brake pads – in WVA-number order	Plaquettes de freins à disque – classées suivant le no. WVA	Pastiglie per freni a disco – ordinate secondo n. WVA	Pastillas de freno de disco – clasificadas según número WVA	A 6
Bremsscheiben	Brake discs	Disques de freins	Dischi per freni	Discos de freno	A 8
Bremstrommeln	Brake drums	Tambour de freins	Tamburi per freni	Tambores de freno	A 13
Trommelbremsbacken	Drum-brake shoes	Mâchoires de freins à tambour	Ganasce per freni a tamburo	Zapatras de frenos de tambor	A 14

Verwendung	Applications	Affectations	Impiego	Aplicaciones	
Scheibenbremsbeläge und Zubehör, Warnkontakte, Trommelbremsbacken und Zubehör, Bremsscheiben, Bremstrommeln	Disc-brake pads and accessories, Wear indicators, Drum-brake shoes and accessories, Brake discs, Brake drums	Plaquettes de freins à disque et accessoires, Témoins d'usure, Mâchoires de freins à tambour et accessoires, Disques de freins, Tambours de freins	Pastiglie per freni a disco e serie parti, Rilevatori d'usura, Ganasce per freni a tamburo e serie parti, Dischi per freni, Tamburi per freni	Pastillas de freno y accesorios, Avisadores de desgaste, Zapatras de freno y accesorios, Discos de freno, Tambores de freno	B 2

Gegenüberstellung	Cross-reference	Table de correspondance	Comparazione	Equivalencias	
Bestellnummern	Part numbers	Références	Numeri d'ordinazione	Referencias	C 2

Bildzeichen- und Sonderfallrklärungen siehe Katalogende.

See last pages for Pictogram and Special cases explanations.

Signification des pictogrammes et des codes spécifiques voir aux dernières pages.

Per il significato dei pittogrammi e dei casi particolari vedere le ultime pagine.

Abreviaturas, casos especiales y aclaraciones sobre los pictogramas mirar al final del catálogo.

de

Funktionsprinzipien
von Nachstellein-
heiten

en

Function principles
of adjusting units

fr

Principes de fonc-
tionnement d'unités
de rattrapage de jeu

it

Principi di funziona-
mento delle unità di
regolazione

es

Principios funcio-
nales de unidades
reajustables



RAD



Bosch (R25)



Lucas (Escort)



Volkswagen (Golf)



Bosch (Fiesta)



A P Lockheed (Punto)

RAI



Lucas (305)



Bosch (R21)



Lucas (Corsa)

Es gibt 2 Arten von automatischen Nachstelleinheiten, um das Luftspiel zwischen Bremsbacken und Bremstrommeln bei Belagverschleiß gleich zu halten:

- ▶ RAD – automatische Nachstellung mit Zahnelement
- ▶ RAI – automatische Nachstellung mit Gewindeelement

There are 2 types of automatic adjusters that take up the play between the brake shoes and brake drums as the lining wears:

- ▶ RAD – automatic adjusting with toothed element
- ▶ RAI – automatic adjusting with threaded element

Il existe 2 types de rattrapage automatique pour le maintien du jeu entre les mâchoires de frein et les tambours de frein en au fur et à mesure de l'usure des garnitures de frein:

- ▶ RAD – rattrapage automatique à dents
- ▶ RAI – rattrapage automatique incrémental

Esistono 2 tipi di unità di regolazione automatiche, che permettono di mantenere costante il gioco tra ceppi e tamburi del freno in caso di usura delle ganasce:

- ▶ RAD – regolazione automatica con elemento dentato
- ▶ RAI – regolazione automatica incrementale

Existen 2 tipos de unidades reajustables automáticas para mantener constancia entre las zapatas de freno y los tambores de freno en caso de desgaste del revestimiento:

- ▶ RAD – reajuste automático sobre un elemento dentado
- ▶ RAD – actúa sobre un piñón reajutable en un elemento roscado

de

Scheibenbremsbelägesortiert nach
Bestellnummern

en

Disc-brake pads

in part number order

fr

Plaquettes de freins à disqueclassées suivant
la référence

it

Pastiglie per freni a discoordinate secondo
in n. d'ordinazione

es

Pastillas de frenos de discoclasificadas según
referencia de pedido

WVA



WVA



0 986 424 026		20 288	CITROËN
0 986 424 098	18	20 775	AUTOBIANCHI
			FIAT
			LANCIA
			SEAT
0 986 424 133	15,5	20 182	TOYOTA
0 986 424 137	16	21 015	TOYOTA
0 986 424 157	15,5	21 115	SUZUKI
0 986 424 183	15,5	21 837	TOYOTA
0 986 424 218	20,6	21 576	MERCEDES-BENZ
			VW (VOLKSWAGEN)
0 986 424 219	18,5	21 592	MERCEDES-BENZ
0 986 424 225	15,5	21 689	TOYOTA
0 986 424 268	15	21 680	TOYOTA
			VW (VOLKSWAGEN)
0 986 424 313	15,2	21 947	TOYOTA
0 986 424 319	15,5	21 468	TOYOTA
0 986 424 372	15	21 256	RENAULT
0 986 424 373	17,5	21 662	SKODA
			VW (VOLKSWAGEN)
0 986 424 382	16	21 158	TOYOTA
			VW (VOLKSWAGEN)
0 986 424 463	17	21 621	MERCEDES-BENZ
0 986 424 468	16,1	21 945	SEAT
			VW (VOLKSWAGEN)
0 986 424 480	17,8	23 302	OPEL
			RENAULT
			VAUXHALL
0 986 424 487	17,3	21 980	CITROËN
			NISSAN
			RENAULT
0 986 424 516	19	23 021	MERCEDES-BENZ
			STEYR (STEYR-DAIMLER-PUCH AG)
			VW (VOLKSWAGEN)
0 986 424 527	17	23 225	OPEL
			VAUXHALL
0 986 424 528	14	23 284	OPEL
			VAUXHALL
0 986 424 537	19,6	23 163	VW (VOLKSWAGEN)
0 986 424 636	18,4	23 099	OPEL
			RENAULT
			VAUXHALL
0 986 424 640	17,6	23 524	TOYOTA
0 986 424 646	15	23 417	OPEL
			VAUXHALL
0 986 424 671	16,8	40 118	RENAULT
0 986 424 672	19	21 479	VW (VOLKSWAGEN)
0 986 424 695	15	23 507	SUZUKI
0 986 424 707	20,4	23 832	OPEL
			VAUXHALL

0 986 424 750	20,3	29 123	IVECO
0 986 424 777	20,1	23 269	FORD
			SEAT
			VW (VOLKSWAGEN)
0 986 424 785	18,1	23 930	TOYOTA
0 986 424 797	20,3	23 587	AUDI
			SEAT
			SKODA
			VW (VOLKSWAGEN)
0 986 424 832	20	29 153	MERCEDES-BENZ
			VW (VOLKSWAGEN)
0 986 424 833	17	29 121	IVECO
0 986 460 002	17,8	23 020	MERCEDES-BENZ
0 986 460 111	18,6	20 011	VW (VOLKSWAGEN)
0 986 460 736	17,3	20 073	FSO
0 986 460 932	15,6	20 380	RENAULT
0 986 460 935	15	21 142	SUZUKI
0 986 460 938	16,5	21 353	CHEVROLET
			DAEWOO
			OPEL
			VAUXHALL
0 986 460 941	19	20 124	VW (VOLKSWAGEN)
0 986 460 943	16	20 168	SEAT
			VW (VOLKSWAGEN)
0 986 460 944	19,5	20 168	AUDI
			SEAT
			VW (VOLKSWAGEN)
0 986 460 946	18,5	20 926	OPEL
			RENAULT
0 986 460 954	18,1	20 652	VW (VOLKSWAGEN)
0 986 460 960	16,5	21 544	ISUZU
			OPEL
			VAUXHALL
0 986 460 998	19,5	21 205	CITROËN
			FIAT
			PEUGEOT
			TALBOT
0 986 461 149	11	21 597	RENAULT
0 986 461 396	14	20 347	DACIA
			RENAULT
0 986 461 753	19	21 479	VW (VOLKSWAGEN)
0 986 461 763	17,8	20 986	PEUGEOT
			RENAULT
0 986 461 768	14	21 842	MITSUBISHI
0 986 461 769	17	20 961	AUDI
			CITROËN
			FORD
			PEUGEOT
			SEAT
			SKODA
			VW (VOLKSWAGEN)

de

Scheibenbremsbelägesortiert nach
WVA-Nummer

en

Disc-brake pads

in WVA-number order

fr

Plaquettes de freins à disqueclassées suivant
le no. WVA

it

Pastiglie per freni a discoordinate secondo
n. WVA

es

Pastillas de frenos de discoclasificadas según
número WVA

WVA	mm		
20 011	18,6	0 986 460 111	VW (VOLKSWAGEN)
20 073	17,3	0 986 460 736	FSO
20 124	19	0 986 460 941	VW (VOLKSWAGEN)
20 168	16	0 986 460 943	SEAT VW (VOLKSWAGEN)
20 168	19,5	0 986 460 944	AUDI SEAT VW (VOLKSWAGEN)
20 182	15,5	0 986 424 133	TOYOTA
20 280	17,5	0 986 462 803	VW (VOLKSWAGEN)
20 288		0 986 424 026	CITROËN
20 347	14	0 986 461 396	DACIA RENAULT
20 380	15,6	0 986 460 932	RENAULT
20 480	15,5	0 986 464 801	RENAULT
20 488	17	0 986 464 881	RENAULT
20 573		0 986 465 733	TALBOT
20 652	18,1	0 986 460 954	VW (VOLKSWAGEN)
20 731	15,5	0 986 467 311	SUZUKI
20 741	19	0 986 467 411	CITROËN FIAT PEUGEOT TALBOT
20 775	18	0 986 424 098	AUTOBIANCHI FIAT LANCIA SEAT
20 852	15,5	0 986 468 520	TOYOTA
20 861	17,5	0 986 468 613	SKODA
20 887	19,6	0 986 468 870	VW (VOLKSWAGEN)
20 926	18,5	0 986 460 946	OPEL RENAULT
20 958	16	0 986 469 580	NISSAN SUBARU
20 961	17	0 986 461 769	AUDI CITROËN FORD PEUGEOT SEAT SKODA VW (VOLKSWAGEN)
20 979	19,6	0 986 469 790	VW (VOLKSWAGEN)
20 986	17,8	0 986 469 860	CITROËN PEUGEOT
20 986	17,8	0 986 461 763	PEUGEOT RENAULT
21 015	16	0 986 424 137	TOYOTA
21 096	14,5	0 986 466 346	RENAULT
21 115	15,5	0 986 424 157	SUZUKI
21 142	15	0 986 460 935	SUZUKI

WVA	mm		
21 158	16	0 986 424 382	TOYOTA VW (VOLKSWAGEN)
21 205	19,5	0 986 460 998	CITROËN FIAT PEUGEOT TALBOT
21 256	15	0 986 424 372	RENAULT
21 353	16,5	0 986 460 938	CHEVROLET DAEWOO OPEL VAUXHALL
21 463	18	0 986 467 720	DACIA PEUGEOT RENAULT
21 468	15,5	0 986 424 319	TOYOTA
21 479	19	0 986 461 753	VW (VOLKSWAGEN)
21 479	19	0 986 424 672	VW (VOLKSWAGEN)
21 544	16,5	0 986 460 960	ISUZU OPEL VAUXHALL
21 576	20,6	0 986 424 218	MERCEDES-BENZ VW (VOLKSWAGEN)
21 592	18,5	0 986 424 219	MERCEDES-BENZ
21 597	11	0 986 461 149	RENAULT
21 621	17	0 986 424 463	MERCEDES-BENZ
21 662	17,5	0 986 424 373	SKODA VW (VOLKSWAGEN)
21 680	15	0 986 424 268	TOYOTA VW (VOLKSWAGEN)
21 689	15,5	0 986 424 225	TOYOTA
21 837	15,5	0 986 424 183	TOYOTA
21 842	14	0 986 461 768	MITSUBISHI
21 883	19,6	0 986 494 008	VW (VOLKSWAGEN)
21 904	16,3	0 986 494 000	MERCEDES-BENZ
21 945	16,3	0 986 494 010	SEAT VW (VOLKSWAGEN)
21 945	16,1	0 986 424 468	SEAT VW (VOLKSWAGEN)
21 947	15,2	0 986 424 313	TOYOTA
21 980	17,3	0 986 424 487	CITROËN NISSAN RENAULT
23 020	17,8	0 986 460 002	MERCEDES-BENZ
23 021	19	0 986 424 516	MERCEDES-BENZ STEYR (STEYR-DAIMLER-PUCH AG) VW (VOLKSWAGEN)
23 099	18,4	0 986 424 636	OPEL RENAULT VAUXHALL
23 163	19,6	0 986 424 537	VW (VOLKSWAGEN)



	Ø = A	Ø = C	B	B	U **	
	mm	mm	maximum mm	minimum mm		
0 986 478 011	239	65	11,9	10	4	AUDI, SEAT, VW (VOLKSWAGEN)
0 986 478 046	247,5	66	10	8	4	CITROËN, PEUGEOT
0 986 478 052	244,5	62	8,9	8	3	CITROËN
0 986 478 063	227	62	10,8	9	4	AUTOBIANCHI, FIAT, LANCIA, SEAT, TOFAS
0 986 478 065	277	67	16	13	5	VW (VOLKSWAGEN)
0 986 478 067	257	72	12	10,8	5	CITROËN, FIAT, PEUGEOT
0 986 478 080	236	60	10	7	6	OPEL, VAUXHALL
0 986 478 081	236	60	12,6	9,7	6	BEDFORD, CHEVROLET, OPEL, VAUXHALL
0 986 478 091	273	76	12,7	10,7	4	PEUGEOT
0 986 478 103	227,5	83	10	9	6	DACIA, RENAULT
0 986 478 105	238	61	12	10,6	4	RENAULT
0 986 478 106 *	255	74	20	19	4	TOYOTA
0 986 478 113 *	252,5	76	24	22	6	OPEL, RENAULT
0 986 478 115 *	240	61	21	19	4	HONDA
0 986 478 121	238	86	11	9,5	4	SAAB (SAAB AUTOMOBILE AB)
0 986 478 124 *	259	61	20,6	17,7	4	RENAULT
0 986 478 136	278	45,23	13	11	5	VW (VOLKSWAGEN)
0 986 478 138	281	91	20	18	5	VW (VOLKSWAGEN)
0 986 478 160 *	254	78,5	24,5	22,2	5	FORD
0 986 478 166 *	270	78,5	24,1	22,2	5	FORD
0 986 478 190	270	78,5	14,3	12,9	5	FORD
0 986 478 192 *	236	60	20	18,2	4	BEDFORD, CHEVROLET, DAEWOO, OPEL, VAUXHALL
0 986 478 200	255	73	16	13,5	5	CITROËN, FIAT, PEUGEOT, TALBOT
0 986 478 201	280	88	16	14,4	5	MERCEDES-BENZ
0 986 478 224	258	45,2	16	13	5	VW (VOLKSWAGEN)
0 986 478 234	290	73	16	14,8	5	CITROËN, FIAT, PEUGEOT, TALBOT
0 986 478 249 *	238	75	18	16	4	MAZDA
0 986 478 251 *	255	87	20	18,4	6	MINI
0 986 478 253	243	86	12,7	11,4	4	MINI
0 986 478 254 *	242	86	18	16,4	4	MINI
0 986 478 260	250	76	18	11	4	NISSAN
0 986 478 268 *	265,8	66	20,5	18,5	4	CITROËN, PEUGEOT
0 986 478 271 *	258	87	22	20,4	6	MINI
0 986 478 273	238	61	8	7	4	RENAULT
0 986 478 276 *	238	61	20	17,7	4	RENAULT
0 986 478 277 *	236	86	18	16,4	4	MINI
0 986 478 278 *	243,5	61	20,5	17,7	4	RENAULT
0 986 478 282	234	86	13	11,4	4	MINI
0 986 478 296 *	313	68	26	22	5	FORD, SEAT, VW (VOLKSWAGEN)
0 986 478 299 *	276	82	24,5	22,1	5	FORD
0 986 478 303 *	294	82	24,5	22,1	5	FORD
0 986 478 304	302	100	12,5	11,5	6	TOYOTA
0 986 478 308 *	256	65	20	18	4	SEAT, VW (VOLKSWAGEN)
0 986 478 329	255,8	65	13	11	4	SEAT, VW (VOLKSWAGEN)
0 986 478 345	254	78,5	14,3	12,7	5	FORD
0 986 478 353	240,5	59	12	10,8	4	AUTOBIANCHI, FIAT, INNOCENTI (NUOVA INNOCENTI), LANCIA
0 986 478 357	238,5	102	16	14,5	5	MERCEDES-BENZ
0 986 478 358 *	255,5	84	20	18,4	5	MINI
0 986 478 361 *	250	68	22	20	4	NISSAN
0 986 478 376	215	86	10	9	4	CHEVROLET, DAEWOO, SUZUKI
0 986 478 377	290	107	10	9	5	SUZUKI



	$\varnothing = A$	$\varnothing = C$	B	B	U**	
	mm	mm	maximum mm	minimum mm		
0 986 478 385 *	238	54	18	17	4	TOYOTA
0 986 478 392 *	212	65	18	15,5	4	SUBARU
0 986 478 397	257	84	25	24	5	TOYOTA, VW (VOLKSWAGEN)
0 986 478 398 *	230,5	74	20	19	4	TOYOTA
0 986 478 406	304	118	30	26	6	MERCEDES-BENZ
0 986 478 407 *	324	118	30	26	6	MERCEDES-BENZ
0 986 478 433	272	85	16	14	5	MERCEDES-BENZ, STEYR (STEYR-DAIMLER-PUCH AG), VW (VOLKSWAGEN)
0 986 478 434 *	280	73	24	21,9	5	CITROËN, FIAT, PEUGEOT
0 986 478 442	238	52	8	7	4	RENAULT
0 986 478 452 *	255	84	25	23	5	TOYOTA
0 986 478 453	289	100	20	18	6	TOYOTA, VW (VOLKSWAGEN)
0 986 478 456 *	304	118	30	26	6	MERCEDES-BENZ
0 986 478 457 *	324	118	30	26	6	MERCEDES-BENZ
0 986 478 458 *	250	73	22	20	4	NISSAN
0 986 478 484 *	260	84,3	26	24	5	NISSAN
0 986 478 485 *	256,5	68	26	24	5	NISSAN
0 986 478 506	238	54	12	11	4	TOYOTA
0 986 478 515 *	257,3	59	20	18,2	4	ALFA ROMEO, FIAT, LANCIA
0 986 478 529 *	280	88	22	19	5	MERCEDES-BENZ
0 986 478 530 *	258	84	22	20,4	5	NISSAN
0 986 478 532 *	277	100	26	24	6	FORD, NISSAN
0 986 478 544	257,5	67	16	13	5	VW (VOLKSWAGEN)
0 986 478 547	260	68,2	16	13	5	VW (VOLKSWAGEN)
0 986 478 548 *	280	68,2	24	20	5	VW (VOLKSWAGEN)
0 986 478 555 *	285	120	22	19	6	MERCEDES-BENZ, VW (VOLKSWAGEN)
0 986 478 569	294	68	13,5	12	5	FORD, SEAT, VW (VOLKSWAGEN)
0 986 478 590 *	280	61	24	21,8	4	RENAULT
0 986 478 596 *	257,5	88	22,1	20,6	6	ISUZU, OPEL, VAUXHALL
0 986 478 608	246,7	71	9	7	4	CITROËN, PEUGEOT
0 986 478 613	282	68	18	15	5	VW (VOLKSWAGEN)
0 986 478 618 *	266	66,1	22	20	4	CITROËN, PEUGEOT
0 986 478 629 *	291	100	25	23	6	TOYOTA
0 986 478 635 *	277	87	22	20,4	6	NISSAN
0 986 478 639 *	257,5	59	22	20,2	4	FIAT, LANCIA
0 986 478 643 *	263	102	24	23	5	MERCEDES-BENZ
0 986 478 647	267	58	14,5	12,5	6	IVECO
0 986 478 649	280	58	16	14,8	6	IVECO
0 986 478 658 *	250	80	18	16,6	6	ISUZU, OPEL, VAUXHALL
0 986 478 663 *	254	87	24	22,4	5	HYUNDAI
0 986 478 664 *	253	84	20	18,4	5	HYUNDAI
0 986 478 685 *	250	68	22	20	5	NISSAN

* Innenbelüftete Bremsscheibe
Internal-ventilated brake disc
Disque de frein à ventilation interne
Disco freno areato internamente
Disco de freno ventilado

U** Anzahl der Bohrungen
Number of wholes
Nombre de trous
Quantità dei fori
Cantidad de agujeros

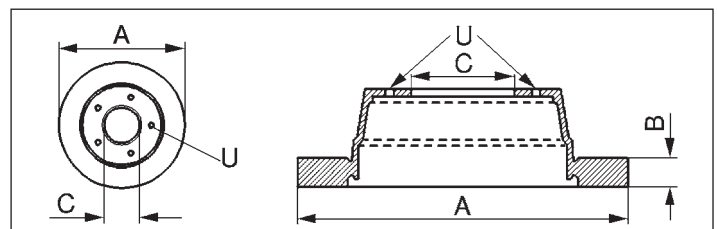

de

Bremsscheiben
(Fortsetzung)

en

Brake discs
(continued)

fr

Disques de freins
(suite)

it

Dischi per freni
(seguito)



es

Discos de freno
(continuación)



	Ø = A	Ø = C	B maximum	B minimum	U **	
	mm	mm	mm	mm		
0 986 478 693 *	285	84	28	26	6	TOYOTA
0 986 478 694 *	280	72	22	20,7	5	JEEP
0 986 478 697 *	268	86	20	18	6	MAZDA
0 986 478 699 *	272	93	22	20	6	MAZDA
0 986 478 706 *	258	84	22	20,4	6	MINI
0 986 478 709 *	250	81	22	20	6	NISSAN
0 986 478 714 *	254	87	24	22,4	5	MINI
0 986 478 730 *	260,5	60	24	21	6	OPEL, VAUXHALL
0 986 478 731	240	57	10	8	4	OPEL, VAUXHALL
0 986 478 739	250,5	62	10	8	6	ALFA ROMEO
0 986 478 741	279	120,3	9	8,1	6	CITROËN
0 986 478 742	267	58	14	12,8	6	ALFA ROMEO, IVECO
0 986 478 745 *	280	78,4	24	21	6	OPEL, RENAULT, VAUXHALL
0 986 478 746	272	108	11	10	5	LADA
0 986 478 755	210,5	70	10	9	4	DAIHATSU
0 986 478 761 *	285	83	20	18,8	8	CITROËN
0 986 478 770 *	280	112	14	12,6	5	PEUGEOT
0 986 478 776	236	62	12,6	10,5	4	SKODA
0 986 478 777 *	288	64,5	20	18,5	5	JAGUAR
0 986 478 802 *	256	86	20,1	18	6	MAZDA
0 986 478 806 *	267	100	20,1	20	6	NISSAN
0 986 478 810 *	284	59	22	20,2	4	ALFA ROMEO, FIAT, LANCIA
0 986 478 817 *	213	55,5	20,6	19	4	AUSTIN, ROVER
0 986 478 820	276	82,5	14,3	12,8	5	LEYLAND-FREIGHT ROVER
0 986 478 821 *	213	55,5	9,5	8,6	4	AUSTIN, ROVER
0 986 478 828 *	239,5	63,5	24,1	22,2	5	FORD
0 986 478 842 *	300	80	24	21,9	5	CITROËN, FIAT, PEUGEOT
0 986 478 843	279,5	73	18	15,9	5	CITROËN, FIAT, PEUGEOT
0 986 478 844 *	276	87	24	22,4	6	MINI
0 986 478 846 *	280	68	24	20	5	VW (VOLKSWAGEN)
0 986 478 847	266	66	13	11	4	CITROËN, PEUGEOT
0 986 478 849 *	276	85	22	19	5	MERCEDES-BENZ, VW (VOLKSWAGEN)
0 986 478 859	236	62	13	11,5	4	SKODA, VW (VOLKSWAGEN)
0 986 478 861 *	276	67	22	19	5	MERCEDES-BENZ
0 986 478 863	258	85	12	10	5	MERCEDES-BENZ, VW (VOLKSWAGEN)
0 986 478 866	238	49	8	7	4	RENAULT
0 986 478 870	282	68	18	15	5	VW (VOLKSWAGEN)
0 986 478 871	280	68	12	10	5	VW (VOLKSWAGEN)
0 986 478 873	280	67	10	8	5	MERCEDES-BENZ
0 986 478 883 *	280	70	25	22	5	OPEL, VAUXHALL
0 986 478 885	290	129,8	22	19	6	IVECO
0 986 478 886	289	128	22	19	8	IVECO
0 986 478 896 *	257,5	59	20	18,2	5	CITROËN, FIAT, PEUGEOT
0 986 478 970	305	90	12	10,5	5	OPEL, RENAULT, VAUXHALL
0 986 478 979 *	283	66	26	24	4	CITROËN, PEUGEOT
0 986 479 001 *	305,5	90	28	25	1	OPEL, RENAULT, VAUXHALL
0 986 479 031 *	300	100	28	26	6	NISSAN
0 986 479 037 *	300	68,15	26	22	5	FORD, SEAT, VW (VOLKSWAGEN)
0 986 479 058 *	312	65	25	22	5	AUDI, SEAT, SKODA, VW (VOLKSWAGEN)
0 986 479 065	280	72	16	14,2	5	CITROËN, FIAT, PEUGEOT
0 986 479 066	280	79	16	14,2	5	CITROËN, FIAT, PEUGEOT



	$\varnothing = A$	$\varnothing = C$	B	B	U**	
	mm	mm	maximum mm	minimum mm		
0 986 479 069 *	278	63	24	22	5	FORD
0 986 479 070	278	63	11	9	5	FORD
0 986 479 077 *	280	60	25	22	4	OPEL, VAUXHALL
0 986 479 078 *	305,5	72	28	24	5	OPEL, RENAULT, VAUXHALL
0 986 479 088 *	288	65	25	22	5	AUDI, SEAT, SKODA, VW (VOLKSWAGEN)
0 986 479 094 *	314	76	22	18	5	VW (VOLKSWAGEN)
0 986 479 096 *	333	76	32,5	28,5	5	VW (VOLKSWAGEN)
0 986 479 097 *	294	76	21,9	19,5	5	VW (VOLKSWAGEN)
0 986 479 098 *	280	65	22	19	9	AUDI, SEAT, SKODA, VW (VOLKSWAGEN)
0 986 479 099	255	65	10	8	9	AUDI, SEAT, SKODA, VW (VOLKSWAGEN)
0 986 479 114 *	285	59,1	28	26	5	CITROËN, FIAT, LANCIA, PEUGEOT
0 986 479 137	300	67	28	25	5	MERCEDES-BENZ
0 986 479 138	296	67	10	8	5	MERCEDES-BENZ
0 986 479 144	280	118	12	10	5	OPEL, RENAULT, VAUXHALL
0 986 479 155	260	65	12	10	9	AUDI, SKODA, VW (VOLKSWAGEN)
0 986 479 161	276	73	16	13	5	IVECO
0 986 479 162	276	73	22	19	5	IVECO
0 986 479 163	276	73	16	13	5	IVECO
0 986 479 191 *	264	57	10	8	4	OPEL
0 986 479 195	280,5	61	12	11	4	RENAULT
0 986 479 211	308	76	29,5	25,5	5	VW (VOLKSWAGEN)
0 986 479 212	285	85	22	19	5	MERCEDES-BENZ
0 986 479 266	280	71	28	26	5	PEUGEOT
0 986 479 271	280	118	12	10	5	OPEL, RENAULT
0 986 479 281	238	68	8	7	4	RENAULT
0 986 479 294	300	85	28	25	6	MERCEDES-BENZ, VW (VOLKSWAGEN)
0 986 479 295	298	85	16	14	6	MERCEDES-BENZ, VW (VOLKSWAGEN)
0 986 479 296	303	120	28	25	6	MERCEDES-BENZ, VW (VOLKSWAGEN)
0 986 479 297	280	73	24	21,9	5	CITROËN, FIAT, PEUGEOT
0 986 479 307	300	93	28	25	5	FORD
0 986 479 313	280	73	28	25,9	5	CITROËN, FIAT, PEUGEOT
0 986 479 314	300	80	24	21,9	5	CITROËN, FIAT, PEUGEOT
0 986 479 315	300	80	32	29,9	5	CITROËN, FIAT, PEUGEOT
0 986 479 316	280	79	16	14,2	5	CITROËN, FIAT, PEUGEOT
0 986 479 317	300	79	16	14,2	5	CITROËN, FIAT, PEUGEOT
0 986 479 342	290	102	26	23	10	RENAULT
0 986 479 343	290	102	22	19	10	RENAULT
0 986 479 355	290	96	26	23	6	NISSAN
0 986 479 356	295,5	68	28	26	6	NISSAN
0 986 479 357	320	68	28	26	6	NISSAN
0 986 479 379	290	71	14	12	5	CITROËN, FIAT, PEUGEOT
0 986 479 380	304	71	28	26	5	CITROËN, FIAT, PEUGEOT

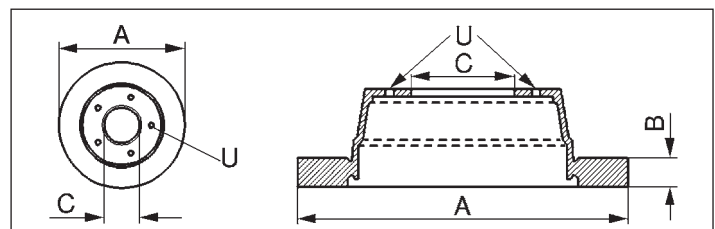

* Innenbelüftete Bremsscheibe
Internal-ventilated brake disc
Disque de frein à ventilation interne
Disco freno areato internamente
Disco de freno ventilado

U** Anzahl der Bohrungen
Number of wholes
Nombre de trous
Quantità dei fori
Cantidad de agujeros



de **Bremsscheiben** (Fortsetzung)
 en **Brake discs** (continued)
 fr **Disques de freins** (suite)
 it **Dischi per freni** (seguito)
 es **Discos de freno** (continuación)



	∅ = A	∅ = C	B	B	U**	
	mm	mm	maximum mm	minimum mm		
0 986 479 383	267	55,5	12	10	4	CITROËN
0 986 479 387	267	55,5	12	10	4	CITROËN, PEUGEOT
0 986 479 389	280	96	16	13	5	FORD
0 986 479 390	280	107,5	16	15	10	FORD
0 986 479 392	280	93	28	25	5	FORD
0 986 479 399	280	72	16	14,2	5	CITROËN, PEUGEOT
0 986 479 401	280	96	16	13	5	FORD
0 986 479 421	312	106	18	16	6	TOYOTA
0 986 479 427	285	84	28	26	5	TOYOTA
0 986 479 469	314	87	24	22,4	6	MITSUBISHI
0 986 479 488	278	95	24	22	6	RENAULT
0 986 479 491	236	62	12,7	11,4	4	SKODA

* Innenbelüftete Bremsscheibe
 Internal-ventilated brake disc
 Disque de frein à ventilation interne
 Disco freno areato internamente
 Disco de freno ventilado

U** Anzahl der Bohrungen
 Number of wholes
 Nombre de trous
 Quantità dei fori
 Cantidad de agujeros

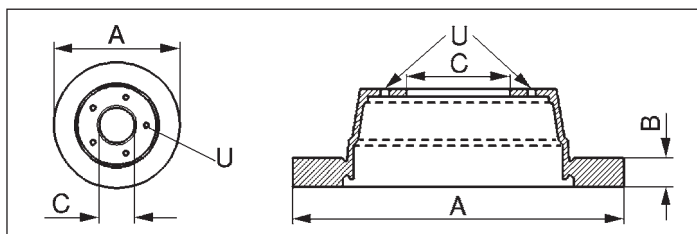

de

Bremstrommeln

en

Brake drums

fr

Tambour de freins

it

Tamburi per freni



es

Tambores de freno



	Ø mm	X mm	U** mm	
0 986 477 011	230	51,3	4	VW (VOLKSWAGEN)
0 986 477 019	180	53,5	4	PEUGEOT
0 986 477 020	180	43	4	CITROËN
0 986 477 022	230	58,5	4	BEDFORD OPEL VAUXHALL
0 986 477 028	228,5	56,5	5	FORD
0 986 477 031	254,5	64	5	CITROËN FIAT PEUGEOT TALBOT
0 986 477 033	252,2	64,5	5	VW (VOLKSWAGEN)
0 986 477 034	252	65	5	VW (VOLKSWAGEN)
0 986 477 035	270	73	6	VW (VOLKSWAGEN)
0 986 477 036	230	48,5	4	VW (VOLKSWAGEN)
0 986 477 038	260	65,5	6	MERCEDES-BENZ STEYR (STEYR-DAIMLER- PUCH AG)
0 986 477 041	200	49,5	4	AUDI SEAT SKODA VW (VOLKSWAGEN)
0 986 477 046	268	67,5	5	VW (VOLKSWAGEN)
0 986 477 047	280	111	6	FORD
0 986 477 048	254	61	5	FORD
0 986 477 055	185	36	4	AUTOBIANCHI FIAT INNOCENTI (NUOVA INNOCENTI) LANCIA SEAT
0 986 477 060	228,7	50,5	4	CITROËN PEUGEOT
0 986 477 061	180	52,5	4	DACIA RENAULT
0 986 477 067	228,6	52,5	4	RENAULT
0 986 477 076	180	52,5	4	RENAULT
0 986 477 085	254,1	81,5	6	FORD
0 986 477 088	228,5	48,5	4	ALFA ROMEO FIAT LANCIA
0 986 477 098	255,6	64,5	5	CITROËN FIAT PEUGEOT
0 986 477 100	230	49,5	4	OPEL VAUXHALL
0 986 477 101	230	43	5	MERCEDES-BENZ
0 986 477 108	203	50,5	4	RENAULT
0 986 477 109	202	51,6	4	ALFA ROMEO FIAT LANCIA



	Ø mm	X mm	U** mm	
0 986 477 112	180	53,5	4	DACIA RENAULT
0 986 477 114	180	43	4	CITROËN PEUGEOT
0 986 477 117	180	83	4	RENAULT
0 986 477 129	228,5	89,5	5	FORD
0 986 477 144	255	85	5	CITROËN FIAT LANCIA PEUGEOT
0 986 477 145	254	75	6	OPEL

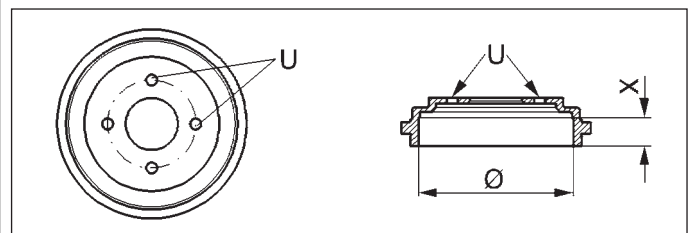

U** Anzahl der Bohrungen
Number of wholes
Nombre de trous
Quantità dei fori
Cantidad de agujeros

de

Trommelbrems-
backen

en

Drum-brake shoes

fr

Mâchoires de freins
à tambour

it

Ganasce per freni
a tamburo

es

Zapatas de frenos
de tambor

0 204 072 233			CHEVROLET
0 986 487 020	180	32	RENAULT
0 986 487 030	185	31	AUTOBIANCHI FIAT INNOCENTI (NUOVA INNOCENTI) LANCIA SEAT ZASTAVA (YUGO)
0 986 487 071	200	46	OPEL
0 986 487 076	228,6	42	PEUGEOT RENAULT VOLVO
0 986 487 081	180	32	RENAULT
0 986 487 084	180	42	PEUGEOT RENAULT
0 986 487 128	254	57	CITROËN FIAT PEUGEOT TALBOT
0 986 487 164	228,6	41	NISSAN
0 986 487 193	252	56	VW (VOLKSWAGEN)
0 986 487 199	200	45	OPEL VAUXHALL
0 986 487 201	230	50	BEDFORD OPEL VAUXHALL
0 986 487 207	250	51	MITSUBISHI
0 986 487 232	229	44,5	LEYLAND-FREIGHT ROVER
0 986 487 242	228,6	45	FORD
0 986 487 255	228,5	42	ALFA ROMEO FIAT
0 986 487 263	200	29	CHEVROLET OPEL VAUXHALL
0 986 487 268	220	40	SUZUKI
0 986 487 269	180	31	SUBARU SUZUKI
0 986 487 270	200	40	AUDI SEAT SKODA VW (VOLKSWAGEN)
0 986 487 272	180	42	RENAULT
0 986 487 273	177,8	32	MITSUBISHI ROVER
0 986 487 274	180	32	CITROËN PEUGEOT
0 986 487 279	252	56	VW (VOLKSWAGEN)
0 986 487 281	230	40	AUDI SEAT VW (VOLKSWAGEN)

0 986 487 283	180	32	RENAULT
0 986 487 285	228,5	42	FIAT
0 986 487 287	254	90	IVECO
0 986 487 289	203,2	39	CITROËN RENAULT
0 986 487 290	254	50	TOYOTA
0 986 487 292	254	56	TOYOTA VW (VOLKSWAGEN)
0 986 487 294	228,6	41	DAIHATSU TOYOTA
0 986 487 300	228,5	40	NISSAN
0 986 487 309	254	70	FORD
0 986 487 312	270	55	VW (VOLKSWAGEN)
0 986 487 313	254	57	FIAT
0 986 487 315	255	57	EBRO (MISA) MERCEDES-BENZ NISSAN
0 986 487 316	270	50	NISSAN
0 986 487 324	220	40	SUZUKI
0 986 487 326	200	32	SKODA
0 986 487 328	254	70	FORD
0 986 487 331	185	31	AUTOBIANCHI FIAT LANCIA
0 986 487 332	255	46	OPEL RENAULT
0 986 487 336	228,5	42	CITROËN
0 986 487 341	255	60	PEUGEOT
0 986 487 347	254	70	IVECO LEYLAND-FREIGHT ROVER
0 986 487 354	295	60	TOYOTA VW (VOLKSWAGEN)
0 986 487 359	260	50	MAZDA
0 986 487 361	270	55	TOYOTA
0 986 487 369	260	50	NISSAN
0 986 487 375	254	90	IVECO
0 986 487 376	254	50	ISUZU
0 986 487 378	255	46	RENAULT
0 986 487 389	270	66	VW (VOLKSWAGEN)
0 986 487 401	280	64	FORD
0 986 487 414	295	50	TOYOTA
0 986 487 419	170	30	SUBARU
0 986 487 427	220	40	BEDFORD SUZUKI
0 986 487 434	254	90	ALFA ROMEO IVECO
0 986 487 435	260	50	MAZDA
0 986 487 440	220	35	HONDA SUZUKI
0 986 487 464	295	50	NISSAN
0 986 487 469	228,5	45	ROVER

de

Verwendungsteil

en

Applications

fr

Affectations

it

Impiego

es

Aplicación

Benutzerhinweise

In diesem Katalog sind die Daten von Fahrzeugen, Motoren und Geräten für den europäischen Markt von Baujahr 1985 bis einschließlich 2009 erfasst. Diese wurden aus Hersteller- und Importeurangaben, aus Fahrzeuguntersuchungen sowie aus Unterlagen von Bosch nach bestem Wissen sorgfältig zusammengestellt und geben den Stand zum Zeitpunkt der Drucklegung wieder.

Zwangsläufige Abweichungen durch länder-spezifische technische Änderungen können nie ganz ausgeschlossen werden. Bosch kann daher insoweit nicht für die Vollständigkeit und Fehlerfreiheit der Daten haften. Für Irrtümer und Druckfehler, die zu Schäden am Eigentum oder Vermögen führen, haftet Bosch nur bei grob fahrlässiger Pflichtverletzung und bei Vorsatz für unmittelbare Schäden. Bei Personenschäden haftet Bosch auch bei leichter Fahrlässigkeit.

Notes for users

This catalog contains the data from the vehicles, engines, and equipment for the European market from year of manufacture 1985 up to and including the year 2009. This data has been assembled from information provided by manufacturers and importers, and taken from Bosch documentation, as well as from investigations made on vehicles. It has been compiled to the best of our knowledge and belief, and reflects the status at the date of going to print.

It is impossible to avoid deviations caused by technical changes resulting from the conditions and regulations applying in a particular country. Bosch can therefore accept no liability for the completeness and faultlessness of the data. In case of mistakes and misprints which result in damage to property or assets, Bosch is only liable for immediate damages insofar as a gross breach of duty or wrongful intent apply. If personal injury is involved, Bosch is liable also in case of ordinary negligence.

A l'attention de l'utilisateur

Le présent catalogue mentionne les données spécifiques de véhicules, moteurs et appareils pour le marché européen depuis l'année de fabrication 1985 jusqu'au millésime 2009 inclus. Ces informations ont été rassemblées soigneusement et en toute impartialité à partir des indications des constructeurs et importateurs, des contrôles techniques des véhicules et de la documentation Bosch, et matérialisent le stade des connaissances au moment de la mise sous presse.

Il n'est jamais possible d'exclure totalement les divergences éventuelles dues aux modifications techniques, spécifiques des différents pays considérés. En aucun cas, Bosch n'engage sa responsabilité en ce qui concerne l'intégralité et l'exactitude des données. En ce qui concerne les erreurs et les fautes d'impression, qui peuvent entraîner des dommages à la propriété ou à la fortune, Bosch n'engage sa responsabilité pour les dommages directs qu'en cas d'atteinte et de négligence graves et intentionnelles envers ses obligations. En cas de dommages causés aux personnes, Bosch engage sa responsabilité aussi en cas de légère négligence.

Avvertenze per la consultazione

Nella seguente parte di catalogo sono contemplati veicoli, motori ed apparecchi a partire dall'anno di costruzione 1985 fino all'anno 2009. Tali informazioni sono state rilevate dalle documentazioni di Case Auto, Importatori, da verifiche eseguite sui veicoli, così come da documentazione Bosch.

Eventuali discordanze dovute a specifiche esigenze del Paese e variazioni tecniche non possono essere previste. Per questo Bosch non si assume alcuna responsabilità per mancanze ed eventuali errori riferite ai dati. Per danni a cose o danni patrimoniali, dovuti ad errori o refusi di stampa, Bosch è responsabile solo in caso di dolo o colpa grave. Per danni alla persona, Bosch è responsabile anche in caso di colpa meno grave.

Avertencia al usuario

Los datos de este catálogo para vehículos, motores y utensilios del mercado europeo comprenden los años de construcción desde 1985 hasta 2009 inclusive. Éstos son creados para la edición indicada sobre la base de documentos de Bosch, exámenes o inspecciones de vehículos así como datos de fabricantes e importadores.

No obstante, y debido al cuantioso material de información, no se puede excluir la posibilidad de modificaciones, diferencias propias de variantes específicas de los países, fallos, equivocaciones o errores. En caso de inexactitudes y errores de imprenta, la responsabilidad de Bosch se limita al daño inmediato, con exclusión de un daño puramente patrimonial, a no ser que el daño previsible y típico del contrato sea de mayor monto o se debe a dolo o culpa intencional o a negligencia grave.

Hinweise zur Benutzung

- ① Fahrzeughersteller
- ② Modellangaben
- ③ Hubraum in l
- ④ Motorleistung in kW
- ⑤ Fahrgestellnummer bzw. Motortyp
- ⑥ Einbaue Zeitraum des Produktes
- ⑦ Sonderfälle
- ⑧ Bildzeichenerläuterung
- ⑨ Bremsscheiben (innenbelüftet)
- ⑩ Maßangabe
- ⑪ Bremssystem
- ⑫ Scheibenbremsbeläge (10-stellige Bestellnummer)
- ⑬ Maßangabe
- ⑭ WVA-Nummer
- ⑮ Zubehorsatz
- ⑯ Warnkontakt
 - vorbereitet
 - mitgeliefert

B2 | ALFA ROMEO

0 986... 0 986... 1 987... 1 987...									
ALFA ROMEO									
①									
②	AR8 35 Turbo	2,5	68	04.85-12.88	478 742	267/14			
	40 Turbo	2,5	68	04.85-12.88	478 742	267/14			
AUSTIN B									
Maestro 500/700									
	1.3 City L	1,3	45	09.84-08.88	GIR	424 151	21 084		
	1.6 City L	1,6	63	09.84-08.88	GIR	424 151	21 084		
	2.0 City L	2,0	45	09.84-08.88	GIR	424 151	21 084		
③	Metro 310 1.0 City L	1,0	50	08.83-08.88	DEP	424 093	20 762	474 178	
	Fg.no. XF 400202 → XF 944211			08.83-08.88	MFL	478 817	213/20,6		
	Fg.no. 300000 → 145347			08.83-08.88	MFL	478 821	213/9,5		
④	Fg.no. XF 400202 → XF 944211			08.83-08.88	MFL	478 817	213/20,6	DEP	424 093 20 762 474 178
	Fg.no. 300000 → 145347			08.83-08.88	MFL	478 821	213/9,5		
	310 1.3 City L	1,3	68	08.83-08.88	DEP	424 093	20 762	474 178	
	Fg.no. XF 400202 → XF 944211			08.83-08.88	MFL	478 817	213/20,6		
	Fg.no. 300000 → 145347			08.83-08.88	MFL	478 821	213/9,5		
	72			08.83-08.88	(DEP)	424 093	20 762	474 178	
⑤	Fg.no. 300000 → 145347			08.83-08.88	MFL	478 821	213/9,5		
BEDFORD									
Astra 1.3									
	1.3	1,3	54	08.84-10.89	ERH	478 081	236/12,6	GMC	465 141 (15,6) 20 939
	1.4	1,4	55	09.89-09.91	ERH	478 081	236/12,6	GMC	465 141 15,6 20 939
	1.6	1,6	60	08.84-09.91		478 081	236/12,6	GMC	465 141 15,6 20 939
	1.6D	1,6	39	08.84-12.88		478 192	236/20	GMC	465 141 15,6 (20 939)
	1.7D	1,7	42	01.89-09.91		478 081	236/12,6	GMC	465 141 15,6 20 939
	Astramax 1.3	1,3	54	08.84-10.89		478 080	236/10	GMC	465 141 15,6 20 939
	1.6	1,6	60	09.85-09.93	ERH	478 081	236/12,6		
⑥	1.6D	1,6	39	08.84-12.88	ERH	478 192	236/20	GMC	465 141 15,6 20 939
	1.7D	1,7	42	01.89-09.93	ERH	478 081	236/12,6	GMC	465 141 15,6 20 939
⑦						478 192	236/20	GMC	465 141 15,6 20 939
CHEVROLET									
Corsa Pick-Up 1.7 D									
	1.7 D	1,7	44	12.95-02.03					474 179
	KL					478 192	236/20	ATE	460 938 21 353
	KLO					478 081	236/12,6	ATE	460 938 21 353

en

How to use this catalogue

fr

Consignes d'utilisation

it

Istruzioni d'uso

es

Indicaciones para la utilización

① Vehicle brand	① Marque de véhicule	① Marca del veicolo	① Marca de vehículo
② Details of model	② Spécification modèle	② Applicazioni	② Aplicación
③ Engine displacement in <i>l</i>	③ Cylindrée en <i>l</i>	③ Cilindrata in <i>l</i>	③ Cilindrada en <i>l</i>
④ Engine output in kW	④ Puissance du moteur en kW	④ Potenza motore in kW	④ Potencia del motor en kW
⑤ Chassis number or engine type	⑤ Numéros châssis/ moteur	⑤ N° di telaio o tipo di motore	⑤ Número de chasis o número de motor
⑥ Mounting period	⑥ Période de montage	⑥ Data di produzione	⑥ Fecha de montaje
⑦ Special cases	⑦ Cas particuliers	⑦ Casi particolari	⑦ Casos especiales
⑧ Explanation of symbols	⑧ Légende des symboles	⑧ Legenda del simboli	⑧ Explicación de símbolo gráfico
⑨ Brake discs (internally-ventilated)	⑨ Disques de freins (à ventilation interne)	⑨ Dischi per freni (autoventilati)	⑨ Discos de freno (ventilación interior)
⑩ Dimensions	⑩ Dimensions	⑩ Dimensioni	⑩ Dimensiones
⑪ Braking system	⑪ Système de freinage	⑪ Sistemi frenanti	⑪ Sistema de frenos
⑫ Disc-brake pads (10-digit part number)	⑫ Plaquettes de freins à disque (Références à 10 chiffres)	⑫ Pastiglie per freni a disco (codice ordinazione a 10 cifre)	⑫ Pastillas de frenos de disco (ref. de pedido de 10 cifras)
⑬ Dimensions	⑬ Dimensions	⑬ Dimensioni	⑬ Dimensiones
⑭ WVA-number	⑭ No. WVA	⑭ Numero WVA	⑭ Número WVA
⑮ Accessory set	⑮ Kit d'accessoires	⑮ Kit serie parti	⑮ Kit accesorios
⑯ Wear contact ○ prepared ● included	⑯ Temoins d'usure ○ décrochement ● inclusivement	⑯ Rilevatori d'usura ○ dispositivo ● compreso	⑯ Testigo de desgaste ○ preparada ● incluido

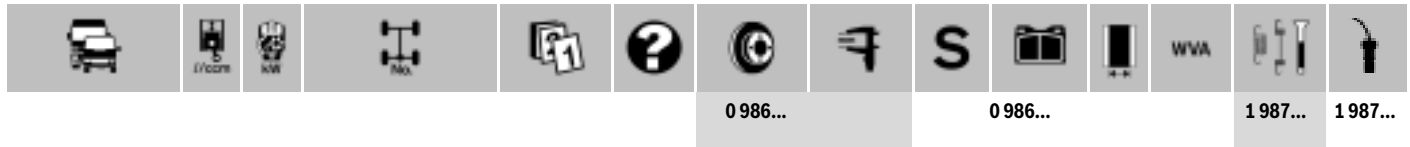

				0986...	0986...				1987...	1987...
ALFA ROMEO										
AR 8 35 Turbo	2,5	68	04.85-12.88	478 742	267 / 14					
40 Turbo	2,5	68	04.85-12.88	478 742	267 / 14					

AUSTIN											
Maestro 500/700	1,3	45	09.84-08.88			GIR	424 151	21 084			
1.3 City L		50	09.84-08.88			GIR	424 151	21 084			
1.6 City L	1,6	63	09.84-08.88			GIR	424 151	21 084			
2.0 City L	2,0	45	09.84-08.88			GIR	424 151	21 084			
Metro 310 1.0 City L	1,0	50	Fg.no. XF 400202→ XF 944211	08.83-08.88	MFL	478 817	213 / 20,6				
			Fg.no. 300000→ 145347	08.83-08.88	MFL	478 821	213 / 9,5				
		54	Fg.no. XF 400202→ XF 944211	08.83-08.88	MFL	478 817	213 / 20,6	DEP	424 093	20 762	474 178
			Fg.no. 300000→ 145347	08.83-08.88	MFL	478 821	213 / 9,5				
310 1.3 City L	1,3	68	Fg.no. XF 400202→ XF 944211	08.83-08.88	MFL	478 817	213 / 20,6	DEP	424 093	20 762	474 178
			Fg.no. 300000→ 145347	08.83-08.88	MFL	478 821	213 / 9,5				
		72	Fg.no. XF 400202→ XF 944211	08.83-08.88	MFL	478 817	213 / 20,6	DEP	424 093	20 762	474 178
			Fg.no. 300000→ 145347	08.83-08.88	MFL	478 821	213 / 9,5				

BEDFORD										
Astra 1.3	1,3	54	08.84-10.89	ERH	478 081	236 / 12,6	GMC	465 141	15,6	20 939
1.4	1,4	55	09.89-09.91	ERH	478 081	236 / 12,6	GMC	465 141	15,6	20 939
1.6	1,6	60	08.84-09.91		478 081	236 / 12,6	GMC	465 141	15,6	20 939
					478 192	236 / 20	GMC	465 141	15,6	20 939
1.6 D	1,6	39	08.84-12.88		478 081	236 / 12,6	GMC	465 141	15,6	20 939
					478 192	236 / 20	GMC	465 141	15,6	20 939
1.7 D	1,7	42	01.89-09.91		478 081	236 / 12,6	GMC	465 141	15,6	20 939
					478 192	236 / 20	GMC	465 141	15,6	20 939
Astramax 1.3	1,3	54	08.84-10.89		478 080	236 / 10	GMC	465 141	15,6	20 939
				ERH	478 081	236 / 12,6				
1.6	1,6	60	09.85-09.93	ERH	478 081	236 / 12,6				
					478 192	236 / 20	GMC	465 141	15,6	20 939
1.6 D	1,6	39	08.84-12.88	ERH	478 081	236 / 12,6	GMC	465 141	15,6	20 939
					478 192	236 / 20	GMC	465 141	15,6	20 939
1.7 D	1,7	42	01.89-09.93	ERH	478 081	236 / 12,6	GMC	465 141	15,6	20 939
					478 192	236 / 20	GMC	465 141	15,6	20 939

CHEVROLET										
Corsa Pick-Up 1.7 D	1,7	44	12.95-02.03							474 179
					KL	478 192	236 / 20	ATE	460 938	21 353
					KLO	478 081	236 / 12,6	ATE	460 938	21 353



0 986... 0 986... 1 987... 1 987...

CITROEN

Berlingo 1.8i	1,8	74	10.99-12.03	BO,D26 OFD	478 618	266 / 22						
							BSY	494 027	19	23 599		
					478 268	265,8 / 20,5						
					478 847	266 / 13	GIR	424 414	19	23 124		
			Org.no. →9127	10.99-11.01	INB		GIR	424 414	19	23 124		
			Org.no. 9128→	12.01-12.03	INB		GIR	424 583	19	23 346		
[B9] 1.6 HDi	1,6	55	05.08→		478 979	283 / 26						
		66	05.08→		478 979	283 / 26						
		80	05.08→		478 979	283 / 26						
1.6 i 16V	1,6	66	05.08→		478 979	283 / 26						
		80	05.08→		478 979	283 / 26						
[M49] Electrique		24	10.98-11.02	BO	478 618	266 / 22	BSY	494 027	19	23 599		
					478 847	266 / 13	GIR	424 414	19	23 124		
			Org.no. →9127	10.98-11.01	GIR	478 268	265,8 / 20,5	GIR	424 414	19	23 124	
			Org.no. 9128→	12.01-11.02	GIR	478 268	265,8 / 20,5	GIR	424 583	19	23 346	
1.1 i	1,1	44	07.96-11.02		478 847	266 / 13	GIR	424 414	19	23 124		
1.4	1,4	51	10.96-11.02		478 847	266 / 13	GIR	424 414	19	23 124		
1.4 i	1,4	55	07.96-11.02		478 847	266 / 13	GIR	424 414	19	23 124		
1.6 i 16V	1,6	80	06.00-11.02				BSY	494 027	19	23 599		
				BO	478 618	266 / 22						
					478 847	266 / 13	GIR	424 414	19	23 124		
			Org.no. →9127	06.00-11.01	GIR	478 268	265,8 / 20,5	GIR	424 414	19	23 124	
			Org.no. 9128→	12.01-11.02	GIR	478 268	265,8 / 20,5	GIR	424 583	19	23 346	
1.8 D	1,8	43-44	07.96-11.02	BO	478 618	266 / 22	BSY	494 027	19	23 599		
					478 847	266 / 13	GIR	424 414	19	23 124		
			Org.no. →9127	07.96-11.01	GIR	478 268	265,8 / 20,5	GIR	424 414	19	23 124	
			Org.no. 9128→	12.01-11.02	GIR	478 268	265,8 / 20,5	GIR	424 583	19	23 346	
1.8 i	1,8	66	03.97-11.02	BO	478 618	266 / 22	BSY	494 027	19	23 599		
				INO			GIR	424 414	19	23 124		
			Org.no. →9127	03.97-11.01	GIR	478 268	265,8 / 20,5	GIR	424 414	19	23 124	
			Org.no. 9128→	12.01-11.02	GIR	478 268	265,8 / 20,5	GIR	424 583	19	23 346	
1.9 D	1,9	50-51	07.96-11.02	BO	478 618	266 / 22	BSY	494 027	19	23 599		
				INO			GIR	424 414	19	23 124		
			Org.no. →9127	07.96-11.01	GIR	478 268	265,8 / 20,5	GIR	424 414	19	23 124	
			Org.no. 9128→	12.01-11.02	GIR	478 268	265,8 / 20,5	GIR	424 583	19	23 346	
		52	07.98-11.02	BO	478 618	266 / 22	BSY	494 027	19	23 599		
			Org.no. →9127	07.98-11.01	GIR	478 268	265,8 / 20,5	GIR	424 414	19	23 124	
			Org.no. 9128→	12.01-11.02	GIR	478 268	265,8 / 20,5	GIR	424 583	19	23 346	
2.0 HDi	2,0	66	12.99-11.02	BO	478 618	266 / 22	BSY	494 027	19	23 599		
			Org.no. →9127	12.99-11.01	GIR	478 268	265,8 / 20,5	GIR	424 414	19	23 124	
			Org.no. 9128→	12.01-11.02	GIR	478 268	265,8 / 20,5	GIR	424 583	19	23 346	
[M59] Electrique		28	11.02→		478 618	266 / 22	BSY	494 027	19	23 599		
1.1 i	1,1	44	11.02→		478 618	266 / 22	BSY	494 027	19	23 599		
1.4 i	1,4	55	11.02→		478 618	266 / 22	BSY	494 027	19	23 599		
1.6 HDi	1,6	55	09.05→		478 618	266 / 22	BSY	494 027	19	23 599		



				0986...	0986...	1987...	1987...				
◀ CITROEN											
Berlingo [M59]	1,6	66		09.05→	MFD	478 979	283 / 26	BSY	494 038	19	23 600
1.6 HDi					OFD	478 618	266 / 22	BSY	494 027	19	23 599
1.6 i 16V	1,6	80		11.02→	MFD	478 979	283 / 26	BSY	494 038	19	23 600
					OFD	478 618	266 / 22	BSY	494 027	19	23 599
1.9 D	1,9	52		11.02→		478 618	266 / 22	BSY	494 027	19	23 599
2.0 HDi	2,0	66		11.02→	MFD	478 979	283 / 26	BSY	494 038	19	23 600
					OFD	478 618	266 / 22	BSY	494 027	19	23 599
C 25 E 1.8	1,8	49-51		11.81-03.94	L02			GIR	460 998	19,5	21 205
				05.84-03.94	L02	478 234	290 / 16				
			Org.no. →155247	11.81-03.94	L03	478 067	257 / 12	GIR	467 411	19	20 741
			Org.no. 155248→	01.83-03.94	L03	478 200	255 / 16	GIR	467 411	19	20 741
25 E 2.0	2,0	55-60		09.81-03.94	L02			GIR	460 998	19,5	21 205
				05.84-03.94	L02	478 234	290 / 16				
			Org.no. →155247	09.81-03.94	L03	478 067	257 / 12	GIR	467 411	19	20 741
			Org.no. 155248→	01.83-03.94	L03	478 200	255 / 16	GIR	467 411	19	20 741
		60-63		09.81-03.94	L02			GIR	460 998	19,5	21 205
				05.84-03.94	L02	478 234	290 / 16				
			Org.no. →155247	09.81-03.94	L03	478 067	257 / 12	GIR	467 411	19	20 741
			Org.no. 155248→	01.83-03.94	L03	478 200	255 / 16	GIR	467 411	19	20 741
25 1.9 D	1,9	51		07.87-03.94	L02			GIR	460 998	19,5	21 205
					L02	478 234	290 / 16				
			Org.no. →155247	07.87-03.94	L03	478 067	257 / 12	GIR	467 411	19	20 741
			Org.no. 155248→	07.87-03.94	L03	478 200	255 / 16	GIR	467 411	19	20 741
25 1.9 D Turbo	1,9	60		04.92-03.94		478 234	290 / 16	GIR	460 998	19,5	21 205
25 2.5 D	2,5	54-55		07.81-03.94	L02			GIR	460 998	19,5	21 205
				05.84-03.94	L02	478 234	290 / 16				
			Org.no. →155247	07.81-03.94	L03	478 067	257 / 12	GIR	467 411	19	20 741
			Org.no. 155248→	01.83-03.94	L03	478 200	255 / 16	GIR	467 411	19	20 741
25 2.5 D Turbo	2,5	70		08.87-03.94		478 234	290 / 16	GIR	460 998	19,5	21 205
35 2.5 D	2,5	50		01.80-12.92		478 761	285 / 20	CIT	424 069		20 655
C 15 E 1.0	1,0	32	Org.no. →4195	11.86-05.88		478 052	244,5 / 8,9	CIT	465 941		20 594
			Org.no. 4196→	06.88-12.97		478 046	247,5 / 10	GIR	490 800	17,6	21 080
E 1.1	1,1	35	Org.no. →4195	10.84-07.87		478 052	244,5 / 8,9	CIT	465 941		20 594
		35-40		07.87-07.88		478 046	247,5 / 10	GIR	490 800	17,6	21 080
		44		07.88-12.96		478 046	247,5 / 10	GIR	490 800	17,6	21 080
i	1,1	44		06.89-12.96		478 046	247,5 / 10	GIR	490 800	17,6	21 080
E 1.3	1,3	47		07.87-07.88		478 046	247,5 / 10	GIR	490 800	17,6	21 080
E 1.4	1,4	40-46	Org.no. →4195	07.87-05.88		478 052	244,5 / 8,9	CIT	465 941		20 594
			Org.no. 4196→	06.88-12.96		478 046	247,5 / 10	GIR	490 800	17,6	21 080
		44	Org.no. →4195	07.86-07.87		478 052	244,5 / 8,9	CIT	465 941		20 594
		50-51	Org.no. →4195	07.86-07.87		478 052	244,5 / 8,9	CIT	465 941		20 594
		51	Org.no. →4195	07.87-05.88		478 052	244,5 / 8,9	CIT	465 941		20 594
			Org.no. 4196→	06.88-12.96		478 046	247,5 / 10	GIR	490 800	17,6	21 080
		55		05.91-12.96		478 046	247,5 / 10	GIR	490 800	17,6	21 080
E 1.4 i	1,4	55-58		01.92-12.96		478 046	247,5 / 10	GIR	490 800	17,6	21 080
1.8 D	1,8	44		07.86-05.00		478 046	247,5 / 10	GIR	490 800	17,6	21 080
1.9 D	1,9	52		06.00-12.05		478 046	247,5 / 10	BSY	460 983	17,8	20 986
Jumper 2.8	2,8	63		01.02-08.05	L02	478 842	300 / 24	BRB	424 769	19,1	23 919
					L02	478 842	300 / 24	GIR	424 031	19,6	21 800
					L03	478 843	279,5 / 18	GIR	424 030	19,5	21 797
					L03	479 297	280 / 24		494 048	18,3	23 917
2.8 HDi	2,8	93		09.05→	L02	478 842	300 / 24	BRB	424 769	19,1	23 919
					L02	478 842	300 / 24	GIR	424 031	19,6	21 800
					L03	478 843	279,5 / 18	GIR	424 030	19,5	21 797
					L03	479 297	280 / 24		494 048	18,3	23 917
2.8 T	2,8	77		12.01-08.05	L02	478 842	300 / 24	BRB	424 769	19,1	23 919
					L02	478 842	300 / 24	GIR	424 031	19,6	21 800
					L03	478 843	279,5 / 18	GIR	424 030	19,5	21 797
					L03	479 297	280 / 24	GIR	424 030	19,5	21 797
[U5] 2.0 HDi	2,0	62		02.02→	L02	478 842	300 / 24	BRB	424 769	19,1	23 919
					L03	479 297	280 / 24		494 048	18,3	23 917
2.0 i	2,0	80		02.02→	L02	478 842	300 / 24	BRB	424 769	19,1	23 919
					L03	479 297	280 / 24		494 048	18,3	23 917

								0 986...		0 986...		1 987...		1 987...		
Jumper [U5]	2,2 74	02.02→	L02	▮	478 842	300 / 24	BRB	424 769	19,1	23 919						
			L03	▮	479 297	280 / 24		494 048	18,3	23 917						
2.8 D Turbo	2,8 90	02.02→	L02	▮	478 842	300 / 24	BRB	424 769	19,1	23 919						
			L03	▮	479 297	280 / 24		494 048	18,3	23 917						
2.8 HDi	2,8 94	02.02→	L02	▮	478 842	300 / 24	BRB	424 769	19,1	23 919						
			L03	▮	479 297	280 / 24		494 048	18,3	23 917						
	107	08.04→	L02	▮	478 842	300 / 24	BRB	424 769	19,1	23 919						
			L03	▮	479 297	280 / 24		494 048	18,3	23 917						
[U9] 2.2 HDi	2,2 74	06.06→		▮	479 315	300 / 32	BRB	494 109	19	24466						
				▮	479 314	300 / 24	BRB	494 109	19	24466						
				▮	479 313	280 / 28	BRB	494 111	19,1	24468						
				▮	479 297	280 / 24	BRB	494 111	19,1	24468						
	88	06.06→		▮	479 315	300 / 32	BRB	494 109	19	24466						
				▮	479 314	300 / 24	BRB	494 109	19	24466						
				▮	479 313	280 / 28	BRB	494 111	19,1	24468						
				▮	479 297	280 / 24	BRB	494 111	19,1	24468						
3.0 HDi	3,0 115	06.06→		▮	479 315	300 / 32	BRB	494 109	19	24466						
				▮	479 314	300 / 24	BRB	494 109	19	24466						
				▮	479 313	280 / 28	BRB	494 111	19,1	24468						
				▮	479 297	280 / 24	BRB	494 111	19,1	24468						
[23] 1.9 D	1,9 51	02.94-02.02	L02	▮	478 842	300 / 24	GIR	424 031	19,6	21 800						
			L03	▮	478 434	280 / 24	GIR	424 030	19,5	21 797						
			L03	▮	478 843	279,5 / 18	GIR	424 030	19,5	21 797						
1.9 D Turbo	1,9 66-68	02.94-02.02	L02	▮	478 842	300 / 24	GIR	424 031	19,6	21 800						
			L03	▮	478 434	280 / 24	GIR	424 030	19,5	21 797						
			L03	▮	478 843	279,5 / 18	GIR	424 030	19,5	21 797						
2.0	2,0 79	02.94-02.02	L02	▮	478 842	300 / 24	GIR	424 031	19,6	21 800						
			L03	▮	478 434	280 / 24	GIR	424 030	19,5	21 797						
			L03	▮	478 843	279,5 / 18	GIR	424 030	19,5	21 797						
2.0 HDi	2,0 62	03.01-02.02	L02	▮	478 842	300 / 24	GIR	424 031	19,6	21 800						
			L03	▮	478 434	280 / 24	GIR	424 030	19,5	21 797						
			L03	▮	478 843	279,5 / 18	GIR	424 030	19,5	21 797						
2.0 i	2,0 80	02.94-02.02	L02	▮	478 842	300 / 24	GIR	424 031	19,6	21 800						
			L03	▮	478 434	280 / 24	GIR	424 030	19,5	21 797						
			L03	▮	478 843	279,5 / 18	GIR	424 030	19,5	21 797						
2.5 D	2,5 63	02.94-02.02	L02	▮	478 842	300 / 24	GIR	424 031	19,6	21 800						
			L03	▮	478 434	280 / 24	GIR	424 030	19,5	21 797						
			L03	▮	478 843	279,5 / 18	GIR	424 030	19,5	21 797						
2.5 D Turbo	2,5 76	02.94-02.02	L02	▮	478 842	300 / 24	GIR	424 031	19,6	21 800						
			L03	▮	478 434	280 / 24	GIR	424 030	19,5	21 797						
			L03	▮	478 843	279,5 / 18	GIR	424 030	19,5	21 797						
2.5 TDi	2,5 79	10.96-02.02	L02	▮	478 842	300 / 24	GIR	424 031	19,6	21 800						
			L03	▮	478 434	280 / 24	GIR	424 030	19,5	21 797						
			L03	▮	478 843	279,5 / 18	GIR	424 030	19,5	21 797						
2.8 D	2,8 64	01.99-02.02	L02	▮	478 842	300 / 24	GIR	424 031	19,6	21 800						
			L03	▮	478 434	280 / 24	GIR	424 030	19,5	21 797						
			L03	▮	478 843	279,5 / 18	GIR	424 030	19,5	21 797						
2.8 D Turbo	2,8 90	10.99-02.02	L02	▮	478 842	300 / 24	GIR	424 031	19,6	21 800						
			L03	▮	478 434	280 / 24	GIR	424 030	19,5	21 797						
			L03	▮	478 843	279,5 / 18	GIR	424 030	19,5	21 797						
2.8 HDi	2,8 94	09.00-02.02	L02	▮	478 842	300 / 24	GIR	424 031	19,6	21 800						
			L03	▮	478 434	280 / 24	GIR	424 030	19,5	21 797						
			L03	▮	478 843	279,5 / 18	GIR	424 030	19,5	21 797						
Jumpy [G9] 1.6 HDi	1,6 66	02.07→		▮	479 380	304 / 28										
			2.0 HDi	2,0 88	02.07→		▮	479 380	304 / 28							
2.0 i 16V	2,0 103	02.07→		▮	479 380	304 / 28										
[U64] 1.6 i	1,6 58	10.95→	BSY	▮	478 896	257,5 / 20	BSY	424 415	18,5	23 042			474 199			
			GIR	▮	478 812	280,6 / 26	GIR	424 033	19,3	21 801						
1.9 D	1,9 50-52	10.95→	BSY	▮	478 896	257,5 / 20	BSY	424 415	18,5	23 042			474 199			
			GIR	▮	478 812	280,6 / 26	GIR	424 033	19,3	21 801						
	51	10.98-08.01	BSY	▮	478 896	257,5 / 20	BSY	424 415	18,5	23 042			474 199			
			GIR	▮	478 812	280,6 / 26	GIR	424 033	19,3	21 801						



				0986...	0986...			1987...	1987...	
◀ CITROEN										
Jumpy [U64] 1.9D	1,9	52	09.01→	BSY	₺ 478 896	257,5 / 20	BSY	424 415	18,5 23 042	474 199
				GIR	₺ 478 812	280,6 / 26	GIR	424 033	19,3 21 801	
1.9D Turbo	1,9	66	10.95→	BSY	₺ 478 896	257,5 / 20	BSY	424 415	18,5 23 042	474 199
				GIR	₺ 478 812	280,6 / 26	GIR	424 033	19,3 21 801	
		67-68	10.95→	BSY	₺ 478 896	257,5 / 20	BSY	424 415	18,5 23 042	474 199
				GIR	₺ 478 812	280,6 / 26	GIR	424 033	19,3 21 801	
2.0Hdi	2,0	70	10.99→	BSY	₺ 478 896	257,5 / 20	BSY	424 415	18,5 23 042	474 199
				GIR	₺ 478 812	280,6 / 26	GIR,	424 033	19,3 21 801	
				LUC	₺ 479 114	285 / 28	GIR,	424 789	19,3 20 261	
				LUC			GIR,	424 789	19,3 20 261	
		80	10.99→	BSY	₺ 478 896	257,5 / 20	BSY	424 415	18,5 23 042	474 199
				GIR	₺ 478 812	280,6 / 26	GIR	424 033	19,3 21 801	
				LUC	₺ 479 114	285 / 28	GIR,	424 789	19,3 20 261	
				LUC			GIR,	424 789	19,3 20 261	
		81	06.00→	BSY	₺ 478 896	257,5 / 20	BSY	424 415	18,5 23 042	474 199
				GIR	₺ 478 812	280,6 / 26	GIR,	424 033	19,3 21 801	
				LUC	₺ 479 114	285 / 28	GIR,	424 789	19,3 20 261	
				LUC			GIR,	424 789	19,3 20 261	
2.0i	2,0	100	04.00→	BSY	₺ 478 896	257,5 / 20	BSY	424 415	18,5 23 042	474 199
				GIR	₺ 478 812	280,6 / 26	GIR	424 033	19,3 21 801	
				LUC	₺ 479 114	285 / 28	GIR,	424 789	19,3 20 261	
				LUC			GIR,	424 789	19,3 20 261	
Nemo [A9] 1.4 Hdi	1,4	50	02.08→	GS			BSY	494 113	18 23982	
				SEG			BSY	424 596	19 23 708	
1.4i	1,4	54	02.08→				BSY	494 113	18 23982	
DACIA										
Duster 1.4 4WD	1,4	0	06.84-12.95				BSY	461 396	14 20 347	
DAIHATSU										
Cab Van 1.0	1,0	33	01.85-12.87		₺ 478 755	210,5 / 10				
1.0 4WD	1,0	33	10.85-12.87		₺ 478 755	210,5 / 10				
Hijet 1.0	1,0	33	01.84-04.86		₺ 478 755	210,5 / 10				
			05.86-11.92				SUM	424 099	13,4 20 780	
1.0 4WD	1,0	33	05.86-11.92				SUM	424 099	13,4 20 780	
850	0,9		05.86-11.92				SUM	424 099	13,4 20 780	
Hijet Pick-up 1.0	1,0	33	12.92-05.98				SUM	424 099	13,4 20 780	
1.0i	1,0	35	07.94-05.98				SUM	424 099	13,4 20 780	
1.3 16V	1,3	48	05.98→				SUM	424 099	13,4 20 780	
Hijet Van 1.0	1,0	33	12.92-05.98				SUM	424 099	13,4 20 780	
1.0i	1,0	35	03.95-05.98				SUM	424 099	13,4 20 780	
1.3 16V	1,3	48	05.98→				SUM	424 099	13,4 20 780	
Mira Van 0.7	0,7	29	08.94-12.94				AKE	424 642	14 21 968	
0.7i	0,7	33-35	10.98-12.02				SUM	424 643	14,5 23 494	
FIAT										
Cityvan [257..] 1.1	1,1	43	01.85-08.89		₺ 478 353	240,5 / 12				
				BVA			ATE	424 178	21 195	
				OVA			ATE	460 986	18 21 193	

				0 986...		0 986...		1 987...		1 987...	
Cityvan [257..]	1.7 D	1,7	44	01.85-08.89							
					BVA		ATE	424 178		21 195	
					OVA		ATE	460 986	18	21 193	
Doblo Cargo [223..]	1.2 i.e. 8V	1,2	47	07.00-09.05			GIR	424 646	15	23 417	
1.3 JTD	1,2	55		10.05-01.08	KOB,NNC			494 074	19	23 708	
				10.05→	KOB,NNC	478 810	284 / 22				
					KOB,VFC	478 639	257,5 / 22				
				Ricam.no →5749151	10.05→	KOB,VAN, VFC		BSY	424 597	17,8	23 705
		62		10.05-01.08	KOB,NNC			494 074	19	23 708	
				10.05→	KOB,NNC	478 810	284 / 22				
					KOB,VFC	478 639	257,5 / 22				
				Ricam.no →5749151	10.05→	KOB,VAN, VFC		BSY	424 597	17,8	23 705
1.3 JTD 16V	1,2	51		02.04-09.05			GIR	424 646	15	23 417	
						478 515	257,3 / 20				
1.4 i.e.	1,4	57		10.05-01.08	KOB,NNC			494 074	19	23 708	
				10.05→	KOB,NNC	478 810	284 / 22				
					KOB,VFC	478 639	257,5 / 22				
				Ricam.no →5749151	10.05→	KOB,VAN, VFC		BSY	424 597	17,8	23 705
1.6 i.e. 16V	1,6	76		10.01-09.05		478 515	257,3 / 20	GIR	424 646	15	23 417
i.e. 16V Bipower	1,6	68-76		01.03-09.05		478 515	257,3 / 20	GIR	424 646	15	23 417
		76		10.05→		478 639	257,5 / 22	BSY	424 597	17,8	23 705
1.9 D	1,9	46		07.00-09.05		478 515	257,3 / 20	GIR	424 646	15	23 417
1.9 JTD	1,9	74		10.01-01.04		478 515	257,3 / 20	GIR	424 646	15	23 417
				10.05→		478 639	257,5 / 22	BSY	424 597	17,8	23 705
		77		11.02-09.05		478 515	257,3 / 20	GIR	424 646	15	23 417
				10.05-01.08	KOB,NNC			494 074	19	23 708	
				10.05→	KOB,NNC	478 810	284 / 22				
					KOB,VFC	478 639	257,5 / 22				
				Ricam.no →5749151	10.05→	KOB,VAN, VFC		BSY	424 597	17,8	23 705
		88		10.05-01.08	KOB,NNC			494 074	19	23 708	
				10.05→	KOB,NNC	478 810	284 / 22				
					KOB,VFC	478 639	257,5 / 22				
				Ricam.no →5749151	10.05→	KOB,VAN, VFC		BSY	424 597	17,8	23 705
Ducato 2.5 D	2,5	62		11.97-05.05		478 843	279,5 / 18				
2.8 D	2,8	63		04.00-05.05		478 434	280 / 24	GIR	424 556	19,6	23 602
2.8 D Turbo	2,8	90		04.00-04.02		478 434	280 / 24	GIR	424 556	19,6	23 602
				05.02-05.05					494 048	18,3	23 917
2.8 D Turbo Interc.	2,8	103,3		10.00-04.02		478 434	280 / 24	GIR	424 556	19,6	23 602
				10.00-05.05		478 842	300 / 24		494 048	18,3	23 917
								BRB	424 769	19,1	23 919
Ducato Cargo 2.5 D	2,5	62		11.97-05.05		478 842	300 / 24	GIR	424 031	19,6	21 800
2.8 D	2,8	63		04.00-05.05		478 842	300 / 24	GIR	424 556	19,6	23 602
				01.04-05.05		479 297	280 / 24		494 048	18,3	23 917
2.8 D Turbo	2,8	90		04.00-04.02		478 842	300 / 24	GIR	424 556	19,6	23 602
				05.02-05.05		478 842	300 / 24	BRB	424 769	19,1	23 919
2.8 D Turbo Interc.	2,8	103,3		10.00-04.02		478 842	300 / 24	GIR	424 556	19,6	23 602
				05.02-05.05				BRB	424 769	19,1	23 919
2.8 JTD	2,8	93		06.05→		479 297	280 / 24		494 048	18,3	23 917
Ducato Maxi 17 [251..]	2,3	88/96		06.06→		479 314	300 / 24	BRB	494 109	19	24 466
3.0 JTD	3,0	116		06.06→		479 314	300 / 24	BRB	494 109	19	24 466
Ducato Maxi 20 [251..]	2,3	88/96		06.06→		479 315	300 / 32	BRB	494 109	19	24 466
3.0 JTD	3,0	116		06.06→		479 315	300 / 32	BRB	494 109	19	24 466
Ducato 10 [230..]	1,9	50	Fg.no. →5788441	04.98-10.01		478 843	279,5 / 18	GIR	424 030	19,5	21 797
1.9 D			Fg.no. 5788442→	04.98-10.01		478 843	279,5 / 18	GIR	424 556	19,6	23 602
		51	Fg.no. →5788441	03.94-03.98		478 843	279,5 / 18	GIR	424 030	19,5	21 797



				0 986...	0 986...	1 987...	1 987...	
◀FIAT								
Ducato 10 [230..]	1,9	51	Fg.no. 5788442→	03.94-03.98	478 843	279,5 / 18	GIR 424 556	19,6 23 602
1.9 D								
1.9 TD	1,9	60	Fg.no. →5788441	03.94-03.98	478 843	279,5 / 18	GIR 424 030	19,5 21 797
			Fg.no. 5788442→	03.94-03.98	478 843	279,5 / 18	GIR 424 556	19,6 23 602
		66	Fg.no. →5788441	04.98-10.01	478 843	279,5 / 18	GIR 424 030	19,5 21 797
			Fg.no. 5788442→	04.98-10.01	478 843	279,5 / 18	GIR 424 556	19,6 23 602
1.9 TD CAT	1,9	59	Fg.no. →5788441	03.94-03.98	478 843	279,5 / 18	GIR 424 030	19,5 21 797
			Fg.no. 5788442→	03.94-03.98	478 843	279,5 / 18	GIR 424 556	19,6 23 602
2.0	2,0	79		03.94-03.02	478 843	279,5 / 18	GIR 424 030	19,5 21 797
2.0 i.e.	2,0	80		03.94-03.02	478 843	279,5 / 18	GIR 424 030	19,5 21 797
2.0 JTD	2,0	63	Fg.no. →5788441	10.01-03.02	478 843	279,5 / 18	GIR 424 030	19,5 21 797
			Fg.no. 5788442→	10.01-03.02	478 843	279,5 / 18	GIR 424 556	19,6 23 602
2.5 D	2,5	62	Fg.no. →5788441	03.94-03.98	478 843	279,5 / 18	GIR 424 030	19,5 21 797
			Fg.no. 5788442→	03.94-03.98	478 843	279,5 / 18	GIR 424 556	19,6 23 602
2.5 TD ECO	2,5	80	Fg.no. →5788441	03.94-03.98	478 843	279,5 / 18	GIR 424 030	19,5 21 797
			Fg.no. 5788442→	03.94-03.98	478 843	279,5 / 18	GIR 424 556	19,6 23 602
2.5 TD EGR	2,5	85	Fg.no. →5788441	03.94-03.98	478 434	280 / 24	GIR 424 030	19,5 21 797
			Fg.no. 5788442→	03.94-03.98	478 434	280 / 24	GIR 424 556	19,6 23 602
2.8 D	2,8	64	Fg.no. →5788441	04.98-03.02			GIR 424 030	19,5 21 797
			Fg.no. 5788442→	04.98-03.02			GIR 424 556	19,6 23 602
			6194400					
			Fg.no. →6194400	04.98-03.02	478 843	279,5 / 18		
			Fg.no. 6194401→	04.98-03.02	479 297	280 / 24	494 048	18,3 23 917
2.8 JTD	2,8	94	Fg.no. →5788441	08.00-03.02	478 434	280 / 24	GIR 424 030	19,5 21 797
			Fg.no. 5788442→	08.00-03.02	478 434	280 / 24	GIR 424 556	19,6 23 602
2.8 JTD EGR	2,8	94	Fg.no. →5788441	08.00-03.02	478 434	280 / 24	GIR 424 030	19,5 21 797
			Fg.no. 5788442→	08.00-03.02	478 434	280 / 24	GIR 424 556	19,6 23 602
2.8 TD	2,8	90	Fg.no. →5788441	10.97-03.02	478 434	280 / 24	GIR 424 030	19,5 21 797
			Fg.no. 5788442→	10.97-03.02	478 434	280 / 24	GIR 424 556	19,6 23 602
2.8 TD EGR	2,8	90	Fg.no. →5788441	10.97-03.02	478 434	280 / 24	GIR 424 030	19,5 21 797
			Fg.no. 5788442→	10.97-03.02	478 434	280 / 24	GIR 424 556	19,6 23 602
[234..] 2.0 i.e.	2,0	80		03.94-03.02	478 843	279,5 / 18	GIR 424 030	19,5 21 797
Bipower CNG 4x4								
2.5 TD EGR 4x4	2,5	85	Fg.no. →5782691	03.94-03.98	478 434	280 / 24	GIR 424 030	19,5 21 797
			Fg.no. 5782692→	03.94-03.98	478 434	280 / 24	GIR 424 556	19,6 23 602
2.5 TD 4x4	2,5	85	Fg.no. →5782691	03.94-03.98	478 434	280 / 24	GIR 424 030	19,5 21 797
			Fg.no. 5782692→	03.94-03.98	478 434	280 / 24	GIR 424 556	19,6 23 602
2.8 JTD EGR 4x4	2,8	94	Fg.no. →5788441	08.00-03.02	478 434	280 / 24	GIR 424 030	19,5 21 797
			Fg.no. 5788442→	08.00-03.02	478 434	280 / 24	GIR 424 556	19,6 23 602
2.8 JTD 4x4	2,8	94	Fg.no. →5788441	08.00-03.02	478 434	280 / 24	GIR 424 030	19,5 21 797
			Fg.no. 5788442→	08.00-03.02	478 434	280 / 24	GIR 424 556	19,6 23 602
2.8 TD EGR 4x4	2,8	90	Fg.no. →5788441	10.97-03.02	478 434	280 / 24	GIR 424 030	19,5 21 797
			Fg.no. 5788442→	10.97-03.02	478 434	280 / 24	GIR 424 556	19,6 23 602
2.8 TD 4x4	2,8	90	Fg.no. →5788441	10.97-03.02	478 434	280 / 24	GIR 424 030	19,5 21 797
			Fg.no. 5788442→	10.97-03.02	478 434	280 / 24	GIR 424 556	19,6 23 602
[279..] 1.9 D	1,9	52		07.90-02.94	478 200	255 / 16	GIR 467 411	19 20 741
1.9 TD	1,9	60		07.90-02.94	478 200	255 / 16	GIR 467 411	19 20 741
2.0	2,0	55/63		07.90-02.94	478 200	255 / 16	GIR 467 411	19 20 741
2.5 TD	2,5	70		07.90-02.94	478 200	255 / 16	GIR 467 411	19 20 741
[280..] 1.8	1,8	49-51	Ricam.no	09.81-05.85	478 067	257 / 12	GIR 467 411	19 20 741
			→VETT.0154462					
			Ricam.no	09.81-05.85	478 200	255 / 16	GIR 467 411	19 20 741
			VETT.0154463→	06.85-06.90	478 200	255 / 16	GIR 467 411	19 20 741
1.9 D	1,9	52		02.87-06.90	478 200	255 / 16	GIR 467 411	19 20 741
1.9 TD	1,9	60		02.87-06.90	478 200	255 / 16	GIR 467 411	19 20 741
2.0	2,0	55	Ricam.no	06.85-12.85	478 067	257 / 12	GIR 467 411	19 20 741
			→VETT.0154462					
			Ricam.no	06.85-12.85	478 200	255 / 16	GIR 467 411	19 20 741
			VETT.0154463→					
		57	Ricam.no	09.81-05.85	478 067	257 / 12	GIR 467 411	19 20 741
			→VETT.0154462					
			Ricam.no	09.81-05.85	478 200	255 / 16	GIR 467 411	19 20 741
			VETT.0154463→					

				0 986...				0 986...			1 987...	1 987...
Ducato 10 [280..]	2.0	2,0	63	06.88-06.90	▮ 478 200	255 / 16	GIR	467 411	19	20 741		
2.5 D	2,5	53	Ricam.no →VETT.0154462	05.81-12.85	▮ 478 067	257 / 12	GIR	467 411	19	20 741		
			Ricam.no VETT.0154463→	05.81-12.85	▮ 478 200	255 / 16	GIR	467 411	19	20 741		
		54-55	Ricam.no →VETT.0154462	05.81-12.85	▮ 478 067	257 / 12	GIR	467 411	19	20 741		
			Ricam.no	05.81-12.85	▮ 478 200	255 / 16	GIR	467 411	19	20 741		
			VETT.0154463→	01.86-06.90	▮ 478 200	255 / 16	GIR	467 411	19	20 741		
Ducato 11 [243..]	2.0	81		04.02-08.06	▮ 478 434	280 / 24		494 048	18,3	23 917		
2.0 i.e.												
2.0 JTD	2,0	62		04.02-08.06	▮ 478 434	280 / 24		494 048	18,3	23 917		
2.3 JTD	2,3	81		04.02-08.06	▮ 478 434	280 / 24		494 048	18,3	23 917		
				01.08→	▮ 479 297	280 / 24		494 048	18,3	23 917		
2.3 JTD EGR	2,3	81		04.02-08.06	▮ 478 434	280 / 24		494 048	18,3	23 917		
2.8 JTD	2,8	94		04.02-08.06	▮ 478 434	280 / 24		494 048	18,3	23 917		
2.8 JTD EGR	2,8	94		04.02-08.06	▮ 478 434	280 / 24		494 048	18,3	23 917		
2.8 TD	2,8	90		10.02-08.06	▮ 478 434	280 / 24		494 048	18,3	23 917		
2.8 TD EGR	2,8	90		10.02-08.06	▮ 478 434	280 / 24		494 048	18,3	23 917		
[247..] 2.0 i.e. 4x4	2,0	81		04.02-08.06	▮ 478 434	280 / 24		494 048	18,3	23 917		
2.8 JTD EGR 4x4	2,8	94		04.02-08.06	▮ 478 434	280 / 24		494 048	18,3	23 917		
2.8 JTD 4x4	2,8	94		04.02-08.06	▮ 478 434	280 / 24		494 048	18,3	23 917		
2.8 TD EGR 4x4	2,8	90		10.02-08.06	▮ 478 434	280 / 24		494 048	18,3	23 917		
[250..] 2.2 JTD	2,2	74		06.06→	▮ 479 297	280 / 24	BRB	494 111	19,1	24 468		
2.3 JTD	2,3	88/96		06.06→	▮ 479 297	280 / 24	BRB	494 111	19,1	24 468		
3.0 JTD	3,0	116		06.06→	▮ 479 297	280 / 24	BRB	494 111	19,1	24 468		
Ducato 12 [284..]	2.0	63		07.90-02.94	▮ 478 200	255 / 16	GIR	467 411	19	20 741		
2.0 4x4												
2.5 D 4x4	2,5	55		07.90-02.94	▮ 478 200	255 / 16	GIR	467 411	19	20 741		
2.5 TD 4x4	2,5	70		07.90-02.94	▮ 478 234	290 / 16	GIR	460 998	19,5	21 205		
Ducato 13 [280..]	2.0	2,0	55	06.85-12.85	▮ 478 067	257 / 12	GIR	467 411	19	20 741		
			Ricam.no →VETT.0154462									
			Ricam.no VETT.0154463→	06.85-12.85	▮ 478 200	255 / 16	GIR	467 411	19	20 741		
		57	Ricam.no →VETT.0154462	09.81-05.85	▮ 478 067	257 / 12	GIR	467 411	19	20 741		
			Ricam.no VETT.0154463→	09.81-05.85	▮ 478 200	255 / 16	GIR	467 411	19	20 741		
2.5 D	2,5	53	Ricam.no →VETT.0154462	05.81-12.85	▮ 478 067	257 / 12	GIR	467 411	19	20 741		
			Ricam.no VETT.0154463→	05.81-12.85	▮ 478 200	255 / 16	GIR	467 411	19	20 741		
Ducato 14 [231..]	1.9	60	Fg.no. →5782691	03.94-03.98	▮ 478 843	279,5 / 18	GIR	424 030	19,5	21 797		
1.9 TD			Fg.no. 5782692→	03.94-03.98	▮ 478 843	279,5 / 18	GIR	424 556	19,6	23 602		
		66	Fg.no. →5782691	04.98-10.01	▮ 478 843	279,5 / 18	GIR	424 030	19,5	21 797		
			Fg.no. 5782692→	04.98-10.01	▮ 478 843	279,5 / 18	GIR	424 556	19,6	23 602		
1.9 TD CAT	1,9	59	Fg.no. →5782691	03.94-03.98	▮ 478 843	279,5 / 18	GIR	424 030	19,5	21 797		
			Fg.no. 5782692→	03.94-03.98	▮ 478 843	279,5 / 18	GIR	424 556	19,6	23 602		
2.0	2,0	79		03.94-03.02	▮ 478 843	279,5 / 18	GIR	424 030	19,5	21 797		
2.0 i.e.	2,0	80		03.94-03.02	▮ 478 843	279,5 / 18	GIR	424 030	19,5	21 797		
2.0 JTD	2,0	63	Fg.no. →5788441	10.01-03.02			GIR	424 030	19,5	21 797		
			Fg.no. 5788442→	10.01-03.02			GIR	424 556	19,6	23 602		
			6194400									
			Fg.no. →6194400	10.01-03.02	▮ 478 843	279,5 / 18						
			Fg.no. 6194401→	10.01-03.02	▮ 479 297	280 / 24		494 048	18,3	23 917		
2.5 D	2,5	62	Fg.no. →5782691	03.94-03.98	▮ 478 843	279,5 / 18	GIR	424 030	19,5	21 797		
			Fg.no. 5782692→	03.94-03.98	▮ 478 843	279,5 / 18	GIR	424 556	19,6	23 602		
2.5 TD	2,5	85	Fg.no. →5788441	03.94-03.98	▮ 478 434	280 / 24	GIR	424 030	19,5	21 797		
			Fg.no. 5788442→	03.94-03.98	▮ 478 434	280 / 24	GIR	424 556	19,6	23 602		
2.5 TDECO	2,5	80	Fg.no. →5788441	03.94-03.98	▮ 478 434	280 / 24	GIR	424 030	19,5	21 797		
			Fg.no. 5788442→	03.94-03.98	▮ 478 434	280 / 24	GIR	424 556	19,6	23 602		
2.5 TDEGR	2,5	85	Fg.no. →5788441	03.94-03.98	▮ 478 434	280 / 24	GIR	424 030	19,5	21 797		



				0 986...	0 986...	1 987...	1 987...		
◀ FIAT									
Ducato 14 [231..]	2,5	85	Fg.no. 5788442→	03.94-03.98	478 434	280 / 24	GIR 424 556	19,6	23 602
2.5 TD EGR									
2.8 D	2,8	64	Fg.no. →5782691	04.98-03.02			GIR 424 030	19,5	21 797
			Fg.no. 5788442→	04.98-03.02			GIR 424 556	19,6	23 602
6194400									
			Fg.no. →6194400	04.98-03.02	478 843	279,5 / 18			
			Fg.no. 6194401→	04.98-03.02	479 297	280 / 24			
2.8 JTD	2,8	94		08.00-03.02	478 434	280 / 24			
			Fg.no. 5788442→	08.00-03.02			GIR 424 556	19,6	23 602
2.8 JTD EGR	2,8	94		08.00-03.02	478 434	280 / 24			
			Fg.no. 5788442→	08.00-03.02			GIR 424 556	19,6	23 602
2.8 TD	2,8	90	Fg.no. →5788441	10.97-03.02	478 434	280 / 24	GIR 424 030	19,5	21 797
			Fg.no. 5788442→	10.97-03.02	478 434	280 / 24	GIR 424 556	19,6	23 602
2.8 TD EGR	2,8	90	Fg.no. →5788441	10.97-03.02	478 434	280 / 24	GIR 424 030	19,5	21 797
			Fg.no. 5788442→	10.97-03.02	478 434	280 / 24	GIR 424 556	19,6	23 602
[234..] 2.0 i.e.	2,0	80		03.94-03.02	478 843	279,5 / 18	GIR 424 030	19,5	21 797
Bipower CNG 4x4									
2.5 TD ECO 4x4	2,5	80	Fg.no. →5788441	03.94-03.98	478 434	280 / 24	GIR 424 030	19,5	21 797
			Fg.no. 5788442→	03.94-03.98	478 434	280 / 24	GIR 424 556	19,6	23 602
2.5 TD EGR 4x4	2,5	85	Fg.no. →5788441	03.94-03.98	478 434	280 / 24	GIR 424 030	19,5	21 797
			Fg.no. 5788442→	03.94-03.98	478 434	280 / 24	GIR 424 556	19,6	23 602
2.8 JTD EGR 4x4	2,8	94	Fg.no. →5788441	08.00-03.02	478 434	280 / 24	GIR 424 030	19,5	21 797
			Fg.no. 5788442→	08.00-03.02	478 434	280 / 24	GIR 424 556	19,6	23 602
2.8 JTD 4x4	2,8	94	Fg.no. →5788441	08.00-03.02	478 434	280 / 24	GIR 424 030	19,5	21 797
			Fg.no. 5788442→	08.00-03.02	478 434	280 / 24	GIR 424 556	19,6	23 602
2.8 TD EGR 4x4	2,8	90	Fg.no. →5788441	10.97-03.02	478 434	280 / 24	GIR 424 030	19,5	21 797
			Fg.no. 5788442→	10.97-03.02	478 434	280 / 24	GIR 424 556	19,6	23 602
2.8 TD 4x4	2,8	90	Fg.no. →5788441	10.97-03.02	478 434	280 / 24	GIR 424 030	19,5	21 797
			Fg.no. 5788442→	10.97-03.02	478 434	280 / 24	GIR 424 556	19,6	23 602
[280..] 1.9 TD	1,9	60		02.87-02.94	478 200	255 / 16	GIR 467 411	19	20 741
2.0	2,0	55/63		01.86-02.94	478 200	255 / 16	GIR 467 411	19	20 741
2.5 D	2,5	55		01.86-02.94	478 200	255 / 16	GIR 467 411	19	20 741
2.5 D 4x4	2,5	55		01.89-06.90	478 200	255 / 16	GIR 467 411	19	20 741
2.5 TD	2,5	68/70		01.86-02.94	478 200	255 / 16	GIR 467 411	19	20 741
2.5 TD 4x4	2,5	68		01.89-06.90	478 234	290 / 16	GIR 467 411	19	20 741
Ducato 15 [244..]	2,0	81		04.02-08.06	478 434	280 / 24	494 048	18,3	23 917
2.0 i.e.									
2.0 i.e. Bipower CNG	2,0	71-81		04.02-08.06	478 434	280 / 24	494 048	18,3	23 917
2.0 JTD	2,0	62		04.02-08.06	478 434	280 / 24	494 048	18,3	23 917
2.3 JTD	2,3	81		04.02-08.06	478 434	280 / 24	494 048	18,3	23 917
				01.08→	479 297	280 / 24	494 048	18,3	23 917
2.3 JTD EGR	2,3	81		04.02-08.06	478 434	280 / 24	494 048	18,3	23 917
				01.08→	479 297	280 / 24	494 048	18,3	23 917
2.8 JTD	2,8	94		04.02-08.06	478 434	280 / 24	494 048	18,3	23 917
2.8 JTD CGV	2,8	107		04.04-08.06	478 434	280 / 24	494 048	18,3	23 917
2.8 JTD EGR	2,8	94		04.02-08.06	478 434	280 / 24	494 048	18,3	23 917
2.8 TD	2,8	90		10.02-08.06	478 434	280 / 24	494 048	18,3	23 917
2.8 TD EGR	2,8	90		10.02-08.06	478 434	280 / 24	494 048	18,3	23 917
[247..] 2.0 i.e.	2,0	71-81		04.02-08.06	478 434	280 / 24	494 048	18,3	23 917
Bipower CNG 4x4									
2.0 i.e. 4x4	2,0	81		04.02-08.06	478 434	280 / 24	494 048	18,3	23 917
2.8 JTD EGR 4x4	2,8	94		04.02-08.06	478 434	280 / 24	494 048	18,3	23 917
2.8 JTD 4x4	2,8	94		04.02-08.06	478 434	280 / 24	494 048	18,3	23 917
2.8 TD EGR 4x4	2,8	90		10.02-08.06	478 434	280 / 24	494 048	18,3	23 917
2.8 TD 4x4	2,8	90		10.02-08.06	478 434	280 / 24	494 048	18,3	23 917
[250..] 2.2 JTD	2,2	74		06.06→	479 297	280 / 24	BRB 494 111	19,1	24 468
2.3 JTD	2,3	88/96		06.06→	479 297	280 / 24	BRB 494 111	19,1	24 468
3.0 JTD	3,0	116		06.06→	479 297	280 / 24	BRB 494 111	19,1	24 468
Ducato 17 [250..]	2,2	74		06.06→	479 313	280 / 28	BRB 494 111	19,1	24 468
2.2 JTD									
2.3 JTD	2,3	88/96		06.06→	479 313	280 / 28	BRB 494 111	19,1	24 468
3.0 JTD	3,0	116		06.06→	479 313	280 / 28	BRB 494 111	19,1	24 468

				0 986...		0 986...		1 987...		1 987...	
Ducato 18 [232..]	2,0	80		03.94-03.02	478 842	300 / 24	GIR	424 031	19,6	21 800	
2.0 i.e. Bipower CNG											
2.5 D	2,5	62	Fg.no. →5788441	03.94-03.98	478 842	300 / 24	GIR	424 031	19,6	21 800	
			Fg.no. 5788442→	03.94-03.98	478 842	300 / 24	GIR	424 556	19,6	23 602	
2.5 TD	2,5	85	Fg.no. →5788441	03.94-03.98	478 842	300 / 24	GIR	424 031	19,6	21 800	
			Fg.no. 5788442→	03.94-03.98	478 842	300 / 24	GIR	424 556	19,6	23 602	
2.5 TD ECO	2,5	80	Fg.no. →5788441	03.94-03.98	478 842	300 / 24	GIR	424 031	19,6	21 800	
			Fg.no. 5788442→	03.94-03.98	478 842	300 / 24	GIR	424 556	19,6	23 602	
2.8 D	2,8	64	Fg.no. →5788441	03.94-03.98	478 842	300 / 24	GIR	424 031	19,6	21 800	
			Fg.no. 5788442→	03.94-03.98	478 842	300 / 24	GIR	424 556	19,6	23 602	
2.8 JTD	2,8	94		08.00-03.02	478 842	300 / 24					
			Fg.no. 5788442→	08.00-03.02			GIR	424 556	19,6	23 602	
2.8 JTD EGR	2,8	94		08.00-03.02	478 842	300 / 24					
			Fg.no. 5788442→	08.00-03.02			GIR	424 556	19,6	23 602	
2.8 TD	2,8	90	Fg.no. →5788441	10.97-03.02	478 842	300 / 24	GIR	424 031	19,6	21 800	
			Fg.no. 5788442→	10.97-03.02	478 842	300 / 24	GIR	424 556	19,6	23 602	
2.8 TD EGR	2,8	90	Fg.no. →5788441	10.97-03.02	478 842	300 / 24	GIR	424 031	19,6	21 800	
			Fg.no. 5788442→	10.97-03.02	478 842	300 / 24	GIR	424 556	19,6	23 602	
[234..] 2.5 D 4x4	2,5	62		03.94-03.98	478 842	300 / 24	GIR	424 031	19,6	21 800	
TD 4x4	2,5	85		03.94-03.98	478 842	300 / 24	GIR	424 031	19,6	21 800	
2.8 D 4x4	2,8	64		04.98-03.02	478 842	300 / 24	GIR	424 031	19,6	21 800	
2.8 JTD EGR 4x4	2,8	94		08.00-03.02	478 842	300 / 24	GIR	424 031	19,6	21 800	
2.8 JTD 4x4	2,8	94		08.00-03.02	478 842	300 / 24	GIR	424 031	19,6	21 800	
2.8 TD EGR 4x4	2,8	90		10.97-03.02	478 842	300 / 24	GIR	424 031	19,6	21 800	
2.8 TD 4x4	2,8	90		10.97-03.02	478 842	300 / 24	GIR	424 031	19,6	21 800	
[245..] 2.0 i.e.	2,0	81		04.02-08.06	478 842	300 / 24	BRB	424 769	19,1	23 919	
2.0 i.e. Bipower CNG	2,0	71-81		04.02-08.06	478 842	300 / 24	BRB	424 769	19,1	23 919	
2.3 JTD	2,3	81		04.02-08.06	478 842	300 / 24	BRB	424 769	19,1	23 919	
				01.08→	478 842	300 / 24	BRB	424 769	19,1	23 919	
2.3 JTD EGR	2,3	81		01.08→	478 842	300 / 24	BRB	424 769	19,1	23 919	
2.8 JTD	2,8	94		04.02-08.06	478 842	300 / 24	BRB	424 769	19,1	23 919	
2.8 JTD CGV	2,8	107		04.04-08.06	478 842	300 / 24	BRB	424 769	19,1	23 919	
2.8 JTD EGR	2,8	94		04.02-08.06	478 842	300 / 24	BRB	424 769	19,1	23 919	
2.8 TD	2,8	90		10.02-08.06	478 842	300 / 24	BRB	424 769	19,1	23 919	
[247..] 2.0 i.e.	2,0	71-81		04.02-08.06	478 842	300 / 24	BRB	424 769	19,1	23 919	
Bipower CNG 4x4											
2.0 i.e. 4x4	2,0	81		04.02-08.06	478 842	300 / 24	BRB	424 769	19,1	23 919	
2.8 JTD EGR 4x4	2,8	94		04.02-08.06	478 842	300 / 24	BRB	424 769	19,1	23 919	
2.8 JTD 4x4	2,8	94		04.02-08.06	478 842	300 / 24	BRB	424 769	19,1	23 919	
2.8 TD 4x4	2,8	90		10.02-08.06	478 842	300 / 24	BRB	424 769	19,1	23 919	
[280..] 2.0	2,0	63		06.88-06.90	478 234	290 / 16	GIR	467 411	19	20 741	
2.0 Maxi	2,0	63		06.86-06.90	478 234	290 / 16	GIR	460 998	19,5	21 205	
2.5 D Maxi	2,5	55		01.86-06.90	478 200	255 / 16	GIR	467 411	19	20 741	
2.5 TD Maxi	2,5	68		01.86-06.90	478 234	290 / 16	GIR	467 411	19	20 741	
[282..] 2.0 Maxi	2,0	63		07.90-02.94	478 234	290 / 16	GIR	460 998	19,5	21 205	
2.5 D Maxi	2,5	55		07.90-02.94	478 200	255 / 16	GIR	467 411	19	20 741	
2.5 TD Maxi	2,5	70		07.90-02.94	478 234	290 / 16	GIR	460 998	19,5	21 205	
Fiorino [127..] 1.3 D	1,3	33		04.82-12.87	478 063	227 / 10,8					474 099
							ATE	424 047		20 375	
							BSY	460 736	17,3	20 073	
1050	1,0	37		01.80-12.87	478 063	227 / 10,8					474 099
							ATE	424 047		20 375	
							BSY	460 736	17,3	20 073	
[225..] 1.3 MJTD	1,3	55		12.07→	478 639	257,5 / 22					
			Fg.no. →6446	12.07→			BSY	494 113	18	23 982	
1.4 i.e.	1,4	55		12.07→	478 639	257,5 / 22					
			Fg.no. →6446	12.07→			BSY	494 113	18	23 982	
[255..] 1.1	1,1	40		01.88-08.93	478 353	240,5 / 12	ATE	460 986	18	21 193	
1.3	1,3	49		01.88-12.01	478 353	240,5 / 12	ATE	460 986	18	21 193	
1.3 D	1,3	33		01.88-08.93	478 353	240,5 / 12	ATE	460 986	18	21 193	
1.4 i.e.	1,4	49		06.95-12.01	478 353	240,5 / 12	ATE	424 458	18	21 962	
		52		09.93-06.95	478 353	240,5 / 12	ATE	424 458	18	21 962	
1.5 i.e.	1,5	55		01.88-08.93	478 353	240,5 / 12	ATE	460 986	18	21 193	



				0 986...	0 986...	1 987...	1 987...	
◀ FIAT								
Fiorino [255..]	1.6 i.e.	1,6	59	09.93-12.01	▮ 478 353	240,5 / 12	ATE 424 458	18 21 962
	1.7 D	1,7	42	01.88-08.93	▮ 478 353	240,5 / 12	ATE 460 986	18 21 193
			43	01.88-12.01	▮ 478 353	240,5 / 12	ATE 460 986	18 21 193
	1.7 TDS	1,7	46	02.97-12.01	▮ 478 353	240,5 / 12	ATE 424 458	18 21 962
Fiorino Qubo [300..]		1,3	55	09.08→	▮ 478 639	257,5 / 22		
	1.3 MJTD			Fg.no. →6446	09.08→	GS	BSY 494 113	18 23982
	1.4 i.e.	1,4	55	09.08→	▮ 478 639	257,5 / 22		
				Fg.no. →6446	09.08→		BSY 494 113	18 23982
Panda Van [241..]		1,0	33	10.87-05.91	▮ 478 063	227 / 10,8		
	1000 ACT					OVA	BSY 424 098	18 20 775
Scudo [222..]	1.6 i	1,6	58	10.95-05.00	▮ 478 896	257,5 / 20	BSY 424 415	18,5 23 042
					▮ 478 812	280,6 / 26	GIR, 424 033	19,3 21 801
							LUC	
	1.9 D	1,9	51	10.95-08.01	▮ 478 896	257,5 / 20	BSY 424 415	18,5 23 042
					▮ 478 812	280,6 / 26	GIR, 424 033	19,3 21 801
							LUC	
				06.04-01.07	▮ 478 896	257,5 / 20	BSY 424 415	18,5 23 042
					▮ 478 812	280,6 / 26	GIR 424 789	19,3 20 261
					▮ 479 114	285 / 28		
			52	09.01-05.04	▮ 478 896	257,5 / 20	BSY 424 415	18,5 23 042
					▮ 478 812	280,6 / 26	GIR, 424 033	19,3 21 801
							LUC	
	1.9 TD	1,9	66	03.97-05.00	▮ 478 896	257,5 / 20	BSY 424 415	18,5 23 042
					▮ 478 812	280,6 / 26	GIR, 424 033	19,3 21 801
							LUC	
			68	10.95-05.00	▮ 478 896	257,5 / 20	BSY 424 415	18,5 23 042
					▮ 478 812	280,6 / 26	GIR, 424 033	19,3 21 801
							LUC	
	2.0 8V JTD	2,0	70	10.99-05.04	▮ 478 896	257,5 / 20	BSY 424 415	18,5 23 042
					▮ 478 812	280,6 / 26	GIR, 424 033	19,3 21 801
							LUC	
				06.04-01.07	▮ 478 896	257,5 / 20	BSY 424 415	18,5 23 042
					▮ 479 114	285 / 28	GIR 424 789	19,3 20 261
			81	10.99-05.04	▮ 478 896	257,5 / 20	BSY 424 415	18,5 23 042
					▮ 478 812	280,6 / 26	GIR, 424 033	19,3 21 801
							LUC	
				06.04-01.07	▮ 478 896	257,5 / 20	BSY 424 415	18,5 23 042
					▮ 479 114	285 / 28	GIR 424 789	19,3 20 261
	2.0 16V	2,0	100	05.00-05.04	▮ 478 896	257,5 / 20	BSY 424 415	18,5 23 042
					▮ 478 812	280,6 / 26	GIR, 424 033	19,3 21 801
							LUC	
				06.04-01.07	▮ 478 896	257,5 / 20	BSY 424 415	18,5 23 042
					▮ 479 114	285 / 28	GIR 424 789	19,3 20 261
	2.0 16V JTD	2,0	81	09.00-05.04	▮ 478 896	257,5 / 20	BSY 424 415	18,5 23 042
					▮ 478 812	280,6 / 26	GIR, 424 033	19,3 21 801
							LUC	
				06.04-01.07	▮ 478 896	257,5 / 20	BSY 424 415	18,5 23 042
					▮ 479 114	285 / 28	GIR 424 789	19,3 20 261
	[272..]	1.6 D Multijet	1,6 66	01.07→	4SB	▮ 479 380	304 / 28	
		2.0 D Multijet	2,0 88/103	01.07→		▮ 479 380	304 / 28	
Strada [278]		1,2	44	03.99-03.03	▮ 478 515	257,3 / 20	ATE 424 554	18 23 552
	1.2 MPI 8V		54	05.01→	▮ 478 515	257,3 / 20	ATE 424 554	18 23 552
	1.3 JTD	1,3	63	07.05→	▮ 478 515	257,3 / 20	ATE 424 554	18 23 552
	1.7 TDS	1,7	51	03.99-03.03	▮ 478 515	257,3 / 20	ATE 424 554	18 23 552
	1.9 D	1,9	46	11.00-06.05	▮ 478 515	257,3 / 20	ATE 424 554	18 23 552
	1.9 JTD	1,9	59	04.03-06.05	▮ 478 515	257,3 / 20	ATE 424 554	18 23 552
Strada Adventure		1,7	52	10.06-12.08	▮ 478 515	257,3 / 20		
	1.7 TD							
Talento	1.9 D	1,9	51	03.88-12.94	▮ 478 200	255 / 16	GIR 467 411	19 20 741
	2.0	2,0	55	07.90-12.94	▮ 478 200	255 / 16	GIR 467 411	19 20 741
Uno Van [246..]	1.0 9	0,9	33	09.89-03.94	▮ 478 063	227 / 10,8	BSY 424 098	18 20 775 474 106
	1.0	1,0	33	04.92-09.92	▮ 478 063	227 / 10,8	BSY 424 098	18 20 775 474 106
	1.0 i.e.	1,0	33	09.89-03.94	▮ 478 063	227 / 10,8	BSY 424 098	18 20 775 474 106



F



						0 986...		0 986...			1 987...	1 987...
Uno Van [246..] 1.7 D	1,7	42		01.91-03.94		478 353	240,5 / 12	GIR	468 380	17	20 838	
238 E	1,4	38		06.80-12.81					487 421			
900 E Furgone	0,9	33	Fg.no. Vett.414672→	05.81-12.87 OVA				BSY	424 098	18	20 775	

FORD

Econovan 1.4	1,4	48		08.85-12.99				AKE	460 020	15	20 002	
2.0 D	2,0	41		02.86-12.99				AKE	460 020	15	20 002	
P 100 1.6 L	1,6	54		04.82-09.87		478 828	239,5 / 24,1	ATE	466 402	18	20 640	
1.8 L TD	1,8	55		02.89-12.92		478 828	239,5 / 24,1	ATE	466 402	18	20 640	
2.0 L	2,0	57		01.88-12.92		478 828	239,5 / 24,1	ATE	466 402	18	20 640	
Ranger 2.5 D	2,5	105		03.06→	NOR			KEL	424 720	16,5	23 540	
[TK6] 2.5 D	2,5	57		01.99→	WW			KEL	424 720	16,5	23 540	
2.5 D 4x4	2,5	57		01.99→	WW			KEL	424 720	16,5	23 540	
2.5 TD	2,5	62		04.02→	WW			KEL	424 720	16,5	23 540	
		80		01.99→	WW			KEL	424 720	16,5	23 540	
2.5 TD 4x4	2,5	62		04.02→	WW			KEL	424 720	16,5	23 540	
		80		01.99→	WW			KEL	424 720	16,5	23 540	
Transit [T_]	1,6	46		01.86-07.91		478 345	254 / 14,3	BSY	491 410	18	21 141	
1.6 80-120												
1.6 100 L	1,6	46		01.86-07.91	BSV	478 190	270 / 14,3	DEP	467 590	18	20 759	474 112
					ZWZ	478 190	270 / 14,3	DEP	463 641	15	20 364	474 115
1.6 130-190	1,6	46		01.86-07.91	BSV	478 190	270 / 14,3	DEP	467 590	18	20 759	474 112
					ZWZ	478 190	270 / 14,3	DEP	463 641	15	20 364	474 115
2.0 80-120	2,0	55-57		10.88-07.91		478 345	254 / 14,3	BSY	491 410	18	21 141	
2.0 100 L	2,0	55-57		10.88-07.91	BSV	478 190	270 / 14,3	DEP	467 590	18	20 759	474 112
					ZWZ	478 190	270 / 14,3	DEP	463 641	15	20 364	474 115
2.0 130-190	2,0	55-57		10.88-07.91	BSV	478 190	270 / 14,3	DEP	467 590	18	20 759	474 112
					ZWZ	478 190	270 / 14,3	DEP	463 641	15	20 364	474 115
2.5 D 80-120	2,5	50-52		01.86-07.91		478 345	254 / 14,3	BSY	491 410	18	21 141	
2.5 D 100 L	2,5	50-52		10.88-07.91	BSV	478 190	270 / 14,3	DEP	467 590	18	20 759	474 112
					ZWZ	478 190	270 / 14,3	DEP	463 641	15	20 364	474 115
2.5 D 130-190	2,5	50-52		10.88-07.91	BSV	478 190	270 / 14,3	DEP	467 590	18	20 759	474 112
					ZWZ	478 190	270 / 14,3	DEP	463 641	15	20 364	474 115
3.0 V6	3,0	78		01.86-07.91	BSV			DEP	467 590	18	20 759	474 112
					ZWZ			DEP	463 641	15	20 364	474 115
[E_] FT 080 2.0i	2,0	66/72		08.91-07.94	VEA			BSY	424 492	18	21 469	
					14Z,MOT	478 160	254 / 24,5	BSY	460 963	18	21 470	
					15Z,MOT	478 166	270 / 24,1	BSY	460 962	18	21 469	
		84		08.94-07.00	5LO	478 160	254 / 24,5	BSY	460 963	18	21 470	
					6LO	478 166	270 / 24,1	BSY	424 492	18	21 469	
					6LO,WW			BSY	460 962	18	21 469	
FT 080 2.5 DI;	2,5	51/52/		08.91-07.94	VEA			BSY	424 492	18	21 469	
DI Turbo		59/63/			14Z,MOT	478 160	254 / 24,5	BSY	460 963	18	21 470	
		74			15Z,MOT	478 166	270 / 24,1	BSY	460 962	18	21 469	
FT 080 2.5 D; DI;	2,5	51/55/		08.94-08.00	5LO	478 160	254 / 24,5	BSY	460 963	18	21 470	
TD; TDI		56/63/			6LO	478 166	270 / 24,1	BSY	424 492	18	21 469	
		74/85			6LO,WW			BSY	460 962	18	21 469	
FT 100 2.0i	2,0	66/72		08.91-07.94	VEA			BSY	424 492	18	21 469	
					14Z,MOT	478 160	254 / 24,5	BSY	460 963	18	21 470	
					15Z,MOT	478 166	270 / 24,1	BSY	460 962	18	21 469	
		84		08.94-07.00	5LO	478 160	254 / 24,5	BSY	460 963	18	21 470	
					6LO	478 166	270 / 24,1	BSY	424 492	18	21 469	
					6LO,WW			BSY	460 962	18	21 469	
FT 100 2.5 DI;	2,5	51/52/		08.91-07.94	VEA			BSY	424 492	18	21 469	
DI Turbo		59/63/			14Z,MOT	478 160	254 / 24,5	BSY	460 963	18	21 470	
		74			15Z,MOT	478 166	270 / 24,1	BSY	460 962	18	21 469	



				0 986...	0 986...	1 987...	1 987...	
◀ FORD								
Transit [E_]	2,5	51/55/	08.94-08.00	5LO	478 160	254 / 24,5	BSY 460 963	18 21 470
FT 100 2.5 D;		56/63/		6LO	478 166	270 / 24,1	BSY 424 492	18 21 469
DI;TD; TDI		74/85		6LO,WW			BSY 460 962	18 21 469
FT 100 2.9iV6	2,9	104	08.91-07.94	VEA			BSY 424 492	18 21 469
				14Z,MOT	478 160	254 / 24,5	BSY 460 963	18 21 470
				15Z,MOT	478 166	270 / 24,1	BSY 460 962	18 21 469
FT 120 2.0i	2,0	66/72	08.91-07.94	VEA			BSY 424 492	18 21 469
				14Z,MOT	478 160	254 / 24,5	BSY 460 963	18 21 470
				15Z,MOT	478 166	270 / 24,1	BSY 460 962	18 21 469
	84		08.94-07.00	5LO	478 160	254 / 24,5	BSY 460 963	18 21 470
				6LO	478 166	270 / 24,1	BSY 424 492	18
				6LO,WW			BSY 460 962	18 21 469
FT 120 2.5 DI;	2,5	51/52/	08.91-07.94	VEA			BSY 424 492	18 21 469
DI Turbo		59/63/		14Z,MOT	478 160	254 / 24,5	BSY 460 963	18 21 470
		74		15Z,MOT	478 166	270 / 24,1	BSY 460 962	18 21 469
FT 120 2.5 D; DI;	2,5	51/55/	08.94-08.00	5LO	478 160	254 / 24,5	BSY 460 963	18 21 469
TD; TDI		56/63/		6LO	478 166	270 / 24,1	BSY 424 492	18
		74/85		6LO,WW			BSY 460 962	18 21 470
FT 120 2.9iV6	2,9	104	08.91-07.94	VEA			BSY 424 492	18 21 469
				14Z,MOT	478 160	254 / 24,5	BSY 460 963	18 21 470
				15Z,MOT	478 166	270 / 24,1	BSY 460 962	18 21 469
FT 150 2.0i	2,0	66/72	08.91-07.94	VEA			BSY 424 492	18 21 469
				14Z,MOT	478 160	254 / 24,5	BSY 460 963	18 21 470
				15Z,MOT	478 166	270 / 24,1	BSY 460 962	18 21 469
	84		08.94-07.00	5LO	478 160	254 / 24,5	BSY 460 963	18 21 470
				6LO	478 166	270 / 24,1	BSY 424 492	18
				6LO,WW			BSY 460 962	18 21 469
FT 150 2.5 DI;	2,5	51/52/	08.91-07.94	VEA			BSY 424 492	18 21 469
DI Turbo		59/63/		14Z,MOT	478 160	254 / 24,5	BSY 460 963	18 21 470
		74		15Z,MOT	478 166	270 / 24,1	BSY 460 962	18 21 469
FT 150 2.5 D; DI;	2,5	51/55/	08.94-08.00	5LO	478 160	254 / 24,5	BSY 460 963	18 21 469
TD; TDI		56/63/		6LO	478 166	270 / 24,1	BSY 424 492	18
		74/85		6LO,WW			BSY 460 962	18 21 470
FT 150 2.9iV6	2,9	104	08.91-07.94	VEA			BSY 424 492	18 21 469
				14Z,MOT	478 160	254 / 24,5	BSY 460 963	18 21 470
				15Z,MOT	478 166	270 / 24,1	BSY 460 962	18 21 469
FT 190 2.0i	2,0	66/72	08.91-07.94	VEA			BSY 424 492	18 21 469
				14Z,MOT	478 160	254 / 24,5	BSY 460 963	18 21 470
				15Z,MOT	478 166	270 / 24,1	BSY 460 962	18 21 469
	2,0	84	08.94-07.00	5LO	478 160	254 / 24,5	BSY 460 963	18 21 470
				6LO	478 166	270 / 24,1	BSY 424 492	18
				6LO,WW			BSY 460 962	18 21 469
FT 190 2.5 DI;	2,5	51/52/	08.91-07.94	VEA			BSY 424 492	18 21 469
DI Turbo		59/63/		14Z,MOT	478 160	254 / 24,5	BSY 460 963	18 21 470
		74		15Z,MOT	478 166	270 / 24,1	BSY 460 962	18 21 469
FT 190 2.5 DI;	2,5	56/74/	08.94-08.00	5LO	478 160	254 / 24,5	BSY 460 963	18 21 470
TD; TDI		85		6LO	478 166	270 / 24,1	BSY 424 492	18
				6LO,WW			BSY 460 962	18 21 469
FT 190 2.9iV6	2,9	104	08.91-07.94	VEA			BSY 424 492	18 21 469
				14Z,MOT	478 160	254 / 24,5	BSY 460 963	18 21 470
				15Z,MOT	478 166	270 / 24,1	BSY 460 962	18 21 469
[F_] FT 240 .. 2.0 TD	2,0	55	08.00-07.06		478 299	276 / 24,5	494 037	17,8 23840
2.0 TDE	2,0	63	08.00-07.06		478 299	276 / 24,5	494 037	17,8 23840
FT 260 .. 2.0 TD	2,0	55	08.00-07.06		478 299	276 / 24,5	494 037	17,8 23840
FT 260 .. 2.0 TDCi	2,0	92	05.02-07.06		478 299	276 / 24,5	494 037	17,8 23840
FT 260 .. 2.0 TDE	2,0	63	08.00-07.06		478 299	276 / 24,5	494 037	17,8 23840
		74	08.00-07.06		478 299	276 / 24,5	494 037	17,8 23840
FT 260 .. 2.2 TDCi	2,2	63/81	04.06→		479 392	280 / 28		
			04.06-01.08				494 170	18,9 24484
		85	10.08→		479 392	280 / 28		
		96/103	04.06→		479 392	280 / 28		
			04.06-01.08				494 170	18,9 24484
FT 260 .. 2.3i	2,3	103-107	08.01-07.06		478 303	294 / 24,5	BSY 494 047	18,5 23 577

				0 986...	0 986...	1 987...	1 987...		
Transit [F_]	2,4	66	04.01-07.06	▮ 478 303	294 / 24,5	BSY	494 047	18,5	23 577
FT 260 .. 2.4 TDE									
FT 280 .. 2.0 TD	2,0	55	08.00-07.06	▮ 478 299	276 / 24,5		494 037	17,8	23840
FT 280 .. 2.0 TDCi	2,0	92	05.02-07.06	▮ 478 299	276 / 24,5		494 037	17,8	23840
FT 280 .. 2.0 TDE	2,0	63/74	08.00-07.06	▮ 478 299	276 / 24,5		494 037	17,8	23840
FT 280 .. 2.2 TDCi	2,2	63/81	04.06→	▮ 479 392	280 / 28				
			04.06-01.08				494 170	18,9	24484
		85	10.08→	▮ 479 392	280 / 28				
		96/103	04.06→	▮ 479 392	280 / 28				
			04.06-01.08				494 170	18,9	24484
FT 280 .. 2.3i	2,3	103-107	08.01-07.06	▮ 478 303	294 / 24,5	BSY	494 047	18,5	23 577
FT 280 .. 2.4 TDE	2,4	55	01.00-09.03	▮ 478 303	294 / 24,5	BSY	494 047	18,5	23 577
		66	01.00-07.06	▮ 478 303	294 / 24,5	BSY	494 047	18,5	23 577
		85	03.04-07.06	▮ 478 303	294 / 24,5	BSY	494 047	18,5	23 577
		92	01.00-07.06	▮ 478 303	294 / 24,5	BSY	494 047	18,5	23 577
FT 280 .. 2.4 TDI	2,4	66	01.01-01.03	▮ 478 303	294 / 24,5				
			01.01-05.06			BSY	494 047	18,5	23 577
FT 300 .. 2.0 TD	2,0	55	08.00-07.06	▮ 478 299	276 / 24,5		494 037	17,8	23840
FT 300 .. 2.0 TDCi	2,0	92	05.02-07.06	▮ 478 299	276 / 24,5		494 037	17,8	23840
FT 300 .. 2.0 TDE	2,0	63/74	08.00-07.06	▮ 478 299	276 / 24,5		494 037	17,8	23840
FT 300 .. 2.2 TDCi	2,2	63/81	04.06→	▮ 479 392	280 / 28				
			04.06-01.08				494 170	18,9	24484
		85	10.08→	▮ 479 392	280 / 28				
		96/103	04.06→	▮ 479 392	280 / 28				
			04.06-01.08				494 170	18,9	24484
FT 300 .. 2.3i	2,3	107	08.00-07.06	▮ 478 303	294 / 24,5	BSY	494 047	18,5	23 577
FT 300 .. 2.4 TDCi	2,4	74	07.06→	▮ 479 307	300 / 28		494 170	18,9	24484
FT 310 S 2.4 TDI	2,4	88	01.01-01.03	▮ 478 303	294 / 24,5				
			01.01-05.06			BSY	494 047	18,5	23 577
FT 330 .. 2.0 TDCi	2,0	92	05.02-07.06	▮ 478 303	294 / 24,5	BSY	494 047	18,5	23 577
FT 330 .. 2.0 TDE	2,0	74	08.03-07.06	▮ 478 303	294 / 24,5	BSY	494 047	18,5	23 577
FT 330 .. 2.2 TDCi	2,2	81	04.06→	▮ 479 307	300 / 28				
			04.06-01.08				494 170	18,9	24484
		85	10.08→	▮ 479 307	300 / 28				
		96/103	04.06→	▮ 479 307	300 / 28				
			04.06-01.08				494 170	18,9	24484
FT 330 .. 2.3i	2,3	103-107	12.00-07.06	▮ 478 303	294 / 24,5	BSY	494 047	18,5	23 577
		100-107	04.06→	▮ 479 307	300 / 28		494 170	18,9	24484
FT 330 .. 2.4 TD	2,4	55	01.00-09.03	▮ 478 303	294 / 24,5	BSY	494 047	18,5	23 577
FT 330 .. 2.4 TDCi	2,4	101	03.04-07.06	▮ 478 303	294 / 24,5	BSY	494 047	18,5	23 577
		74/85/103	07.06→	▮ 479 307	300 / 28		494 170	18,9	24484
FT 330 .. 2.4 TDCi 4x4	2,4	103	09.07→	▮ 479 307	300 / 28		494 170	18,9	24484
FT 330 .. 2.4 TDE	2,4	66	01.00-07.06	▮ 478 303	294 / 24,5	BSY	494 047	18,5	23 577
		85	03.04-07.06	▮ 478 303	294 / 24,5	BSY	494 047	18,5	23 577
		88	01.00-07.06	▮ 478 303	294 / 24,5	BSY	494 047	18,5	23 577
		92	01.00-07.06	▮ 478 303	294 / 24,5	BSY	494 047	18,5	23 577
FT 330 .. 2.4 TDI	2,4	66/74/88	01.01-01.03	▮ 478 303	294 / 24,5				
			01.01-05.06			BSY	494 047	18,5	23 577
FT 350 .. 2.0 TDCi	2,0	92	05.02-07.06	▮ 478 303	294 / 24,5	BSY	494 047	18,5	23 577
FT 350 .. 2.0 TDE	2,0	74	08.03-07.06	▮ 478 303	294 / 24,5	BSY	494 047	18,5	23 577
FT 350 .. 2.2 TDCi	2,2	81	04.06→	▮ 479 307	300 / 28				
			04.06-01.08				494 170	18,9	24484
		85	10.08→	▮ 479 307	300 / 28				
		96/103	04.06→	▮ 479 307	300 / 28				
			04.06-01.08				494 170	18,9	24484
FT 350 .. 2.3i	2,3	103-107	12.00-07.06	▮ 478 303	294 / 24,5	BSY	494 047	18,5	23 577
		100-107	04.06→	▮ 479 307	300 / 28		494 170	18,9	24484
FT 350 .. 2.4 TD	2,4	55	01.00-09.03	▮ 478 303	294 / 24,5	BSY	494 047	18,5	23 577
FT 350 .. 2.4 TDCi	2,4	101	03.04-07.06	▮ 478 303	294 / 24,5	BSY	494 047	18,5	23 577
		74/85/103	07.06→	▮ 479 307	300 / 28		494 170	18,9	24484





◀ FORD				0 986...	0 986...	1 987...	1 987...
Transit [F_] FT 350 ..	2,4	103	09.07→	🔍 479 307	300 / 28	494 170	18,9 24484
2.4 TDCi 4x4							
FT 350 .. 2.4 TDE	2,4	66	01.00-07.06	🔍 478 303	294 / 24,5	BSY 494 047	18,5 23 577
		85	03.04-07.06	🔍 478 303	294 / 24,5	BSY 494 047	18,5 23 577
		92	01.00-07.06	🔍 478 303	294 / 24,5	BSY 494 047	18,5 23 577
FT 350 .. 2.4 TDI	2,4	66/88	01.01-01.03	🔍 478 303	294 / 24,5		
		96	01.01-05.06			BSY 494 047	18,5 23 577
			06.04-05.06			BSY 494 047	18,5 23 577
FT 350 .. 3.2 TDCi	3,2	147	08.07→	🔍 479 307	300 / 28	494 170	18,9 24484
FT 430 .. 2.4 TD	2,4	55	08.02-09.03	🔍 478 303	294 / 24,5	BSY 494 047	18,5 23 577
FT 430 .. 2.4 TDCi	2,4	101	03.04-07.06	🔍 478 303	294 / 24,5	BSY 494 047	18,5 23 577
		74/85/ 103	07.06→	🔍 479 307	300 / 28	494 170	18,9 24484
FT 430 .. 2.4 TDCi 4x4	2,4	103	09.07→	🔍 479 307	300 / 28	494 170	18,9 24484
FT 430 .. 2.4 TDE	2,4	66	08.02-07.06	🔍 478 303	294 / 24,5	BSY 494 047	18,5 23 577
		85	03.04-07.06	🔍 478 303	294 / 24,5	BSY 494 047	18,5 23 577
		92	08.02-07.06	🔍 478 303	294 / 24,5	BSY 494 047	18,5 23 577
FT 430 .. 2.4 TDI	2,4	96	06.04-05.06			BSY 494 047	18,5 23 577
FT 460 2.4 TDCi	2,4	103	07.06→	🔍 479 307	300 / 28	494 170	18,9 24484
FT 460 2.4 TDCi 4x4	2,4	103	09.07→	🔍 479 307	300 / 28	494 170	18,9 24484
FT 460 3.2 TDCi	3,2	147	08.07→	🔍 479 307	300 / 28	494 170	18,9 24484
Transit Connect [02]	1,8	81-85	05.02→	🔍 479 069	278 / 24	ATE 424 701	23 440
1.8 i							
1.8 TDCi	1,8	55/66/ 81	05.02→	🔍 479 069	278 / 24	ATE 424 701	23 440
1.8 TDDi	1,8	55	05.02→	🔍 479 069	278 / 24	ATE 424 701	23 440
Transit Euroline [E_] 2.0 i	2,0	84	08.94-07.00	5LO 🔍 478 160	254 / 24,5	BSY 460 963	18 21 470
				6LO 🔍 478 166	270 / 24,1	BSY 424 492	18 21 469
				6LO,WW		BSY 460 962	18 21 469
2.5 D; DI; TD; TDI	2,5	51/56/ 63/85	08.94-08.00	5LO 🔍 478 160	254 / 24,5	BSY 460 963	18 21 470
				6LO 🔍 478 166	270 / 24,1	BSY 424 492	18 21 469
				6LO,WW		BSY 460 962	18 21 469
[F_] 2.0 TDCi	2,0	92	05.02-07.06	🔍 478 299	276 / 24,5	494 037	17,8 23840
2.0 TDE	2,0	74	08.00-07.06	🔍 478 299	276 / 24,5	494 037	17,8 23840
2.2 TDCi	2,2	81/85/ 96/103	04.06→	🔍 479 392	280 / 28		
Transit Nugget [E_] 2.0 i	2,0	84	08.94-07.00	5LO 🔍 478 160	254 / 24,5	BSY 460 963	18 21 470
				6LO 🔍 478 166	270 / 24,1	BSY 424 492	18 21 469
				6LO,WW		BSY 460 962	18 21 469
2.5 D; DI; TD; TDI	2,5	51/56/ 63/85	08.94-08.00	5LO 🔍 478 160	254 / 24,5	BSY 460 963	18 21 470
				6LO 🔍 478 166	270 / 24,1	BSY 424 492	18 21 469
				6LO,WW		BSY 460 962	18 21 469
[F_] 2.0 TDCi	2,0	92	05.02-07.06	🔍 478 299	276 / 24,5	494 037	17,8 23840
2.0 TDE	2,0	74	08.00-07.06	🔍 478 299	276 / 24,5	494 037	17,8 23840
2.2 TDCi	2,2	81/85/ 96/103	04.06→	🔍 479 392	280 / 28		
Transit Tourneo [E_] 2.0 i	2,0	84	08.94-07.00	5LO 🔍 478 160	254 / 24,5	BSY 460 963	18 21 470
				6LO 🔍 478 166	270 / 24,1	BSY 424 492	18 21 469
				6LO,WW		BSY 460 962	18 21 469
2.5 D; DI; TD; TDI	2,5	51/56/ 63/85	08.94-08.00	5LO 🔍 478 160	254 / 24,5	BSY 460 963	18 21 470
				6LO 🔍 478 166	270 / 24,1	BSY 424 492	18 21 469
				6LO,WW		BSY 460 962	18 21 469
[F_] 2.0 TDCi	2,0	92	05.02-07.06	🔍 478 299	276 / 24,5	494 037	17,8 23840
2.0 TDE	2,0	74	08.00-07.06	🔍 478 299	276 / 24,5	494 037	17,8 23840
2.2 TDCi	2,2	81/85/ 96/103	04.06→	🔍 479 392	280 / 28		

GAZ

Gazel 2.1 TD	2,1	70/81	09.97→			GIR 424 012	20 083
2.3	2,3	80,9	11.97→			GIR 424 012	20 083



				0 986...	0 986...			1 987...	1 987...
Gazel 2.3 16V	2,3	73,5	01.97→		GIR	424 012	20 083		
2.4	2,4	66,2/ 73,5	09.97→		GIR	424 012	20 083		
2.4 L DOHC	2,4	112	07.05→		GIR	424 012	20 083		
2.4 TD	2,4	75	01.07→		GIR	424 012	20 083		
2.5	2,4	73,5	01.97→		GIR	424 012	20 083		
2.5 i	2,5	98	01.08→		GIR	424 012	20 083		
		111,8	09.01→		GIR	424 012	20 083		
2.7 TD	2,7	80	01.07→		GIR	424 012	20 083		
2.8 TD	2,8	92	03.03→		GIR	424 012	20 083		
2.9	2,9	70	01.99→		GIR	424 012	20 083		
2.9 i	2,9	85	04.99→		GIR	424 012	20 083		
2.9 i 16V	2,9	85	01.03→		GIR	424 012	20 083		
Sobol 2.1 TD	2,1	70/81	09.97→		GIR	424 012	20 083		
2.3	2,3	80,9	09.97→		GIR	424 012	20 083		
2.4 L DOHC	2,4	112	01.94→		GIR	424 012	20 083		
2.5 i	2,5	98	01.08→		GIR	424 012	20 083		
		111,8	09.01→		GIR	424 012	20 083		

HONDA

Civic Pro 1.3	1,3	60	11.92-03.96		AKE	461 126	15	21 699	
1.5	1,5	67	10.92-03.96		AKE	461 126	15	21 699	
Partner 1.3 i	1,3	67	02.96-08.03	478 115	240 / 21	AKE	461 126	15	21 699

HYUNDAI

Grace 2.4 i Super	2,4	90	10.95→	478 664	253 / 20	MND	424 368	19	23 083
2.5 D	2,5	59	10.95→	478 664	253 / 20	MND	424 368	19	23 083
2.5 Intercooler	2,5	63	10.95→	478 664	253 / 20	MND	424 368	19	23 083
H 100 2.4 i	2,4	90	07.93-03.00	478 664	253 / 20	MND	424 368	19	23 083
2.5 D	2,5	55	02.93-12.94	478 664	253 / 20	MND	424 368	19	23 083
		57	07.94-03.00	478 664	253 / 20	MND	424 368	19	23 083
		59	07.93-03.00	478 664	253 / 20	MND	424 368	19	23 083
2.5 Intercooler	2,5	57	07.94-03.00	478 664	253 / 20	MND	424 368	19	23 083
2.5 TCI	2,5	63	09.96-09.04	478 664	253 / 20	MND	424 368	19	23 083
		70	10.04→	478 664	253 / 20	MND	424 368	19	23 083
2.5 TD	2,5	59	07.93-03.00 OAA	478 663	254 / 24	MND	424 670	17	23 536
H-1 2.4 i	2,4	82	10.97-05.07	478 663	254 / 24	MND	424 670	17	23 536
2.5 CRDi	2,5	103	08.03-12.06 TW			MND	424 670	17	23 536
2.5 D	2,5	57	10.97-08.02 OAA	478 663	254 / 24	MND	424 670	17	23 536
2.5 TCI	2,5	73-74	10.99-12.06 OAA	478 663	254 / 24	MND	424 670	17	23 536
Satellite 2.4 i	2,4	82	10.97-05.07	478 663	254 / 24	MND	424 670	17	23 536
i4WD	2,4	82	10.97-05.07			MND	424 670	17	23 536
2.5 D Turbo	2,5	63	10.97-08.02 OAA	478 663	254 / 24	MND	424 670	17	23 536
2.5 D Turbo 4WD	2,5	63	10.97-08.02			MND	424 670	17	23 536
Starex 2.4 i	2,4	82-86	10.97-05.07	478 663	254 / 24	MND	424 670	17	23 536
2.4 i 4WD	2,4	82-86	10.97-05.07			MND	424 670	17	23 536
2.5 CRDi	2,5	103	10.02→ TW			MND	424 670	17	23 536
2.5 D	2,5	57	10.97-08.02 OAA	478 663	254 / 24	MND	424 670	17	23 536
2.5 D Turbo	2,5	59	10.97-08.02 OAA	478 663	254 / 24	MND	424 670	17	23 536
2.5 D Turbo 4WD	2,5	59	10.97-08.02			MND	424 670	17	23 536
2.5 TCI	2,5	74	10.02→ TW			MND	424 670	17	23 536

INNOCENTI (NUOVA INNOCENTI)

Elba 1.7 D	1,7	42	09.92-12.96	478 353	240,5 / 12	ATE	460 986	18	21 193
-------------------	-----	----	-------------	---------	------------	-----	----------------	----	--------





0 986... 0 986... 1 987... 1 987...

ISUZU

Midi 2.0	2,0	61	01.89-12.96	₱ 478 658	250 / 18				
			01.89-12.99			SUM	424 157	21 115	
2.0D Turbo	2,0	51	01.89-12.96	₱ 478 658	250 / 18				
			01.89-12.99			SUM	424 157	21 115	
2.0 4WD	2,0	61	01.89-12.96	₱ 478 658	250 / 18				
			01.89-12.99			SUM	424 157	21 115	
2.2 D	2,2	45	01.89-12.96	₱ 478 658	250 / 18				
			01.89-12.99			SUM	424 157	21 115	
2.2 D 4WD	2,2	45	01.89-12.96	₱ 478 658	250 / 18				
			01.89-12.99			SUM	424 157	21 115	
2.4 D	2,4	56	01.94-12.96	₱ 478 658	250 / 18				
			01.94-12.99			SUM	424 157	21 115	
Pick-Up [KB] 1.6	1,6	59	01.84-12.87	₱ 478 658	250 / 18				
1.9	1,9	58	02.84-12.87	₱ 478 658	250 / 18				
2.0 D	2,0	34	01.84-12.87	₱ 478 658	250 / 18				
2.2 D	2,2	39	04.86-12.87	₱ 478 658	250 / 18				

IVECO

Daily L 29 L 10	2,3	70	09.02-03.06	₱ 479 162	276 / 22	BRB	424 833	17	29 121
L 29 L 12	2,3	85	09.02-03.06	₱ 479 162	276 / 22	BRB	424 833	17	29 121
Daily Chassi 35 .13	2,8	92	10.05-07.07	₱ 478 885	290 / 22				
40 .13	2,8	92	10.05-07.07	₱ 478 885	290 / 22				
50 .13	2,8	92	10.05-07.07	₱ 478 885	290 / 22				
Daily Furgao 38 .13	2,8	92	10.05-07.07	₱ 478 885	290 / 22				
40 .13	2,8	92	10.05-07.07	₱ 478 885	290 / 22				
50 .13	2,8	92	10.05-07.07	₱ 478 885	290 / 22				
Daily, Grinta	2,5	62	02.85-06.89	₱ 478 885	290 / 22				
Bo-Frost 35-10 Turbo									
Duty 35-8	2,5	55	07.89-06.90	STB	₱ 478 742	267 / 14	BRB	424 144	18,3 29 041
				4SB	₱ 478 885	290 / 22	BRB	424 144	18,3 29 041
New Daily A45-10 Turbo	2,5	76	07.89-04.96				PEO	424 176	18 21 186
New Daily 30-8	2,5	55	02.91-04.96		₱ 478 647	267 / 14,5			
				TW			BRB	424 240	18,3 29 037
	60		05.96-03.98		₱ 478 647	267 / 14,5			
				TW			BRB	424 240	18,3 29 037
				TW			DEP	424 044	18 20 359
	2,8	62	04.98-05.99		₱ 478 647	267 / 14,5			
New Daily 35-8	2,5	55	02.91-04.96	STB	₱ 478 742	267 / 14	BRB	424 144	18,3 29 041
				4SB	₱ 478 885	290 / 22	BRB	424 144	18,3 29 041
	60		05.96-03.98	STB	₱ 478 742	267 / 14	BRB	424 144	18,3 29 041
				4SB	₱ 478 885	290 / 22	BRB	424 144	18,3 29 041
	2,8	62	04.98-05.99	STB	₱ 478 742	267 / 14			
				4SB	₱ 478 885	290 / 22			
New Daily 35-10 Turbo	2,5	66,1-68,9	07.91-04.96		₱ 478 742	267 / 14			
				R14			BRB	424 144	18,3 29 041
	70		05.85-09.90		₱ 478 742	267 / 14			
			01.90-09.90	R14			BRB	424 144	18,3 29 041
	77,5-83		01.93-05.96		₱ 478 742	267 / 14			
New Daily 35-10 Turbo I.D.	2,5	80	07.92-04.97		₱ 478 742	267 / 14			
				R14			BRB	424 144	18,3 29 041
New Daily 40-8	2,5	55	07.89-04.96		₱ 478 742	267 / 14			
New Daily 45-10 Turbo	2,5	76	09.89-04.96		₱ 478 649	280 / 16			
Restyling 30-8	2,4	53	04.86-06.89				DEP	424 044	18 20 359
Restyling 35-8	2,4	53	04.86-06.89				BRB	424 145	21 188
Restyling 35-10 Turbo	2,4	67	02.85-06.89		₱ 478 742	267 / 14			
Restyling 40-8	2,4	53	01.83-06.89		₱ 478 742	267 / 14			474 188

				0 986...	0 986...	1 987...	1 987...
Daily, Grinta	2,4	67	02.85-06.89	▮ 478 649	280 / 16		
Restyling 45-10 Turbo							
Restyling 49-10 Turbo	2,4	67	02.85-06.89	▮ 478 649	280 / 16	PEO 424 176	18 21 186
Turbo Daily A40-10	2,8	76	05.96-05.99	4SB	▮ 478 885	290 / 22	
Turbo			Fg.no. →5296969 →D137847	05.96-05.99		BRB 424 833	17 29 121
Turbo Daily A40-12	2,8	90	05.96-05.99	4SB	▮ 478 885	290 / 22	
Turbo			Fg.no. →5296969 →D137847	05.96-05.99		BRB 424 833	17 29 121
Turbo Daily A45-10	2,8	76	05.96-05.99	4SB	▮ 478 885	290 / 22	
Turbo			Fg.no. →5296969 →D137847	05.96-05.99		BRB 424 833	17 29 121
Turbo Daily A45-12	2,5	85	06.90-04.96			PEO 424 176	18 21 186
Turbo			Fg.no. 2075708→ 5980633→	06.90-04.96	▮ 478 649	280 / 16	
	2,8	90	05.96-05.99	4SB	▮ 478 885	290 / 22	
			Fg.no. →5296969 →D137847	05.96-05.99		BRB 424 833	17 29 121
Turbo Daily A49-10	2,8	76	05.96-05.99	4SB	▮ 478 885	290 / 22	
Turbo			Fg.no. →5296969 →D137847	05.96-05.99		BRB 424 833	17 29 121
Turbo Daily 30-10	2,5	76,5	02.85-06.89		▮ 478 647	267 / 14,5	BRB 424 240 18,3 29 037
Turbo	2,8	76	Fg.no. →5129027	05.96-05.99			BRB 424 240 18,3 29 037
			Fg.no. 5129028→	05.96-05.99			BRB 424 768 18,3 23 139
Turbo Daily 35-10	2,5	80	07.92-04.97	STB	▮ 478 742	267 / 14	
Turbo				4SB	▮ 478 885	290 / 22	
			Fg.no. →5129027	07.92-04.97		BRB 424 144	18,3 29 041
			Fg.no. →5296969 →D137847	07.92-04.97		BRB 424 833	17 29 121
	2,8	76	05.96-05.99	STB	▮ 478 742	267 / 14	
				4SB	▮ 478 885	290 / 22	
			Fg.no. →5129027	05.96-05.99		BRB 424 144	18,3 29 041
			Fg.no. →5296969 →D137847	05.96-05.99		BRB 424 833	17 29 121
Turbo Daily 35-12	2,5	85	10.90-04.96	R14	▮ 478 742	267 / 14	APD, 424 044 18 20 359
Turbo				R14			BRB 424 144 18,3 29 041
				R16	▮ 478 649	280 / 16	PEO 424 176 18 21 186
	2,8	90	05.96-05.99	STB	▮ 478 742	267 / 14	
				4SB	▮ 478 885	290 / 22	
			Fg.no. →5129027	05.96-05.99		BRB 424 144	18,3 29 041
			Fg.no. →5296969 →D137847	05.96-05.99		BRB 424 833	17 29 121
Turbo Daily 40-10	2,8	76	05.96-05.99			PEO 424 176	18 21 186
Turbo 4x4							
Turbo Daily 49-10	2,8	76	05.96-05.99	4SB	▮ 478 885	290 / 22	
Turbo			Fg.no. →5296969 →D137847	05.96-05.99		BRB 424 833	17 29 121
Turbo Daily 49-12	2,5	85	06.90-04.96			PEO 424 176	18 21 186
Turbo			Fg.no. 2075708→ 5980633→	06.90-04.96	▮ 478 649	280 / 16	
Turbo Daily	2,8	90	05.96-05.99	4SB	▮ 478 885	290 / 22	
			Fg.no. →5296969 →D137847	05.96-05.99		BRB 424 833	17 29 121
35-9	2,0	60	12.81-12.87				
35-9	2,0	60	09.86-12.87			BRB 424 144	18,3 29 041 474 188
35-11	2,8	78	01.99-07.99		▮ 478 885	290 / 22	
49-11	2,8	78	01.99-07.99		▮ 478 885	290 / 22	
Scudato 35.10	2,8	76	01.99-12.03		▮ 478 885	290 / 22	
49.12	2,8	76	11.99-05.02		▮ 478 885	290 / 22	

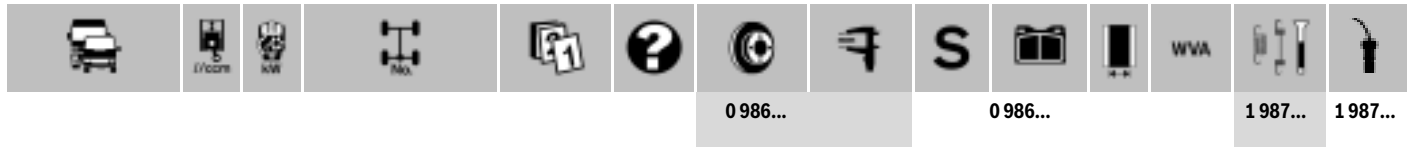

JEEP

Comanche [MJ]	2,1	64	01.87-12.90 AA	478 694	280 / 22				
2.1 D Turbo			01.88-12.90			KEL	424 273	21 820	
2.5	2,5	90	01.87-12.90 AA	478 694	280 / 22				
			01.88-12.92			KEL	424 273	21 820	
4.0i	4,0	129	01.87-12.90 AA	478 694	280 / 22				
			01.88-12.96			KEL	424 273	21 820	

KIA

Besta [TA] 2.2 D 2WD	2,2	48	03.90-07.00			AKE	460 020	15	20 002
Pregio [TB] 2.5 Tci	2,5	69	08.01-03.03			SUM	424 714	16,1	23 649
2.7 D	2,7	60	02.97-01.99			SUM	424 726		23 484
3.0 D	3,0		02.97-01.99			SUM	424 726		23 484

LEYLAND-FREIGHT ROVER

Sherpa 300	2,0	73	09.83-03.89	478 820	276 / 14,3				
310	2,5	49	11.86-12.98	478 820	276 / 14,3				
350	2,5	54	06.82-03.89	478 820	276 / 14,3				
400	2,5	49	11.86-12.98	478 820	276 / 14,3				

MAZDA

Familia Van 1.3	1,3	47	11.85-08.94	478 249	238 / 18	SUM	460 390	15	20 039
1.7 D	1,7	43	11.85-08.94	478 249	238 / 18	SUM	460 390	15	20 039
Serie B [UF]	2,5	57-63	03.96-05.99	478 699	272 / 22				
2500 12V D 4x4									
2600 i 12V 4x4	2,6	92	03.96-05.99	478 699	272 / 22				
[UN] 2200	2,2	60	02.99-03.06			KEL	424 720	16,5	23 540
2200 4x4	2,2	68	06.99-03.06			KEL	424 720	16,5	23 540
2500 D	2,5	57	02.99-03.06			KEL	424 720	16,5	23 540
2500 D Turbo	2,5	62	09.01-03.06			KEL	424 720	16,5	23 540
2500 D Turbo 4x4	2,5	62	09.01-03.06			KEL	424 720	16,5	23 540
		80	02.99-03.06			KEL	424 720	16,5	23 540
2500 D 4x4	2,5	57	02.99-03.06			KEL	424 720	16,5	23 540
2600 4x4	2,6	90	02.99-03.06			KEL	424 720	16,5	23 540
Serie E 1.8	1,8	67	01.84-02.88	478 802	256 / 20,1				
2.0	2,0	60-63	12.87-03.95			AKE	460 020	15	20 002
		60-65	01.84-02.88 DOP			AKE	460 020	15	20 002
				478 802	256 / 20,1				
			WW	478 697	268 / 20				
			02.84-09.84			AKE	460 020	15	20 002
		63	01.84-01.88 DOP			AKE	460 020	15	20 002
				478 802	256 / 20,1				
			WW	478 697	268 / 20				
2.0i	2,0	70	08.91-04.97			AKE	460 020	15	20 002
2.0 4WD	2,0	60-63	12.87-07.89			AKE	460 020	15	20 002
		60-65	03.86-02.88			AKE	460 020	15	20 002
2.2 D	2,2	44	02.84-08.88			AKE	460 020	15	20 002
			07.84-02.88	478 802	256 / 20,1				
			WW	478 697	268 / 20				
		44-47	12.87-04.97			AKE	460 020	15	20 002
		46	01.84-02.88			AKE	460 020	15	20 002
				478 802	256 / 20,1				
			WW	478 697	268 / 20				
2.2 D 4WD	2,2	44-47	01.88-04.97			AKE	460 020	15	20 002



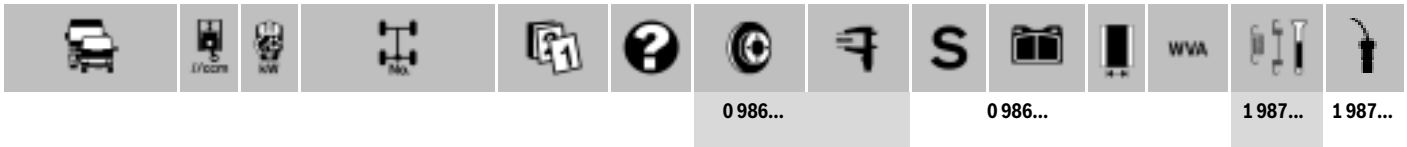

MERCEDES-BENZ

					0 986...		0 986...		1 987...	1 987...
MB 100	2,0	43	12.80-06.89		▮ 478 357	238,5 / 16	BSY	460 947	14	21 573
100 D	2,4	53-56	09.87-08.91		▮ 478 357	238,5 / 16				
				FKP			BSY	460 947	14	21 573
			Fg.no. BM: 631.349	09.87-08.91	▮ 478 643	263 / 24				
		55		09.91-01.96	▮ 478 357	238,5 / 16				
							BSY	460 947	14	21 573
			Fg.no. BM: 631.349	09.91-01.96	▮ 478 643	263 / 24				
120	2,4	55	01.87-12.90		▮ 478 357	238,5 / 16	BSY	460 947	14	21 573
130	2,4	53	12.80-09.83		▮ 478 357	238,5 / 16	BSY	460 947	14	21 573
140	2,4	53	10.83-12.86		▮ 478 357	238,5 / 16	BSY	460 947	14	21 573
		56	01.87-06.90		▮ 478 357	238,5 / 16	BSY	460 947	14	21 573
150	2,4	53	12.80-09.83				BSY	460 947	14	21 573
					▮ 478 643	263 / 24				
160	2,4	56	01.87-06.90		▮ 478 643	263 / 24				
170	2,4	53	12.80-09.83		▮ 478 643	263 / 24	BSY	460 947	14	21 573
180	2,4	53	10.83-12.86		▮ 478 643	263 / 24				
		56	01.87-01.96		▮ 478 643	263 / 24				
O 100 CITY	2,9	70	01.94→		▮ 478 643	263 / 24				
Sprinter 310 D	2,5	70	09.96-05.01		▮ 478 849	276 / 22	ATE, TEJ	424 218	20,6	21 576
				TEJ						474 309
311 CDI	2,2	80	06.01-12.04		▮ 478 849	276 / 22	ATE, PET	424 832	20	29 153
							ATE, TEJ	424 218	20,6	21 576
				TEJ						474 309
312 D	2,5	77	10.99-05.01		▮ 478 849	276 / 22	ATE, TEJ	424 218	20,6	21 576
				TEJ						474 309
		85	08.99-05.01		▮ 478 849	276 / 22	ATE, TEJ	424 218	20,6	21 576
				TEJ						474 309
313 CDI	2,2	95	06.01→		▮ 478 849	276 / 22	ATE, PET	424 832	20	29 153
							ATE, TEJ	424 218	20,6	21 576
				TEJ						474 309
412 D	2,5	85	10.99-05.01		▮ 478 849	276 / 22	ATE, TEJ	424 218	20,6	21 576
				TEJ						474 309
[NCV3] 209 CDI	2,1	65	04.06→		▮ 479 294	300 / 28	BRB	494 121		29192
211 CDI	2,1	80	04.06→		▮ 479 294	300 / 28	BRB	494 121		29192
213 CDI	2,1	95	04.06→		▮ 479 294	300 / 28	BRB	494 121		29192
215 CDI	2,1	110	04.06→		▮ 479 294	300 / 28	BRB	494 121		29192
218 CDI	3,0	135	04.06→		▮ 479 294	300 / 28	BRB	494 121		29192
224	3,5	190	04.06→		▮ 479 294	300 / 28	BRB	494 121		29192
309 CDI	2,1	65	04.06→		▮ 479 294	300 / 28	BRB	494 121		29192
311 CDI	2,1	80	04.06→		▮ 479 294	300 / 28	BRB	494 121		29192
313 CDI	2,1	95	04.06→		▮ 479 294	300 / 28	BRB	494 121		29192
315 CDI	2,1	110	04.06→		▮ 479 294	300 / 28	BRB	494 121		29192
318 CDI	3,0	135	04.06→		▮ 479 294	300 / 28	BRB	494 121		29192
324	3,5	190	04.06→		▮ 479 294	300 / 28	BRB	494 121		29192
411 CDI	2,1	80	04.06→		▮ 479 294	300 / 28	BRB	494 121		29192
415 CDI	2,1	110	04.06→		▮ 479 294	300 / 28	BRB	494 121		29192
418 CDI	3,0	135	04.06→		▮ 479 294	300 / 28	BRB	494 121		29192
424	3,5	190	04.06→		▮ 479 294	300 / 28	BRB	494 121		29192
509 CDI	2,1	65	04.06→		▮ 479 294	300 / 28	BRB	494 121		29192
511 CDI	2,1	80	04.06→		▮ 479 294	300 / 28	BRB	494 121		29192
515 CDI	2,1	110	04.06→		▮ 479 294	300 / 28	BRB	494 121		29192
518 CDI	3,0	135	04.06→		▮ 479 294	300 / 28	BRB	494 121		29192



				0 986...	0 986...	1 987...	1 987...	
◀ MERCEDES-BENZ								
Sprinter [NCV3] 524	3,5	190	04.06→	479 294	300 / 28	BRB	494 121 29192	473 037
[T1N] 208 CDI	2,2	60	04.00-05.06	478 849	276 / 22			474 969
						ATE,	424 832 20 29 153	
						BSY,		
						PET		
						ATE,	424 218 20,6 21 576	
						GFR,		
						TEJ		
			GFR,TEJ					474 309
208 D	2,3	58-60	02.95-03.00			ATE,	424 832 20 29 153	
						BSY,		
						PET		
						ATE,	424 218 20,6 21 576	
						GFR,		
						TEJ		
			GFR,TEJ					474 309
				478 849	276 / 22			
		Comp. no. 504015/04	02.95-03.00	TNK				474 969
		Comp. no. 504015/06						
		Comp. no. 504015/07						
		Comp. no. 504015/08						
		Comp. no. 504015/50						
210 D	2,9	75	01.97-03.00			ATE,	424 832 20 29 153	474 969
						BSY,		
						PET		
						ATE,	424 218 20,6 21 576	
						GFR,		
						TEJ		
			GFR,TEJ					474 309
				478 849	276 / 22			
211 CDI	2,2	80	04.00-05.06			ATE,	424 832 20 29 153	
						BSY,		
						PET		
						ATE,	424 218 20,6 21 576	
						GFR,		
						TEJ		
			GFR,TEJ					474 309
				478 849	276 / 22			
		Comp. no. 504015/04	04.00-05.06	TNK				474 969
		Comp. no. 504015/06						
		Comp. no. 504015/07						
		Comp. no. 504015/08						
		Comp. no. 504015/50						
212 D	2,9	90	02.95-03.00			ATE,	424 832 20 29 153	474 969
						BSY,		
						PET		
						ATE,	424 218 20,6 21 576	
						GFR,		
						TEJ		
			GFR,TEJ					474 309
				478 849	276 / 22			
213 CDI	2,2	95	04.00-05.06			ATE,	424 832 20 29 153	
						BSY,		
						PET		
						ATE,	424 218 20,6 21 576	
						GFR,		
						TEJ		
			GFR,TEJ					474 309
				478 849	276 / 22			



						0 986...	0 986...	1 987...	1 987...
Sprinter [T1N]	2,2	95	Comp. no. 504015/04 Comp. no. 504015/06 Comp. no. 504015/07 Comp. no. 504015/08 Comp. no. 504015/50	04.00-05.06	TNK				474 969
214	2,3	105		02.95-03.00			ATE, 424 832 20 29 153 GFR, TEJ		474 969
					GFR,TEJ		ATE, 424 218 20,6 21 576 TEJ		474 309
		105-108		04.00-05.06		478 849 276 / 22			474 969
					GFR,TEJ		ATE, 424 832 20 29 153 BSY, PET		
					GFR,TEJ		ATE, 424 218 20,6 21 576 GFR, TEJ		474 309
						478 849 276 / 22			
214 NGT	2,3	95		04.00-05.06			ATE, 424 832 20 29 153 BSY, PET		474 969
					GFR,TEJ		ATE, 424 218 20,6 21 576 GFR, TEJ		474 309
						478 849 276 / 22			
216 CDI	2,7	115		04.00-05.06			ATE, 424 832 20 29 153 BSY, PET		474 969
					GFR,TEJ		ATE, 424 218 20,6 21 576 GFR, TEJ		474 309
						478 849 276 / 22			
308 CDI	2,2	60		04.00-05.06			ATE, 424 832 20 29 153 BSY, PET		474 969
					GFR,TEJ		ATE, 424 218 20,6 21 576 GFR, TEJ		474 309
						478 849 276 / 22			
			Front axle 730.415	04.00-05.06		478 849 276 / 22			
			Front axle 730.415	04.00-05.06		479 212 285 / 22			
308 D	2,3	58		02.95-03.00			ATE, 424 832 20 29 153 BSY, PET		474 969
					GFR,TEJ		ATE, 424 218 20,6 21 576 GFR, TEJ		474 309
			Front axle 730.415	02.95-03.00		478 849 276 / 22			
			Front axle 730.415	02.95-03.00		479 212 285 / 22			



				0 986...	0 986...	1 987...	1 987...
◀ MERCEDES-BENZ							
Sprinter [T1N] 310 D	2,9	75	01.97-03.00				474 969
					ATE, 424 832	20 29 153	
					BSY,		
					PET		
					ATE, 424 218	20,6 21 576	
					GFR,		
					TEJ		
			GFR,TEJ				474 309
			Front axle 730.415	01.97-03.00	478 849	276 / 22	
			Front axle 730.415	01.97-03.00	479 212	285 / 22	
311 CDI	2,1	80	08.02-05.06				474 969
							473 007
					ATE, 424 832	20 29 153	
					BSY,		
					PET		
					ATE, 424 218	20,6 21 576	
					GFR,		
					TEJ		
			GFR,TEJ				474 309
			Front axle 730.415	08.02-05.06	478 849	276 / 22	
			Front axle 730.415	08.02-05.06	479 212	285 / 22	
							474 969
							473 007
					ATE, 424 832	20 29 153	
					BSY,		
					PET		
					ATE, 424 218	20,6 21 576	
					GFR,		
					TEJ		
			GFR,TEJ				474 309
			Front axle 730.415	04.00-05.06	478 849	276 / 22	
			Front axle 730.415	04.00-05.06	479 212	285 / 22	
							474 969
							473 007
					ATE, 424 832	20 29 153	
					BSY,		
					PET		
					ATE, 424 218	20,6 21 576	
					GFR,		
					TEJ		
			GFR,TEJ				474 309
			Front axle 730.415	04.00-05.06	478 849	276 / 22	
			Front axle 730.415	04.00-05.06	479 212	285 / 22	
312 D	2,9	90	02.95-03.00				474 969
							473 007
					ATE, 424 832	20 29 153	
					BSY,		
					PET		
					ATE, 424 218	20,6 21 576	
					GFR,		
					TEJ		
			GFR,TEJ				474 309
			Front axle 730.415	02.95-03.00	478 849	276 / 22	
			Front axle 730.415	02.95-03.00	479 212	285 / 22	
313 CDI	2,2	95	04.00-05.06				474 969
							473 007
					ATE, 424 832	20 29 153	
					BSY,		
					PET		
					ATE, 424 218	20,6 21 576	
					GFR,		
					TEJ		
			GFR,TEJ				474 309
			Front axle 730.415	04.00-05.06	478 849	276 / 22	
			Front axle 730.415	04.00-05.06	479 212	285 / 22	
314	2,3	105-108	02.95-05.06				474 969
							473 007
					ATE, 424 832	20 29 153	
					BSY,		
					PET		
					ATE, 424 218	20,6 21 576	
					GFR,		
					TEJ		
			GFR,TEJ				474 309
			Front axle 730.415	02.95-05.06	478 849	276 / 22	



					0 986...	0 986...	1 987...	1 987...	
Sprinter [T1N]	314	2,3	105-108	Front axle 730.415	02.95-05.06	479 212	285 / 22		
314 NGT		2,3	95		04.00-05.06				474 969
				AA					473 007
								ATE, 424 832	20 29 153
								BSY, PET	
								ATE, 424 218	20,6 21 576
								GFR, TEJ	
				GFR,TEJ					474 309
				Front axle 730.415	04.00-05.06	478 849	276 / 22		
				Front axle 730.415	04.00-05.06	479 212	285 / 22		
316 CDI		2,7	115		04.00-05.06				474 969
				AA					473 007
								ATE, 424 832	20 29 153
								BSY, PET	
								ATE, 424 218	20,6 21 576
								GFR, TEJ	
				GFR,TEJ					474 309
				Front axle 730.415	04.00-05.06	478 849	276 / 22		
				Front axle 730.415	04.00-05.06	479 212	285 / 22		
408 CDI		2,2	60		04.00-05.06				474 969
								ATE, 424 832	20 29 153
								GFR, TEJ	
								ATE, 424 218	20,6 21 576
								TEJ	
				GFR,TEJ					474 309
				Front axle 730.606	04.00-05.06	478 849	276 / 22		
408 D		2,3	58		02.95-03.00			ATE, 424 832	20 29 153
								BSY, PET	
								ATE, 424 218	20,6 21 576
								GFR, TEJ	
				GFR,TEJ					474 309
				Comp. no. 504015/04	02.95-03.00				
				Comp. no. 504015/06					
				Comp. no. 504015/07					
				Comp. no. 504015/08					
				Comp. no. 504015/50					
				Front axle 730.606	02.95-03.00	478 849	276 / 22		
410 D		2,9	75		01.97-03.00			ATE, 424 832	20 29 153
								BSY, PET	
								ATE, 424 218	20,6 21 576
								GFR, TEJ	
				GFR,TEJ					474 309
				Front axle 730.606	01.97-03.00	478 849	276 / 22		
411 CDI		2,2	80		04.00-05.06			ATE, 424 832	20 29 153
				AA				BSY, PET	
								ATE, 424 218	20,6 21 576
								GFR, TEJ	
				GFR,TEJ					474 309



				0 986...	0 986...	1 987...	1 987...
◀ MERCEDES-BENZ							
Sprinter [T1N]	2,2	80	Comp. no. 504015/04 Comp. no. 504015/06 Comp. no. 504015/07 Comp. no. 504015/08 Comp. no. 504015/50	04.00-05.06 TNK			474 969
411 CDI			Front axle 730.606	04.00-05.06	478 849	276 / 22	
412 D	2,9	90		02.95-03.00			474 969
							ATE, 424 832 20 29 153 BSY, PET
							ATE, 424 218 20,6 21 576 GFR, TEJ
				GFR,TEJ			474 309
			Front axle 730.606	02.95-03.00	478 849	276 / 22	
413 CDI	2,2	95		04.00-05.06 AA			473 007
							ATE, 424 832 20 29 153 BSY, PET
							ATE, 424 218 20,6 21 576 GFR, TEJ
				GFR,TEJ			474 309
			Comp. no. 504015/04 Comp. no. 504015/06 Comp. no. 504015/07 Comp. no. 504015/08 Comp. no. 504015/50	04.00-05.06 TNK			474 969
			Front axle 730.606	04.00-05.06	478 849	276 / 22	
414	2,3	105-108		02.95-05.06			474 969
				AA			473 007
							ATE, 424 832 20 29 153 BSY, PET
							ATE, 424 218 20,6 21 576 GFR, TEJ
				GFR,TEJ			474 309
			Front axle 730.606	02.95-05.06	478 849	276 / 22	
416 CDI	2,7	115		04.00-05.06			474 969
				AA			473 007
							ATE, 424 832 20 29 153 BSY, PET
							ATE, 424 218 20,6 21 576 GFR, TEJ
				GFR,TEJ			474 309
			Front axle 730.606	04.00-05.06	478 849	276 / 22	
616 CDI	2,7	115		02.01-05.06			474 969
							ATE, 424 832 20 29 153 BSY, PET, TEX
							ATE, 424 218 20,6 21 576 GFR, TEJ
				GFR,TEJ			474 309
Vario [T2W]	4,2	75	Front axle 730.604	09.96-01.01	478 456	304 / 30	GIR, 468 350 21,5 29 835 LUC
0 810			Front axle 730.605,712	09.96-01.01	478 457	324 / 30	GIR, 468 350 21,5 29 835 LUC



					0 986...	0 986...				1 987...	1 987...	
Vario [T2W]	2,9	90	Front axle 730.604	09.96-01.01	▮ 478 456	304 / 30	FDO, GIR	468 350	21,5	29 835		474 969
			Front axle 730.605,712	09.96-01.01	▮ 478 457	324 / 30	FDO, GIR	468 350	21,5	29 835		474 969
0 814	4,2	100	Front axle 730.604	09.96-01.01	▮ 478 456	304 / 30	GIR, LUC	468 350	21,5	29 835		
			Front axle 730.605,712	09.96-01.01	▮ 478 457	324 / 30	GIR, LUC	468 350	21,5	29 835		
0 815	4,2	112	Front axle 730.604	09.96-01.01	▮ 478 456	304 / 30	GIR, LUC	468 350	21,5	29 835		
			Front axle 730.605,712	09.96-01.01	▮ 478 457	324 / 30	GIR, LUC	468 350	21,5	29 835		
512 D	2,9	90	Front axle 730.412	09.96-01.01	▮ 478 849	276 / 22	FDO, GIR	468 350	21,5	29 835		474 969
			Front axle 730.604	09.96-01.01	▮ 478 456	304 / 30	FDO, GIR	468 350	21,5	29 835		474 969
			Front axle 730.605,712	09.96-01.01	▮ 478 457	324 / 30	FDO, GIR	468 350	21,5	29 835		474 969
612 D	2,9	90	Front axle 730.604	09.96-01.01	▮ 478 456	304 / 30	FDO, GIR	468 350	21,5	29 835		474 969
			Front axle 730.605,712	09.96-01.01	▮ 478 457	324 / 30	FDO, GIR	468 350	21,5	29 835		474 969
613 D	4,2	95	Front axle 730.604	09.06→	▮ 478 456	304 / 30	GIR, LUC	468 350	21,5	29 835		
			Front axle 730.605,712	09.06→	▮ 478 457	324 / 30	GIR, LUC	468 350	21,5	29 835		
614 D	4,2	100	Front axle 730.604	09.96-09.06	▮ 478 456	304 / 30	GIR, LUC	468 350	21,5	29 835		
			Front axle 730.605,712	09.96-09.06	▮ 478 457	324 / 30	GIR, LUC	468 350	21,5	29 835		
615 D	4,2	110	Front axle 730.604	01.01-09.06	▮ 478 456	304 / 30	GIR, LUC	468 350	21,5	29 835		
			Front axle 730.605,712	01.01-09.06	▮ 478 457	324 / 30	GIR, LUC	468 350	21,5	29 835		
	112	Front axle 730.604	10.98-01.01	▮ 478 456	304 / 30	GIR, LUC	468 350	21,5	29 835			
		Front axle 730.605,712	10.98-01.01	▮ 478 457	324 / 30	GIR, LUC	468 350	21,5	29 835			
616 D	4,2	115	Front axle 730.604	09.06→	▮ 478 456	304 / 30	GIR, LUC	468 350	21,5	29 835		
			Front axle 730.605,712	09.06→	▮ 478 457	324 / 30	GIR, LUC	468 350	21,5	29 835		
618 D	4,2	130	Front axle 730.604	06.03→	▮ 478 456	304 / 30	GIR, LUC	468 350	21,5	29 835		
			Front axle 730.605,712	06.03→	▮ 478 457	324 / 30	GIR, LUC	468 350	21,5	29 835		
810 DT	4,2	75	Front axle 730.604	09.96-09.06	▮ 478 456	304 / 30	GIR, LUC	468 350	21,5	29 835		
			Front axle 730.605,712	09.96-09.06	▮ 478 457	324 / 30	GIR, LUC	468 350	21,5	29 835		
812 D	2,9	90	Front axle 730.604	09.96-09.06	▮ 478 456	304 / 30	FDO, GIR	468 350	21,5	29 835		474 969
			Front axle 730.605,712	09.96-09.06	▮ 478 457	324 / 30	FDO, GIR	468 350	21,5	29 835		474 969
813 D/DA	4,2	95	Front axle 730.604	09.06→	▮ 478 456	304 / 30	GIR, LUC	468 350	21,5	29 835		
			Front axle 730.605,712	09.06→	▮ 478 457	324 / 30	GIR, LUC	468 350	21,5	29 835		
814 D	4,2	100	Front axle 730.604	09.96-09.06	▮ 478 456	304 / 30	GIR, LUC	468 350	21,5	29 835		
			Front axle 730.605,712	09.96-09.06	▮ 478 457	324 / 30	GIR, LUC	468 350	21,5	29 835		



				0 986...	0 986...	1 987...	1 987...					
◀ MERCEDES-BENZ												
Vario [T2W]	4,2	100-112	Front axle 730.604	09.96-01.01	478 456	304 / 30	GIR, LUC	468 350	21,5	29 835		
814 DA			Front axle 730.605,712	09.96-01.01	478 457	324 / 30	GIR, LUC	468 350	21,5	29 835		
815 D	4,2	110-112	Front axle 730.604	09.96-09.06	478 456	304 / 30	GIR, LUC	468 350	21,5	29 835		
			Front axle 730.605,712	09.96-09.06	478 457	324 / 30	GIR, LUC	468 350	21,5	29 835		
815 DA	4,2	112	Front axle 730.604	01.96-01.01	478 456	304 / 30	GIR, LUC	468 350	21,5	29 835		
			Front axle 730.605,712	01.96-01.01	478 457	324 / 30	GIR, LUC	468 350	21,5	29 835		
816 D/DA	4,2	115	Front axle 730.604	09.06→	478 456	304 / 30	GIR, LUC	468 350	21,5	29 835		
			Front axle 730.605,712	09.06→	478 457	324 / 30	GIR, LUC	468 350	21,5	29 835		
818 D	4,2	130	Front axle 730.604	06.03-09.06	478 456	304 / 30	GIR, LUC	468 350	21,5	29 835		
			Front axle 730.605,712	06.03-09.06	478 457	324 / 30	GIR, LUC	468 350	21,5	29 835		
818 D/DA	4,2	130	Front axle 730.604	09.06→	478 456	304 / 30	GIR, LUC	468 350	21,5	29 835		
			Front axle 730.605,712	09.06→	478 457	324 / 30	GIR, LUC	468 350	21,5	29 835		
Vito [638 TON]	2,2	60		04.99-09.03	478 861	276 / 22	ATE, ITB, TEJ	424 218	20,6	21 576	474 309	474 969
108 CDI							BSY, FDO, JUR	494 013	20,9	23 022		474 969
				XXX				424 476		23 022		
108 D	2,3	60		11.95-09.03	478 861	276 / 22	ATE, ITB, TEJ	424 218	20,6	21 576	474 309	474 969
							BSY, JUR	494 013	20,9	23 022		474 969
				WW,XXX			BSY, JUR	424 476		23 022		
110 CDI	2,2	75		04.99-09.03	478 861	276 / 22	ATE, ITB, TEJ	424 218	20,6	21 576	474 309	474 969
							BSY, FDO, JUR	494 013	20,9	23 022		474 969
				XXX				424 476		23 022		
110 D	2,3	72		11.95-09.03	478 861	276 / 22	ATE, ITB, TEJ	424 218	20,6	21 576	474 309	474 969
							BSY, JUR	494 013	20,9	23 022		474 969
				WW,XXX			BSY, JUR	424 476		23 022		
112 CDI	2,2	90		04.99-09.03	478 861	276 / 22	ATE, ITB, TEJ	424 218	20,6	21 576	474 309	474 969
							BSY, FDO, JUR	494 013	20,9	23 022		474 969
				XXX				424 476		23 022		



				0 986...		0 986...				1 987...		1 987...	
Vito [638 TON]	2,0	95/100		11.95-09.03	▮ 478 861	276 / 22	ATE, ITB, TEJ	424 218	20,6	21 576	474 309	474 969	
113							BSY, JUR	494 013	20,9	23 022		474 969	
				WW,XXX			BSY, JUR	424 476		23 022			
114	2,3	105		11.95-09.03	▮ 478 861	276 / 22	ATE, ITB, TEJ	424 218	20,6	21 576	474 309	474 969	
							BSY, FDO, JUR	494 013	20,9	23 022		474 969	
				XXX				424 476		23 022			
[639 TON] 109 CDI	2,1	65	Fg.no. →342257	10.03-10.06	▮ 479 137	300 / 28	BSY	494 081	20,5	24007		473 006	
			Fg.no. 342258→	10.03-10.06	▮ 479 137	300 / 28	BRB	494 121		29192		473 006	
		70	Fg.no. →342257	11.06→	▮ 479 137	300 / 28	BSY	494 081	20,5	24007		473 006	
			Fg.no. 342258→	11.06→	▮ 479 137	300 / 28	BRB	494 121		29192		473 006	
111 CDI	2,1	80	Fg.no. →342257	10.03-10.06	▮ 479 137	300 / 28	BSY	494 081	20,5	24007		473 006	
			Fg.no. 342258→	10.03-10.06	▮ 479 137	300 / 28	BRB	494 121		29192		473 006	
		85	Fg.no. →342257	11.06→	▮ 479 137	300 / 28	BSY	494 081	20,5	24007		473 006	
			Fg.no. 342258→	11.06→	▮ 479 137	300 / 28	BRB	494 121		29192		473 006	
115 CDI	2,1	110	Fg.no. →342257	10.03→	▮ 479 137	300 / 28	BSY	494 081	20,5	24007		473 006	
			Fg.no. 342258→	10.03→	▮ 479 137	300 / 28	BRB	494 121		29192		473 006	
119	3,2	140	Fg.no. →342257	10.03→	▮ 479 137	300 / 28	BSY	494 081	20,5	24007		473 006	
			Fg.no. 342258→	10.03→	▮ 479 137	300 / 28	BRB	494 121		29192		473 006	
120 CDI	3,0	150	Fg.no. →342257	04.06→	▮ 479 137	300 / 28	BSY	494 081	20,5	24007		473 006	
			Fg.no. 342258→	04.06→	▮ 479 137	300 / 28	BRB	494 121		29192		473 006	
122	3,2	160	Fg.no. →342257	10.03→	▮ 479 137	300 / 28	BSY	494 081	20,5	24007		473 006	
			Fg.no. 342258→	10.03→	▮ 479 137	300 / 28	BRB	494 121		29192		473 006	
123	3,7	170	Fg.no. →342257	06.04-08.07	▮ 479 137	300 / 28	BSY	494 081	20,5	24007		473 006	
			Fg.no. 342258→	06.04-08.07	▮ 479 137	300 / 28	BRB	494 121		29192		473 006	
126	3,5	190		09.07→	▮ 479 137	300 / 28	BRB	494 121		29192		473 006	
				09.07→			BSY	494 081	20,5	24007		473 006	
2t 207 D	2,4	53		09.82-01.89	▮ 478 201	280 / 16	PEO	467 841	18	29 784	474 183	474 901	
208 D	2,3	58-60		10.88-06.95	▮ 478 201	280 / 16	PEO	467 841	18	29 784	474 183	474 901	
209 D	3,0	65		09.82-01.89	▮ 478 201	280 / 16	PEO	467 841	18	29 784	474 183	474 901	
210	2,3	70-77		08.82-06.95	▮ 478 201	280 / 16	PEO	467 841	18	29 784	474 183		
210 D	2,9	70-72		10.88-06.95	▮ 478 201	280 / 16	PEO	467 841	18	29 784	474 183	474 901	
3t 307 D	2,4	53		09.82-01.89	▮ 478 201	280 / 16	PEO	467 841	18	29 784	474 183	474 901	
308 D	2,3	58-60		10.88-06.95	▮ 478 201	280 / 16	PEO	467 841	18	29 784	474 183	474 901	
309 D	3,0	65		09.82-01.89	▮ 478 201	280 / 16	PEO	467 841	18	29 784	474 183	474 901	
310	2,3	70-77		08.82-06.95	▮ 478 201	280 / 16	PEO	467 841	18	29 784	474 183	474 901	
310 D	2,9	70-72		10.88-06.95	▮ 478 201	280 / 16	PEO	467 841	18	29 784	474 183	474 901	
4t 407 D	2,4	53		07.81-01.89			PEO	467 841	18	29 784	474 183	474 901	
			Fg.no. VA: A 025461→	07.81-01.89	▮ 478 529	280 / 22							
			Fg.no. VA:→A 025460	07.81-01.89	▮ 478 201	280 / 16							
408 D	2,3	58-60		11.88-06.95							474 183	474 901	
							PEO	467 841	18	29 784			
			Fg.no. VA: A 025461→	11.88-06.95	▮ 478 529	280 / 22							
			Fg.no. VA:→A 025460	11.88-06.95	▮ 478 201	280 / 16							
409 D	3,0	65		04.82-01.89							474 183	474 901	
							PEO	467 841	18	29 784			
			Fg.no. VA: A 025461→	04.82-01.89	▮ 478 529	280 / 22							
			Fg.no. VA:→A 025460	04.82-01.89	▮ 478 201	280 / 16							
410	2,3	70-77		08.82-06.95							474 183	474 901	
							PEO	467 841	18	29 784			
			Fg.no. VA: A 025461→	08.82-06.95	▮ 478 529	280 / 22							
			Fg.no. VA:→A 025460	08.82-06.95	▮ 478 201	280 / 16							
410 D	2,9	70-72		11.88-06.95							474 183	474 901	
							PEO	467 841	18	29 784			
			Fg.no. VA: A 025461→	11.88-06.95	▮ 478 529	280 / 22							
			Fg.no. VA:→A 025460	11.88-06.95	▮ 478 201	280 / 16							



				0 986...	0 986...	1 987...	1 987...
◀ MERCEDES-BENZ							
5t 507 D	2,4	53	Fg.no. →Vo.Achse:A 025668	04.86-04.89	478 201	280 / 16	
			Fg.no. Vo.Achse:A 025669→	04.86-04.89	478 529	280 / 22	
			Front axle 730.407	04.86-04.89			474 183
			Front axle 730.602	04.86-04.89			PEO 467 841 18 29 784 GIR 468 350 21,5 29 835
508 D	2,3	58	Fg.no. →Vo.Achse:A 025668	03.89-02.01	478 201	280 / 16	
			Fg.no. Vo.Achse:A 025669→	03.89-02.01	478 529	280 / 22	
			Front axle 730.407	03.89-02.01			474 183
			Front axle 730.602	03.89-02.01			PEO 467 841 18 29 784 GIR 468 350 21,5 29 835
510	2,3	70-77	Fg.no. →Vo.Achse:A 025668	04.86-02.01	478 201	280 / 16	
			Fg.no. Vo.Achse:A 025669→	04.86-02.01	478 529	280 / 22	
			Front axle 730.407	04.86-02.01			474 183
			Front axle 730.602	04.86-02.01			PEO 467 841 18 29 784 GIR 468 350 21,5 29 835
6t 609 D	4,0	63		02.92-09.01			GIR 468 350 21,5 29 835
			Front axle 730.602	02.92-09.01	478 406	304 / 30	
		66		04.86-02.01			GIR 468 350 21,5 29 835
			Front axle 730.602	04.86-02.01	478 406	304 / 30	
611 D	4,0	77		06.94-09.01			GIR 468 350 21,5 29 835
			Front axle 730.602	06.94-09.01	478 406	304 / 30	
7t 709 D	4,0	63		02.92-02.01			GIR 468 350 21,5 29 835
			Front axle 730.602	02.92-02.01	478 406	304 / 30	
			Front axle 730.603	02.92-02.01	478 407	324 / 30	
		66		04.86-02.01			GIR 468 350 21,5 29 835
			Front axle 730.602	04.86-02.01	478 406	304 / 30	
			Front axle 730.603	04.86-02.01	478 407	324 / 30	
711 D	4,0	77		02.92-02.01			GIR 468 350 21,5 29 835
			Front axle 730.602	02.92-02.01	478 406	304 / 30	
			Front axle 730.603	02.92-02.01	478 407	324 / 30	
		85		04.86-02.01			GIR 468 350 21,5 29 835
			Front axle 730.602	04.86-02.01	478 406	304 / 30	
			Front axle 730.603	04.86-02.01	478 407	324 / 30	
714 D	4,0	103		06.94-02.01			GIR 468 350 21,5 29 835
			Front axle 730.602	06.94-02.01	478 406	304 / 30	
			Front axle 730.603	06.94-02.01	478 407	324 / 30	
8t 809 D	4,0	63		02.92-02.01	478 407	324 / 30	
		66		04.86-02.01	478 407	324 / 30	GIR 468 350 21,5 29 835
811 D	4,0	77		02.92-02.01	478 407	324 / 30	
		85		04.86-02.01	478 407	324 / 30	GIR 468 350 21,5 29 835
814 D	4,0	100		11.87-02.01	478 407	324 / 30	GIR 468 350 21,5 29 835

MITSUBISHI

Colt L300 2.5 D	2,5	53		01.90→ 09.05→	478 358	255,5 / 20	
							SUM 465 111 20 511
L 200 [K0/K1/K2/K3]	1,6	48		11.86-03.95	478 706	258 / 22	SUM 460 978 16,5 21 373
1.6							
2.0 2WD	2,0	65		11.86-05.95	478 706	258 / 22	SUM 460 978 16,5 21 373
2.0 4WD	2,0	65		11.86-05.94	478 635	277 / 22	SUM 460 978 16,5 21 373
2.4 i 2WD	2,4	82		06.90-11.97	478 706	258 / 22	SUM 460 978 16,5 21 373
2.4 i 4WD	2,4	82		06.94-11.97	478 635	277 / 22	SUM 460 978 16,5 21 373
2.5 D Turbo 4WD	2,5	73		11.92-03.01	478 635	277 / 22	SUM 460 978 16,5 21 373
2.5 D 2WD	2,5	54		10.84-05.96	478 706	258 / 22	SUM 460 978 16,5 21 373
2.5 D 4WD	2,5	54		12.87-10.92	478 635	277 / 22	SUM 460 978 16,5 21 373
2.6	2,6	76		11.89-05.95	478 635	277 / 22	SUM 460 978 16,5 21 373

				0 986...		0 986...			1 987...		1 987...	
◀ MITSUBISHI												
Lancer Van 1.8 D	1,8	45		06.88-09.89	478 253	243 / 12,7	SUM	491 260	15	21 126		
				10.89-09.92	478 282	234 / 13						
1.8 D 4WD	1,8	45		06.88-09.89	478 254	242 / 18						
				10.89-09.92	478 277	236 / 18						
Mirage Van 1.5	1,5	54		01.85-09.89	478 253	243 / 12,7	SUM	491 260	15	21 126		
				10.89-10.89	478 282	234 / 13						
Pajero Van	2,5	63		04.86-07.93			SUM	460 978	16,5	21 373		
2.5 D Turbo 4WD		69		09.88-04.91	478 271	258 / 22	SUM	460 978	16,5	21 373		
		77		01.91-07.93	478 635	277 / 22	SUM	460 978	16,5	21 373		
2.8 D Turbo 4WD	2,8	92		07.93-09.99	478 844	276 / 24	AKE	424 523	16	21 363		

NISSAN

Cabstar [F22] 2.0	2,0	74		10.86-06.92			SUM	424 261				
2.5 D	2,5	57		01.85-06.92			SUM	424 261				
[F24] 2.5 D Turbo	2,5	96		09.06→ 4T5	479 355	290 / 26						
3.0 D Turbo	3,0	110		09.06→ 4T5	479 355	290 / 26						
3.2 D	3,2	74		07.99-04.01			AKE	424 715	16,5	23 420		
Datsun Truck 2.0 4WD	2,0	67		08.86-09.89			AKE	490 990	17	21 119		
E20 1.8	1,8	61		05.81-12.95			SUM	468 630	17,1	20 863		
2.0	2,0			05.81-12.96			SUM	468 630	17,1	20 863		
Hardbody [NP300]	2,5	98		01.06→	479 031	300 / 28	AKE	494 152		23970		
2.5 D Turbo 4x4												
Interstar [X70]	1,9	59-60		07.02→	479 001	305,5 / 28						
1.9 D Turbo dCi 80												
2.2 D Turbo dCi 90	2,2	66		07.02→	479 001	305,5 / 28						
2.5 D Turbo dCi 100	2,5	73-74		11.03→	479 001	305,5 / 28						
2.5 D Turbo dCi 120	2,5	84-88		07.02→	479 001	305,5 / 28						
3.0 D Turbo dCi 140	3,0	99-100		11.03→	479 001	305,5 / 28						
Kubistar [X76] 1.2 i 8V	1,1	44		07.03→ NOR			BSY	424 487	17,3	21 980		
1.2 i 16V	1,1	55-56		07.03→ NOR			BSY	424 487	17,3	21 980		
1.4 i	1,4	55		07.03→ NOR			BSY	424 487	17,3	21 980		
1.5 D Turbo 60	1,5	40-42		07.03→ NOR			BSY	424 487	17,3	21 980		
1.5 D Turbo 70	1,5	48-50		07.03→ NOR			BSY	424 487	17,3	21 980		
1.5 D Turbo 80	1,5	59-62		07.03→ NOR			BSY	424 487	17,3	21 980		
1.6 i	1,6	70-71		07.03→ NOR			BSY	424 487	17,3	21 980		
Navara [D40] 2.5 dCi	2,5	106		05.05→ B17	479 357	320 / 28	SUM	494 151		24227		
				16Z	479 356	295,5 / 28	SUM	494 151		24227		
2.5 dCi 4x4	2,5	126-128		05.05→ B17	479 357	320 / 28	SUM	494 151		24227		
				16Z	479 356	295,5 / 28	SUM	494 151		24227		
Pickup [D21] 1.6	1,6			09.85-07.92	478 709	250 / 22	AKE	490 990	17	21 119		
2.0	2,0	64/65/ 66		09.85-09.95	478 709	250 / 22	AKE	490 990	17	21 119		
2.3 D	2,3	51		09.85-08.87	478 709	250 / 22	AKE	490 990	17	21 119		
2.4	2,4	74		09.85-04.92	478 806	267 / 22	AKE	490 990	17	21 119		
2.4 i	2,4	91-93		04.92-02.98			AKE	490 990	17	21 119		
2.4 i 4WD	2,4	74		08.88-04.92	478 806	267 / 22	AKE	490 990	17	21 119		
		91-93		04.92-02.98	478 532	277 / 26	AKE	490 990	17	21 119		
2.4 4WD	2,4	74		09.85-04.92	478 806	267 / 22	AKE	490 990	17	21 119		
2.5 D	2,5	53/57 59-63		09.85-08.87	478 806	267 / 22	AKE	490 990	17	21 119		
				08.87-02.98	478 709	250 / 22	AKE	490 990	17	21 119		
2.5 D 2WD	2,5	55		09.85-07.87	478 709	250 / 22	AKE	490 990	17	21 119		
2.5 D 4WD	2,5	53		09.85-08.87	478 806	267 / 22	AKE	490 990	17	21 119		
		55		08.87-02.92	478 709	250 / 22	AKE	490 990	17	21 119		
					478 806	267 / 22						
		57		09.85-08.87	478 806	267 / 22	AKE	490 990	17	21 119		
		59-63		08.87-02.98	478 806	267 / 22	AKE	490 990	17	21 119		
2.7 D	2,7	73		08.87-01.97	478 709	250 / 22	AKE	490 990	17	21 119		
2.7 D 4WD	2,7	73		08.87-01.97	478 806	267 / 22	AKE	490 990	17	21 119		
[D22] 2.4 i	2,4	88		02.98-11.01			AKE	493 480	17	21 348		
				DOP	478 532	277 / 26						
2.4 i 4WD	2,4	88		02.98-11.01	478 532	277 / 26	AKE	493 480	17	21 348		

				0 986...	0 986...	1 987...	1 987...
Pickup [D22]	2,4	93	02.97→	478 532	277 / 26		
2.4 i 4WD		98	11.01-01.08	479 031	300 / 28	AKE 494 152	23970
2.5 D	2,5	61	02.98-11.01			AKE 493 480	17 21 348
			DOP	478 532	277 / 26		
2.5 D Turbo	2,5	98	11.01-01.08	SA 479 031	300 / 28	AKE 494 152	23970
2.5 D Turbo 4WD	2,5	76	05.98-11.01	478 532	277 / 26	AKE 493 480	17 21 348
		98	11.01-01.08	479 031	300 / 28	AKE 494 152	23970
2.5 D 4WD	2,5	61	02.98-11.01			AKE 493 480	17 21 348
			DOP	478 532	277 / 26		
2.5 dCi 4x4	2,5	98	02.08→	479 031	300 / 28	AKE 494 152	23970
2.7 D 2WD	2,7	64	02.97→	478 709	250 / 22	AKE 490 990	17 21 119
3.2 D 4WD	3,2		02.97→	478 532	277 / 26		
[720] 1.6	1,6		01.83-09.85			AKE 490 990	17 21 119
1.8	1,8		01.83-09.85			AKE 490 990	17 21 119
2.2 4WD	2,2	71	04.83-09.85	478 806	267 / 22	AKE 490 990	17 21 119
2.3 D	2,3		01.83-09.85			AKE 490 990	17 21 119
2.5 D	2,5	53	04.83-09.85	LLE 478 806	267 / 22	AKE 490 990	17 21 119
Primastar [X83]	1,9	59-60	07.02→			GIR 424 636	18,4 23 099
1.9 dCi 80							
1.9 dCi 100	1,9	74	07.02→			GIR 424 636	18,4 23 099
2.0 dCi 90	2,0	66	09.06→			GIR 424 636	18,4 23 099
2.0 dCi 120	2,0	84-85	09.06→			GIR 424 636	18,4 23 099
2.0 i	2,0	88	02.03→			GIR 424 636	18,4 23 099
2.5 dCi 140	2,5	99	09.03→			GIR 424 636	18,4 23 099
2.5 dCi 150	2,5	107-110	09.06→			GIR 424 636	18,4 23 099
Serena Van 2.0 D	2,0	56	06.91-06.99	478 361	250 / 22		
Terrano 2.7 D 4WD	2,7	63	08.86-01.93	478 806	267 / 22		
Trade 2.8 D	2,8	57-60	03.87-12.98			BSY 424 080	17 20 706
Urvan [E23] 1.8	1,8		04.82-01.87			SUM 468 630	17,1 20 863
2.0	2,0	55	07.80-04.82			SUM 468 320	20 832
		64	04.82-01.87			SUM 468 630	17,1 20 863
		64-66	04.82-02.87			SUM 468 320	20 832
2.2 D	2,2	47-48	07.80-04.82			SUM 468 320	20 832
2.3 D	2,3	51	04.82-01.87			SUM 468 630	17,1 20 863
			04.82-02.87			SUM 468 320	20 832
[E24] 2.0	2,0	64	11.86-05.89			AKE 490 990	17 21 119
			06.89-01.95			AKE 493 480	17 21 348
		64-66	02.87-07.94			AKE 493 480	17 21 348
2.3 D	2,3	53	02.87-12.88			AKE 493 480	17 21 348
		55	11.86-03.89			AKE 490 990	17 21 119
2.4	2,4	74	11.86-05.89			AKE 490 990	17 21 119
			06.89-06.97			AKE 493 480	17 21 348
2.4 i	2,4	74-76	05.89-11.95			AKE 493 480	17 21 348
2.5 D	2,5	59	12.88-05.97			AKE 493 480	17 21 348
		63	03.89-05.89			AKE 490 990	17 21 119
			06.89-06.97			AKE 493 480	17 21 348
Vanette [C120] 1.5	1,5	51	02.83-06.87	478 260	250 / 18		
2.0 D	2,0	48-49	02.83-06.87	478 260	250 / 18		
[C220] 2.0 D	2,0	44	04.87-11.94	478 458	250 / 22	AKE 490 990	17 21 119
		47-49	12.87-11.94	478 458	250 / 22	AKE 490 990	17 21 119
[GC22] 1.5	1,5	51	09.86-03.93			AKE 493 480	17 21 348
			09.86-12.96	478 484	260 / 26		
			07.87-03.93	LWG		AKE 490 990	17 21 119
2.0	2,0	64	09.86-06.87			SUM 461 133	19 20 098
			09.86-03.93	478 484	260 / 26		
			09.86-04.93	478 484	260 / 26		
			06.87-03.93			AKE 493 480	17 21 348
		66	05.86-12.86			AKE 490 990	17 21 119
			04.88-04.93			AKE 490 990	17 21 119
2.0 D	2,0	47-49	09.86-06.87	478 484	260 / 26	SUM 461 133	19 20 098
			06.87-03.93	478 484	260 / 26	AKE 493 480	17 21 348
			07.87-03.93	LWG		AKE 490 990	17 21 119



				0 986...		0 986...		1 987...		1 987...	
◀NISSAN											
Vanette [GC22]	2.4	74		06.86-12.86		AKE	490 990	17	21 119		
				04.88-10.91		AKE	490 990	17	21 119		
i	2,4	74-77		09.86-06.87	🔧	478 484	260 / 26	SUM	461 133	19	20 098
				06.87-03.93	🔧	478 484	260 / 26	AKE	493 480	17	21 348
Vanette Cargo [C23M]	1,6	71-72		07.92-11.01	EIZ	478 685	250 / 22	AKE	490 990	17	21 119
1.6i					ZWZ	478 485	256,5 / 26		424 204	15,5	21 481
2.0D	2,0	49		07.92-09.94	EIZ	478 685	250 / 22	AKE	490 990	17	21 119
					ZWZ	478 485	256,5 / 26		424 204	15,5	21 481
2.3D	2,3	55		09.94-11.01	EIZ	478 685	250 / 22	AKE	490 990	17	21 119
					ZWZ	478 485	256,5 / 26		424 204	15,5	21 481

OPEL

Arena	1,9	44		03.98-08.01	🔧	478 113	252,5 / 24	BSY	460 946	18,5	20 926
2.5D	2,5	55		03.98-08.01	🔧	478 113	252,5 / 24	BSY	460 946	18,5	20 926
Campo Pick-Up [TF0]	2,2	39-45		08.87-09.96	🔧	478 596	257,5 / 22,1	AKE	460 960		474 257
2.2D											
2.3	2,3	65-72		09.91-09.96	🔧	478 596	257,5 / 22,1	AKE	460 960		474 257
2.5D/TD	2,5	56		02.89-08.97	🔧	478 596	257,5 / 22,1	AKE	460 960		474 257
3.1TD	3,1	80		03.95-08.97	🔧	478 596	257,5 / 22,1	AKE	460 960		474 257
[TF1] 2.5DI	2,5	56		03.97-08.01	🔧	478 596	257,5 / 22,1	AKE	460 960		474 257
2.5DTI	2,5	74		08.01-08.03	🔧	478 596	257,5 / 22,1	AKE	460 960		474 257
3.1TDS	3,1	80		03.97-08.02	🔧	478 596	257,5 / 22,1	AKE	460 960		474 257
Combo 1.2i	1,2	33		09.94-10.01	🔧	478 192	236 / 20	ATE	460 938		474 179
1.4i	1,4	44/60		09.94-10.01	🔧	478 192	236 / 20	ATE	460 938		474 179
		66		08.99-10.01	🔧	478 192	236 / 20	ATE	460 938		474 179
1.7D	1,7	44		09.94-10.01	🔧	478 192	236 / 20	ATE	460 938		474 179
[Tour] 1.3 CDTI	1,3	51	Fg.no. →4303389	09.04-09.07	🔧	478 730	260,5 / 24	GIR	424 527	17	23 225
			Fg.no. 53000001→	09.04-09.07	🔧	478 730	260,5 / 24	ATE	424 707		23 832
		55	Fg.no. →4303389	10.05→	🔧	478 730	260,5 / 24	GIR	424 527	17	23 225
			Fg.no. 53000001→	10.05→	🔧	478 730	260,5 / 24	ATE	424 707		23 832
1.4i Twinport	1,4	66	Fg.no. →4303389	09.04→	🔧	478 730	260,5 / 24	GIR	424 527	17	23 225
			Fg.no. 53000001→	09.04→	🔧	478 730	260,5 / 24	ATE	424 707		23 832
1.6 CNG	1,6	69-71		04.05→				ATE	424 707		23 832
								GIR	424 527	17	23 225
					TW	478 730	260,5 / 24				
						479 077	280 / 25				
1.6i	1,6	64		10.01-08.04				GIR	424 527	17	23 225
					TW	478 730	260,5 / 24				
						479 077	280 / 25				
				09.03-08.04				ATE	424 707		23 832
1.7 CDTI	1,7	74		09.04→	🔧	478 883	280 / 25	ATE	424 707		23 832
1.7DI	1,7	48		10.01-08.04	🔧	478 730	260,5 / 24	GIR	424 527	17	23 225
				09.03-08.04				ATE	424 707		23 832
1.7DTI	1,7	55		10.01-08.04	🔧	478 730	260,5 / 24	GIR	424 527	17	23 225
				09.03-08.04				ATE	424 707		23 832
Euromidi 2.0	2,0	74		09.88-08.96	AA,MC1	478 658	250 / 18				
			Fg.no. →KV637435	09.88-08.96	MC1			SUM	424 157		21 115
2.0DT	2,0	51		09.88-08.96	AA,MC1	478 658	250 / 18				
			Fg.no. →KV637435	09.88-08.96	MC1			SUM	424 157		21 115
2.2D	2,2	45		09.88-08.96	MC2,MC3	478 658	250 / 18				
			Fg.no. →KV637435	09.88-08.96	MC1			SUM	424 157		21 115
2.4DT	2,4	56		09.88-08.96	MC2,MC3	478 658	250 / 18				
			Fg.no. →KV637435	09.88-08.96	MC1			SUM	424 157		21 115
Movano 1.9D	1,9	59		01.99-10.01	15Z	478 745	280 / 24	BSY	424 480	17,8	23 302
					16Z	479 001	305,5 / 28		494 031	17,8	23 613

				0 986...	0 986...	1 987...	1 987...
Movano 1.9 DTI	1,9	60	10.01-10.05	15Z	▮ 478 745 280 / 24	BSY 424 480	17,8 23 302
				16Z	▮ 479 001 305,5 / 28	494 031	17,8 23 613
2.2 DTI	2,2	66	09.00-10.05	15Z	▮ 478 745 280 / 24	BSY 424 480	17,8 23 302
				16Z	▮ 479 001 305,5 / 28	494 031	17,8 23 613
2.5 D	2,5	59	10.98-09.01	15Z	▮ 478 745 280 / 24	BSY 424 480	17,8 23 302
				16Z	▮ 479 001 305,5 / 28	494 031	17,8 23 613
2.5 DTI	2,5	73/74/ 84	10.01-12.04	16Z,WW		494 031	17,8 23 613
			10.01→	15Z	▮ 478 745 280 / 24	BSY 424 480	17,8 23 302
				16Z	▮ 479 001 305,5 / 28	494 031	17,8 23 613
		88/107	08.06→	15Z	▮ 478 745 280 / 24	BSY 424 480	17,8 23 302
				16Z	▮ 479 001 305,5 / 28	494 031	17,8 23 613
2.8 DTI	2,8	84	06.98-09.02	15Z	▮ 478 745 280 / 24	BSY 424 480	17,8 23 302
				16Z	▮ 479 001 305,5 / 28	494 031	17,8 23 613
3.0 CDTI	3,0	100	03.03-10.05	15Z	▮ 478 745 280 / 24	BSY 424 480	17,8 23 302
				16Z	▮ 479 001 305,5 / 28	494 031	17,8 23 613
Vivaro 1.9 CDTI	1,9	60	03.01-08.06		▮ 479 078 305,5 / 28		
		Fg.no. →6V699999 →6Y999999	03.01-08.06			GIR 424 636	18,4 23 099
1.9 DTI	1,9	74	03.01-08.06		▮ 479 078 305,5 / 28		
		Fg.no. →6V699999 →6Y999999	03.01-08.06			GIR 424 636	18,4 23 099
2.0 CDTI	2,0	66/84	08.06→		▮ 479 078 305,5 / 28		
		Fg.no. →6V699999 →6Y999999	08.06→			GIR 424 636	18,4 23 099
2.0 16V	2,0	86-88	03.01→		▮ 479 078 305,5 / 28		
		Fg.no. →6V699999 →6Y999999	03.01→			GIR 424 636	18,4 23 099
2.5 CDTI	2,5	84	08.06-06.08		▮ 479 078 305,5 / 28		
		Fg.no. →6V699999 →6Y999999	08.06-06.08			GIR 424 636	18,4 23 099
		99	09.02-08.06		▮ 479 078 305,5 / 28		
		Fg.no. →6V699999 →6Y999999	09.02-08.06			GIR 424 636	18,4 23 099
		107	08.06→		▮ 479 078 305,5 / 28		
		Fg.no. →6V699999 →6Y999999	08.06→			GIR 424 636	18,4 23 099
PEUGEOT							
Bipper [A9] 1.4 HdI	1,4	50	02.08→	GS		BSY 494 113	18 23982
1.4 i	1,4	54	02.08→			BSY 494 113	18 23982
Boxer 2.8 D	2,8	66	03.02-08.05	L02		BRB 424 769	19,1 23 919
				L02		GIR 424 031	19,6 21 800
				L03		GIR 424 030	19,5 21 797
				L03		494 048	18,3 23 917
					▮ 479 297 280 / 24		
					▮ 478 843 279,5 / 18		
2.8 D Interc.	2,8	90	03.02-08.05	L02		BRB 424 769	19,1 23 919
				L02		GIR 424 031	19,6 21 800
				L03		GIR 424 030	19,5 21 797
				L03		494 048	18,3 23 917
					▮ 479 297 280 / 24		
					▮ 478 843 279,5 / 18		
2.8 D Turbo	2,8	77	01.02-08.05	L02		BRB 424 769	19,1 23 919
				L02		GIR 424 031	19,6 21 800
				L03		GIR 424 030	19,5 21 797
				L03		494 048	18,3 23 917
					▮ 479 297 280 / 24		
					▮ 478 843 279,5 / 18		



				0 986...	0 986...	1 987...	1 987...
◀ PEUGEOT							
Boxer 2.8 HDI2,8	93	09.05→	L02	BRB	424 769	19,1	23 919
			L02	GIR	424 031	19,6	21 800
			L03	GIR	424 030	19,5	21 797
			L03		494 048	18,3	23 917
				479 297	280 / 24		
				478 843	279,5 / 18		
[U3] 1.9 D	1,9 50		07.98-02.02	L02	478 842	300 / 24	GIR 424 031 19,6 21 800
				L03	478 434	280 / 24	GIR 424 030 19,5 21 797
					478 843	279,5 / 18	
	51		02.94-02.02	L02	478 842	300 / 24	GIR 424 031 19,6 21 800
				L03	478 434	280 / 24	GIR 424 030 19,5 21 797
					478 843	279,5 / 18	
1.9 D Turbo	1,9 66/68		02.94-02.02	L02	478 842	300 / 24	GIR 424 031 19,6 21 800
				L03	478 434	280 / 24	GIR 424 030 19,5 21 797
					478 843	279,5 / 18	
2.0	2,0 79		02.94-02.02	L02	478 842	300 / 24	GIR 424 031 19,6 21 800
				L03	478 434	280 / 24	GIR 424 030 19,5 21 797
					478 843	279,5 / 18	
2.0 HDi	2,0 62		09.01-02.02	L02	478 842	300 / 24	GIR 424 031 19,6 21 800
				L03	478 434	280 / 24	GIR 424 030 19,5 21 797
					478 843	279,5 / 18	
2.0 i	2,0 80		02.94-02.02	L02	478 842	300 / 24	GIR 424 031 19,6 21 800
				L03	478 434	280 / 24	GIR 424 030 19,5 21 797
					478 843	279,5 / 18	
2.5 D	2,5 62		01.99-02.02	L02	478 842	300 / 24	GIR 424 031 19,6 21 800
				L03	478 434	280 / 24	GIR 424 030 19,5 21 797
					478 843	279,5 / 18	
	63		02.94-02.02	L02	478 842	300 / 24	GIR 424 031 19,6 21 800
				L03	478 434	280 / 24	GIR 424 030 19,5 21 797
					478 843	279,5 / 18	
2.5 D Turbo	2,5 76		02.94-02.02	L02	478 842	300 / 24	GIR 424 031 19,6 21 800
				L03	478 434	280 / 24	GIR 424 030 19,5 21 797
					478 843	279,5 / 18	
2.5 TDi	2,5 79		10.96-02.02	L02	478 842	300 / 24	GIR 424 031 19,6 21 800
				L03	478 434	280 / 24	GIR 424 030 19,5 21 797
					478 843	279,5 / 18	
2.8 D	2,8 64		01.99-02.02	L02	478 842	300 / 24	GIR 424 031 19,6 21 800
				L03	478 434	280 / 24	GIR 424 030 19,5 21 797
					478 843	279,5 / 18	
2.8 D Turbo	2,8 90		10.99-02.02	L02	478 842	300 / 24	GIR 424 031 19,6 21 800
				L03	478 434	280 / 24	GIR 424 030 19,5 21 797
					478 843	279,5 / 18	
2.8 HDi	2,8 94		09.00-02.02	L02	478 842	300 / 24	GIR 424 031 19,6 21 800
				L03	478 434	280 / 24	GIR 424 030 19,5 21 797
					478 843	279,5 / 18	
[U5] 2.0 HDi	2,0 62		02.02→	L02	478 842	300 / 24	BRB 424 769 19,1 23 919
				L03	478 434	280 / 24	494 048 18,3 23 917
2.0 i	2,0 80		02.02→	L02	478 842	300 / 24	BRB 424 769 19,1 23 919
				L03	478 434	280 / 24	494 048 18,3 23 917
2.2 HDi	2,2 74		02.02→	L02	478 842	300 / 24	BRB 424 769 19,1 23 919
				L03	478 434	280 / 24	494 048 18,3 23 917
2.8 D Turbo	2,8 90		02.02→	L02	478 842	300 / 24	BRB 424 769 19,1 23 919
				L03	478 434	280 / 24	494 048 18,3 23 917
2.8 HDi	2,8 94		02.02→	L02	478 842	300 / 24	BRB 424 769 19,1 23 919
				L03	478 434	280 / 24	494 048 18,3 23 917
	107		08.04→	L02	478 842	300 / 24	BRB 424 769 19,1 23 919
				L03	478 434	280 / 24	494 048 18,3 23 917
[U9] 2.2 HDi	2,2 74/88		06.06→		479 313	280 / 28	BRB 494 111 19,1 24468
					479 297	280 / 24	BRB 494 111 19,1 24468
					479 314	300 / 24	BRB 494 109 19 24466
					479 315	300 / 32	BRB 494 109 19 24466



				0 986...	0 986...			1 987...	1 987...
Boxer [U9]	3.0 HDi	3,0 115	06.06→	▮ 479 313	280 / 28	BRB	494 111	19,1 24468	
				▮ 479 297	280 / 24	BRB	494 111	19,1 24468	
				▮ 479 314	300 / 24	BRB	494 109	19 24466	
				▮ 479 315	300 / 32	BRB	494 109	19 24466	
Expert [G9]	1.6 HDi	1,6 66	02.07→	HTB ▮ 479 266	280 / 28	GIR	494 163	18,3 24608	
				SBR ▮ 479 380	304 / 28	GIR	494 163	18,3 24608	
	2.0 HDi	2,0 88/100	02.07→	▮ 479 380	304 / 28	GIR	494 163	18,3 24608	
	2.0 i16V	2,0 103	02.07→	▮ 479 380	304 / 28	GIR	494 163	18,3 24608	
	[U64] 1.6 i	1,6 58	09.95→	BSY ▮ 478 896	257,5 / 20	BSY	424 415	18,5 23 042	474 199
				GIR ▮ 478 812	280,6 / 26	GIR	424 033	19,3 21 801	
	1.8 i	1,8 70	09.96→	BSY ▮ 478 896	257,5 / 20	BSY	424 415	18,5 23 042	474 199
				GIR ▮ 478 812	280,6 / 26	GIR	424 033	19,3 21 801	
	1.9 D	1,9 51	09.95→	BSY ▮ 478 896	257,5 / 20	BSY	424 415	18,5 23 042	474 199
				GIR ▮ 478 812	280,6 / 26	GIR	424 033	19,3 21 801	
		52	09.01→	BSY ▮ 478 896	257,5 / 20	BSY	424 415	18,5 23 042	474 199
				GIR ▮ 478 812	280,6 / 26	GIR	424 033	19,3 21 801	
	1.9 D Turbo	1,9 66-68	09.95→	BSY ▮ 478 896	257,5 / 20	BSY	424 415	18,5 23 042	474 199
				GIR ▮ 478 812	280,6 / 26	GIR	424 033	19,3 21 801	
	2.0 HDi	2,0 70/80	10.99→	BSY ▮ 478 896	257,5 / 20	BSY	424 415	18,5 23 042	474 199
				GIR ▮ 478 812	280,6 / 26	GIR	424 033	19,3 21 801	
						GIR,	424 789	19,3 20 261	
				LUC ▮ 479 114	285 / 28	GIR,	424 789	19,3 20 261	
		81	06.00→	BSY ▮ 478 896	257,5 / 20	BSY	424 415	18,5 23 042	474 199
				GIR ▮ 478 812	280,6 / 26	GIR	424 033	19,3 21 801	
						GIR,	424 789	19,3 20 261	
				LUC ▮ 479 114	285 / 28	GIR,	424 789	19,3 20 261	
						LUC			
	2.0 i16V	2,0 100	03.00→	BSY ▮ 478 896	257,5 / 20	BSY	424 415	18,5 23 042	474 199
				GIR ▮ 478 812	280,6 / 26	GIR	424 033	19,3 21 801	
						GIR,	424 789	19,3 20 261	
				LUC ▮ 479 114	285 / 28	GIR,	424 789	19,3 20 261	
						LUC			
J5	1.8	1,8 49-51	09.81-12.93	L02 ▮ 478 234	290 / 16	GIR	467 411	19 20 741	
			Fg.no. →S 154461	09.81-12.93	L03 ▮ 478 067	257 / 12	GIR	467 411	19 20 741
			Fg.no. S 154462→	09.81-12.93	L03 ▮ 478 200	255 / 16	GIR	467 411	19 20 741
	1.9 D	1,9 51	11.87-12.93	L02 ▮ 478 234	290 / 16	GIR	467 411	19 20 741	
			Fg.no. →S 154461	11.87-12.93	L03 ▮ 478 067	257 / 12	GIR	467 411	19 20 741
			Fg.no. S 154462→	11.87-12.93	L03 ▮ 478 200	255 / 16	GIR	467 411	19 20 741
	1.9 D Turbo	1,9 60	08.92-12.93		▮ 478 234	290 / 16	GIR	460 998	19,5 21 205
	2.0	2,0 55-63	09.81-12.93	L02 ▮ 478 234	290 / 16	GIR	467 411	19 20 741	
			Fg.no. →S 154461	09.81-12.93	L03 ▮ 478 067	257 / 12	GIR	467 411	19 20 741
			Fg.no. S 154462→	09.81-12.93	L03 ▮ 478 200	255 / 16	GIR	467 411	19 20 741
		62/72	07.87-12.93	L02 ▮ 478 234	290 / 16	GIR	467 411	19 20 741	
	2.5 D	2,5 54-55	09.81-12.93	L02 ▮ 478 234	290 / 16	GIR	467 411	19 20 741	
			Fg.no. →S 154461	09.81-12.93	L03 ▮ 478 067	257 / 12	GIR	467 411	19 20 741
			Fg.no. S 154462→	09.81-12.93	L03 ▮ 478 200	255 / 16	GIR	467 411	19 20 741
	2.5 D Turbo	2,5 70	07.87-12.93		▮ 478 234	290 / 16	GIR	460 998	19,5 21 205
J9	1.6	1,6 43	10.80-09.85		▮ 478 770	280 / 14	BSY	424 045	20 367
			10.85-06.87		▮ 478 770	280 / 14	BSY	424 046	20 366
	2.0	2,0 55	10.80-09.85		▮ 478 770	280 / 14	BSY	424 045	20 367
			10.85-06.87		▮ 478 770	280 / 14	BSY	424 046	20 366
	2.1 D	2,1 41	10.80-09.85		▮ 478 770	280 / 14	BSY	424 045	20 367
			10.85-06.87		▮ 478 770	280 / 14	BSY	424 046	20 366
	2.3 D	2,3 49	10.80-10.82		▮ 478 770	280 / 14	BSY	424 045	20 367
	2.5 D	2,5 53	07.82-09.85		▮ 478 770	280 / 14	BSY	424 045	20 367
			10.85-06.87		▮ 478 770	280 / 14	BSY	424 046	20 366



				0 986...	0 986...		1 987...	1 987...
◀ PEUGEOT								
Partner 1.8 i	1,8	66	10.99-12.03 BO	478 618	266 / 22	GIR	424 414	19 23 124
				478 268	265,8 / 20,5			
				478 847	266 / 13			
[B9] 1.6 HDi	1,6	55/66/80	05.08→	478 979	283 / 26			
i 16V	1,6	66/80	05.08→	478 979	283 / 26			
[M4] Electrique		24	01.98-08.02 BO	478 618	266 / 22	BSY	494 027	19 23 599
			GIR	478 268	265,8 / 20,5	GIR	424 414	19 23 124
				478 847	266 / 13			
1.1 i	1,1	44	07.96-08.02			BSY	494 027	19 23 599
						GIR	424 414	19 23 124
			BO	478 618	266 / 22			
			GIR	478 268	265,8 / 20,5			
				478 847	266 / 13			
1.4	1,4	51-52	11.96-08.02			BSY	494 027	19 23 599
						GIR	424 414	19 23 124
			BO	478 618	266 / 22			
			GIR	478 268	265,8 / 20,5			
				478 847	266 / 13			
1.4 i	1,4	55	07.96-08.02			BSY	494 027	19 23 599
						GIR	424 414	19 23 124
			BO	478 618	266 / 22			
			GIR	478 268	265,8 / 20,5			
				478 847	266 / 13			
1.6 i 16V	1,6	80	09.00-08.02 BO	478 618	266 / 22	BSY	494 027	19 23 599
			GIR	478 268	265,8 / 20,5	GIR	424 414	19 23 124
				478 847	266 / 13			
1.8 D	1,8	43-44	07.96-08.02			BSY	494 027	19 23 599
						GIR	424 414	19 23 124
			BO	478 618	266 / 22			
			GIR	478 268	265,8 / 20,5			
				478 847	266 / 13			
1.8 i	1,8	66	03.97-08.02 BO	478 618	266 / 22	BSY	494 027	19 23 599
			GIR	478 268	265,8 / 20,5	GIR	424 414	19 23 124
				478 847	266 / 13			
1.9 D	1,9	50	07.96-08.02			BSY	494 027	19 23 599
						GIR	424 414	19 23 124
			BO	478 618	266 / 22			
			GIR	478 268	265,8 / 20,5			
				478 847	266 / 13			
		51	07.96-08.02			BSY	494 027	19 23 599
						GIR	424 414	19 23 124
			BO	478 618	266 / 22			
			GIR	478 268	265,8 / 20,5			
				478 847	266 / 13			
		52	09.00-08.02 BO	478 618	266 / 22	BSY	494 027	19 23 599
			GIR	478 268	265,8 / 20,5	GIR	424 414	19 23 124
				478 847	266 / 13			
2.0 HDi	2,0	66	12.99-08.02			BSY	494 027	19 23 599
						GIR	424 414	19 23 124
			BO	478 618	266 / 22			
			GIR	478 268	265,8 / 20,5			
				478 847	266 / 13			
[M5] 1.1 i	1,1	44	09.02→	478 618	266 / 22	BSY	494 027	19 23 599



				0 986...	0 986...				1 987...	1 987...	
Partner [M5] 1.4 i	1,4	55	09.02→	▮ 478 618	266 / 22	BSY	494 027	19	23 599		
1.6 HDi	1,6	55	09.05→	▮ 478 618	266 / 22	BSY	494 027	19	23 599		
		66	09.05→	MFD	▮ 478 979	283 / 26	BSY	494 038	19	23 600	
				OFD	▮ 478 618	266 / 22	BSY	494 027	19	23 599	
1.6 i 16V	1,6	80	09.02→	MFD	▮ 478 979	283 / 26	BSY	424 529	17,8	23 396	
				OFD	▮ 478 618	266 / 22	BSY	494 027	19	23 599	
1.9 D	1,9	52	09.02→		▮ 478 618	266 / 22	BSY	494 027	19	23 599	
2.0 HDi	2,0	66	09.02→	MFD	▮ 478 979	283 / 26	BSY	494 038	19	23 600	
				OFD	▮ 478 618	266 / 22	BSY	494 027	19	23 599	
Ranch [M4] 1.4 i	1,4	55	07.97→			BSY	494 027	19	23 599		
						GIR	424 414	19	23 124		
				BO	▮ 478 618	266 / 22					
				GIR	▮ 478 268	265,8 / 20,5					
					▮ 478 847	266 / 13					
1.9 D	1,9	51	07.97→			BSY	494 027	19	23 599		
						GIR	424 414	19	23 124		
				BO	▮ 478 618	266 / 22					
				GIR	▮ 478 268	265,8 / 20,5					
					▮ 478 847	266 / 13					
205 Pickup 1.1	1,1	40	10.87-12.90							474 038	
										474 241	
						ATE	424 410	16	21 827		
				BKV		BSY	469 860	17,8	20 986	474 078	
						GIR	490 800	17,6	21 080		
					▮ 478 046	247,5 / 10					
1.8 D	1,8	44	05.85-09.98							474 038	
										474 241	
						ATE	424 410	16	21 827		
				BKV		BSY	469 860	17,8	20 986	474 078	
						GIR	490 800	17,6	21 080		
					▮ 478 046	247,5 / 10					
504 Pickup 1.8	1,8	50/53	Fg.no. 3610001→	07.84-12.89	SAZ	▮ 478 091	273 / 12,7				
2.1 D	2,1	48	Fg.no. 3610001→	08.81-12.90	SAZ	▮ 478 091	273 / 12,7				
2.3 D	2,3	51	Fg.no. 3610001→	07.84-12.89	SAZ	▮ 478 091	273 / 12,7				
2.5 D	2,5	55	Fg.no. 3610001→	07.87-12.89	SAZ	▮ 478 091	273 / 12,7				
RENAULT											
Clio I [X57] 1.2 i	1,2	40-41	06.90-02.98		▮ 478 105	238 / 12	BSY	469 860	17,8	20 986	474 135
							GIR	467 720	18	21 463	474 135
		44	01.94-03.96				BSY	469 860	17,8	20 986	474 135
							GIR	467 720	18	21 463	
1.4	1,4	55-57	01.94-03.96		▮ 478 105	238 / 12	BSY	469 860	17,8	20 986	474 135
							GIR	467 720	18	21 463	474 135
Express 1.9 D	1,9	40	07.95-09.02		▮ 478 105	238 / 12					
Express, Extra, Rapid [F40] Electrique	1,0	21	06.96-10.97				BSY				474 135
					▮ 478 105	238 / 12					
					▮ 478 273	238 / 8					
1.0	1,0	27-30	03.86-08.91		▮ 478 105	238 / 12					
					▮ 478 273	238 / 8					
			03.86-05.88				GIR	424 372		21 256	
			Fg.no. →J029302	03.86-05.88			BSY	466 346	14,5	21 096	474 195
			Fg.no. J029303→	06.88-08.91			BSY	469 860	17,8	20 986	474 135
							GIR	467 720	18	21 463	474 135
1.1	1,1	33	06.87-08.91		▮ 478 105	238 / 12					
					▮ 478 273	238 / 8					
			06.87-05.88				GIR	424 372		21 256	
			Fg.no. →E000461 →J002931	06.87-05.88			BSY	466 346	14,5	21 096	474 195



				0 986...	0 986...			1 987...	1 987...		
◀RENAULT											
Express, Extra, Rapid [F40] 1.1	1,1	33	Fg.no. E000462→ J002932→	06.88-08.91		BSY	469 860	17,8	20 986	474 135	
					GIR	467 720	18	21 463	474 135		
		34		Fg.no. →E011000 →J082340 Fg.no. E011001→ J082341→	03.86-08.91	478 105	238 / 12				
					478 273	238 / 8					
	03.86-05.88					GIR	424 372		21 256		
	03.86-08.91					BSY	461 763	17,8	20 986	474 135	
	08.90-08.91					BSY	469 860	17,8	20 986	474 135	
						GIR	467 720	18	21 463	474 135	
						BSY	466 346	14,5	21 096	474 195	
						GIR	467 720	18	21 463	474 135	
	36			09.91-10.97	478 105	238 / 12					
				478 273	238 / 8	BSY	469 860	17,8	20 986	474 135	
						GIR	467 720	18	21 463		
1.2	1,2	40		09.91-09.96	478 105	238 / 12					
				478 273	238 / 8	BSY	469 860	17,8	20 986	474 135	
						GIR	467 720	18	21 463		
1.2i	1,2	40		09.91-10.97	478 105	238 / 12					
				478 273	238 / 8	BSY	469 860	17,8	20 986	474 135	
						GIR	467 720	18	21 463		
1.4	1,4	43/44		03.86-09.97	478 105	238 / 12					
				478 273	238 / 8	BSY	469 860	17,8	20 986	474 135	
						GIR	467 720	18	21 463		
1.4i	1,4	44		03.86-03.97	478 105	238 / 12					
				478 273	238 / 8	BSY	469 860	17,8	20 986	474 135	
						GIR	467 720	18	21 463		
		55-59		09.91-10.97	478 105	238 / 12					
					478 273	238 / 8	BSY	469 860	17,8	20 986	474 135
						GIR	467 720	18	21 463		
1.6D	1,6	40		03.86-03.97	478 105	238 / 12					
				478 273	238 / 8						
				03.86-05.86			GIR	424 372		21 256	
				10.87-03.97			BSY	469 860	17,8	20 986	474 135
						GIR	467 720	18	21 463	474 135	
			Fg.no. →E008444 →J020150	03.86-05.86			BSY	466 346	14,5	21 096	474 195
			Fg.no. E008445→ J020151→	06.86-03.97			BSY	469 860	17,8	20 986	474 135
						GIR	467 720	18	21 463	474 135	
1.9D	1,9	40		09.94-09.97			GIR	467 720	18	21 463	474 135
									BSY	469 860	17,8
					478 105	238 / 12					
					478 273	238 / 8					
		47-48		09.91-10.97			GIR	467 720	18	21 463	474 135
									BSY	469 860	17,8
					478 105	238 / 12					
					478 273	238 / 8					
Kangoo I [FC./KC.]	1,0	43		09.98-12.07	478 124	259 / 20,6	BSY	424 487	17,3	21 980	
1.0i					478 276	238 / 20	BSY	424 487	17,3	21 980	
1.0i16V	1,0	50		02.01-12.07	478 124	259 / 20,6	BSY	424 487	17,3	21 980	
				478 276	238 / 20	BSY	424 487	17,3	21 980		
1.2GPL	1,2	44		10.97-12.07	478 124	259 / 20,6	BSY	424 487	17,3	21 980	
				478 276	238 / 20	BSY	424 487	17,3	21 980		
1.2i	1,2	44		10.97-12.07	478 124	259 / 20,6	BSY	424 487	17,3	21 980	
				478 276	238 / 20	BSY	424 487	17,3	21 980		
1.2i16V	1,2	55		05.00-12.07	478 124	259 / 20,6	BSY	424 487	17,3	21 980	
				478 276	238 / 20	BSY	424 487	17,3	21 980		
1.4i	1,4	55		10.97-12.07	478 124	259 / 20,6	BSY	424 487	17,3	21 980	
				478 276	238 / 20	BSY	424 487	17,3	21 980		
1.5DCI	1,5	48/50/ 60/62		05.00-12.07	478 124	259 / 20,6	BSY	424 487	17,3	21 980	
				478 276	238 / 20	BSY	424 487	17,3	21 980		
1.6i	1,6	66/70		09.99-12.07	478 124	259 / 20,6	BSY	424 487	17,3	21 980	
				478 276	238 / 20	BSY	424 487	17,3	21 980		



				0 986...	0 986...				1 987...	1 987...	
Kangoo I [FC./KC.]	1,6	70	06.00-12.07	▮ 478 590	280 / 24	BSY	424 785	18,1	23 930		
1.6i 4x4											
1.9 D	1,9	40/47/48	10.97-12.07	▮ 478 124	259 / 20,6	BSY	424 487	17,3	21 980		
				▮ 478 276	238 / 20	BSY	424 487	17,3	21 980		
1.9 D DCI	1,9	59	05.00-12.07	▮ 478 124	259 / 20,6	BSY	424 487	17,3	21 980		
				▮ 478 276	238 / 20	BSY	424 487	17,3	21 980		
1.9 D DCI 4x4	1,9	59	05.00-12.07	▮ 478 590	280 / 24	BSY	424 785	18,1	23 930		
1.9 D DTI	1,9	59	09.98-12.07	▮ 478 124	259 / 20,6	BSY	424 487	17,3	21 980		
				▮ 478 276	238 / 20	BSY	424 487	17,3	21 980		
			02.00-12.07	▮ 478 590	280 / 24	BSY	424 785	18,1	23 930		
Mascott 90	2,8	63	01.99-06.04	35T ▮ 479 343	290 / 22						
				56T ▮ 479 342	290 / 26						
110	2,8	78	01.99-06.04	35T ▮ 479 343	290 / 22						
				56T ▮ 479 342	290 / 26						
120	3,0	85	05.04-05.07	35T ▮ 479 343	290 / 22						
				56T ▮ 479 342	290 / 26						
130	2,8	92	01.99-06.04	35T ▮ 479 343	290 / 22						
				56T ▮ 479 342	290 / 26						
140	2,8	103	01.01-06.04	35T ▮ 479 343	290 / 22						
				56T ▮ 479 342	290 / 26						
150	2,8	107	10.01-06.04	35T ▮ 479 343	290 / 22						
				56T ▮ 479 342	290 / 26						
160	3,0	115	05.04-05.07	35T ▮ 479 343	290 / 22						
				56T ▮ 479 342	290 / 26						
Master P28-35	2,0	58/59	10.82-09.97	▮ 479 488	278 / 24	GIR	460 932	15,6	20 380		
-35D	2,4	52	09.80-11.90	▮ 479 488	278 / 24	GIR	460 932	15,6	20 380		
T28-35	2,0	57-59	10.80-09.97	▮ 479 488	278 / 24	GIR	460 932	15,6	20 380		
	2,2	67	09.80-09.97	▮ 479 488	278 / 24	GIR	460 932	15,6	20 380		
	2,4	55	01.94-09.97			GIR	460 932	15,6	20 380		
	2,5	69	01.94-09.97			GIR	460 932	15,6	20 380		
T28-35D	2,1	44	09.80-09.97	▮ 479 488	278 / 24	GIR	460 932	15,6	20 380		
	2,4	52-55	09.80-09.97	▮ 479 488	278 / 24	GIR	460 932	15,6	20 380		
	2,5	69/72	09.80-09.97	▮ 479 488	278 / 24	GIR	460 932	15,6	20 380		
2.5 dCi 100	2,5	74	11.06→	▮ 479 001	305,5 / 28		494 031	17,8	23 613		
2.5 dCi 120	2,5	88	11.06→	▮ 479 001	305,5 / 28		494 031	17,8	23 613		
2.5 dCi 120 FAP	2,5	88	11.06→	▮ 479 001	305,5 / 28		494 031	17,8	23 613		
2.5 dCi 150 FAP	2,5	107	11.06→	▮ 479 001	305,5 / 28		494 031	17,8	23 613		
[X70] 1.9 dCi 80	1,9	60	05.00-07.00	▮ 478 745	280 / 24	BSY	424 480	17,8	23 302		
			05.00-10.06	▮ 479 001	305,5 / 28		494 031	17,8	23 613		
1.9 dTi 80	1,9	58	01.00-07.00	▮ 478 745	280 / 24	BSY	424 480	17,8	23 302		
			01.00-09.03	▮ 479 001	305,5 / 28		494 031	17,8	23 613		
2.2 dCi 90	2,2	66	01.00-07.00			BSY	424 480	17,8	23 302		
			01.00-10.06				494 031	17,8	23 613		
			05.00-07.00	▮ 478 745	280 / 24						
			08.00-10.06	▮ 479 001	305,5 / 28						
2.5 D	2,5	60	10.97-07.00			BSY	424 480	17,8	23 302		
				▮ 478 745	280 / 24						
			10.97-09.03				494 031	17,8	23 613		
				▮ 478 745	280 / 24						
			08.00-09.03	▮ 479 001	305,5 / 28						
2.5 dCi 90	2,5	84	05.00-07.00			BSY	424 480	17,8	23 302		
			05.00-09.03				494 031	17,8	23 613		
			08.00-09.03	▮ 479 001	305,5 / 28						
2.5 dCi 100	2,5	73	10.03-10.06	▮ 479 001	305,5 / 28		494 031	17,8	23 613		
2.5 dCi 110	2,5	73	10.03-10.06	▮ 479 001	305,5 / 28		494 031	17,8	23 613		
2.5 dCi 120	2,5	84	07.02-10.06	▮ 479 001	305,5 / 28		494 031	17,8	23 613		
2.8 D	2,8	86	05.01-10.04	▮ 479 001	305,5 / 28		494 031	17,8	23 613		
2.8 dTi 110	2,8	84	10.97-07.00			BSY	424 480	17,8	23 302		
			10.97-09.03				494 031	17,8	23 613		
			10.97-07.00	▮ 478 745	280 / 24						
			08.00-09.03	▮ 479 001	305,5 / 28						



				0 986...	0 986...			1 987...	1 987...	
RENAULT										
Master [X70]	2,8	84		10.97-07.00	478 745	280 / 24	BSY	424 480	17,8	23 302
2.8 dTi 120				10.97-09.03				494 031	17,8	23 613
				08.00-09.03	479 001	305,5 / 28				
3.0 dCi 140	3,0	100		10.03-10.06	479 001	305,5 / 28		494 031	17,8	23 613
Traffic 1.4	1,4	36		09.80-10.97	478 113	252,5 / 24	BSY	464 881		20 488
				ZWZ	478 113	252,5 / 24	BSY	460 946	18,5	20 926
1.6	1,6	46/48/ 49		09.80-02.89	478 113	252,5 / 24	BSY	464 881		20 488
				ZWZ	478 113	252,5 / 24	BSY	460 946	18,5	20 926
1.7	1,7	50-58		03.89-10.97	478 113	252,5 / 24	BSY	464 881		20 488
				ZWZ	478 113	252,5 / 24	BSY	460 946	18,5	20 926
1.9D	1,9	47-48		11.97-05.01	478 113	252,5 / 24	BSY	460 946	18,5	20 926
2.0	2,0	58-63		09.80-02.89	478 113	252,5 / 24	BSY	464 881		20 488
				ZWZ	478 113	252,5 / 24	BSY	460 946	18,5	20 926
		59		09.80-10.97	478 113	252,5 / 24	BSY	464 881		20 488
				ZWZ	478 113	252,5 / 24	BSY	460 946	18,5	20 926
2.1D	2,1	43/47		09.80-10.97	478 113	252,5 / 24	BSY	464 881		20 488
				ZWZ	478 113	252,5 / 24	BSY	460 946	18,5	20 926
2.2i	2,2	69-71/ 74		03.89-10.97	478 113	252,5 / 24	BSY	464 881		20 488
				ZWZ	478 113	252,5 / 24	BSY	460 946	18,5	20 926
2.5D	2,5	52-55		09.80-10.97	478 113	252,5 / 24	BSY	464 881		20 488
				ZWZ	478 113	252,5 / 24	BSY	460 946	18,5	20 926
		55		11.97-05.01	478 113	252,5 / 24	BSY	460 946	18,5	20 926
2.5 D 4x4	2,5	55		11.97-05.01	478 113	252,5 / 24	BSY	460 946	18,5	20 926
[EL./FL./JL.] 1.9 DCI	1,9	60/74		05.01-12.06	479 078	305,5 / 28	GIR	424 636	18,4	23 099
2.0 DCI	2,0	66/85		01.06→	479 078	305,5 / 28	GIR	424 636	18,4	23 099
16V	2,0	86		06.01→	479 078	305,5 / 28	GIR	424 636	18,4	23 099
2.5 DCI	2,5	98		06.02→	479 078	305,5 / 28	GIR	424 636	18,4	23 099
4 (F4/F6)	1,1	25		10.82-12.93	478 103	227,5 / 10	BSY	461 396	14	20 347
[R2106-R2430] 1.1							GIR	464 801	15,5	20 480

SEAT

Inca 1.6 EFI	1,6	66		11.98→	1LY		GIR	460 943	16	20 168	
				03.99→			GIR	494 010	16,3	21 945	
[6K9] 1.4	1,4	44/55	PR no. 1LL	11.95-06.03		478 329	255,8 / 13	GIR	460 944	19,5	20 168
			PR no. 1LY PR no. 1ZK	11.95-06.03		478 308	256 / 20	GIR	494 010	16,3	21 945
1.6	1,6	55	PR no. 1LL	11.95-09.00		478 329	255,8 / 13	GIR	460 944	19,5	20 168
			PR no. 1LY PR no. 1ZK	11.95-09.00		478 308	256 / 20	GIR	494 010	16,3	21 945
1.7D	1,7	42	PR no. 1LL	09.96-09.00		478 329	255,8 / 13	GIR	460 944	19,5	20 168
			PR no. 1LY PR no. 1ZK	09.96-09.00		478 308	256 / 20	GIR	494 010	16,3	21 945
1.9D	1,9	47	PR no. 1LL	11.95-06.03		478 329	255,8 / 13	GIR	460 944	19,5	20 168
			PR no. 1LY PR no. 1ZK	11.95-06.03		478 308	256 / 20	GIR	494 010	16,3	21 945
1.9 SDI	1,9	47	PR no. 1LL	12.95-06.03		478 329	255,8 / 13	GIR	460 944	19,5	20 168
			PR no. 1LY PR no. 1ZK	12.95-06.03		478 308	256 / 20	GIR	494 010	16,3	21 945
Terra 0.9	0,9	29		01.87-12.94		478 063	227 / 10,8				
			ABF,KW, OVA					BSY	424 098	18	20 775
			ABF,NKW					BSY	460 736	17,3	20 073
1.3D	1,3	33		03.90-12.94		478 063	227 / 10,8				
			ABF,KW					BSY	424 098	18	20 775
			ABF,NKW					BSY	460 736	17,3	20 073
1.4D	1,4	35		10.90-12.94		478 063	227 / 10,8				
			ABF,KW					BSY	424 098	18	20 775
			ABF,NKW					BSY	460 736	17,3	20 073

SKODA

Pick-Up [6U7] 1.6 MPI	1,6	55		10.95-03.01		478 859	236 / 13	GIR	424 373	17,5	21 662
1.9D	1,9	47		01.96-03.01		478 859	236 / 13	GIR	424 373	17,5	21 662

				0986..		0986..		1987..		1987..	
Pick-Up [6U7] 135	1,3	40		09.91-12.92		FDO, GIR	468 613	17,5	20 861		
				09.91-12.97	‡ 478 776	236 / 12,6	GIR,	424 373	17,5	21 662	
				01.93-03.94	‡ 479 491	236 / 12,7					
				04.94-12.97	‡ 478 859	236 / 13					
		42/43		09.91-12.92	‡ 478 776	236 / 12,6	FDO, GIR	468 613	17,5	20 861	
				09.91-12.97	‡ 478 859	236 / 13	GIR,	424 373	17,5	21 662	
				01.93-03.94	‡ 479 491	236 / 12,7					
135 i.e.	1,3	40		07.93-12.97	‡ 479 491	236 / 12,7	GIR	424 373	17,5	21 662	
				04.94-12.97	‡ 478 859	236 / 13	GIR	424 373	17,5	21 662	
135 MPI	1,3	40		08.96-03.01	‡ 478 859	236 / 13	GIR	424 373	17,5	21 662	
136 i.e.	1,3	50		07.93-12.97	‡ 479 491	236 / 12,7	GIR	424 373	17,5	21 662	
				04.94-12.97	‡ 478 859	236 / 13	GIR	424 373	17,5	21 662	
136 MPI	1,3	50		08.96-03.01	‡ 478 859	236 / 13	GIR	424 373	17,5	21 662	
SUBARU											
Libero [KJ] 1.0	1,0	37		10.83-04.93	‡ 478 392	212 / 18	SUM	469 580	16	20 958	
1.2 4WD	1,2	38		10.86-04.93	‡ 478 392	212 / 18	SUM	469 580	16	20 958	
SUZUKI											
Alto Van 0.6	0,5	25		09.88-01.89	‡ 478 376	215 / 10					
0.7	0,7	26-29		03.90-11.94	‡ 478 376	215 / 10					
Carry 0.6	0,6	25		05.89-03.90	‡ 478 376	215 / 10					
0.7	0,7	28-31		10.90-05.95	‡ 478 376	215 / 10					
1.0	1,0	31		07.90-09.94				487 324			
								487 427			
				12.93-09.94			SUM	467 311	20 731		
[ED] 1.0	1,0	33		10.85-10.93			SUM	467 311	20 731		
				10.85-03.99	‡ 478 376	215 / 10					
[FD] 1.3 16V	1,3	58		03.99-03.09			SUM	424 695	15	23 507	
[ST] 800	0,8	27		11.80-10.85				487 324			475 128
				WW				487 427			
Carry Van [ED] 1.0	1,0	33		10.85-10.93			SUM	467 311	20 731		
				10.85-03.99	‡ 478 376	215 / 10					
SJ 410 1.0	1,0	33		10.86-12.88	‡ 478 377	290 / 10	SUM	460 935	15	21 142	
SJ 410 Pickup 1.0	1,0	33		09.81-12.88	‡ 478 377	290 / 10	SUM	460 935	15	21 142	
TALBOT											
Express [J 5] 1.8	1,8	50	Fg.no. →0154461	09.81-07.84	‡ 478 067	257 / 12	GIR	467 411	19	20 741	
			Fg.no. 0154462→	07.84-12.93	‡ 478 200	255 / 16	GIR	467 411	19	20 741	
1.9 D	1,9	51	Fg.no. 0154462→	11.87-12.93	‡ 478 200	255 / 16	GIR	467 411	19	20 741	
2.0	2,0	57	Fg.no. →0154461	09.81-07.84	‡ 478 067	257 / 12	GIR	467 411	19	20 741	
			Fg.no. 0154462→	07.84-12.93	‡ 478 200	255 / 16	GIR	467 411	19	20 741	
		72	Fg.no. 0154462→	07.87-12.93	‡ 478 200	255 / 16	GIR	467 411	19	20 741	
2.5 D	2,5	55	Fg.no. →0154461	09.81-07.84	‡ 478 067	257 / 12	GIR	467 411	19	20 741	
			Fg.no. 0154462→	07.84-12.93	‡ 478 200	255 / 16	GIR	467 411	19	20 741	
2.5 D Turbo	2,5	70	Fg.no. 0154462→	07.87-12.93	‡ 478 234	290 / 16	GIR	460 998	19,5	21 205	
1100 1.1 City Laster	1,1	37-43		07.83-06.85	‡ 478 121	238 / 11	BSY	465 733		20 573	
TOYOTA											
Corolla Van 1.3	1,3	54		08.87-09.91	‡ 478 506	238 / 12					
				09.91-01.94	‡ 478 385	238 / 18					

				0 986...	0 986...	1 987...	1 987...
◀ TOYOTA							
Corolla Van 1.3 i	1,3	59-69	01.94-06.02	🔧 478 385	238 / 18		
1.5	1,5	58	08.87-09.91	🔧 478 506	238 / 12		
i	1,5	65-71	01.94-06.02	🔧 478 385	238 / 18		
1.8D	1,8	47	08.87-09.91	🔧 478 506	238 / 12		
2.0D	2,0	54	09.91-04.98	🔧 478 385	238 / 18		
2.2D	2,2	58	04.98-06.02	🔧 478 385	238 / 18		
Dyna 100 1.8	1,8	57	08.85-03.88	🔧 478 397	257 / 25		
			08.85-05.95			AKE 424 382	16 21 158
2.5D	2,5	53-55	08.85-03.88	🔧 478 397	257 / 25		
			08.85-05.95			AKE 424 382	16 21 158
Hiace 1.8	1,8	58	10.83-05.85			AKE 424 382	16 21 158
(LWB)	1,8	58	11.86-10.88			AKE 424 382	16 21 158
2.0	2,0	65	07.83-11.85			AKE 424 382	16 21 158
2.2	2,2	70	11.86-10.88			AKE 424 382	16 21 158
[KLH] 2.5 D Turbo	2,5	65/75	08.01→ ABO	🔧 478 693	285 / 28	SUM 424 319	15,5 21 468
1.3 D Turbo 4WD	2,5	75	08.01→			SUM 424 319	15,5 21 468
[LH] 2.2 D	2,2	49	12.82-01.84	🔧 478 397	257 / 25	AKE 424 382	16 21 158
2.4 D	2,4	62	08.82-08.89	🔧 478 397	257 / 25	AKE 424 382	16 21 158
2.4 D 4WD	2,4	62	08.86-08.89			SUM 424 319	15,5 21 468
[LXH] 2.4 D	2,4	62	08.95-08.01 ABO	🔧 478 693	285 / 28	SUM 424 319	15,5 21 468
2.4 D Turbo	2,4	66	08.95-08.01 ABO	🔧 478 693	285 / 28	SUM 424 319	15,5 21 468
2.4 D Turbo 4WD	2,4	66	08.96-08.01			SUM 424 319	15,5 21 468
[RCH] 2.4	2,4	85	03.97→ ABO	🔧 478 693	285 / 28	SUM 424 319	15,5 21 468
2.4 i	2,4	85	08.95→ ABO	🔧 478 693	285 / 28	SUM 424 319	15,5 21 468
2.4 i 4WD	2,4	85	08.96-04.98			SUM 424 319	15,5 21 468
2.7	2,7	105	04.98→ ABO	🔧 478 693	285 / 28	SUM 424 319	15,5 21 468
2.7 4x4	2,7	105	04.98→			SUM 424 319	15,5 21 468
[YH] 1.8	1,8	57	12.82-08.86	🔧 478 397	257 / 25	AKE 424 382	16 21 158
2.0	2,0	65	08.86-08.89	🔧 478 397	257 / 25	AKE 424 382	16 21 158
2.2	2,2	69	08.86-08.87	🔧 478 397	257 / 25	AKE 424 382	16 21 158
Hiace Commuter 2.4 i	2,4	88	08.98-07.03	🔧 478 693	285 / 28		
3.0D	3,0	67	Org.no. KG-LH184B 08.98-10.04	🔧 478 693	285 / 28		
Hiace Truck 1.8	1,8	58	10.89-05.95	🔧 478 397	257 / 25		
2.0	2,0	65	05.95-10.96	🔧 478 397	257 / 25		
2.4 D	2,4	63	08.88-05.95	🔧 478 397	257 / 25		
2.4 D 4WD	2,4	63	10.89-05.95			SUM 424 319	15,5 21 468
Hiace Van 2.0	2,0	74	08.89-08.93	🔧 478 452	255 / 25		
2.4 D	2,4	56	09.87-08.89			AKE 424 382	16 21 158
		63	08.89-08.93	🔧 478 452	255 / 25		
2.8D	2,8	67	08.89-08.96	🔧 478 452	255 / 25	SUM 424 225	15,5 21 689
			09.96-08.98	🔧 478 693	285 / 28	SUM 424 225	15,5 21 689
3.0D	3,0	67	08.98-10.04	🔧 478 693	285 / 28		
[LH] 2.4 D	2,4	62	08.89-01.05 TW	🔧 478 452	255 / 25		
			05.94-01.05 TW	🔧 479 427	285 / 28		
2.4 D 4WD	2,4	62	08.89-08.95	🔧 479 427	285 / 28		
2.8D	2,8	58	08.89-08.00	🔧 479 427	285 / 28		
[LXH] 2.4 D Turbo	2,4	66	08.96-08.01			SUM 424 319	15,5 21 468
[ZH] 2.0	2,0	74	08.89-09.02	🔧 478 452	255 / 25		
2.4	2,4	84	08.89-02.06	🔧 479 427	285 / 28	SUM 424 319	15,5 21 468
2.4 i	2,4	88	08.89-08.93	🔧 478 452	255 / 25		
			08.89-02.05	🔧 479 427	285 / 28	SUM 424 319	15,5 21 468
2.4 i 4WD	2,4	88	08.89-07.95			SUM 424 319	15,5 21 468
Hiace Wagon [LH]	2,4	62	08.89-02.06 TW	🔧 478 452	255 / 25		
2.4 D			05.94-02.06 TW	🔧 479 427	285 / 28		
			08.90-10.91 TW			SUM 424 225	15,5 21 689
			09.95-08.04 TW			SUM 424 319	15,5 21 468
2.8D	2,8	58	08.89-08.00	🔧 479 427	285 / 28		
3.0D	3,0	65	08.98-02.06 TW	🔧 478 452	255 / 25		
			TW	🔧 479 427	285 / 28	SUM 424 225	15,5 21 689
						424 319	15,5 21 468
	75		08.01-02.06 TW	🔧 478 452	255 / 25	SUM 424 225	15,5 21 689
			TW	🔧 479 427	285 / 28	SUM 424 225	15,5 21 689

				0 986...	0 986...				1 987...	1 987...	
Hiace Wagon [ZH]	2,4	88		08.89-08.93	▮ 478 452	255 / 25					
2.4 i				08.89-09.02	▮ 479 427	285 / 28	SUM	424 319	15,5	21 468	
Hilux 1.6	1,6	50		06.84-11.85			AKE	424 382	16	21 158	
2.2 4x4	2,2	70		02.86-06.94			AKE	424 382	16	21 158	
				02.86-08.98	▮ 478 304	302 / 12,5					
2.4 D Turbo	2,4	64		05.95-12.00	▮ 478 397	257 / 25	AKE	424 382	16	21 158	
2.4 D 4x4	2,4	55		01.89-04.92			SUM	468 520	15,5	20 852	
				01.89-09.95	▮ 478 304	302 / 12,5					
2.4 4x4	2,4	80		02.94-08.98			AKE	424 382	16	21 158	
2.8 D	2,8	65		01.95-08.98			AKE	424 382	16	21 158	
[Africa] 3.0 D 4x4	3,0	67		01.98→	▮ 478 453	289 / 20	SUM	424 268	15	21 680	
[N3/N4] 2.0 4x4	2,0	62		08.80-07.83	▮ 478 304	302 / 12,5					
2.2 D	2,2	49		08.80-07.83				487 292		475 143	
2.2 D 4WD	2,2	49		08.81-07.83	▮ 478 304	302 / 12,5	SUM	468 520	15,5	20 852	
[N5/N6] 1.6	1,6	50		08.86-07.98	▮ 478 397	257 / 25					
1.8	1,8	65		08.87-08.88	▮ 478 397	257 / 25	AKE	424 382	16	21 158	
2.0	2,0	65		09.83-08.88	▮ 478 397	257 / 25					
2.2	2,2	75		08.86-07.98	▮ 478 397	257 / 25					
2.2 D	2,2	49		08.83-08.84	▮ 478 397	257 / 25					
2.4	2,4	80		01.86-07.98	▮ 478 397	257 / 25					
				08.87-07.98			AKE	424 382	16	21 158	
2.4 D	2,4	62		08.84-07.98	▮ 478 453	289 / 20					
2.8 D	2,8	58		08.95-07.98	▮ 478 397	257 / 25					
[N8] 1.8	1,8	58		09.88-08.94	▮ 478 397	257 / 25					
[N10] 2.0 i 4x4	2,0	71		08.94-08.97	▮ 478 453	289 / 20	SUM	424 268	15	21 680	
2.0 4WD	2,0	65		09.88-08.94			SUM	424 268	15	21 680	
2.8 D 4WD	2,8	67		09.88-08.97			SUM	424 268	15	21 680	
[N14] 3.0 D	3,0	67		08.97-06.04	▮ 478 397	257 / 25	SUM	424 225	15,5	21 689	
[N14/N15] 2.0 i	2,0	81		08.97-07.04			SUM	424 225	15,5	21 689	
[N16/N17] 2.0 i 4x4	2,0	81		08.97-08.99	▮ 478 453	289 / 20	SUM	424 268	15	21 680	
2.7 i 4WD	2,7	107		08.99-07.04	▮ 478 453	289 / 20	SUM	424 268	15	21 680	
3.0 D 4x4	3,0	67		08.97-06.04			SUM	424 268	15	21 680	
[Raider] 3.0 D 4x4	3,0	85		01.98-12.02	▮ 478 453	289 / 20	SUM	424 268	15	21 680	
3.0 TD	3,0	85		07.00-02.02	▮ 478 453	289 / 20	SUM	424 268	15	21 680	
Hilux Pickup [N8] 1.8	1,8	57		01.89-10.94	▮ 478 397	257 / 25					
[N8/N9/N10/ N11/N13] 1.8	1,8	57		08.88-08.94	▮ 478 397	257 / 25					
2.2 4WD	2,2	69		08.88-08.94	▮ 478 397	257 / 25	SUM	424 268	15	21 680	
					▮ 478 453	289 / 20	SUM	424 268	15	21 680	
2.4 D	2,4	62		08.88-07.97	▮ 478 453	289 / 20	SUM	424 268	15	21 680	
				08.88-08.97	▮ 478 397	257 / 25	SUM	424 268	15	21 680	
2.4 D 4x4	2,4	62		09.88-08.97	▮ 478 397	257 / 25	SUM	424 268	15	21 680	
				08.91-08.97	▮ 478 453	289 / 20	SUM	424 268	15	21 680	
2.4 i 4WD	2,4	84		08.89-08.97	▮ 478 453	289 / 20	SUM	424 268	15	21 680	
2.4 i 4x4	2,4	84		08.88-08.97	▮ 478 453	289 / 20	SUM	424 268	15	21 680	
[N14/N15/N16/ N17/N19] 2.4 D	2,4	62		08.97-08.01	▮ 478 453	289 / 20	SUM	424 225	15,5	21 689	
2.4 D Turbo	2,4	66		08.97-08.01	▮ 478 453	289 / 20	SUM	424 268	15	21 680	
2.4 i	2,4	104		08.97-08.99	▮ 478 453	289 / 20	SUM	424 268	15	21 680	
2.4 i 4WD	2,4			11.97-08.01	▮ 478 453	289 / 20	SUM	424 268	15	21 680	
2.5 D Turbo	2,5	65/75	Fg.no. *KDN145*	08.01-08.05	▮ 478 453	289 / 20	SUM	424 225	15,5	21 689	
			Fg.no. *KDN150*								
			Fg.no. *KDN165*	08.01-08.05	▮ 478 453	289 / 20	SUM	424 268	15	21 680	
			Fg.no. *KDN170*								
			Fg.no. *KDN190*								
Hilux Tiger D4D	2,5	76		11.01-09.04			AKE	424 382	16	21 158	
2.5 D Turbo 4x4											
3.0 D 4x4	3,0	72		11.98-11.00	ML3,ML5	▮ 478 453	289 / 20	AKE	424 382	16	21 158
					ML6,ML7	▮ 478 453	289 / 20	SUM	424 268	15	21 680
Hilux Wagon [N8/N9/ N10/N11/N13]	2,4	69		01.90-11.95	▮ 478 453	289 / 20	SUM	424 268	15	21 680	
2.4 D Turbo				08.91-11.95	▮ 478 629	291 / 25					
3.0 D	3,0	92		08.93-11.95	▮ 478 629	291 / 25	SUM	424 268	15	21 680	



				0 986...	0 986...		1 987...	1 987...
◀ TOYOTA								
Hilux Wagon [N8/N9/N10/N11/N13] i	3,0	105	08.91-11.95	478 629	291 / 25	SUM	424 268	15 21 680
Land Cruiser [70] 4.2 D 4x4	4,2	96	05.00→			SUM	424 640	17,6 23 524
Liteace [M2] 1.3	1,3	43	10.82-08.85	478 398	230,5 / 20	AKE	424 133	20 182
1.6	1,6		02.84-08.85	478 398	230,5 / 20	AKE	424 133	20 182
1.8	1,8	57	11.83-08.85	478 398	230,5 / 20	AKE	424 133	20 182
1.8D	1,8	48	10.82-08.85	478 398	230,5 / 20	AKE	424 133	20 182
[M3] 1.5	1,5	48	10.85-08.88	478 106	255 / 20	AKE	424 183	15,5 21 837
		51	10.85-08.88	478 106	255 / 20	AKE	424 183	15,5 21 837
1.8D	1,8	47	10.85-08.88	478 106	255 / 20	AKE	424 133	20 182
			ZWZ	478 106	255 / 20	AKE	424 183	15,5 21 837
2.0D	2,0	53	08.88-01.92	478 106	255 / 20	AKE	424 133	20 182
			ZWZ	478 106	255 / 20	AKE	424 183	15,5 21 837
Liteace Truck 1.3	1,3	43	10.86-08.90			AKE	424 133	20 182
1.5	1,5	51	10.86-06.99			AKE	424 133	20 182
1.8	1,8	58	10.86-06.99			AKE	424 133	20 182
2.0D	2,0	54	08.87-06.99			AKE	424 133	20 182
Liteace Van 1.8	1,8	58	08.90-01.92			AKE	424 133	20 182
2.0D 4WD	2,0	54	08.87-08.88			AKE	424 137	21 015
Sequoia 4.7	4,7	179-204	09.00-08.07			SUM	494 153	24024
Sprinter Van 1.3i	1,3	59-69	01.94-06.02	478 385	238 / 18			
Townace Truck 1.5	1,5	51	10.86-06.99			AKE	424 133	20 182
1.8	1,8	58	10.86-06.99			AKE	424 133	20 182
2.0D	2,0	54	08.87-06.99			AKE	424 133	20 182
			Org.no. CM52					

VAUXHALL

Arena 1.9D	1,9	44	03.98-08.01	478 113	252,5 / 24	BSY	460 946	18,5 20 926
2.5	2,5	55	03.98-08.01	478 113	252,5 / 24	BSY	460 946	18,5 20 926
2.5D	2,5	55	03.98-08.01	478 113	252,5 / 24	BSY	460 946	18,5 20 926
Brava Pick-Up [TF0]	2,2	39	06.89-09.96	478 596	257,5 / 22,1	AKE	460 960	21 544 474 257
2.2D								
2.3	2,3	69	09.91-09.96	478 596	257,5 / 22,1	AKE	460 960	21 544 474 257
2.3i	2,3	72	09.91-09.96	478 596	257,5 / 22,1	AKE	460 960	21 544 474 257
2.5D	2,5	56-74	02.89-09.96	478 596	257,5 / 22,1	AKE	460 960	21 544 474 257
2.5TD	2,5	56	10.89-12.96	478 596	257,5 / 22,1	AKE	460 960	21 544 474 257
3.1TD	3,1	80	03.95-12.96	478 596	257,5 / 22,1	AKE	460 960	21 544 474 257
[TF1] 2.5TD	2,5	56	03.97-08.02	478 596	257,5 / 22,1	AKE	460 960	21 544 474 257
3.1TD	3,1	80	03.97-08.02	478 596	257,5 / 22,1	AKE	460 960	21 544 474 257
Combo 1.2i	1,2	33	09.94-10.01	478 192	236 / 20	ATE	460 938	21 353 474 179
1.4i	1,4	44	09.94-10.01	478 192	236 / 20	ATE	460 938	21 353 474 179
		60	09.94-10.01	478 192	236 / 20	ATE	460 938	21 353 474 179
		66	08.99-10.01	478 192	236 / 20	ATE	460 938	21 353 474 179
1.7D	1,7	44	09.94-10.01	478 192	236 / 20	ATE	460 938	21 353 474 179
[Tour] 1.3 CDTi	1,3	51	Fg.no. →4303389 09.04→	478 730	260,5 / 24	GIR	424 527	17 23 225
			Fg.no. 53000001→ 09.04→	478 730	260,5 / 24	ATE	424 707	23 832
		55	Fg.no. →4303389 03.06→	478 730	260,5 / 24	GIR	424 527	17 23 225
			Fg.no. 53000001→ 03.06→	478 730	260,5 / 24	ATE	424 707	23 832
1.4i Twinport	1,4	66	Fg.no. →4303389 01.04→	478 730	260,5 / 24	GIR	424 527	17 23 225
			Fg.no. 53000001→ 01.04→	478 730	260,5 / 24	ATE	424 707	23 832
1.4i Twinport Dualfuel	1,4	65	Fg.no. →4303389 09.04→	478 730	260,5 / 24	GIR	424 527	17 23 225
			Fg.no. 53000001→ 09.04→	478 730	260,5 / 24	ATE	424 707	23 832



				0 986...	0 986...			1 987...	1 987...
Combo [Tour]	1,6	69-71	04.05→		ATE	424 707	23 832		
1.6 CNG					GIR	424 527	17 23 225		
			TW	478 730	260,5 / 24				
				479 077	280 / 25				
1.6 i	1,6	64	10.01-08.04	478 730	260,5 / 24	GIR	424 527	17 23 225	
1.7 CDTi	1,7	74	09.04→	478 730	260,5 / 24	ATE	424 707	23 832	
1.7 DI	1,7	48	09.01-08.04	478 730	260,5 / 24	GIR	424 527	17 23 225	
1.7 DTI	1,7	55	10.01-08.04	478 730	260,5 / 24	GIR	424 527	17 23 225	
Euromidi 2.0	2,0	74	09.88-08.96	AA,MC1	478 658	SUM	424 157	21 115	
2.0 DT	2,0	51	09.88-08.96	AA,MC1	478 658	SUM	424 157	21 115	
			Fg.no. →KV637435	09.88-08.96	MC1	SUM	424 157	21 115	
			Fg.no. KV637436→	09.88-08.96		SUM	424 157	21 115	
2.2 D	2,2	45	09.88-08.96	MC2,MC3	478 658	SUM	424 157	21 115	
			Fg.no. →KV637435	09.88-08.96	MC1	SUM	424 157	21 115	
			Fg.no. KV637436→	09.88-08.96		SUM	424 157	21 115	
2.4 DT	2,4	56	09.88-08.96	MC2,MC3	478 658	SUM	424 157	21 115	
			Fg.no. →KV637435	09.88-08.96	MC1	SUM	424 157	21 115	
			Fg.no. KV637436→	09.88-08.96		SUM	424 157	21 115	
Movano 1.9 D	1,9	59	01.99-10.01	15Z	478 745	BSY	424 480	17,8 23 302	
				16Z	479 001		494 031	17,8 23 613	
1.9 DTI	1,9	60	10.01-10.05	15Z	478 745	BSY	424 480	17,8 23 302	
				15Z	479 001		494 031	17,8 23 613	
2.2 DTI	2,2	66	01.01-10.05	15Z		BSY	424 480	17,8 23 302	
				16Z	479 001		494 031	17,8 23 613	
2.5 D	2,5	59	10.98-10.05	15Z	478 745	BSY	424 480	17,8 23 302	
				16Z	479 001		494 031	17,8 23 613	
2.5 DTI	2,5	74-107	10.01→	15Z	478 745	BSY	424 480	17,8 23 302	
				16Z	479 001		494 031	17,8 23 613	
2.8 DTI	2,8	84	06.98-10.05	15Z	478 745	BSY	424 480	17,8 23 302	
				16Z	479 001		494 031	17,8 23 613	
3.0 DTI	3,0	100	10.03-10.05	15Z	478 745	BSY	424 480	17,8 23 302	
				16Z	479 001		494 031	17,8 23 613	
Vivaro 1.9 DI	1,9	59-60	03.01-08.06		479 078				
			Fg.no. →6V699999	03.01-08.06		GIR	424 636	18,4 23 099	
			→6Y999999						
1.9 DTI	1,9	74	03.01-08.06		479 078				
			Fg.no. →6V699999	03.01-08.06		GIR	424 636	18,4 23 099	
			→6Y999999						
2.0 CDTI	2,0	66	08.06→		479 078				
			Fg.no. →6V699999	08.06→		GIR	424 636	18,4 23 099	
			→6Y999999						
		84	08.06→		479 078				
			Fg.no. →6V699999	08.06→		GIR	424 636	18,4 23 099	
			→6Y999999						
2.0 16V	2,0	86-88	03.01→		479 078				
			Fg.no. →6V699999	03.01→		GIR	424 636	18,4 23 099	
			→6Y999999						
2.5 CDTI	2,5	84	09.06-06.08		479 078				
			Fg.no. →6V699999	09.06-06.08		GIR	424 636	18,4 23 099	
			→6Y999999						
		107	08.06→		479 078				
			Fg.no. →6V699999	08.06→		GIR	424 636	18,4 23 099	
			→6Y999999						
2.5 DTI	2,5	99	04.04-08.06		479 078				
			Fg.no. →6V699999	04.04-08.06		GIR	424 636	18,4 23 099	
			→6Y999999						

VW (VOLKSWAGEN)

Caddy [2K] 1.4	1,4	55	PR no. 1ZE	02.04-05.06	479 088	288 / 25	ATE	424 797	20,3 23 587
			PR no. 1ZF; 1ZM	02.04-05.06	479 098	280 / 22	ATE	494 019	19,5 23 187
		59	PR no. 1ZE	05.06-05.08	479 088	288 / 25	ATE	424 797	20,3 23 587



				0 986...	0 986...	1 987...	1 987...				
◀VW											
Caddy [2K]	1.4	59	PR no. 1ZF; 1ZM	05.06-05.08	479 098	280 / 22	ATE	494 019	19,5	23 187	
	1.6	75	PR no. 1ZE	04.04-05.08	479 088	288 / 25	ATE	424 797	20,3	23 587	
			PR no. 1ZF; 1ZM	04.04-05.08	479 098	280 / 22	ATE	494 019	19,5	23 187	
	1.9 TDI	55	PR no. 1ZE	09.05-05.08	479 088	288 / 25	ATE	424 797	20,3	23 587	
		77	PR no. 1ZF; 1ZM	09.05-05.08	479 098	280 / 22	ATE	494 019	19,5	23 187	
			PR no. 1ZE	02.04-05.08	479 088	288 / 25	ATE	424 797	20,3	23 587	
			PR no. 1ZF; 1ZM	02.04-05.08	479 098	280 / 22	ATE	494 019	19,5	23 187	
	2.0 Eco Fuel	2,0	PR no. 1LJ	04.06-05.08	479 058	312 / 25	ATE	424 797	20,3	23 587	
			PR no. 1ZE	04.06-05.08	479 088	288 / 25	ATE	424 797	20,3	23 587	
	2.0 SDI	51	PR no. 1ZE	02.04-05.08	479 088	288 / 25	ATE	424 797	20,3	23 587	
			PR no. 1ZF; 1ZM	02.04-05.08	479 098	280 / 22	ATE	494 019	19,5	23 187	
	2.0 TDI	103	PR no. 1LJ	09.07-05.08	479 058	312 / 25	ATE	424 797	20,3	23 587	
			PR no. 1ZE	09.07-05.08	479 088	288 / 25	ATE	424 797	20,3	23 587	
[9K9]	1.4	44/55		11.95-06.03	478 308	256 / 20	GIR	424 468	16,1	21 945	
	1.6	55		11.95-09.00	478 329	255,8 / 13	GIR	460 944	19,5	20 168	474 253
					478 308	256 / 20	GIR	424 468	16,1	21 945	
					478 329	255,8 / 13	GIR	460 944	19,5	20 168	474 253
	1.7 SDI	42		07.96-09.00	478 308	256 / 20	GIR	424 468	16,1	21 945	
					478 329	255,8 / 13	GIR	460 944	19,5	20 168	474 253
	1.9 D/SDI	47		11.95-06.03	478 308	256 / 20	GIR	424 468	16,1	21 945	
					478 329	255,8 / 13	GIR	460 944	19,5	20 168	474 253
	1.9 TDI	66		10.96-06.03	478 308	256 / 20	GIR	424 468	16,1	21 945	
					478 329	255,8 / 13	GIR	460 944	19,5	20 168	474 253
Caddy Pickup [9U7]	1.6	55		06.96-12.00	478 859	236 / 13	GIR	424 373	17,5	21 662	
	1.9 D	47		06.96-12.00	478 859	236 / 13	GIR	424 373	17,5	21 662	
[14, 1A]	1.5	51		08.82-07.83	478 011	239 / 11,9	KEL	468 870	19,6	20 887	474 137
	1.6	55		08.82-07.92	478 011	239 / 11,9	KEL	468 870	19,6	20 887	474 137
	1.6 D	40		08.82-07.92	478 011	239 / 11,9	KEL	468 870	19,6	20 887	474 137
	1.8	70		08.85-07.92	478 011	239 / 11,9	KEL	468 870	19,6	20 887	474 137
Crafter 30 [2E]	2.5 TDI	65/80/100/120		04.06→	479 294	300 / 28	BRB	494 121		29192	473 037
Crafter 35 [2E]	2.5 TDI	65/80/100/120		04.06→	479 294	300 / 28	BRB	494 121		29192	473 037
Crafter 50 [2E]	2.5 TDI	80/100/120		04.06→	479 294	300 / 28					473 037
Eurovan [70]	2.5	81		09.91-12.93			GIR	460 954	18,1	20 652	
	2.8	103		05.96-05.00			GIR	461 753	19	21 479	
							GIR	460 954	18,1	20 652	
			Fg.no. 70-T-200 001→	05.96-05.00				494 008	19,6	21 883	
LT [2D, 2H]	28/35 2.3	105		05.96-11.01			ATE	424 218	20,6	21 576	
	28/35 2.5 SDI	55		05.96-04.01	478 849	276 / 22	ATE	424 218	20,6	21 576	
	28/35 2.5 TDI	61/66/70/75/80		05.96-04.06	478 849	276 / 22	ATE	424 218	20,6	21 576	
	28/35 2.8 D Turbo	92		07.97-12.98	478 849	276 / 22	ATE	424 218	20,6	21 576	
		96		01.99-01.02	478 849	276 / 22	ATE	424 218	20,6	21 576	
	28/35 2.8 TDI	116		02.02-04.06	478 849	276 / 22	ATE	424 218	20,6	21 576	
	46 2.3	105		05.96-11.01			ATE	424 832	20	29 153	473 007
	46 2.5 SDI	55		05.96-04.01	478 849	276 / 22	ATE	424 832	20	29 153	473 007
	46 2.5 TDI	61/66/70/75/80		05.96-04.06	478 849	276 / 22	ATE	424 832	20	29 153	473 007
	46 2.8 D Turbo	92		07.97-12.98	478 849	276 / 22	ATE	424 832	20	29 153	473 007
		96		01.99-01.02	478 849	276 / 22	ATE	424 832	20	29 153	473 007
	46 2.8 TDI	116		02.02-04.06	478 849	276 / 22	ATE	424 832	20	29 153	473 007
[28, 29, 21]	2,0	51/55	Fg.no. 28-B-018 541→	03.81-11.82	478 138	281 / 20					
	28/31/35 2.0										
	28/31/35 2.4	62	Fg.no. 28-B-018 541→	04.83-07.86	478 138	281 / 20	ATE	462 803	17,5	20 280	474 002
		66		12.82-07.92	478 138	281 / 20	ATE	462 803	17,5	20 280	474 002
		70		10.88-04.96	478 138	281 / 20	ATE	462 803	17,5	20 280	474 002
	28/31/35 2.4 D	51		08.89-04.96	478 138	281 / 20	ATE	462 803	17,5	20 280	474 002
		55		12.82-07.92	478 138	281 / 20	ATE	462 803	17,5	20 280	474 002
			Fg.no. 28-B-018 541→	03.81-11.82	478 138	281 / 20					
	28/31/35 2.4 D Turbo	68		08.88-08.92	478 138	281 / 20	ATE	462 803	17,5	20 280	474 002

				0 986...	0 986...				1 987...	1 987...
LT [28, 29, 21]	2,4	70	09.92-04.96	▮ 478 138	281 / 20	ATE	462 803	17,5	20 280	474 002
28/31/35 2.4 D Turbo		75	12.82-08.92	▮ 478 138	281 / 20	ATE	462 803	17,5	20 280	474 002
40/45/50/55 2.4	2,4	62	04.83-07.86			ATE	462 803	17,5	20 280	474 002
			Fg.no. 28-B-018 541→	▮ 478 138	281 / 20					
		66	12.82-07.92	▮ 478 138	281 / 20	ATE	462 803	17,5	20 280	474 002
		70	10.88-04.96	▮ 478 138	281 / 20	ATE	462 803	17,5	20 280	474 002
40/45/50/55 2.4 4x4	2,4	66	09.85-07.92	▮ 478 138	281 / 20	PEO	467 841	18	29 784	474 002
40/45/50/55 2.4 D	2,4	51	08.89-04.96	▮ 478 138	281 / 20	ATE	462 803	17,5	20 280	474 002
		55	12.82-07.92	▮ 478 138	281 / 20	ATE	462 803	17,5	20 280	474 002
			Fg.no. 28-B-018 541→	▮ 478 138	281 / 20					
40/45/50/55 2.4 D 4x4	2,4	55	09.85-07.92	▮ 478 138	281 / 20	PEO	467 841	18	29 784	474 002
40/45/50/55 2.4 D Turbo	2,4	68	08.88-08.92	▮ 478 138	281 / 20	ATE	462 803	17,5	20 280	474 002
		70	09.92-04.96	▮ 478 138	281 / 20	ATE	462 803	17,5	20 280	474 002
		75	12.82-08.92	▮ 478 138	281 / 20	ATE	462 803	17,5	20 280	474 002
40/45/50/55 2.4 D Turbo 4x4	2,4	75	09.85-08.92	▮ 478 138	281 / 20	PEO	467 841	18	29 784	474 002
Microbus	1,9	57	05.82-12.88	GFO	▮ 478 224	258 / 16	ATE	460 111	18,6	20 011
1.9 Watercooled			05.82-12.89	FES	▮ 478 136	278 / 13	ATE	460 111	18,6	20 011
			01.89-12.89		▮ 478 544	257,5 / 16	ATE	460 111	18,6	20 011
2.1 i	2,1	82	11.85-12.88	GFO	▮ 478 224	258 / 16				
			11.85-12.89	FES	▮ 478 136	278 / 13	ATE	460 111	18,6	20 011
			01.89-12.91		▮ 478 544	257,5 / 16				
Taro [7A] 1.8	1,8	61	04.89-09.94		▮ 478 397	257 / 25				474 161
							AKE	424 382	16	21 158
2.2	2,2	69	06.89-07.94		▮ 478 397	257 / 25				474 161
							AKE	424 382	16	21 158
2.4	2,4	84,4	06.89-03.97		▮ 478 397	257 / 25				474 161
							AKE	424 382	16	21 158
2.4 D	2,4	58-61	04.89-03.97		▮ 478 397	257 / 25				474 161
							AKE	424 382	16	21 158
2.4 D 4x4	2,4	58-61	04.89-03.97	OTF	▮ 478 453	289 / 20	SUM	424 268	15	21 680
T3 - Bus;Transporter [24, 25] 1.6 D	1,6	37	01.81-07.87	FES	▮ 478 136	278 / 13	ATE	460 111	18,6	20 011
				FSB	▮ 478 224	258 / 16	GIR	469 790	19,6	20 979
1.6 D Turbo	1,6	51	08.84-07.92	FES	▮ 478 136	278 / 13	ATE	460 111	18,6	20 011
				FSB	▮ 478 224	258 / 16	GIR	469 790	19,6	20 979
1.6 D Turbo Syncro	1,6	51	03.86-07.92	14Z	▮ 478 544	257,5 / 16	GIR	469 790	19,6	20 979
				16Z	▮ 478 065	277 / 16	GIR	469 790	19,6	20 979
1.7 D	1,7	42	10.86-07.92	FES	▮ 478 136	278 / 13	ATE	460 111	18,6	20 011
				FSB	▮ 478 224	258 / 16	GIR	469 790	19,6	20 979
1.9	1,9	40/44/ 54/57/ 60/66	08.82-07.92	FES	▮ 478 136	278 / 13	ATE	460 111	18,6	20 011
				FSB	▮ 478 224	258 / 16	GIR	469 790	19,6	20 979
1.9 Syncro	1,9	54/57	02.85-07.92	14Z	▮ 478 544	257,5 / 16	GIR	469 790	19,6	20 979
				16Z	▮ 478 065	277 / 16	GIR	469 790	19,6	20 979
2.1	2,1	64/68/ 70/82	08.85-07.92	FES	▮ 478 136	278 / 13	ATE	460 111	18,6	20 011
				FSB	▮ 478 224	258 / 16	GIR	469 790	19,6	20 979
2.1 Syncro	2,1	64/70/ 82	08.85-07.92	14Z	▮ 478 544	257,5 / 16	GIR	469 790	19,6	20 979
				16Z	▮ 478 065	277 / 16	GIR	469 790	19,6	20 979
T4 - California; Caravelle; Multivan; Transporter [70, 7D] 1.8	1,8	49	PR no. 1LA	12.90-07.92	▮ 478 547	260 / 16	GIR	460 941	19	20 124
			PR no. 1LB	12.90-07.92	▮ 478 296	313 / 26	ATE	424 777		23 269
					▮ 479 037	300 / 26	ATE	424 777		23 269
			PR no. 1LE	12.90-07.92	▮ 478 548	280 / 24	GIR, LUC	460 954	18,1	20 652
			PR no. 1LP	12.90-07.92	▮ 478 613	282 / 18	GIR	461 753	19	21 479
			PR no. 1LU	12.90-07.92	284		ATE	494 008	19,6	21 883
1.9 D	1,9	45	PR no. 1LA	09.90-04.97	▮ 478 547	260 / 16	GIR	460 941	19	20 124
			PR no. 1LB	09.90-04.97	▮ 478 296	313 / 26	ATE	424 777		23 269
					▮ 479 037	300 / 26				
			PR no. 1LE Fg.no. → 70...T...199 000	09.90-12.95	▮ 478 548	280 / 24	GIR, LUC	460 954	18,1	20 652
			PR no. 1LE; 1LU	01.96-04.97	▮ 478 846	280 / 24	ATE	494 008	19,6	21 883
			Fg.no. 70...T...200 001→							



				0 986...	0 986...	1 987...	1 987...			
◀ VW										
T4 - California;	1,9	45	PR no. 1LP	09.90-12.95	▮ 478 613	282 / 18	GIR	461 753	19	21 479
			Fg.no. →70..T..199 000							
Caravelle; Multivan;			PR no. 1LP	01.96-04.97	▮ 478 870	282 / 18	GIR	461 753	19	21 479
			Fg.no. 70..T..200 001→							
Transporter [70, 7D]	1,9 D		PR no. 1LA	10.92-06.03	▮ 478 547	260 / 16	GIR	460 941	19	20 124
			PR no. 1LB	10.92-06.03	▮ 478 296	313 / 26	ATE	424 777		23 269
					▮ 479 037	300 / 26				
			PR no. 1LE	10.92-12.95	▮ 478 548	280 / 24				
			Fg.no. →70..T..199 000							
			PR no. 1LE; 1LU	01.96-06.03	▮ 478 846	280 / 24				
			Fg.no. 70..T..200 001→							
			PR no. 1LE	10.92-04.99 284			GIR,	460 954	18,1	20 652
			Fg.no. →70..X..250 000				LUC			
			PR no. 1LE	05.99-06.03 284			LUC	494 041	18,1	23 176
			Fg.no. 70..Y..000 001→							
			PR no. 1LP	10.92-12.95	▮ 478 613	282 / 18				
			Fg.no. →70..T..199 000							
			PR no. 1LP	01.96-06.03	▮ 478 870	282 / 18				
			Fg.no. 70..T..200 001→							
			PR no. 1LP	10.92-04.99 281			GIR	461 753	19	21 479
			Fg.no. →70..X..250 000							
			PR no. 1LP	05.99-06.03 281			GIR	424 672	19	21 479
			Fg.no. 70..Y..000 001→							
			PR no. 1LU	10.92-04.99 284			ATE	494 008	19,6	21 883
			Fg.no. →70..X..250 000							
			PR no. 1LU	05.99-06.03 284			ATE	424 537	19,6	23 163
			Fg.no. 70..Y..000 001→							
2.0	2,0	62	PR no. 1LA	09.90-06.03	▮ 478 547	260 / 16	GIR	460 941	19	20 124
			PR no. 1LB	09.90-06.03	▮ 478 296	313 / 26	ATE	424 777		23 269
					▮ 479 037	300 / 26				
			PR no. 1LE	09.90-12.95	▮ 478 548	280 / 24				
			Fg.no. →70..T..199 000							
			PR no. 1LE; 1LU	01.96-06.03	▮ 478 846	280 / 24				
			Fg.no. 70..T..200 001→							
			PR no. 1LE	09.90-04.99 284			GIR,	460 954	18,1	20 652
			Fg.no. →70..X..250 000				LUC			
			PR no. 1LE	05.99-06.03 284			LUC	494 041	18,1	23 176
			Fg.no. 70..Y..000 001→							
			PR no. 1LP	09.90-12.95	▮ 478 613	282 / 18				
			Fg.no. →70..T..199 000							
			PR no. 1LP	01.96-06.03	▮ 478 870	282 / 18				
			Fg.no. 70..T..200 001→							
			PR no. 1LP	09.90-04.99 281			GIR	461 753	19	21 479
			Fg.no. →70..X..250 000							
			PR no. 1LP	05.99-06.03 281			GIR	424 672	19	21 479
			Fg.no. 70..Y..000 001→							
			PR no. 1LU	09.90-04.99 284			ATE	494 008	19,6	21 883
			Fg.no. →70..X..250 000							
			PR no. 1LU	05.99-06.03 284			ATE	424 537	19,6	23 163
			Fg.no. 70..Y..000 001→							
2.0 D Syncro	2,4	57	PR no. 1LA	11.92-09.98	▮ 478 547	260 / 16	GIR	460 941	19	20 124
			PR no. 1LB	11.92-09.98	▮ 478 296	313 / 26	ATE	424 777		23 269
					▮ 479 037	300 / 26				
			PR no. 1LE	11.92-12.95	▮ 478 548	280 / 24	GIR,	460 954	18,1	20 652
			Fg.no. →70..T..199 000				LUC			
			PR no. 1LE	01.96-09.98	▮ 478 846	280 / 24	GIR,	460 954	18,1	20 652
			Fg.no. 70..T..200 001→				LUC			
			PR no. 1LP	11.92-12.95	▮ 478 613	282 / 18	GIR	461 753	19	21 479
			Fg.no. →70..T..199 000							
			PR no. 1LP	01.96-09.98	▮ 478 870	282 / 18	GIR	461 753	19	21 479
			Fg.no. 70..T..200 001→							
			PR no. 1LU	01.96-09.98	▮ 478 846	280 / 24				
			Fg.no. 70..T..200 001→							



					0 986...			0 986...			1 987...	1 987...
T4 - California;	2,4	57	PR no. 1LU	11.92-09.98			ATE	494 008	19,6	21 883		
Caravelle; Multivan;												
Transporter [70, 7D]												
2.0 D Syncro												
2.5	2,5	81	PR no. 1LA	11.90-06.03	▮ 478 547	260 / 16	GIR	460 941	19	20 124		
			PR no. 1LB	11.90-06.03	▮ 478 296	313 / 26	ATE	424 777		23 269		
					▮ 479 037	300 / 26						
			PR no. 1LE	11.90-12.93	▮ 478 548	280 / 24	GIR, LUC	460 954	18,1	20 652		
			PR no. 1LE	07.94-12.95	▮ 478 548	280 / 24	GIR, LUC	460 954	18,1	20 652		
			Fg.no. →70..T..199 000									
			PR no. 1LE	01.96-04.99	▮ 478 846	280 / 24	GIR, LUC	460 954	18,1	20 652		
			Fg.no. 70..T..200 001→									
			70..X..250 000									
			PR no. 1LE	05.99-06.03	▮ 478 846	280 / 24	LUC	494 041	18,1	23 176		
			Fg.no. 70..Y..000 001→									
			PR no. 1LP	11.90-12.93	▮ 478 613	282 / 18	GIR	461 753	19	21 479		
			PR no. 1LP	07.94-12.95	▮ 478 613	282 / 18	GIR	461 753	19	21 479		
			Fg.no. →70..T..199 000									
			PR no. 1LP	01.96-04.99	▮ 478 870	282 / 18	GIR	461 753	19	21 479		
			Fg.no. 70..T..200 001→									
			70..X..250 000									
			PR no. 1LP	05.99-06.03	▮ 478 870	282 / 18	GIR	424 672	19	21 479		
			Fg.no. 70..Y..000 001→									
			PR no. 1LU	11.90-12.93	284		ATE	494 008	19,6	21 883		
			PR no. 1LU	01.96-04.99	▮ 478 846	280 / 24	ATE	494 008	19,6	21 883		
			Fg.no. 70..T..200 001→									
			70..X..250 000									
			PR no. 1LU	05.99-06.03	▮ 478 846	280 / 24	ATE	424 537	19,6	23 163		
			Fg.no. 70..Y..000 001→									
		85	PR no. 1LA	08.96-06.03	▮ 478 547	260 / 16	GIR	460 941	19	20 124		
			PR no. 1LB	08.96-06.03	▮ 478 296	313 / 26	ATE	424 777		23 269		
					▮ 479 037	300 / 26						
			PR no. 1LE	08.96-04.99	▮ 478 846	280 / 24	GIR, LUC	460 954	18,1	20 652		
			Fg.no. →70..X..250 000									
			PR no. 1LE	05.99-06.03	▮ 478 846	280 / 24	LUC	494 041	18,1	23 176		
			Fg.no. 70..Y..000 001→									
			PR no. 1LP	08.96-04.99	▮ 478 870	282 / 18	GIR	461 753	19	21 479		
			Fg.no. →70..X..250 000									
			PR no. 1LP	05.99-06.03	▮ 478 870	282 / 18	GIR	424 672	19	21 479		
			Fg.no. 70..Y..000 001→									
			PR no. 1LU	08.96-04.99	▮ 478 846	280 / 24	ATE	494 008	19,6	21 883		
			Fg.no. →70..X..250 000									
			PR no. 1LU	05.99-06.03	▮ 478 846	280 / 24	ATE	424 537	19,6	23 163		
			Fg.no. 70..Y..000 001→									
2.5 Syncro	2,5	81	PR no. 1LA	11.92-10.96	▮ 478 547	260 / 16	GIR	460 941	19	20 124		
				06.97-11.01	▮ 478 547	260 / 16	GIR	460 941	19	20 124		
			PR no. 1LB	11.92-10.96	▮ 478 296	313 / 26	ATE	424 777		23 269		
					▮ 479 037	300 / 26						
				06.97-11.01	▮ 478 296	313 / 26	ATE	424 777		23 269		
					▮ 479 037	300 / 26						
			PR no. 1LE	11.92-12.93	▮ 478 548	280 / 24	GIR, LUC	460 954	18,1	20 652		
			PR no. 1LE	01.94-12.95	▮ 478 548	280 / 24	GIR, LUC	460 954	18,1	20 652		
			Fg.no. →70..T..199 000									
			PR no. 1LE	01.96-10.96	▮ 478 846	280 / 24	GIR, LUC	460 954	18,1	20 652		
			Fg.no. 70..T..200 001→									
			PR no. 1LE	06.97-04.99	▮ 478 846	280 / 24	GIR, LUC	460 954	18,1	20 652		
			Fg.no. →70..X..250 000									
			PR no. 1LE	05.99-11.01	▮ 478 846	280 / 24	LUC	494 041	18,1	23 176		
			Fg.no. 70..Y..000 001→									
			PR no. 1LP	11.92-12.93	▮ 478 613	282 / 18	GIR	461 753	19	21 479		



				0 986...	0 986...	1 987...	1 987...				
◀ VW											
T4 - California; Caravelle; Multivan; Transporter [70, 7D] 2.5 Syncro	2,5	81	PR no. 1LP	01.94-12.95	478 613	282 / 18	GIR	461 753	19	21 479	
			Fg.no. →70..T..199 000								
			PR no. 1LP	01.96-10.96	478 870	282 / 18	GIR	461 753	19	21 479	
			Fg.no. 70..T..200 001→								
			PR no. 1LP	06.97-04.99	478 870	282 / 18	GIR	461 753	19	21 479	
			Fg.no. →70..X..250 000								
			PR no. 1LP	05.99-11.01	478 870	282 / 18	GIR	424 672	19	21 479	
			Fg.no. 70..Y..000 001→								
			PR no. 1LU	11.92-10.96	284		ATE	494 008	19,6	21 883	
			PR no. 1LU	01.96-10.96	478 846	280 / 24					
			Fg.no. 70..T..200 001→								
			PR no. 1LU	06.97-04.99	478 846	280 / 24	ATE	494 008	19,6	21 883	
			Fg.no. →70..X..250 000								
			PR no. 1LU	05.99-11.01	478 846	280 / 24	ATE	424 537	19,6	23 163	
Fg.no. 70..Y..000 001→											
85			PR no. 1LA	08.96-06.03	478 547	260 / 16	GIR	460 941	19	20 124	
			PR no. 1LB	08.96-06.03	478 296	313 / 26	ATE	424 777		23 269	
					479 037	300 / 26					
			PR no. 1LE	08.96-04.99	478 846	280 / 24	GIR,	460 954	18,1	20 652	
			Fg.no. →70..X..250 000				LUC				
			PR no. 1LE	05.99-06.03	478 846	280 / 24	LUC	494 041	18,1	23 176	
			Fg.no. 70..Y..000 001→								
			PR no. 1LP	08.96-04.99	478 870	282 / 18	GIR	461 753	19	21 479	
			Fg.no. →70..X..250 000								
			PR no. 1LP	05.99-06.03	478 870	282 / 18	GIR	424 672	19	21 479	
			Fg.no. 70..Y..000 001→								
			PR no. 1LU	08.96-04.99	478 846	280 / 24	ATE	494 008	19,6	21 883	
			Fg.no. →70..X..250 000								
			PR no. 1LU	05.99-06.03	478 846	280 / 24	ATE	424 537	19,6	23 163	
Fg.no. 70..Y..000 001→											
2.5 TDI	2,5	65/75/ 111	PR no. 1LA	05.98-06.03	478 547	260 / 16	GIR	460 941	19	20 124	
			PR no. 1LB	05.98-06.03	478 296	313 / 26	ATE	424 777		23 269	
					479 037	300 / 26					
			PR no. 1LE	05.98-04.99	478 846	280 / 24	GIR,	460 954	18,1	20 652	
			Fg.no. →70..X..250 000				LUC				
			PR no. 1LE	05.99-06.03	478 846	280 / 24	LUC	494 041	18,1	23 176	
			Fg.no. 70..Y..000 001→								
			PR no. 1LP	05.98-04.99	478 870	282 / 18	GIR	461 753	19	21 479	
			Fg.no. →70..X..250 000								
			PR no. 1LP	05.99-06.03	478 870	282 / 18	GIR	424 672	19	21 479	
			Fg.no. 70..Y..000 001→								
			PR no. 1LU	05.98-04.99	478 846	280 / 24	ATE	494 008	19,6	21 883	
			Fg.no. →70..X..250 000								
			PR no. 1LU	05.99-06.03	478 846	280 / 24	ATE	424 537	19,6	23 163	
Fg.no. 70..Y..000 001→											
2.5 TDI Syncro	2,5	75	PR no. 1LA	03.98-06.03	478 547	260 / 16	GIR	460 941	19	20 124	
			PR no. 1LB	03.98-06.03	478 296	313 / 26	ATE	424 777		23 269	
					479 037	300 / 26					
			PR no. 1LE	03.98-04.99	478 846	280 / 24	GIR,	460 954	18,1	20 652	
			Fg.no. →70..X..250 000				LUC				
			PR no. 1LE	05.99-06.03	478 846	280 / 24	LUC	494 041	18,1	23 176	
			Fg.no. 70..Y..000 001→								
			PR no. 1LP	03.98-04.99	478 870	282 / 18	GIR	461 753	19	21 479	
			Fg.no. →70..X..250 000								
			PR no. 1LP	05.99-06.03	478 870	282 / 18	GIR	424 672	19	21 479	
			Fg.no. 70..Y..000 001→								
			PR no. 1LU	03.98-04.99	478 846	280 / 24	ATE	494 008	19,6	21 883	
			Fg.no. →70..X..250 000								
			PR no. 1LU	05.99-06.03	478 846	280 / 24	ATE	424 537	19,6	23 163	
Fg.no. 70..Y..000 001→											
2.8	2,8	103	PR no. 1LA	05.96-05.00	478 547	260 / 16	GIR	460 941	19	20 124	
			PR no. 1LB	05.96-05.00	478 296	313 / 26	ATE	424 777		23 269	
					479 037	300 / 26					



					0 986...	0 986...					1 987...	1 987...	
T4 - California; Caravelle; Multivan; Transporter [70, 7D] 2.8	2,8	103	PR no. 1LE Fg.no. →70..X..250 000	05.96-04.99	▮ 478 846	280 / 24	GIR, LUC	460 954	18,1	20 652			
			PR no. 1LE Fg.no. 70..Y..000 001→	05.99-05.00	▮ 478 846	280 / 24	LUC	494 041	18,1	23 176			
			PR no. 1LP Fg.no. →70..X..250 000	05.96-04.99	▮ 478 870	282 / 18	GIR	461 753	19	21 479			
			PR no. 1LP Fg.no. 70..Y..000 001→	05.99-05.00	▮ 478 870	282 / 18	GIR	424 672	19	21 479			
			PR no. 1LU Fg.no. →70..X..250 000	05.96-04.99	▮ 478 846	280 / 24	ATE	494 008	19,6	21 883			
			PR no. 1LU Fg.no. 70..Y..000 001→	05.99-05.00	▮ 478 846	280 / 24	ATE	424 537	19,6	23 163			
		150	PR no. 1LA	05.00-06.03	▮ 478 547	260 / 16	GIR	460 941	19	20 124			
			PR no. 1LB	05.00-06.03	▮ 478 296	313 / 26	ATE	424 777		23 269			
					▮ 479 037	300 / 26							
			PR no. 1LE	05.00-06.03	▮ 478 846	280 / 24	LUC	494 041	18,1	23 176			
		PR no. 1LP	05.00-06.03	▮ 478 870	282 / 18	GIR	424 672	19	21 479				
		PR no. 1LU	05.00-06.03	▮ 478 846	280 / 24	ATE	424 537	19,6	23 163				
T5 - California; Caravelle; Multivan; Transporter [7H] 1.9 TDI 2.0 2.5 TDI 2.5 TDI 4 Motion 3.2 3.2 4 Motion [7J] 1.9 TDI 2.0 2.5 TDI 2.5 TDI 4 Motion 3.2 3.2 4 Motion	1,9	62/75		01.06→	▮ 479 211	308 / 29,5	MVB	494 107	17,9	23 749			
					▮ 479 096	333 / 32,5	MVB	494 107	17,9	23 749			
		63/77		04.03→	▮ 479 211	308 / 29,5	MVB	494 107	17,9	23 749			
					▮ 479 096	333 / 32,5	MVB	494 107	17,9	23 749			
	2.0	2,0	85		06.03→	▮ 479 211	308 / 29,5	MVB	494 107	17,9	23 749		
						▮ 479 096	333 / 32,5	MVB	494 107	17,9	23 749		
	2.5 TDI	2,5	96/120/ 128		02.03→	▮ 479 211	308 / 29,5	MVB	494 107	17,9	23 749		
						▮ 479 096	333 / 32,5	MVB	494 107	17,9	23 749		
	2.5 TDI 4 Motion	2,5	96/128		07.04→	▮ 479 211	308 / 29,5	MVB	494 107	17,9	23 749		
						▮ 479 096	333 / 32,5	MVB	494 107	17,9	23 749		
	3.2	3,2	170		02.03-06.04	▮ 479 211	308 / 29,5	MVB	494 107	17,9	23 749		
						▮ 479 096	333 / 32,5	MVB	494 107	17,9	23 749		
			173		05.03→	▮ 479 211	308 / 29,5	MVB	494 107	17,9	23 749		
						▮ 479 096	333 / 32,5	MVB	494 107	17,9	23 749		
	3.2 4 Motion	3,2	173		07.04→	▮ 479 211	308 / 29,5	MVB	494 107	17,9	23 749		
						▮ 479 096	333 / 32,5	MVB	494 107	17,9	23 749		
[7J] 1.9 TDI	1,9	62/75		06.06→	▮ 479 211	308 / 29,5	MVB	494 107	17,9	23 749			
					▮ 479 096	333 / 32,5	MVB	494 107	17,9	23 749			
		63/77		04.03→	▮ 479 211	308 / 29,5	MVB	494 107	17,9	23 749			
					▮ 479 096	333 / 32,5	MVB	494 107	17,9	23 749			
2.0	2,0	85		06.03→	▮ 479 211	308 / 29,5	MVB	494 107	17,9	23 749			
					▮ 479 096	333 / 32,5	MVB	494 107	17,9	23 749			
2.5 TDI	2,5	96/128		04.03→	▮ 479 211	308 / 29,5	MVB	494 107	17,9	23 749			
					▮ 479 096	333 / 32,5	MVB	494 107	17,9	23 749			
2.5 TDI 4 Motion	2,5	96/128		07.04→	▮ 479 211	308 / 29,5	MVB	494 107	17,9	23 749			
					▮ 479 096	333 / 32,5	MVB	494 107	17,9	23 749			
3.2	3,2	170		02.04→	▮ 479 211	308 / 29,5	MVB	494 107	17,9	23 749			
					▮ 479 096	333 / 32,5	MVB	494 107	17,9	23 749			
3.2 4 Motion	3,2	170		07.04→	▮ 479 211	308 / 29,5	MVB	494 107	17,9	23 749			
					▮ 479 096	333 / 32,5	MVB	494 107	17,9	23 749			





ALFA ROMEO

AR 8 35	2,5	53		01.83-12.89	
40	2,5	53		01.83-12.88	

AUSTIN

Maestro 500/700 1.3 City L	1,3	45	Fg.no. →(V) 367394	09.84-01.86	
			Fg.no. (V) 367395→	01.86-08.88	
	50		Fg.no. →(V) 367394	09.84-01.86	
			Fg.no. (V) 367395→	01.86-08.88	
1.6 City L	1,6	63	Fg.no. →(V) 367394	09.84-01.86	
			Fg.no. (V) 367395→	01.86-08.88	
2.0 City L	2,0	45	Fg.no. →(V) 367394	09.84-01.86	
			Fg.no. (V) 367395→	01.86-08.88	
Metro 310 1.0 City L	1,0	50	Fg.no. XF 400202→XF 944211	08.83-08.88	MGN
			Fg.no. 300000→145347	08.83-08.88	
	54		Fg.no. XF 400202→XF 944211	08.83-08.88	MGN
			Fg.no. 300000→145347	08.83-08.88	
310 1.3 City L	1,3	68	Fg.no. XF 400202→XF 944211	08.83-08.88	MGN
			Fg.no. 300000→145347	08.83-08.88	
	72		Fg.no. XF 400202→XF 944211	08.83-08.88	MGN
			Fg.no. 300000→145347	08.83-08.88	

BEDFORD

Astra 1.3	1,3	54		08.84-10.89		
				Fg.no. MB535155→	08.84-10.89	ABO,GS, LIM
1.4	1,4	55		09.89-09.91	ERH	
				Fg.no. MB535155→	09.89-09.91	ABO,GS, LIM
1.6	1,6	60		08.84-09.91	LIM	
1.6 D	1,6	39		08.84-12.88	ERH	
				Fg.no. →G5184469	08.84-12.88	LIM
				Fg.no. G5184470→	08.84-12.88	ABO,LIM
1.7 D	1,7	42		01.89-09.91	ERH LIM	
Astramax 1.3	1,3	54		08.84-10.89		
				Fg.no. MB535155→	08.84-10.89	ABO,GS, LIM
1.6	1,6	60		09.85-09.93	LIM	
1.6 D	1,6	39		08.84-12.88	ERH	
				Fg.no. →G5184469	08.84-12.88	LIM
				Fg.no. G5184470→	08.84-12.88	ABO,LIM
1.7 D	1,7	42		01.89-09.93	KOB,KW LIM	
Brava Pickup 2.2 D	2,2	38		12.88-06.94		
2.3	2,3	65		12.88-06.94		
CF-Serie 2/230	2,0	57		05.84-07.87		
	2,3	45		05.84-07.87		
2/250	2,0	57		05.84-07.87		
	2,3	45		05.84-07.87		





◀ BEDFORD

CF-Serie 2/280	2,0	57	05.84-07.87
	2,3	45	05.84-07.87
2/350	2,0	57	05.84-07.87
	2,3	45	05.84-07.87
Chevonne 1.3	1,3	40	09.80-08.82
K-Serie B	1,6	52	04.84-01.88
	2,0	34	04.84-01.88
Rascal 99170, 99180	1,0	34	02.86-06.93

CHEVROLET

Corsa Pick-Up 1.7 D	1,7	44	12.95-02.03	ABO,NAB
				ABS,NAB, NAR
S10 2.2 EFI	2,2	83	03.95-10.98	
2.2 MPFI	2,2	100	08.97-04.00	
2.8 D	2,8	97	03.01-07.05	
4.3 V6 MPFI	4,3	132	08.96-10.03	

CITROEN

Berlingo 1.8 i	1,8	74	10.99-12.03				
Berlingo [B9] 1.6 HDi	1,6	55	05.08→		0986 479 383	267/12	
				BSM	0986 479 387	267/12	
			66	05.08→	0986 479 383	267/12	
				BSM	0986 479 387	267/12	
			80	05.08→	0986 479 383	267/12	
			BSM	0986 479 387	267/12		
1.6 i 16V	1,6	66	05.08→		0986 479 383	267/12	
				BSM	0986 479 387	267/12	
			80	05.08→	0986 479 383	267/12	
				BSM	0986 479 387	267/12	
				BSM	0986 479 387	267/12	
Berlingo [M49] Electrique		24	10.98-11.02				
1.1 i	1,1	44	07.96-11.02				
			06.00-11.02				
1.4	1,4	51	10.96-11.02				
1.4 i	1,4	55	07.96-11.02				
			06.00-11.02				
1.6 i 16V	1,6	80	06.00-11.02				
1.8 D	1,8	43-44	07.96-11.02				
1.8 i	1,8	66	03.97-11.02				
1.9 D	1,9	50-51	07.96-11.02				
		52	07.98-11.02				
			09.00-11.02				
2.0 HDi	2,0	66	12.99-11.02				
Berlingo [M59] Electrique		28	11.02→				
1.1 i	1,1	44	11.02→				
1.4 i	1,4	55	11.02→				
1.6 HDi	1,6	55	09.05→				
		66	09.05→	0986 478 608	246,7/9	GIR	0986 461 769 20961
1.6 i 16V	1,6	80	11.02→	0986 478 608	246,7/9	GIR	0986 461 769 20961
1.9 D	1,9	52	11.02→				
2.0 HDi	2,0	66	11.02→	0986 478 608	246,7/9	GIR	0986 461 769 20961
C 25 E 1.8	1,8	49-51	11.81-03.94				
				D27			
				L02,L03			
		Org.no. →73501	11.81-03.94	D22			
		Org.no. 73502→	11.81-03.94	D25			





◀ CITROEN

C	25 E 2.0	2,0	55-63	09.81-03.94	D27				
					L02,L03				
				Org.no. →73501	09.81-03.94	D22			
				Org.no. 73502→	09.81-03.94	D25			
	25 1.9 D	1,9	51	07.87-03.94					
						D27			
						L02,L03			
				Org.no. →73501	07.87-03.94	D22			
				Org.no. 73502→	07.87-03.94	D25			
	25 1.9 D Turbo	1,9	60	04.92-03.94					
						D27			
						L02,L03			
				Org.no. →73501	04.92-03.94	D22			
				Org.no. 73502→	04.92-03.94	D25			
	25 2.5 D	2,5	54-55	07.81-03.94					
						D27			
						L02,L03			
				Org.no. →73501	07.81-03.94	D22			
				Org.no. 73502→	07.81-03.94	D25			
	25 2.5 D Turbo	2,5	70	08.87-03.94					
						D27			
						L02,L03			
				Org.no. →73501	08.87-03.94	D22			
				Org.no. 73502→	08.87-03.94	D25			
	35 2.5 D	2,5	50	01.80-04.84				BSY	0986 424 026 20 288
				01.80-12.92			0986 478 741 279/9		
						D27			
				Org.no. →73501	01.80-12.92	D22			
				Org.no. 73502→	01.80-12.92	D25			
	45 2.5 D	2,5	50	06.82-12.92					
						D27			
				Org.no. →73501	06.82-12.92	D22			
				Org.no. 73502→	06.82-12.92	D25			
C 15	E 1.0	1,0	32	11.86-12.97					
					4LO				
				Org.no. 4196→	06.88-07.88	4LO			
	E 1.1	1,1	35	10.84-07.87					
			35-40	07.87-07.88					
						4LO			
			44	07.88-12.96					
						4LO			
	E 1.1 i	1,1	44	06.89-12.96					
						4LO			
	E 1.3	1,3	47	07.87-07.88					
						4LO			
	E 1.4	1,4	40-46	07.87-12.96					
						4LO			
				Org.no. 4196→	06.88-12.96	4LO			
			44	07.86-07.87					
			50-51	07.86-07.87					
			51	07.87-12.96					
				Org.no. 4196→	06.88-12.96	4LO			
			55	05.91-12.96					
						4LO			
	E 1.4 i	1,4	55-58	01.92-12.96					
						4LO			
	1.8 D	1,8	44	07.86-05.00					
						4LO			
	1.9 D	1,9	52	06.00-12.05					
	Jumper 2.8	2,8	63	01.02-08.05				BRB	0986 494 049 23 921
						L02			
						L03	0986 479 065 280/16		



◀ CITROEN

Jumper 2.8 HDi	2,8	93	09.05→				BRB	0 986 494 049	23 921
				L02					
				L03	0 986 479 065	280 / 16			
2.8 T	2,8	77	12.01-08.05				BRB	0 986 494 049	23 921
				L02					
				L03	0 986 479 065	280 / 16			
Jumper [U5] 2.0 HDi	2,0	62	02.02→				BRB	0 986 494 049	23 921
				L02	0 986 479 066	280 / 16			
				L03	0 986 479 065	280 / 16			
2.0 i	2,0	80	02.02→				BRB	0 986 494 049	23 921
				L02	0 986 479 066	280 / 16			
				L03	0 986 479 065	280 / 16			
2.2 HDi	2,2	74	02.02→				BRB	0 986 494 049	23 921
				L02	0 986 479 066	280 / 16			
				L03	0 986 479 065	280 / 16			
2.8 D Turbo	2,8	90	02.02→				BRB	0 986 494 049	23 921
				L02	0 986 479 066	280 / 16			
				L03	0 986 479 065	280 / 16			
2.8 HDi	2,8	94	02.02→				BRB	0 986 494 049	23 921
				L02	0 986 479 066	280 / 16			
				L03	0 986 479 065	280 / 16			
		107	08.04→				BRB	0 986 494 049	23 921
				L02	0 986 479 066	280 / 16			
				L03	0 986 479 065	280 / 16			
Jumper [U9] 2.2 HDi	2,2	74	06.06→		0 986 479 399	280 / 16			
					0 986 479 317	300 / 16			
					0 986 479 316	280 / 16	BSY	0 986 494 110	24465
				MTS					
		88	06.06→		0 986 479 399	280 / 16			
					0 986 479 317	300 / 16			
					0 986 479 316	280 / 16	BSY	0 986 494 110	24465
				MTS					
3.0 HDi	3,0	115	06.06→		0 986 479 399	280 / 16			
					0 986 479 317	300 / 16			
					0 986 479 316	280 / 16	BSY	0 986 494 110	24465
				MTS					
Jumper [23] 1.9 D	1,9	51	02.94-02.02	D25,L03					
				D27,L03					
				L02					
				L03					
			01.99-02.02	D25,L03					
				D27,L03					
				L02					
				L03					
1.9 D Turbo	1,9	66-68	02.94-02.02	D25,L03					
				D27,L03					
				L02					
				L03					





◀ CITROEN

Jumper [23] 2.0	2,0	79	02.94-02.02	D25,L03 D27,L03 L02 L03		
2.0 HDi	2,0	62	03.01-02.02	D25,L03 D27,L03 L02 L03		
2.0 i	2,0	80	02.94-02.02	D25,L03 D27,L03 L02 L03		
2.5 D	2,5	63	02.94-02.02	D25,L03 D27,L03 L02 L03		
2.5 D Turbo	2,5	76	02.94-02.02	D25,L03 D27,L03 L02 L03		
2.5 TDi	2,5	79	10.96-02.02	D25,L03 D27,L03 L02 L03		
2.8 D	2,8	64	01.99-02.02	D25,L03 D27,L03 L02 L03		
2.8 D Turbo	2,8	90	10.99-02.02	D25,L03 D27,L03 L02 L03		
2.8 HDi	2,8	94	09.00-02.02	D25,L03 D27,L03 L02 L03		
Jumpy [G9] 1.6 HDi	1,6	66	02.07→		0986 479 379	290 / 14
2.0 HDi	2,0	88	02.07→		0986 479 379	290 / 14
		100	02.07→		0986 479 379	290 / 14
2.0 i 16V	2,0	103	02.07→		0986 479 379	290 / 14
Jumpy [U64] 1.6 i	1,6	58	10.95→			
1.9 D	1,9	50-52	10.95→			
		51	10.98-08.01			
		52	09.01→			
1.9 D Turbo	1,9	66	10.95→			
		67-68	10.95→			
2.0 HDi	2,0	70	10.99→			
		80	10.99→			
		81	06.00→			
2.0 i	2,0	100	04.00→			
Nemo [A9] 1.4 HDi	1,4	50	02.08→			
1.4 i	1,4	54	02.08→			

DACIA

Duster 1.4 4WD 1,4 06.84-12.98 ZUB

EBRO (MISA)

Trade 2.0 2,0 41-44 09.84-02.87
2.8 2,8 56 05.85-02.87



FIAT

Cityvan [257..] 1.1	1,1	43	01.85-08.89					
1.7 D	1,7	44	01.85-08.89					
Doblo Cargo [223..]	1,2	47	07.00-09.05					
1.2 i.e. 8V								
1.3 JTD	1,2	55	10.05→					
		62	10.05→					
1.3 JTD 16V	1,2	51	02.04-09.05					
1.4 i.e.	1,4	57	10.05→					
1.6 i.e. 16V	1,6	76	10.01-09.05					
1.6 i.e. 16V Bipower	1,6	68-76	01.03-09.05					
		76	10.05→					
1.9 D	1,9	46	07.00-09.05					
1.9 JTD	1,9	74	10.01-01.04					
			10.05→					
		77	11.02-09.05					
			10.05→					
		88	10.05→					
Ducato 2.5 D	2,5	62	11.97-05.05					
2.8 D	2,8	63	04.00-05.05					
2.8 D Turbo	2,8	90	04.00-05.05	0986 479 065	280 / 16			
			05.02-05.05	0986 479 065	280 / 16	BRB	0986 494 049	23 921
			MTS					
2.8 D Turbo Interc.	2,8	103,3	10.00-05.05	0986 479 065	280 / 16			
			05.02-05.05			BRB	0986 494 049	23 921
			MTS					
2.8 JTD Combinato	2,8	93	06.05→	0986 479 065	280 / 16			
				MTS				
2.8 JTD Maxi Cargo	2,8	93	06.05→	0986 479 066	280 / 16			
				MTS				
2.8 JTD Minibus	2,8	93	06.05→	0986 479 065	280 / 16			
				MTS				
2.8 JTD Multi T.A.	2,8	93	06.05→	0986 479 066	280 / 16			
				MTS				
2.8 JTD Multi T.B.	2,8	93	06.05→	0986 479 065	280 / 16			
				MTS				
Ducato Cargo 2.5 D	2,5	62	11.97-05.05					
2.8 D	2,8	63	04.00-05.05					
			01.04-05.05	0986 479 065	280 / 16	BRB	0986 494 049	23 921
			MTS					
2.8 D Turbo	2,8	90	04.00-05.05	0986 479 066	280 / 16			
			05.02-05.05			BRB	0986 494 049	23 921
			MTS					
			01.04-05.05	0986 479 066	280 / 16	BRB	0986 494 049	23 921
			MTS					
2.8 D Turbo Interc.	2,8	103,3	10.00-05.05	0986 479 066	280 / 16			
			05.02-05.05			BRB	0986 494 049	23 921
			MTS					
2.8 JTD	2,8	93	06.05→	0986 479 065	280 / 16			
				MTS				
Ducato Maxi 17 [251..]	2,3	88	06.06→	ALU	0986 479 066	280 / 16	BSY	0986 494 110 24465
2.3 JTD				MTS				
				SSR	0986 479 316	280 / 16		
		96	06.06→	ALU	0986 479 066	280 / 16	BSY	0986 494 110 24465
				MTS				
				SSR	0986 479 316	280 / 16		
3.0 JTD	3,0	116	06.06→	ALU	0986 479 066	280 / 16	BSY	0986 494 110 24465
				MTS				
				SSR	0986 479 316	280 / 16		





◀ FIAT

Ducato Maxi 20 [251..]	2,3	88	06.06→	ALU	0986 479 317	300/16	BSY	0986 494 110	24465
2.3 JTD				MTS					
		96	06.06→	SSR	0986 479 317	300/16			
				ALU	0986 479 317	300/16	BSY	0986 494 110	24465
				MTS					
				SSR	0986 479 317	300/16			
3.0 JTD	3,0	116	06.06→	ALU	0986 479 317	300/16	BSY	0986 494 110	24465
				MTS					
				SSR	0986 479 317	300/16			
Ducato 10 [230..] 1.9D	1,9	50	04.98-10.01						
		51	03.94-03.98						
1.9 TD	1,9	60	03.94-03.98						
		66	04.98-10.01						
1.9 TD CAT	1,9	59	03.94-03.98						
2.0	2,0	79	03.94-03.02						
2.0 i.e.	2,0	80	03.94-03.02						
2.0 JTD	2,0	63	10.01-03.02						
2.5 D	2,5	62	03.94-03.98						
2.5 TD ECO	2,5	80	03.94-03.98						
2.5 TD EGR	2,5	85	03.94-03.98						
2.8 D	2,8	64	04.98-03.02						
2.8 JTD	2,8	94	08.00-03.02						
2.8 JTD EGR	2,8	94	08.00-03.02						
2.8 TD	2,8	90	10.97-03.02						
2.8 TD EGR	2,8	90	10.97-03.02						
Ducato 10 [234..]	2,0	80	03.94-03.02						
2.0 i.e. Bipower CNG 4x4									
2.5 TD EGR 4x4	2,5	85	03.94-03.98						
2.5 TD 4x4	2,5	85	03.94-03.98						
2.8 JTD EGR 4x4	2,8	94	08.00-03.02						
2.8 JTD 4x4	2,8	94	08.00-03.02						
2.8 TD EGR 4x4	2,8	90	10.97-03.02						
2.8 TD 4x4	2,8	90	10.97-03.02						
Ducato 10 [279..] 1.9D	1,9	52	07.90-02.94						
1.9 TD	1,9	60	07.90-02.94						
2.0	2,0	55	07.90-02.94						
		63	07.90-02.94						
2.5 TD	2,5	70	07.90-02.94						
Ducato 10 [280..] 1.8	1,8	49-51	09.81-05.85						
			06.85-06.90						
			Ricam.no VETT.77161→						
1.9 D	1,9	52	02.87-06.90						
1.9 TD	1,9	60	02.87-06.90						
2.0	2,0	55	06.85-12.85						
			Ricam.no VETT.77161→						
		57	09.81-05.85						
			Ricam.no VETT.77161→						
		63	06.88-06.90						
2.5 D	2,5	53	05.81-12.85						
			Ricam.no VETT.77161→						
		54-55	05.81-12.85						
			01.86-06.90						
			Ricam.no VETT.77161→						
		55	01.86-06.90						





◀ FIAT

Ducato 11 [243..]	2.0 i.e.	2,0	81	04.02-08.06							
					SSR	0986 479 065	280 / 16			BRB	0986 494 049 23 921
				Fg.no. 7477799→	04.02-08.06	MTS					
2.0 JTD		2,0	62	04.02-08.06						BRB	0986 494 049 23 921
						SSR	0986 479 065	280 / 16			
				Fg.no. 7477799→	04.02-08.06	MTS					
2.3 JTD		2,3	81	04.02-08.06						BRB	0986 494 049 23 921
						SSR	0986 479 065	280 / 16			
				01.08→							
				Fg.no. 7477799→	04.02-08.06	MTS					
2.3 JTD EGR		2,3	81	04.02-08.06						BRB	0986 494 049 23 921
						SSR	0986 479 065	280 / 16			
				Fg.no. 7477799→	04.02-08.06	MTS					
2.8 JTD		2,8	94	04.02-08.06						BRB	0986 494 049 23 921
						SSR	0986 479 065	280 / 16			
				Fg.no. 7477799→	04.02-08.06	MTS					
2.8 JTD EGR		2,8	94	04.02-08.06						BRB	0986 494 049 23 921
						SSR	0986 479 065	280 / 16			
				Fg.no. 7477799→	04.02-08.06	MTS					
2.8 TD		2,8	90	10.02-08.06						BRB	0986 494 049 23 921
						SSR	0986 479 065	280 / 16			
				Fg.no. 7477799→	10.02-08.06	MTS					
2.8 TD EGR		2,8	90	10.02-08.06						BRB	0986 494 049 23 921
						SSR	0986 479 065	280 / 16			
				Fg.no. 7477799→	10.02-08.06	MTS					
Ducato 11 [247..]	2.0 i.e. 4x4	2,0	81	04.02-08.06						BRB	0986 494 049 23 921
						SSR	0986 479 065	280 / 16			
2.8 JTD EGR 4x4		2,8	94	04.02-08.06						BRB	0986 494 049 23 921
						SSR	0986 479 065	280 / 16			
2.8 JTD 4x4		2,8	94	04.02-08.06						BRB	0986 494 049 23 921
						MTS					
				Fg.no. →7314426	04.02-08.06	MTS					
2.8 TD EGR 4x4		2,8	90	10.02-08.06						BRB	0986 494 049 23 921
						SSR	0986 479 065	280 / 16			
Ducato 11 [250..]	2.2 JTD	2,2	74	06.06→		ALU	0986 479 399	280 / 16		BSY	0986 494 110 24465
						MTS					
						SSR	0986 479 399	280 / 16			
2.3 JTD		2,3	88	06.06→		ALU	0986 479 399	280 / 16		BSY	0986 494 110 24465
						MTS					
						SSR	0986 479 399	280 / 16			
			96	06.06→		ALU	0986 479 399	280 / 16		BSY	0986 494 110 24465
						MTS					
						SSR	0986 479 399	280 / 16			
3.0 JTD		3,0	116	06.06→		ALU	0986 479 399	280 / 16		BSY	0986 494 110 24465
						MTS					
						SSR	0986 479 399	280 / 16			
Ducato 12 [284..]	2.0 4x4	2,0	63	07.90-02.94							
2.5 D 4x4		2,5	55	07.90-02.94							
2.5 TD 4x4		2,5	70	07.90-02.94							





◀ FIAT

Ducato 13 [280..] 2.0	2,0	55	06.85-12.85	
			Ricam.no VETT.77161→	06.85-12.85
		57		09.81-05.85
			Ricam.no VETT.77161→	09.81-05.85
2.5 D	2,5	53	05.81-12.85	
			Ricam.no VETT.77161→	05.81-12.85
Ducato 14 [231..] 1.9 TD	1,9	60	03.94-03.98	
		66	04.98-10.01	
1.9 TD CAT	1,9	59	03.94-03.98	
2.0	2,0	79	03.94-03.02	
2.0 i.e.	2,0	80	03.94-03.02	
2.0 JTD	2,0	63	10.01-03.02	
2.5 D	2,5	62	03.94-03.98	
2.5 TD	2,5	85	03.94-03.98	
				D25
				D27
2.5 TD ECO	2,5	80	03.94-03.98	
				D25
				D27
2.5 TD EGR	2,5	85	03.94-03.98	
				D25
				D27
2.8 D	2,8	64	04.98-03.02	
2.8 JTD	2,8	94	08.00-03.02	
2.8 JTD EGR	2,8	94	08.00-03.02	
2.8 TD	2,8	90	10.97-03.02	
2.8 TD EGR	2,8	90	10.97-03.02	
Ducato 14 [234..]	2,0	80	03.94-03.02	
2.0 i.e. Bipower CNG 4x4				
2.5 TD ECO 4x4	2,5	80	03.94-03.98	
				D25
				D27
2.5 TD EGR 4x4	2,5	85	03.94-03.98	
				D25
				D27
2.8 JTD EGR 4x4	2,8	94	08.00-03.02	
2.8 JTD 4x4	2,8	94	08.00-03.02	
2.8 TD EGR 4x4	2,8	90	10.97-03.02	
2.8 TD 4x4	2,8	90	10.97-03.02	
Ducato 14 [280..] 1.9 TD	1,9	60	02.87-06.90	
			07.90-02.94	
2.0	2,0	55	01.86-06.90	
			07.90-02.94	
		63	06.88-06.90	
			07.90-02.94	
2.5 D	2,5	55	01.86-02.94	
2.5 D 4x4	2,5	55	01.89-06.90	
				WW
2.5 TD	2,5	68	01.86-06.90	
		70	07.90-02.94	
				WW
2.5 TD 4x4	2,5	68	01.89-06.90	





◀ FIAT

Ducato 15 [250..]	2.3 JTD	2,3	88	06.06→	ALU	0 986 479 399	280 / 16	BSY	0 986 494 110	24465
					MTS					
					SSR	0 986 479 399	280 / 16			
			96	06.06→	ALU	0 986 479 399	280 / 16	BSY	0 986 494 110	24465
					MTS					
					SSR	0 986 479 399	280 / 16			
	3.0 JTD	3,0	116	06.06→	ALU	0 986 479 399	280 / 16	BSY	0 986 494 110	24465
					MTS					
					SSR	0 986 479 399	280 / 16			
Ducato 17 [250..]	2.2 JTD	2,2	74	06.06→	ALU	0 986 479 399	280 / 16	BSY	0 986 494 110	24465
					MTS					
					SSR	0 986 479 399	280 / 16			
	2.3 JTD	2,3	88	06.06→	ALU	0 986 479 399	280 / 16	BSY	0 986 494 110	24465
					MTS					
					SSR	0 986 479 399	280 / 16			
			96	06.06→	ALU	0 986 479 399	280 / 16	BSY	0 986 494 110	24465
					MTS					
					SSR	0 986 479 399	280 / 16			
	3.0 JTD	3,0	116	06.06→	ALU	0 986 479 399	280 / 16	BSY	0 986 494 110	24465
					MTS					
					SSR	0 986 479 399	280 / 16			
Ducato 18 [232..]	2.0 i.e. Bipower CNG	2,0	80	03.94-03.02						
	2.5 D	2,5	62	03.94-03.98						
	2.5 TD	2,5	85	03.94-03.98						
	2.5 TD ECO	2,5	80	03.94-03.98						
	2.8 D	2,8	64	04.98-03.02						
	2.8 JTD	2,8	94	08.00-03.02						
	2.8 JTD EGR	2,8	94	08.00-03.02						
	2.8 TD	2,8	90	10.97-03.02						
	2.8 TD EGR	2,8	90	10.97-03.02						
Ducato 18 [234..]	2.5 D 4x4	2,5	62	03.94-03.98						
	2.5 TD 4x4	2,5	85	03.94-03.98						
	2.8 D 4x4	2,8	64	04.98-03.02						
	2.8 JTD EGR 4x4	2,8	94	08.00-03.02						
	2.8 JTD 4x4	2,8	94	08.00-03.02						
	2.8 TD EGR 4x4	2,8	90	10.97-03.02						
	2.8 TD 4x4	2,8	90	10.97-03.02						
Ducato 18 [245..]	2.0 i.e. Bipower CNG	2,0	81	04.02-08.06				BRB	0 986 494 049	23921
					SSR	0 986 479 066	280 / 16			
				Fg.no. 7477799→	04.02-08.06	MTS				
		2,0	71-81	04.02-08.06				BRB	0 986 494 049	23921
					SSR	0 986 479 066	280 / 16			
				Fg.no. 7477799→	04.02-08.06	MTS				
	2.3 JTD	2,3	81	04.02-08.06				BRB	0 986 494 049	23921
					SSR	0 986 479 066	280 / 16			
				01.08→				BRB	0 986 494 049	23921
					SSR	0 986 479 066	280 / 16			
				Fg.no. 7477799→	04.02-08.06	MTS				
				Fg.no. 7477799→	04.02-08.06	MTS				
	2.3 JTD EGR	2,3	81	01.08→				BRB	0 986 494 049	23921
					SSR	0 986 479 066	280 / 16			





◀ FIAT

Ducato 18 [245..]	2.8	94	04.02-08.06					
				SSR	0986 479 066	280 / 16	BRB	0986 494 049 23921
			Fg.no. 747779→	04.02-08.06	MTS			
			Fg.no. 7477799→	04.02-08.06	MTS			
2.8 JTD CGV	2.8	107	04.04-08.06					
				SSR	0986 479 066	280 / 16	BRB	0986 494 049 23921
			Fg.no. 747779→	04.04-08.06	MTS			
			Fg.no. 7477799→	04.04-08.06	MTS			
2.8 JTD EGR	2.8	94	04.02-08.06					
				SSR	0986 479 066	280 / 16	BRB	0986 494 049 23921
			Fg.no. 747779→	04.02-08.06	MTS			
			Fg.no. 7477799→	04.02-08.06	MTS			
2.8 TD	2.8	90	10.02-08.06					
				SSR	0986 479 066	280 / 16	BRB	0986 494 049 23921
			Fg.no. 747779→	10.02-08.06	MTS			
			Fg.no. 7477799→	10.02-08.06	MTS			
Ducato 18 [247..]	2.0	71-81	04.02-08.06		0986 479 066	280 / 16	BRB	0986 494 049 23921
2.0 i.e. Bipower CNG 4x4								
2.0 i.e. 4x4	2.0	81	04.02-08.06		0986 479 066	280 / 16	BRB	0986 494 049 23921
2.8 JTD EGR 4x4	2.8	94	04.02-08.06		0986 479 066	280 / 16	BRB	0986 494 049 23921
2.8 JTD 4x4	2.8	94	04.02-08.06		0986 479 066	280 / 16	BRB	0986 494 049 23921
2.8 TD 4x4	2.8	90	10.02-08.06		0986 479 066	280 / 16	BRB	0986 494 049 23921
Ducato 18 [280..]	2.0	63	06.88-06.90					
2.0 Maxi	2.0	63	06.86-06.90					
2.5 D Maxi	2.5	55	01.86-06.90					
2.5 TD Maxi	2.5	68	01.86-06.90					
Ducato 18 [282..]	2.0	63	07.90-02.94					
2.5 D Maxi	2.5	55	07.90-02.94					
2.5 TD Maxi	2.5	70	07.90-02.94					
Fiorino [127..]	1.3	33	04.82-12.87					
1050	1.0	37	01.80-12.81					
			01.82-12.87					
Fiorino [225..]	1.3	55	12.07→					
1.4 i.e.	1.4	55	12.07-08.08					
Fiorino [255..]	1.1	40	01.88-08.93					
1.3	1.3	49	01.88-08.93					
			09.93-12.01					
				ABO				
				ABS				
1.3 D	1.3	33	01.88-08.93					
1.4 i.e.	1.4	49	06.95-12.01					
				ABO				
				ABS				
		52	09.93-06.95					
				ABO				
				ABS				
1.5 i.e.	1.5	55	01.88-08.93					



						S				S		
				0986 477 031 254,5 X 64					1987 475 319			
20,1					LOC	0986 487 701 254 X 57				LOC	0 204 114 646	
												0 986 487 712 0 986 487 712
				0986 477 031 254,5 X 64					1987 475 319			
20,1					LOC	0986 487 701 254 X 57				LOC	0 204 114 646	
												0 986 487 712 0 986 487 712
				0986 477 031 254,5 X 64					1987 475 319			
20,1					LOC	0986 487 701 254 X 57				LOC	0 204 114 646	
												0 986 487 712 0 986 487 712
				0986 477 031 254,5 X 64					1987 475 319			
20,1					LOC	0986 487 701 254 X 57				LOC	0 204 114 646	
												0 986 487 712 0 986 487 712
				0986 477 031 254,5 X 64					1987 475 319			
20,1					LOC	0986 487 701 254 X 57				LOC	0 204 114 646	
												0 986 487 712 0 986 487 712
20,1												
20,1												
20,1												
20,1												
				0986 477 031 254,5 X 64		0986 487 313 254 X 57						
				0986 477 031 254,5 X 64		0986 487 128 254 X 57						
						0986 487 313 254 X 57						
								1987 475 092				
				0986 477 031 254,5 X 64		0986 487 313 254 X 57						
						0986 487 128 254 X 57						
								1987 475 092				
				0986 477 031 254,5 X 64		0986 487 313 254 X 57						
						0986 487 128 254 X 57						
								1987 475 092				
				0986 477 031 254,5 X 64		0986 487 313 254 X 57					0 204 114 530	
				0986 477 031 254,5 X 64		0986 487 313 254 X 57					0 204 114 530	
								1987 475 092				
				0986 477 031 254,5 X 64		0986 487 313 254 X 57					0 204 114 530	
								1987 475 092				
				0986 477 055 185 X 36		0986 487 030 185 X 31			1987 475 167			
				0986 477 055 185 X 36		0986 487 030 185 X 31			1987 475 028			
				0986 477 055 185 X 36		0986 487 030 185 X 31			1987 475 167			
						0986 487 729 228 X 42			1987 475 289			
				0986 477 109 202 X 51,6								
				0986 477 055 185 X 36		0986 487 030 185 X 31			1987 475 167			
				0986 477 055 185 X 36		0986 487 030 185 X 31			1987 475 167			
				0986 477 088 228,5 X 48,5								
								1987 475 266				
						0986 487 255 228,5 X 42						
								1987 475 155				
						0986 487 629 228,5 X 42				LOC	0 204 114 653	
				0986 477 055 185 X 36		0986 487 030 185 X 31			1987 475 167			
				0986 477 088 228,5 X 48,5								
						0986 487 255 228,5 X 42			1987 475 266			
						0986 487 629 228,5 X 42			1987 475 155	LOC	0 204 114 653	
				0986 477 088 228,5 X 48,5								
						0986 487 255 228,5 X 42			1987 475 266			
						0986 487 629 228,5 X 42			1987 475 155	LOC	0 204 114 653	
				0986 477 055 185 X 36		0986 487 030 185 X 31			1987 475 167			





◀ FIAT

Fiorino [255..] 1.6 i.e.	1,6	59	09.93-12.01			
				ABO		
				ABS		
1.7D	1,7	42	01.88-08.93			
		43	01.88-08.93			
			09.93-12.01			
				ABO		
				ABS		
1.7TDS	1,7	46	02.97-12.01			
				ABO		
				ABS		
Fiorino Furgao 1.0	1,0	35	01.94-07.95			
1.0 SPI	1,0	42	08.95-11.95			
1.3 MPI	1,3	49	01.03-09.04			
1.5 MPI	1,5	56	09.97-06.02			
1.7 D	1,7	52	01.04-12.08			
Fiorino Pick-up 1.5 MPI	1,5	56	09.97-06.02			
1.6 MPI	1,6	66	10.95-10.96			
Fiorino Qubo [300..] 1.3 MJTD	1,3	55	09.08→			
Panda Van [241..] 1000 ACT	1,0	33	10.87-05.91			
Scudo [222..] 1.6 i	1,6	58	10.95-05.00			
1.9 D	1,9	51	10.95-05.00			
			06.98-08.01			
			06.04-01.07			
		52	09.01-05.04			
1.9TD	1,9	66	03.97-05.00			
		68	10.95-05.00			
2.0 8V JTD	2,0	70	10.99-05.04			
			06.04-01.07			
		81	10.99-05.04			
			06.04-01.07			
2.0 16V	2,0	100	05.00-05.04			
			06.04-01.07			
2.0 16V JTD	2,0	81	09.00-05.04			
			06.04-01.07			
Scudo [272..] 1.6 D Multijet	1,6	66	01.07→		0986 479 379	290 / 14
2.0 D Multijet	2,0	88	01.07→		0986 479 379	290 / 14
		103	01.07→		0986 479 379	290 / 14
Strada 1.5 MPI 8V	1,5	56	10.98-02.03			
1.6 MPI 16V	1,6	78	02.98-02.03			
Strada [278] 1.2 MPI 8V	1,2	44	03.99-03.03			
		54	05.01-03.03			
			04.03-06.05			
			07.05→			
1.3 JTD	1,3	63	07.05→			
1.7 TDS	1,7	51	03.99-03.03			
1.9 D	1,9	46	11.00-03.03			
			04.03-06.05			
1.9 JTD	1,9	59	04.03-06.05			
Strada Adventure 1.7 TD	1,7	52	10.06-12.08			
Talento 1.9 D	1,9	51	03.88-12.94			
2.0	2,0	55	07.90-12.94			
Uno Van [246..] 0.9	0,9	33	09.89-12.92			
			09.89-03.94			
			04.93-03.94			
1.0	1,0	33	04.92-09.92			
1.0 i.e.	1,0	33	09.89-12.92			
			09.89-03.94			
1.7 D	1,7	42	01.91-03.94			
			01.93-03.94			





FORD

Econovan 2.0D	2,0	41		02.86-10.97			
Falcon Utility [XG] 4.0	4,0	148		03.97→	ZE	0 986 AB6 219	287 / 13
4.0i	4,0	148		03.93-03.96	ZE	0 986 AB6 219	287 / 13
Falcon Utility XR6 [XG] 4.0i	4,0	161		10.93-03.96	ZE	0 986 AB6 219	287 / 13
Falcon Van [XG] 4.0i	4,0	148		03.93-03.96	ZE	0 986 AB6 219	287 / 13
P 100 1.6 L	1,6	54		04.82-09.87			
1.8 L TD	1,8	55		02.89-12.92			
2.0 L	2,0	57		01.88-12.92			
Transit FT 80-190	2,5	50		08.83-02.86			
					A08,SEN, ZWB SEN ZWB		
FT 100/120 2.0	2,0	55-57	Fg.no. Typ 130 Fg.no. Typ 120	01.80-12.85			
FT 100/120/130/160/190	2,4	46		01.83-05.84			
					ZWB		
FT 100-190	2,4	46		01.83-05.84			
					ZWB		
FT 130/160/190 2.0	2,0	55-57	Fg.no. Typ 130 Fg.no. Typ 120	01.80-12.85			
FT 260 2.2 TDCi	2,2	63		04.06→		0 986 479 389	280 / 16
					BSM	0 986 479 401	280 / 16
		81		04.06→		0 986 479 389	280 / 16
					BSM	0 986 479 401	280 / 16
		85		10.08→		0 986 479 389	280 / 16
					BSM	0 986 479 401	280 / 16
		96		04.06→		0 986 479 389	280 / 16
					BSM	0 986 479 401	280 / 16
		103		10.07→		0 986 479 389	280 / 16
					BSM	0 986 479 401	280 / 16
FT 280 2.2 TDCi	2,2	63		04.06→		0 986 479 389	280 / 16
					BSM	0 986 479 401	280 / 16
		81		04.06→		0 986 479 389	280 / 16
					BSM	0 986 479 401	280 / 16
		85		10.08→		0 986 479 389	280 / 16
					BSM	0 986 479 401	280 / 16
		96		04.06→		0 986 479 389	280 / 16
					BSM	0 986 479 401	280 / 16
		103		10.07→		0 986 479 389	280 / 16
					BSM	0 986 479 401	280 / 16
FT 280 S 2.4 TDI	2,4	66		01.01-05.06			
					OZB ZWB		
FT 300 2.2 TDCi	2,2	63		04.06→		0 986 479 389	280 / 16
					BSM	0 986 479 401	280 / 16
		81		04.06→		0 986 479 389	280 / 16
					BSM	0 986 479 401	280 / 16
		85		10.08→		0 986 479 389	280 / 16
					BSM	0 986 479 401	280 / 16
		96		04.06→		0 986 479 389	280 / 16
					BSM	0 986 479 401	280 / 16
		103		10.07→		0 986 479 389	280 / 16
					BSM	0 986 479 401	280 / 16
FT 300 2.4 TDCi	2,4	74		07.06→		0 986 479 390	280 / 16
FT 300 S 2.0 TDCi	2,0	92		05.02-05.06			
					OZB ZWB		





◀ FORD

Transit	2,4	66	01.01-05.06			
FT 300 S 2.4 TDI				OZB		
				ZWB		
		74	01.01-05.06			
				OZB		
				ZWB		
FT 310 S 2.4 TDI	2,4	88	01.01-05.06			
				OZB		
				ZWB		
FT 330 2.2 TDCi	2,2	81	04.06→		0 986 479 389	280 / 16
				BSM	0 986 479 401	280 / 16
		85	10.08→		0 986 479 389	280 / 16
				BSM	0 986 479 401	280 / 16
		96	04.06→		0 986 479 389	280 / 16
				BSM	0 986 479 401	280 / 16
		103	10.07→		0 986 479 389	280 / 16
				BSM	0 986 479 401	280 / 16
FT 330 2.3i	2,3	107	04.06→		0 986 479 390	280 / 16
FT 330 2.3i CNG	2,3	100-107	04.06→		0 986 479 390	280 / 16
FT 330 2.3i LPG	2,3	107	04.06→		0 986 479 390	280 / 16
FT 330 2.4 TDCi	2,4	74	07.06→		0 986 479 390	280 / 16
		85	07.06→		0 986 479 390	280 / 16
		103	07.06→		0 986 479 390	280 / 16
FT 330 2.4 TDCi 4x4	2,4	103	09.07→		0 986 479 390	280 / 16
FT 330 L 2.4 TDI	2,4	66	01.01-05.06			
				OZB		
				ZWB		
		88	01.01-05.06			
				OZB		
				ZWB		
FT 330 M 2.4 TDI	2,4	66	01.01-05.06			
				OZB		
				ZWB		
		88	01.01-05.06			
				OZB		
				ZWB		
FT 330 S 2.4 TDI	2,4	66	01.01-05.06			
				OZB		
				ZWB		
		74	01.01-05.06			
				OZB		
				ZWB		
		88	01.01-05.06			
				OZB		
				ZWB		
FT 350 2.2 TDCi	2,2	81	04.06→		0 986 479 389	280 / 16
				BSM	0 986 479 401	280 / 16
		85	10.08→		0 986 479 389	280 / 16
				BSM	0 986 479 401	280 / 16
		96	04.06→		0 986 479 389	280 / 16
				BSM	0 986 479 401	280 / 16
		103	10.07→		0 986 479 389	280 / 16
				BSM	0 986 479 401	280 / 16
FT 350 2.3i	2,3	107	04.06→		0 986 479 390	280 / 16
FT 350 2.3i CNG	2,3	100-107	04.06→		0 986 479 390	280 / 16
FT 350 2.3i LPG	2,3	107	04.06→		0 986 479 390	280 / 16
FT 350 2.4 TDCi	2,4	74	07.06→		0 986 479 390	280 / 16
		85	07.06→		0 986 479 390	280 / 16
		103	07.06→		0 986 479 390	280 / 16
FT 350 2.4 TDCi 4x4	2,4	103	09.07→		0 986 479 390	280 / 16
FT 350 3.2 TDCi	3,2	147	08.07→		0 986 479 390	280 / 16





◀ FORD

Transit	2,4	66		01.01-05.06			
FT 350 E 2.4 TDI					OZB		
					ZWB		
		88		01.01-05.06			
					OZB		
					ZWB		
		96		06.04-05.06			
					OZB		
					ZWB		
FT 350 L 2.4 TDI	2,4	66		01.01-05.06			
					OZB		
					ZWB		
		88		01.01-05.06			
					OZB		
					ZWB		
		96		06.04-05.06			
					OZB		
					ZWB		
FT 350 M 2.4 TDI	2,4	66		01.01-05.06			
					OZB		
					ZWB		
		88		01.01-05.06			
					OZB		
					ZWB		
		96		06.04-05.06			
					OZB		
					ZWB		
FT 430 2.4 TDCi	2,4	74		07.06→		0 986 479 390	280 / 16
		85		07.06→		0 986 479 390	280 / 16
		103		07.06→		0 986 479 390	280 / 16
FT 430 2.4 TDCi 4x4	2,4	103		09.07→		0 986 479 390	280 / 16
FT 430 E 2.4 TDI	2,4	96		06.04-05.06			
					OZB		
					ZWB		
	2,8	68		12.97→			
Transit [E_] FT 080 2.0i	2,0	84	Rear axle Typ 34	08.94-07.00			
					5LO		
			Rear axle Typ 51; 53	08.94-07.00	6LO		
FT 080 2.5 D	2,5	51	Rear axle Typ 34	08.94-08.00			
					5LO		
			Rear axle Typ 51; 53	08.94-08.00	6LO		
FT 080 2.5 DI	2,5	56	Rear axle Typ 34	08.94-08.00			
					5LO		
			Rear axle Typ 51; 53	08.94-08.00	6LO		
FT 080 2.5 TD	2,5	55	Rear axle Typ 34	08.94-08.00			
		63	Rear axle Typ 34	08.94-08.00			
					5LO		
			Rear axle Typ 51; 53	08.94-08.00	6LO		
		74	Rear axle Typ 34	08.94-08.00			
					5LO		
			Rear axle Typ 51; 53	08.94-08.00	6LO		
FT 080 2.5 TDI	2,5	63	Rear axle Typ 34	08.94-08.00			
					5LO		
			Rear axle Typ 51; 53	08.94-08.00	6LO		
		85	Rear axle Typ 34	03.99-08.00			
					5LO		
			Rear axle Typ 51; 53	03.99-08.00	6LO		
FT 100 2.0i	2,0	84	Rear axle Typ 34	08.94-07.00			
					5LO		
			Rear axle Typ 51; 53	08.94-07.00	6LO		
FT 100 2.5 D	2,5	51	Rear axle Typ 34	08.94-08.00			
					5LO		
			Rear axle Typ 51; 53	08.94-08.00	6LO		





◀ FORD

Transit [E_]	2,5	56	Rear axle Typ 34	08.94-08.00	5LO
FT 100 2.5 DI			Rear axle Typ 51; 53	08.94-08.00	6LO
FT 100 2.5 TD	2,5	63	Rear axle Typ 34	08.94-08.00	5LO
			Rear axle Typ 51; 53	08.94-08.00	6LO
		74	Rear axle Typ 34	08.94-08.00	5LO
			Rear axle Typ 51; 53	08.94-08.00	6LO
FT 100 2.5 TDI	2,5	63	Rear axle Typ 34	08.94-08.00	5LO
			Rear axle Typ 51; 53	08.94-08.00	6LO
		85	Rear axle Typ 34	03.99-08.00	5LO
			Rear axle Typ 51; 53	03.99-08.00	6LO
FT 120 2.0i	2,0	84	Rear axle Typ 34	08.94-07.00	5LO
			Rear axle Typ 51; 53	08.94-07.00	6LO
FT 120 2.5 D	2,5	51	Rear axle Typ 34	08.94-08.00	5LO
			Rear axle Typ 51; 53	08.94-08.00	6LO
FT 120 2.5 DI	2,5	56	Rear axle Typ 34	08.94-08.00	5LO
			Rear axle Typ 51; 53	08.94-08.00	6LO
FT 120 2.5 TD	2,5	63	Rear axle Typ 34	08.94-08.00	5LO
			Rear axle Typ 51; 53	08.94-08.00	6LO
		74	Rear axle Typ 34	08.94-08.00	5LO
			Rear axle Typ 51; 53	08.94-08.00	6LO
FT 120 2.5 TDI	2,5	85	Rear axle Typ 34	03.99-08.00	5LO
			Rear axle Typ 51	03.99-08.00	6LO
			Rear axle Typ 53		
FT 150 2.0i	2,0	84	Rear axle Typ 34	08.94-07.00	5LO
			Rear axle Typ 51; 53	08.94-07.00	6LO
FT 150 2.5 DI	2,5	56	Rear axle Typ 34	08.94-08.00	5LO
			Rear axle Typ 51; 53	08.94-08.00	6LO
FT 150 2.5 TD	2,5	63	Rear axle Typ 34	08.94-08.00	5LO
			Rear axle Typ 51; 53	08.94-08.00	6LO
		74	Rear axle Typ 34	08.94-08.00	5LO
			Rear axle Typ 51; 53	08.94-08.00	6LO
FT 150 2.5 TDI	2,5	63	Rear axle Typ 34	08.94-08.00	5LO
			Rear axle Typ 51; 53	08.94-08.00	6LO
		85	Rear axle Typ 34	03.99-08.00	5LO
			Rear axle Typ 51; 53	03.99-08.00	6LO
FT 190 2.0i	2,0	84	Rear axle Typ 34	08.94-07.00	5LO
			Rear axle Typ 51; 53	08.94-07.00	6LO
FT 190 2.5 DI	2,5	56		08.94-08.00	T07
			Rear axle Typ 34	08.94-08.00	5LO
			Rear axle Typ 51; 53	08.94-08.00	6LO
FT 190 2.5 TD	2,5	63		08.94-08.00	T07
			Rear axle Typ 34	08.94-08.00	5LO
			Rear axle Typ 51; 53	08.94-08.00	6LO





◀ FORD

Transit [E_]	2,5	74		08.94-08.00	T07
FT 190 2.5 TD			Rear axle Typ 34	08.94-08.00	5LO
			Rear axle Typ 51; 53	08.94-08.00	6LO
FT 190 2.5 TDI	2,5	63		08.94-08.00	T07
			Rear axle Typ 34	08.94-08.00	5LO
			Rear axle Typ 51; 53	08.94-08.00	6LO
		85		03.99-08.00	T07
			Rear axle Typ 34	03.99-08.00	5LO
			Rear axle Typ 51; 53	03.99-08.00	6LO
2.0 i LWB 100-190	2,0	72		08.91-07.94	D22
					D25
					T07
					T08
					5LO
					6LO
			Rear axle T34	08.91-07.94	5LO
			Rear axle T51/T53	08.91-07.94	6LO
2.0 i SWB 80-150	2,0	72		08.91-07.94	D22
					D25
					T07
					T08
					5LO
					6LO
			Rear axle T34	08.91-07.94	5LO
			Rear axle T51/T53	08.91-07.94	6LO
2.0 LWB 100-190	2,0	66		08.91-07.94	D22
					D25
					T07
					T08
					5LO
					6LO
			Rear axle T34	08.91-07.94	5LO
			Rear axle T51/T53	08.91-07.94	6LO
2.0 SWB 80-150	2,0	66		08.91-07.94	D22
					D25
					T07
					T08
					5LO
					6LO
			Rear axle T34	08.91-07.94	5LO
			Rear axle T51/T53	08.91-07.94	6LO
2.5 Di LWB 100 L	2,5	52		08.91-07.94	D22
					D25
					T07
					T08
					5LO
					6LO
			Rear axle T34	08.91-07.94	5LO
			Rear axle T51/T53	08.91-07.94	6LO
2.5 Di LWB 100-190	2,5	59		08.91-07.94	D22
					D25
					T07
					T08
					5LO
					6LO
			Rear axle T34	08.91-07.94	5LO
			Rear axle T51/T53	08.91-07.94	6LO



											0 204 114 044
			0 986 477 048	254X61							
						0 986 487 525	280X64				
			0 986 477 047	280X111							0 204 114 044
			0 986 477 048	254X61							
						0 986 487 525	280X64				
			0 986 477 047	280X111							0 204 114 044
			0 986 477 048	254X61							
						0 986 487 525	280X64				
			0 986 477 047	280X111							0 204 114 044
											0 204 114 043
											0 204 114 042
											0 204 114 044
											0 204 114 045
						0 986 487 524	254X50	1 987 475 139			
						0 986 487 401	280X64	1 987 475 138			
			0 986 477 048	254X61							
			0 986 477 047	280X111							
											0 204 114 043
											0 204 114 042
											0 204 114 044
											0 204 114 045
						0 986 487 524	254X50	1 987 475 139			
						0 986 487 401	280X64	1 987 475 138			
			0 986 477 048	254X61							
			0 986 477 047	280X111							
											0 204 114 043
											0 204 114 042
											0 204 114 044
											0 204 114 045
						0 986 487 524	254X50	1 987 475 139			
						0 986 487 401	280X64	1 987 475 138			
			0 986 477 048	254X61							
			0 986 477 047	280X111							
											0 204 114 043
											0 204 114 042
											0 204 114 044
											0 204 114 045
						0 986 487 524	254X50	1 987 475 139			
						0 986 487 401	280X64	1 987 475 138			
			0 986 477 048	254X61							
			0 986 477 047	280X111							
											0 204 114 043
											0 204 114 042
											0 204 114 044
											0 204 114 045
						0 986 487 524	254X50	1 987 475 139			
						0 986 487 401	280X64	1 987 475 138			
			0 986 477 048	254X61							
			0 986 477 047	280X111							





◀ FORD

Transit [E_] 2.5 DI SWB 80-120	2,5	51-52	08.91-07.94	D22					
				D25					
				T07					
				T08					
				5LO					
				6LO					
				Rear axle T34	08.91-07.94	5LO			
				Rear axle T51/T53	08.91-07.94	6LO			
				52			08.91-07.94	D22	
								D25	
T07									
T08									
5LO									
6LO									
Rear axle T34	08.91-07.94	5LO							
Rear axle T51/T53	08.91-07.94	6LO							
2.5 DI SWB 80-150	2,5	59	08.91-07.94					D22	
								D25	
				T07					
				T08					
				5LO					
				6LO					
				Rear axle T34	08.91-07.94	5LO			
				Rear axle T51/T53	08.91-07.94	6LO			
				2.5 DI Turbo LWB 100-190	2,5	63	10.92-07.94	D22	
								D25	
T07									
T08									
5LO									
6LO									
Rear axle T34	10.92-07.94	5LO							
Rear axle T51/T53	10.92-07.94	6LO							
2.5 DI Turbo LWB 150+190 L	2,5	74	08.91-07.94					D22	
								D25	
				T07					
				T08					
				5LO					
				6LO					
				Rear axle T34	08.91-07.94	5LO			
				Rear axle T51/T53	08.91-07.94	6LO			
				2.5 DI Turbo SWB 80-150	2,5	63	10.92-07.94	D22	
								D25	
T07									
T08									
5LO									
6LO									
Rear axle T34	10.92-07.94	5LO							
Rear axle T51/T53	10.92-07.94	6LO							
2.5 DI Turbo SWB 150 S	2,5	74	08.91-07.94					D22	
								D25	
				T07					
				T08					
				5LO					
				6LO					
				Rear axle T34	08.91-07.94	5LO			
				Rear axle T51/T53	08.91-07.94	6LO			





◀ FORD

Transit [E_]	2,9	104	08.91-07.94	D22	
2.9 V6 LWB 100L-190				D25	
				T07	
				T08	
				5LO	
				6LO	
		Rear axle T34	08.91-07.94	5LO	
		Rear axle T51/T53	08.91-07.94	6LO	
Transit [F_]	2,0	55	08.00-07.06		
FT 240 K/S 2.0 TD					
FT 240 K/S 2.0 TDE	2,0	63	08.00-07.06		
FT 260 K/S 2.0 TD	2,0	55	08.00-07.06		
FT 260 K/S 2.0 TDCi	2,0	92	05.02-07.06		
FT 260 K/S 2.0 TDE	2,0	63	08.00-07.06		
		74	08.00-07.06		
FT 260 K/S 2.3i	2,3	103-107	08.01-07.06		
				OZB	
				ZWB	
FT 260 K/S 2.4 TDE	2,4	66	04.01-07.06		
				OZB	
				ZWB	
FT 280 K/S 2.0 TD	2,0	55	08.00-07.06		
FT 280 K/S 2.0 TDCi	2,0	92	05.02-07.06		
FT 280 K/S 2.0 TDE	2,0	63	08.00-07.06		
		74	08.00-07.06		
FT 280 K/S 2.3i	2,3	103-107	08.01-07.06		
				OZB	
				ZWB	
FT 280 K/S 2.4 TDE	2,4	66	04.01-07.06		
				OZB	
				ZWB	
FT 280 L 2.3i	2,3	103-107	08.01-07.06		
				OZB	
				ZWB	
FT 280 L 2.4 TDE	2,4	55	01.00-09.03		
				OZB	
				ZWB	
		66	01.00-07.06		
				OZB	
				ZWB	
		85	03.04-07.06		
				OZB	
				ZWB	
		92	01.00-07.06		
				OZB	
				ZWB	
FT 280 M 2.0 TD	2,0	55	08.00-07.06		
FT 280 M 2.0 TDCi	2,0	92	05.02-07.06		
	2,0	63	08.00-07.06		
FT 280 M 2.0 TDE		74	08.00-07.06		
FT 280 M 2.3i	2,3	103-107	08.01-07.06		
				OZB	
				ZWB	
FT 280 M 2.4 TDE	2,4	66	04.01-07.06		
				OZB	
				ZWB	
FT 300 K/S 2.0 TD	2,0	55	08.00-07.06		
FT 300 K/S 2.0 TDCi	2,0	92	05.02-07.06		
FT 300 K/S 2.0 TDE	2,0	63	08.00-07.06		
		74	08.00-07.06		
FT 300 K/S 2.3i	2,3	107	08.00-07.06		
				OZB	
				ZWB	



											0 204 114 043
											0 204 114 042
											0 204 114 044
											0 204 114 045
						0 986 487 524	254 X 50		1 987 475 139		
						0 986 487 401	280 X 64		1 987 475 138		
			0 986 477 048	254 X 61							
			0 986 477 047	280 X 111							
						0 986 487 660	254 X 52		1 987 475 284		
						0 986 487 660	254 X 52		1 987 475 284		
						0 986 487 660	254 X 52		1 987 475 284		
						0 986 487 660	254 X 52		1 987 475 284		
						0 986 487 660	254 X 52		1 987 475 284		
						0 986 487 612	280 X 65				0 204 114 194
											0 204 114 195
						0 986 487 612	280 X 65				0 204 114 194
											0 204 114 195
						0 986 487 660	254 X 52		1 987 475 284		
						0 986 487 660	254 X 52		1 987 475 284		
						0 986 487 660	254 X 52		1 987 475 284		
						0 986 487 660	254 X 52		1 987 475 284		
						0 986 487 612	280 X 65				0 204 114 194
											0 204 114 195
						0 986 487 612	280 X 65				0 204 114 194
											0 204 114 195
						0 986 487 612	280 X 65				0 204 114 194
											0 204 114 195
						0 986 487 612	280 X 65				0 204 114 194
											0 204 114 195
						0 986 487 612	280 X 65				0 204 114 194
											0 204 114 195
						0 986 487 660	254 X 52		1 987 475 284		
						0 986 487 660	254 X 52		1 987 475 284		
						0 986 487 660	254 X 52		1 987 475 284		
						0 986 487 660	254 X 52		1 987 475 284		
						0 986 487 612	280 X 65				0 204 114 194
											0 204 114 195
						0 986 487 612	280 X 65				0 204 114 194
											0 204 114 195
						0 986 487 660	254 X 52		1 987 475 284		
						0 986 487 660	254 X 52		1 987 475 284		
						0 986 487 660	254 X 52		1 987 475 284		
						0 986 487 660	254 X 52		1 987 475 284		
						0 986 487 612	280 X 65				0 204 114 194
											0 204 114 195
						0 986 487 612	280 X 65				0 204 114 194
											0 204 114 195
						0 986 487 660	254 X 52		1 987 475 284		
						0 986 487 660	254 X 52		1 987 475 284		
						0 986 487 660	254 X 52		1 987 475 284		
						0 986 487 660	254 X 52		1 987 475 284		
						0 986 487 612	280 X 65				0 204 114 194
											0 204 114 195





◀ FORD

Transit [F...]	FT 300 L 2.0 TD	2,0	55	08.00-07.06	
	FT 300 L 2.0 TDCi	2,0	92	05.02-07.06	
	FT 300 L 2.0 TDE	2,0	63	08.00-07.06	
			74	08.00-07.06	
	FT 300 L 2.3i	2,3	107	08.00-07.06	
					OZB
					ZWB
	FT 300 M 2.0 TD	2,0	55	08.00-07.06	
	FT 300 M 2.0 TDCi	2,0	92	05.02-07.06	
	FT 300 M 2.0 TDE	2,0	63	08.00-07.06	
			74	08.00-07.06	
	FT 300 M 2.3i	2,3	107	08.00-07.06	
					OZB
					ZWB
	FT 330 K/S 2.0 TDCi	2,0	92	05.02-07.06	
	FT 330 K/S 2.0 TDE	2,0	74	08.03-07.06	
	FT 330 K/S 2.3i	2,3	103-107	08.01-07.06	
					OZB
					ZWB
			107	12.00-07.06	
					OZB
					ZWB
	FT 330 K/S 2.4 TD	2,4	55	01.00-09.03	
					OZB
					ZWB
	FT 330 K/S 2.4 TDCi	2,4	101	03.04-07.06	
					OZB
					ZWB
	FT 330 K/S 2.4 TDE	2,4	66	01.00-07.06	
					OZB
					ZWB
			85	03.04-07.06	
					OZB
					ZWB
			88	01.00-07.06	
					OZB
					ZWB
			92	01.00-07.06	
					OZB
					ZWB
	FT 330 L 2.0 TDCi	2,0	92	05.02-07.06	
	FT 330 L 2.0 TDE	2,0	74	08.03-07.06	
	FT 330 L 2.3i	2,3	103-107	08.01-07.06	
					OZB
					ZWB
			107	12.00-07.06	
					OZB
					ZWB
	FT 330 L 2.4 TD	2,4	55	01.00-09.03	
					OZB
					ZWB
	FT 330 L 2.4 TDCi	2,4	101	03.04-07.06	
					OZB
					ZWB
	FT 330 L 2.4 TDE	2,4	66	01.00-07.06	
					OZB
					ZWB





◀ FORD

Transit [F...]	2,4	85	03.04-07.06	OZB
FT 330 L2.4 TDE				ZWB
	88		01.00-07.06	OZB
				ZWB
	92		01.00-07.06	OZB
				ZWB
FT 330 M 2.0 TDCi	2,0	92	05.02-07.06	
FT 330 M 2.0 TDE	2,0	74	08.03-07.06	
FT 330 M 2.3i	2,3	103-107	08.01-07.06	OZB
				ZWB
	107		12.00-07.06	OZB
				ZWB
FT 330 M 2.4 TD	2,4	55	01.00-09.03	OZB
				ZWB
FT 330 M 2.4 TDCi	2,4	101	03.04-07.06	OZB
				ZWB
FT 330 M 2.4 TDE	2,4	66	01.00-07.06	OZB
				ZWB
	85		03.04-07.06	OZB
				ZWB
	88		01.00-07.06	OZB
				ZWB
	92		01.00-07.06	OZB
				ZWB
FT 350 EL 2.0 TDCi	2,0	92	05.02-07.06	
FT 350 EL 2.0 TDE	2,0	74	08.03-07.06	
FT 350 EL 2.3i	2,3	103-107	08.01-07.06	OZB
				ZWB
	107		12.00-07.06	OZB
				ZWB
FT 350 EL 2.4 TD	2,4	55	01.00-09.03	OZB
				ZWB
FT 350 EL 2.4 TDCi	2,4	101	03.04-07.06	OZB
				ZWB
FT 350 EL 2.4 TDE	2,4	66	01.00-07.06	OZB
				ZWB
	85		03.04-07.06	OZB
				ZWB
	92		01.00-07.06	OZB
				ZWB



					S				S		
						0986 487 612	280 X 65				0 204 114 194
											0 204 114 195
						0986 487 612	280 X 65				0 204 114 194
											0 204 114 195
						0986 487 612	280 X 65				0 204 114 194
											0 204 114 195
								1 987 475 284			
						0986 487 612	280 X 65				0 204 114 194
						0986 487 612	280 X 65				0 204 114 194
								1 987 475 284			
						0986 487 612	280 X 65				0 204 114 194
											0 204 114 195
						0986 487 612	280 X 65				0 204 114 194
											0 204 114 195
						0986 487 612	280 X 65				0 204 114 194
											0 204 114 195
						0986 487 612	280 X 65				0 204 114 194
											0 204 114 195
						0986 487 612	280 X 65				0 204 114 194
											0 204 114 195
						0986 487 612	280 X 65				0 204 114 194
											0 204 114 195
						0986 487 612	280 X 65				0 204 114 194
											0 204 114 195
						0986 487 612	280 X 65				0 204 114 194
											0 204 114 195
						0986 487 612	280 X 65				0 204 114 194
											0 204 114 195
						0986 487 612	280 X 65				0 204 114 194
											0 204 114 195
						0986 487 612	280 X 65				0 204 114 194
											0 204 114 195
						0986 487 612	280 X 65				0 204 114 194
											0 204 114 195
						0986 487 612	280 X 65				0 204 114 194
											0 204 114 195
						0986 487 612	280 X 65				0 204 114 194
											0 204 114 195
						0986 487 612	280 X 65				0 204 114 194
											0 204 114 195
						0986 487 612	280 X 65				0 204 114 194
											0 204 114 195
						0986 487 612	280 X 65				0 204 114 194
											0 204 114 195
						0986 487 612	280 X 65				0 204 114 194
											0 204 114 195
						0986 487 612	280 X 65				0 204 114 194
											0 204 114 195
						0986 487 612	280 X 65				0 204 114 194
											0 204 114 195
						0986 487 612	280 X 65				0 204 114 194
											0 204 114 195





◀ FORD

Transit [F...]	2,0	92	05.02-07.06	
FT 350 L 2.0 TDCi				
FT 350 L 2.0 TDE	2,0	74	08.03-07.06	
FT 350 L 2.3i	2,3	103-107	08.01-07.06	OZB ZWB
		107	12.00-07.06	OZB ZWB
FT 350 L 2.4 TD	2,4	55	01.00-09.03	OZB ZWB
FT 350 L 2.4 TDCi	2,4	101	03.04-07.06	OZB ZWB
FT 350 L 2.4 TDE	2,4	66	01.00-07.06	OZB ZWB
		85	03.04-07.06	OZB ZWB
		88	01.00-07.06	OZB ZWB
		92	01.00-07.06	OZB ZWB
FT 350 M 2.0 TDCi	2,0	92	05.02-07.06	
	2,0	74	08.03-07.06	
FT 350 M 2.0 TDE				
FT 350 M 2.3i	2,3	103-107	08.01-07.06	OZB ZWB
		107	12.00-07.06	OZB ZWB
FT 350 M 2.4 TD	2,4	55	01.00-09.03	OZB ZWB
FT 350 M 2.4 TDCi	2,4	101	03.04-07.06	OZB ZWB
FT 350 M 2.4 TDE	2,4	66	01.00-07.06	OZB ZWB
		85	03.04-07.06	OZB ZWB
		88	01.00-07.06	OZB ZWB
		92	01.00-07.06	OZB ZWB
FT 430 EL 2.4 TD	2,4	55	08.02-09.03	OZB ZWB
FT 430 EL 2.4 TDCi	2,4	101	03.04-07.06	OZB ZWB





◀ FORD

Transit Connect [02]		1,8	55		08.06-03.09				
1.8 TDCi					08.06→	0986 479 070	278 / 11		
					04.08→	RAB		ATE	0986 494 032 23482
			66		05.02-03.09				
					05.02→	0986 479 070	278 / 11		
					04.08→	RAB		ATE	0986 494 032 23482
			81		08.06-03.09				
					08.06→	0986 479 070	278 / 11		
					04.08→	RAB		ATE	0986 494 032 23482
1.8 TDDi		1,8	55		05.02-03.09				
					05.02→	0986 479 070	278 / 11		
					04.08→	RAB		ATE	0986 494 032 23482
Transit Euroline 2.2 TDCi		2,2	81		04.06→	0986 479 389	280 / 16		
						BSM	0986 479 401	280 / 16	
			85		10.08→	0986 479 389	280 / 16		
						BSM	0986 479 401	280 / 16	
			96		04.06→	0986 479 389	280 / 16		
						BSM	0986 479 401	280 / 16	
			103		10.07→	0986 479 389	280 / 16		
						BSM	0986 479 401	280 / 16	
Transit Euroline [E_] 2.0 i		2,0	84	Rear axle Typ 34	08.94-07.00				
						5LO			
				Rear axle Typ 51	08.94-07.00				
				Rear axle Typ 53		6LO			
2.5 D		2,5	51	Rear axle Typ 34	08.94-08.00				
						5LO			
				Rear axle Typ 51	08.94-08.00				
				Rear axle Typ 53		6LO			
2.5 DI		2,5	56	Rear axle Typ 34	08.94-08.00				
						5LO			
				Rear axle Typ 51	08.94-08.00				
				Rear axle Typ 53		6LO			
2.5 TD		2,5	63	Rear axle Typ 34	08.94-08.00				
						5LO			
				Rear axle Typ 51	08.94-08.00				
				Rear axle Typ 53		6LO			
2.5 TDI		2,5	85	Rear axle Typ 34	03.99-08.00				
						5LO			
				Rear axle Typ 51	03.99-08.00				
				Rear axle Typ 53		6LO			
Transit Euroline [F_...]		2,0	92		05.02-07.06				
2.0 TDCi									
2.0 TDE		2,0	74		08.00-07.06				
Transit Nugget 2.2 TDCi		2,2	81		04.06→	0986 479 389	280 / 16		
						BSM	0986 479 401	280 / 16	
			85		10.08→	0986 479 389	280 / 16		
						BSM	0986 479 401	280 / 16	
			96		04.06→	0986 479 389	280 / 16		
						BSM	0986 479 401	280 / 16	
			103		10.07→	0986 479 389	280 / 16		
						BSM	0986 479 401	280 / 16	





◀ FORD

Transit Nugget [E_] 2.0 i	2,0	84	Rear axle Typ 34	08.94-07.00				
					5LO			
			Rear axle Typ 51	08.94-07.00				
			Rear axle Typ 53		6LO			
2.5 D	2,5	51	Rear axle Typ 34	08.94-08.00				
					5LO			
			Rear axle Typ 51	08.94-08.00				
			Rear axle Typ 53		6LO			
2.5 DI	2,5	56	Rear axle Typ 34	08.94-08.00				
					5LO			
			Rear axle Typ 51	08.94-08.00				
			Rear axle Typ 53		6LO			
2.5 TD	2,5	63	Rear axle Typ 34	08.94-08.00				
					5LO			
			Rear axle Typ 51	08.94-08.00				
			Rear axle Typ 53		6LO			
2.5 TDI	2,5	85	Rear axle Typ 34	03.99-08.00				
					5LO			
			Rear axle Typ 51	03.99-08.00				
			Rear axle Typ 53		6LO			
Transit Nugget [F_] 2.0 TDCi	2,0	92		05.02-07.06				
2.0 TDE	2,0	74		08.00-07.06				
Transit Tourneo 2.2 TDCi	2,2	81		04.06→		0 986 479 389	280 / 16	
					BSM	0 986 479 401	280 / 16	
		85		10.08→		0 986 479 389	280 / 16	
					BSM	0 986 479 401	280 / 16	
		96		04.06→		0 986 479 389	280 / 16	
					BSM	0 986 479 401	280 / 16	
		103		10.07→		0 986 479 389	280 / 16	
					BSM	0 986 479 401	280 / 16	
Transit Tourneo [E_] 2.0 i	2,0	84	Rear axle Typ 34	08.94-07.00				
					5LO			
			Rear axle Typ 51	08.94-07.00				
			Rear axle Typ 53		6LO			
2.5 D	2,5	51	Rear axle Typ 34	08.94-08.00				
					5LO			
			Rear axle Typ 51	08.94-08.00				
			Rear axle Typ 53		6LO			
2.5 DI	2,5	56	Rear axle Typ 34	08.94-08.00				
					5LO			
			Rear axle Typ 51	08.94-08.00				
			Rear axle Typ 53		6LO			
2.5 TD	2,5	63	Rear axle Typ 34	08.94-08.00				
					5LO			
			Rear axle Typ 51	08.94-08.00				
			Rear axle Typ 53		6LO			
2.5 TDI	2,5	63	Rear axle Typ 34	08.94-08.00				
					5LO			
			Rear axle Typ 51	08.94-08.00				
			Rear axle Typ 53		6LO			
		85	Rear axle Typ 34	03.99-08.00				
					5LO			
			Rear axle Typ 51	03.99-08.00				
			Rear axle Typ 53		6LO			
Transit Tourneo [F_] 2.0 TDCi	2,0	92		05.02-07.06				
2.0 TDE	2,0	74		08.00-07.06				





HYUNDAI

Grace 2.4 i Super	2,4	90	10.95→
2.5 D	2,5	59	10.95→
2.5 Intercooler	2,5	63	10.95→
H 100 2.4 i	2,4	90	07.93-03.00
2.5 D	2,5	55	02.93-12.94
		57	07.94-03.00
		59	07.93-03.00
2.5 Intercooler	2,5	57	07.94-03.00
2.5 TCI	2,5	63	09.96-09.04
		70	10.04→

INNOCENTI (NUOVA INNOCENTI)

Elba 1.7 D	1,7	42	09.92-12.96
-------------------	-----	----	-------------

ISUZU

Campo 2.2 Sports-Cab	2,2	66	01.89-12.90
Pick-Up [KB] 2.0 D	2,0	34	01.83-12.88

IVECO

Daily L 29 L 10	2,3	70	09.02-03.06	ABO	0986 479 161	276 / 16		
				ABS	0986 479 163	276 / 16		
							BRB 0986 424 750 29 123	
L 29 L 12	2,3	85	09.02-03.06	ABO	0986 479 161	276 / 16		
				ABS	0986 479 163	276 / 16		
							BRB 0986 424 750 29 123	
Daily Chassi 35 .13	2,8	92	10.05-07.07		0986 478 886	289 / 22	BRB 0986 424 833 29 121	
					0986 478 886	289 / 22	BRB 0986 424 833 29 121	
					0986 478 886	289 / 22	BRB 0986 424 833 29 121	
Daily Furgao 38 .13	2,8	92	10.05-07.07		0986 478 886	289 / 22	BRB 0986 424 833 29 121	
					0986 478 886	289 / 22	BRB 0986 424 833 29 121	
					0986 478 886	289 / 22	BRB 0986 424 833 29 121	
Daily, Grinta	2,5	62	02.85-06.89		0986 478 886	289 / 22		
				Bo-Frost 35-10 Turbo				
				Duty 35-8	2,5	55	07.89-06.90	OVA
				4SB	0986 478 886	289 / 22		
New Daily A45-10 Turbo	2,5	76	07.89-04.96	OVA				
New Daily 35-8	2,5	55	02.91-04.96	4SB	0986 478 886	289 / 22		
		60	05.96-03.98					
				4SB	0986 478 886	289 / 22		
	2,8	62	04.98-05.99	4SB	0986 478 886	289 / 22		
New Daily 35-10 Turbo	2,5	66,1-68,9	07.91-04.96					
New Daily 35-10 Turbo I.D.	2,5	80	07.92-04.97					
New Daily 40-8	2,5	55	07.89-04.96					
Restyling 35-8	2,4	53	01.82-12.83					
			01.87-06.89	OVA				
Restyling 40-8	2,4	53	01.83-06.89					
			01.87-06.89	OVA				
Restyling 45-10 Turbo	2,4	67	02.85-06.89	OVA				
Restyling 49-10 Turbo	2,4	67	02.85-06.89	OVA				
Turbo Daily A40-10 Turbo	2,8	76	05.96-05.99	4SB	0986 478 886	289 / 22		
Turbo Daily A40-12 Turbo	2,8	90	05.96-05.99	4SB	0986 478 886	289 / 22		
Turbo Daily A45-10 Turbo	2,8	76	05.96-05.99	4SB	0986 478 886	289 / 22		
Turbo Daily A45-12 Turbo	2,8	90	05.96-05.99	4SB	0986 478 886	289 / 22		
Turbo Daily A49-10 Turbo	2,8	76	05.96-05.99	4SB	0986 478 886	289 / 22		





◀ IVECO

Daily, Grinta	2,8	76	05.96-05.99	ABO			
Turbo Daily 30-10 Turbo							
Turbo Daily 35-10 Turbo	2,5	80	07.92-04.97			BRB	0 986 424 833 29 121
				4SB	0 986 478 886	289 / 22	
				14Z			
	2,8	76	05.96-05.99			BRB	0 986 424 833 29 121
				4SB	0 986 478 886	289 / 22	
				14Z			
Turbo Daily 35-12 Turbo	2,5	85	10.90-04.96	ABO			
				ABS			
	2,8	90	05.96-05.99	4SB	0 986 478 886	289 / 22	
				14Z			
Turbo Daily 40-10 Turbo 4x4	2,8	76	05.96-05.99	4SB	0 986 478 886	289 / 22	
Turbo Daily 49-10 Turbo	2,8	76	05.96-05.99	4SB	0 986 478 886	289 / 22	
Turbo Daily 49-12 Turbo	2,8	90	05.96-05.99	4SB	0 986 478 886	289 / 22	
35-11	2,8	78	01.99-07.99		0 986 478 886	289 / 22	
49-11	2,8	78	01.99-07.99		0 986 478 886	289 / 22	
Scudato 35 .10	2,8	76	01.99-12.03		0 986 478 886	289 / 22	
			08.02-12.03			BRB	0 986 424 833 29 121
49 .12	2,8	76	11.99-05.02		0 986 478 886	289 / 22	

LEYLAND-FREIGHT ROVER

Sherpa 230	1,7	45-52	11.86-12.95				
	1,8	38	11.86-12.95				
	2,0	63-66	11.86-12.95				
250	1,7	45-52	11.86-12.95				
	1,8	38	11.86-12.95				
	2,0	63-66	11.86-12.95				
280	1,7	45-52	11.86-12.95				
	1,8	38	11.86-12.95				
	2,0	63-66	11.86-12.95				
285	2,5	49	11.86-05.98				
310	2,5	49	11.86-12.98				
350	2,5	54	06.82-03.89				

MAZDA

Serie B [UF] 2500 12V D 4x4	2,5	57-63	03.96-05.99				
2600 i 12V 4x4	2,6	92	03.96-05.99				
Serie E 2.0	2,0	60-63	12.87-09.94				
			12.87-03.95	OZB			
2.0i	2,0	70	08.91-04.97				
2.0 4WD	2,0	60-63	12.87-07.89				
2.2 D	2,2	44-47	12.87-04.97	OZB			
			01.88-04.97				
2.2 D 4WD	2,2	44-47	01.88-04.97				

						0986 487 347	254 X 70				
17,0											
						0986 487 375	254 X 90				
17,0											
						0986 487 375	254 X 90				
						0986 487 287	254 X 90				
						0986 487 375	254 X 90				
						0986 487 375	254 X 90				
17,0											
						0986 487 232	229 X 44,5	1987 475 187			
						0986 487 232	229 X 44,5	1987 475 187			
						0986 487 232	229 X 44,5	1987 475 187			
						0986 487 232	229 X 44,5	1987 475 187			
						0986 487 232	229 X 44,5	1987 475 187			
						0986 487 232	229 X 44,5	1987 475 187			
						0986 487 232	229 X 44,5	1987 475 187			
						0986 487 232	229 X 44,5	1987 475 187			
						0986 487 232	229 X 44,5	1987 475 187			
						0986 487 347	254 X 70				
						0986 487 347	254 X 70				
						0986 487 347	254 X 70				
						0986 487 435	260 X 50				
						0986 487 435	260 X 50				
						0986 487 359	260 X 50				
						0986 487 359	260 X 50				
						0986 487 359	260 X 50				
						0986 487 359	260 X 50				
						0986 487 359	260 X 50				
						0986 487 359	260 X 50				
						0986 487 359	260 X 50				





MERCEDES-BENZ

MB 100	2,0	43	12.80-06.89					
100 D	2,4	53-56	09.87-08.91					
		55	09.91-01.96					
120	2,4	55	01.87-12.90					
130	2,4	53	12.80-09.83					
140	2,4	53	10.83-12.86					
		56	01.87-06.90					
150	2,4	53	12.80-09.83					
160	2,4	56	01.87-06.90					
170	2,4	53	12.80-09.83					
180	2,4	53	10.83-12.86					
		56	01.87-01.96					
Sprinter 310 D	2,5	70	09.96-05.01	INB	0 986 478 555	285 / 22		
311 CDI	2,2	80	06.01-12.04	INB	0 986 478 555	285 / 22		
					0 986 478 433	272 / 16		
							ATE, 0 986 424 832	29 153
							BSY,TEX	
		Comp. no. 504016/01	06.01-12.04	MTS,TNK TNK				
		Comp. no. 504016/02	06.01-12.04	MTS,TNK TNK				
		Rear axle →L 874988 →X 304860 →Z 161213	06.01-12.04	258	0 986 478 863	258 / 12		
		Rear axle L 874989→ X 304861→ Z 161214→	06.01-12.04	258	0 986 478 863	258 / 12		
		Rear axle 741.407	06.01-12.04	258			ATE 0 986 424 463	21 621
		Rear axle 741.408	06.01-12.04	272,TEJ 272			ATE 0 986 424 219	21 592
							BSY, 0 986 424 516	23 021
							FDO	
312 D	2,5	77	10.99-05.01	INB	0 986 478 555	285 / 22		
				258			ATE 0 986 424 463	21 621
				272	0 986 478 433	272 / 16	BSY 0 986 424 516	23 021
				272,TEJ			ATE 0 986 424 219	21 592
		Comp. no. 504016/01	10.99-05.01	MTS,TNK TNK				
		Comp. no. 504016/02	10.99-05.01	MTS,TNK TNK				
		Rear axle →L 874988 →X 304860 →Z 161213	10.99-05.01	258	0 986 478 863	258 / 12		
		Rear axle L 874989→ X 304861→ Z 161214→	10.99-05.01	258	0 986 478 863	258 / 12		
		85	08.99-05.01	INB	0 986 478 555	285 / 22		
				258			ATE 0 986 424 463	21 621
				272	0 986 478 433	272 / 16	BSY 0 986 424 516	23 021
				272,TEJ			ATE 0 986 424 219	21 592
		Comp. no. 504016/01	08.99-05.01	MTS,TNK TNK				
		Comp. no. 504016/02	08.99-05.01	MTS,TNK TNK				
		Rear axle →L 874988 →X 304860 →Z 161213	08.99-05.01	258	0 986 478 863	258 / 12		
		Rear axle L 874989→ X 304861→ Z 161214→	08.99-05.01	258	0 986 478 863	258 / 12		





◀ MERCEDES-BENZ

Sprinter 313 CDI	2,2	95	06.01→	INB	0986 478 555	285 / 22							
				285				ATE, 0986 424 832	29 153				
				Comp. no. 504016/01	06.01→	MTS,TNK							
				Comp. no. 504016/02	06.01→	MTS,TNK							
				Rear axle →L 874988 →X 304860 →Z 161213	06.01→	258	0986 478 863	258 / 12					
				Rear axle →L 874988 →X 304860 →Z 161213 →I 040000 →7 027519	06.01→	272	0986 478 433	272 / 16					
				Rear axle L 874989→ X 304861→ Z 161214→	06.01→	258	0986 478 863	258 / 12					
				Rear axle L 874989→ X 304861→ Z 161214→ I 040000→7 027520→	06.01→	272	0986 478 433	272 / 16					
				Rear axle 741.407	06.01→	258			ATE	0986 424 463	21 621		
				Rear axle 741.408	06.01→	272,TEJ			ATE	0986 424 219	21 592		
						272			BSY,	0986 424 516	23 021		
									FDO				
412 D	2,5	85	10.99-05.01	INB	0986 478 555	285 / 22							
				258				ATE	0986 424 463	21 621			
				272	0986 478 433	272 / 16	BSY	0986 424 516	23 021				
				272,TEJ			ATE	0986 424 219	21 592				
				Comp. no. 504016/01	10.99-05.01	MTS,TNK							
				Comp. no. 504016/02	10.99-05.01	MTS,TNK							
				Rear axle →L 874988 →X 304860 →Z 161213	10.99-05.01	258	0986 478 863	258 / 12					
				Rear axle L 874989→ X 304861→ Z 161214→	10.99-05.01	258	0986 478 863	258 / 12					
				Sprinter [NCV3] 209 CDI	2,1	65	04.06→		0986 479 295	298 / 16	BSY	0986 494 123	29190
								MTS					
				211 CDI	2,1	80	04.06→		0986 479 295	298 / 16	BSY	0986 494 123	29190
								MTS					
213 CDI	2,1	95	04.06→		0986 479 295	298 / 16	BSY	0986 494 123	29190				
				MTS									
215 CDI	2,1	110	04.06→		0986 479 295	298 / 16	BSY	0986 494 123	29190				
				MTS									
218 CDI	3,0	135	04.06→		0986 479 295	298 / 16	BSY	0986 494 123	29190				
				MTS									
224	3,5	190	04.06→		0986 479 295	298 / 16	BSY	0986 494 123	29190				
				MTS									
309 CDI	2,1	65	04.06→		0986 479 295	298 / 16	BSY	0986 494 123	29190				
				MTS									
311 CDI	2,1	80	04.06→		0986 479 295	298 / 16	BSY	0986 494 123	29190				
				MTS									
313 CDI	2,1	95	04.06→		0986 479 295	298 / 16	BSY	0986 494 123	29190				
				MTS									
315 CDI	2,1	110	04.06→		0986 479 295	298 / 16	BSY	0986 494 123	29190				
				MTS									
318 CDI	3,0	135	04.06→		0986 479 295	298 / 16	BSY	0986 494 123	29190				
				MTS									
324	3,5	190	04.06→		0986 479 295	298 / 16	BSY	0986 494 123	29190				
				MTS									
411 CDI	2,1	80	04.06→		0986 479 295	298 / 16	BSY	0986 494 123	29190				
				MTS									
415 CDI	2,1	110	04.06→		0986 479 295	298 / 16	BSY	0986 494 123	29190				
				MTS									
418 CDI	3,0	135	04.06→		0986 479 295	298 / 16	BSY	0986 494 123	29190				
				MTS									





◀ MERCEDES-BENZ

Sprinter [NCV3] 424	3,5	190	04.06→		0986 479 295	298 / 16	BSY	0986 494 123	29190
				MTS					
509 CDI	2,1	65	04.06→						
			Rear axle 741.412	04.06→	0986 479 295	298 / 16	BSY	0986 494 123	29190
				MTS					
			Rear axle 741.414; 741.416	04.06→	0986 479 296	303 / 28	BSY	0986 494 122	29217
511 CDI	2,1	80	04.06→						
			Rear axle 741.412	04.06→	0986 479 295	298 / 16	BSY	0986 494 123	29190
				MTS					
			Rear axle 741.414; 741.416	04.06→	0986 479 296	303 / 28	BSY	0986 494 122	29217
515 CDI	2,1	110	04.06→						
			Rear axle 741.412	04.06→	0986 479 295	298 / 16	BSY	0986 494 123	29190
				MTS					
			Rear axle 741.414; 741.416	04.06→	0986 479 296	303 / 28	BSY	0986 494 122	29217
518 CDI	3,0	135	04.06→						
			Rear axle 741.412	04.06→	0986 479 295	298 / 16	BSY	0986 494 123	29190
				MTS					
			Rear axle 741.414; 741.416	04.06→	0986 479 296	303 / 28	BSY	0986 494 122	29217
524	3,5	190	04.06→						
			Rear axle 741.412	04.06→	0986 479 295	298 / 16	BSY	0986 494 123	29190
				MTS					
			Rear axle 741.414; 741.416	04.06→	0986 479 296	303 / 28	BSY	0986 494 122	29217
Sprinter [T1N] 208 CDI	2,2	60	04.00-05.06	MTS					
				258			ATE	0986 424 463	21 621
				272			BSY	0986 424 516	23 021
				272,TEJ			ATE	0986 424 219	21 592
				285			ATE	0986 424 832	29 153
			Rear axle →L 874988 →X 304860 →Z 161213 →I 040000 →7 027515	04.00-05.06	0986 478 863	258 / 12			
			Rear axle L 874989→ X 304861→ Z 161214→ I 040001→ 7 027520→	04.00-05.06	0986 478 863	258 / 12			
208 D	2,3	58-60	02.95-03.00	MTS					
				258			ATE	0986 424 463	21 621
				272			BSY	0986 424 516	23 021
				272,TEJ			ATE	0986 424 219	21 592
				285			ATE	0986 424 832	29 153
			Rear axle →L 874988 →X 304860 →Z 161213 →I 040000 →7 027515	02.95-03.00	0986 478 863	258 / 12			
			Rear axle L 874989→ X 304861→ Z 161214→ I 040001→ 7 027520→	02.95-03.00	0986 478 863	258 / 12			
210 D	2,9	75	01.97-03.00	MTS					
				258			ATE	0986 424 463	21 621
				272			BSY	0986 424 516	23 021
				272,TEJ			ATE	0986 424 219	21 592
				285			ATE	0986 424 832	29 153
			Rear axle →L 874988 →X 304860 →Z 161213 →I 040000 →7 027515	01.97-03.00	0986 478 863	258 / 12			
			Rear axle L 874989→ X 304861→ Z 161214→ I 040001→ 7 027520→	01.97-03.00	0986 478 863	258 / 12			





◀ MERCEDES-BENZ

Sprinter [T1N] 211 CDI	2,2	80	04.00-05.06	MTS				
				258		ATE	0986 424 463	21 621
				272		BSY	0986 424 516	23 021
				272,TEJ		ATE	0986 424 219	21 592
				285		ATE	0986 424 832	29 153
			Rear axle →L 874988 →X 304860 →Z 161213 →I 040000 →7 027515	04.00-05.06	0986 478 863	258 / 12		
			Rear axle L 874989→ X 304861→ Z 161214→ I 040001→ 7 027520→	04.00-05.06	0986 478 863	258 / 12		
212 D	2,9	90	02.95-03.00	MTS				
				258		ATE	0986 424 463	21 621
				272		BSY	0986 424 516	23 021
				272,TEJ		ATE	0986 424 219	21 592
				285		ATE	0986 424 832	29 153
			Rear axle →L 874988 →X 304860 →Z 161213 →I 040000 →7 027515	02.95-03.00	0986 478 863	258 / 12		
			Rear axle L 874989→ X 304861→ Z 161214→ I 040001→ 7 027520→	02.95-03.00	0986 478 863	258 / 12		
213 CDI	2,2	95	04.00-05.06	MTS				
				258		ATE	0986 424 463	21 621
				272		BSY	0986 424 516	23 021
				272,TEJ		ATE	0986 424 219	21 592
				285		ATE	0986 424 832	29 153
			Rear axle →L 874988 →X 304860 →Z 161213 →I 040000 →7 027515	04.00-05.06	0986 478 863	258 / 12		
			Rear axle L 874989→ X 304861→ Z 161214→ I 040001→ 7 027520→	04.00-05.06	0986 478 863	258 / 12		
214	2,3	105	02.95-03.00	MTS				
				258		ATE	0986 424 463	21 621
				272		BSY	0986 424 516	23 021
				272,TEJ		ATE	0986 424 219	21 592
				285		ATE	0986 424 832	29 153
			Rear axle →L 874988 →X 304860 →Z 161213 →I 040000 →7 027515	02.95-03.00	0986 478 863	258 / 12		
			Rear axle L 874989→ X 304861→ Z 161214→ I 040001→ 7 027520→	02.95-03.00	0986 478 863	258 / 12		
105-108			04.00-05.06	MTS				
				258		ATE	0986 424 463	21 621
				272		BSY	0986 424 516	23 021
				272,TEJ		ATE	0986 424 219	21 592
				285		ATE	0986 424 832	29 153
			Rear axle →L 874988 →X 304860 →Z 161213 →I 040000 →7 027515	04.00-05.06	0986 478 863	258 / 12		
			Rear axle L 874989→ X 304861→ Z 161214→ I 040001→ 7 027520→	04.00-05.06	0986 478 863	258 / 12		



						S				S		
												0 986 487 610
17,0												
19,0												
18,5												
20,0												
												0 986 487 610
17,0												
19,0												
18,5												
20,0												
												0 986 487 610
17,0												
19,0												
18,5												
20,0												
												0 986 487 610
17,0												
19,0												
18,5												
20,0												



M



◀ MERCEDES-BENZ

Sprinter [T1N] 214 NGT	2,3	95	04.00-05.06	MTS				
				258		ATE	0986 424 463	21 621
				272		BSY	0986 424 516	23 021
				272,TEJ		ATE	0986 424 219	21 592
				285		ATE	0986 424 832	29 153
			Rear axle →L 874988 →X 304860 →Z 161213 →I 040000 →7 027515	04.00-05.06	0986 478 863	258 / 12		
			Rear axle L 874989→ X 304861→ Z 161214→ I 040001→ 7 027520→	04.00-05.06	0986 478 863	258 / 12		
216 CDI	2,7	115	04.00-05.06	MTS				
				258		ATE	0986 424 463	21 621
				272		BSY	0986 424 516	23 021
				272,TEJ		ATE	0986 424 219	21 592
				285		ATE	0986 424 832	29 153
			Rear axle →L 874988 →X 304860 →Z 161213 →I 040000 →7 027515	04.00-05.06	0986 478 863	258 / 12		
			Rear axle L 874989→ X 304861→ Z 161214→ I 040001→ 7 027520→	04.00-05.06	0986 478 863	258 / 12		
308 CDI	2,2	60	04.00-05.06		0986 478 433	272 / 16		
				MTS				
				258		ATE	0986 424 463	21 621
				272		BSY	0986 424 516	23 021
				272,TEJ		ATE	0986 424 219	21 592
			285		ATE	0986 424 832	29 153	
308 D	2,3	58	02.95-03.00		0986 478 433	272 / 16		
				MTS				
				258		ATE	0986 424 463	21 621
				272		BSY	0986 424 516	23 021
				272,TEJ		ATE	0986 424 219	21 592
			285		ATE	0986 424 832	29 153	
308 D James Cook	2,3	58	02.95-03.00		0986 478 433	272 / 16		
				MTS				
				258		ATE	0986 424 463	21 621
				272		BSY	0986 424 516	23 021
				272,TEJ		ATE	0986 424 219	21 592
			285		ATE	0986 424 832	29 153	
310 D	2,9	75	01.97-03.00		0986 478 433	272 / 16		
				MTS				
				258		ATE	0986 424 463	21 621
				272		BSY	0986 424 516	23 021
				272,TEJ		ATE	0986 424 219	21 592
			285		ATE	0986 424 832	29 153	
310 D James Cook	2,9	75	01.97-03.00		0986 478 433	272 / 16		
				MTS				
				258		ATE	0986 424 463	21 621
				272		BSY	0986 424 516	23 021
				272,TEJ		ATE	0986 424 219	21 592
			285		ATE	0986 424 832	29 153	
311 CDI	2,1	80	08.02-05.06		0986 478 433	272 / 16		
				MTS				
				258		ATE	0986 424 463	21 621
				272		BSY	0986 424 516	23 021
				272,TEJ		ATE	0986 424 219	21 592
			285		ATE	0986 424 832	29 153	



					S				S		
											0 986 487 610
17,0											
19,0											
18,5											
20,0											
											0 986 487 610
17,0											
19,0											
18,5											
20,0											
											0 986 487 610
17,0											
19,0											
18,5											
20,0											
											0 986 487 610
17,0											
19,0											
18,5											
20,0											
											0 986 487 610
17,0											
19,0											
18,5											
20,0											
											0 986 487 610
17,0											
19,0											
18,5											
20,0											
											0 986 487 610





◀ MERCEDES-BENZ

Sprinter [T1N] 311 CDI	2,2	80	04.00-05.06	0 986 478 433	272/16		
			MTS				
			258			ATE	0 986 424 463 21 621
			272			BSY	0 986 424 516 23 021
			272,TEJ			ATE	0 986 424 219 21 592
			285			ATE	0 986 424 832 29 153
312 D	2,9	90	02.95-03.00	0 986 478 433	272/16		
			MTS				
			258			ATE	0 986 424 463 21 621
			272			BSY	0 986 424 516 23 021
			272,TEJ			ATE	0 986 424 219 21 592
			285			ATE	0 986 424 832 29 153
312 D James Cook	2,9	90	02.95-03.00	0 986 478 433	272/16		
			MTS				
			258			ATE	0 986 424 463 21 621
			272			BSY	0 986 424 516 23 021
			272,TEJ			ATE	0 986 424 219 21 592
			285			ATE	0 986 424 832 29 153
313 CDI	2,2	95	04.00-05.06	0 986 478 433	272/16		
			MTS				
			258			ATE	0 986 424 463 21 621
			272			BSY	0 986 424 516 23 021
			272,TEJ			ATE	0 986 424 219 21 592
			285			ATE	0 986 424 832 29 153
			08.02-05.06	0 986 478 433	272/16		
			MTS				
			258			ATE	0 986 424 463 21 621
			272			BSY	0 986 424 516 23 021
			272,TEJ			ATE	0 986 424 219 21 592
			285			ATE	0 986 424 832 29 153
314	2,3	105	02.95-03.00	0 986 478 433	272/16		
			MTS				
			258			ATE	0 986 424 463 21 621
			272			BSY	0 986 424 516 23 021
			272,TEJ			ATE	0 986 424 219 21 592
			285			ATE	0 986 424 832 29 153
		105-108	04.00-05.06	0 986 478 433	272/16		
			MTS				
			258			ATE	0 986 424 463 21 621
			272			BSY	0 986 424 516 23 021
			272,TEJ			ATE	0 986 424 219 21 592
			285			ATE	0 986 424 832 29 153
314 James Cook	2,3	105	02.95-08.02	0 986 478 433	272/16		
			MTS				
			258			ATE	0 986 424 463 21 621
			272			BSY	0 986 424 516 23 021
			272,TEJ			ATE	0 986 424 219 21 592
			285			ATE	0 986 424 832 29 153
		105-108	08.02-05.06	0 986 478 433	272/16		
			MTS				
			258			ATE	0 986 424 463 21 621
			272			BSY	0 986 424 516 23 021
			272,TEJ			ATE	0 986 424 219 21 592
			285			ATE	0 986 424 832 29 153
314 NGT	2,3	95	04.00-05.06	0 986 478 433	272/16		
			MTS				
			258			ATE	0 986 424 463 21 621
			272			BSY	0 986 424 516 23 021
			272,TEJ			ATE	0 986 424 219 21 592
			285			ATE	0 986 424 832 29 153



						S	()			S		
												0 986 487 610
17,0												
19,0												
18,5												
20,0												
												0 986 487 610
17,0												
19,0												
18,5												
20,0												
												0 986 487 610
17,0												
19,0												
18,5												
20,0												
												0 986 487 610
17,0												
19,0												
18,5												
20,0												
												0 986 487 610
17,0												
19,0												
18,5												
20,0												
												0 986 487 610
17,0												
19,0												
18,5												
20,0												
												0 986 487 610
17,0												
19,0												
18,5												
20,0												
												0 986 487 610





◀ MERCEDES-BENZ

Sprinter [T1N] 316 CDI	2,7	115	04.00-05.06		0 986 478 433	272 / 16			
				MTS					
				258			ATE	0 986 424 463	21 621
				272			BSY	0 986 424 516	23 021
				272,TEJ			ATE	0 986 424 219	21 592
				285			ATE	0 986 424 832	29 153
			10.04-05.06		0 986 478 433	272 / 16			
				MTS					
				258			ATE	0 986 424 463	21 621
				272			BSY	0 986 424 516	23 021
				272,TEJ			ATE	0 986 424 219	21 592
				285			ATE	0 986 424 832	29 153
	2,7	115	04.01-05.06		0 986 478 433	272 / 16			
				MTS					
				258			ATE	0 986 424 463	21 621
				272			BSY	0 986 424 516	23 021
				272,TEJ			ATE	0 986 424 219	21 592
				285			ATE	0 986 424 832	29 153
408 CDI	2,2	60	04.00-05.06	INB	0 986 478 555	285 / 22			
				MTS					
				258			ATE	0 986 424 463	21 621
				272			BSY	0 986 424 516	23 021
				272,TEJ			ATE	0 986 424 219	21 592
				285			ATE	0 986 424 832	29 153
408 D	2,3	58	02.95-03.00	INB	0 986 478 555	285 / 22			
				MTS					
				258			ATE	0 986 424 463	21 621
				272			BSY	0 986 424 516	23 021
				272,TEJ			ATE	0 986 424 219	21 592
				285			ATE	0 986 424 832	29 153
410 D	2,9	75	01.97-03.00	INB	0 986 478 555	285 / 22			
				MTS					
				258			ATE	0 986 424 463	21 621
				272			BSY	0 986 424 516	23 021
				272,TEJ			ATE	0 986 424 219	21 592
				285			ATE	0 986 424 832	29 153
411 CDI	2,2	80	04.00-05.06	INB	0 986 478 555	285 / 22			
				MTS					
				258			ATE	0 986 424 463	21 621
				272			BSY	0 986 424 516	23 021
				272,TEJ			ATE	0 986 424 219	21 592
				285			ATE	0 986 424 832	29 153
412 D	2,9	90	02.95-03.00	INB	0 986 478 555	285 / 22			
				MTS					
				258			ATE	0 986 424 463	21 621
				272			BSY	0 986 424 516	23 021
				272,TEJ			ATE	0 986 424 219	21 592
				285			ATE	0 986 424 832	29 153
413 CDI	2,2	95	04.00-05.06	INB	0 986 478 555	285 / 22			
				MTS					
				258			ATE	0 986 424 463	21 621
				272			BSY	0 986 424 516	23 021
				272,TEJ			ATE	0 986 424 219	21 592
				285			ATE	0 986 424 832	29 153
414	2,3	105	02.95-03.00	INB	0 986 478 555	285 / 22			
				MTS					
				258			ATE	0 986 424 463	21 621
				272			BSY	0 986 424 516	23 021
				272,TEJ			ATE	0 986 424 219	21 592
				285			ATE	0 986 424 832	29 153



					S				S		
											0 986 487 610
17,0											
19,0											
18,5											
20,0											
											0 986 487 610
17,0											
19,0											
18,5											
20,0											
											0 986 487 610
17,0											
19,0											
18,5											
20,0											
											0 986 487 611
17,0											
19,0											
18,5											
20,0											
											0 986 487 611
17,0											
19,0											
18,5											
20,0											
											0 986 487 611
17,0											
19,0											
18,5											
20,0											
											0 986 487 611
17,0											
19,0											
18,5											
20,0											
											0 986 487 611
17,0											
19,0											
18,5											
20,0											
											0 986 487 611



					S				S		
											0 986 487 611
17,0											
19,0											
18,5											
20,0											
											0 986 487 611
17,0											
19,0											
18,5											
20,0											
											0 986 487 611
17,0											
19,0											
18,5											
20,0											
											1 987 475 263
											0 986 487 610
											0 986 487 610
											0 986 487 611
20,0											
21,5											
											1 987 475 263
											0 986 487 610
20,0											
											0 986 487 610
											0 986 487 611
20,0											
21,5											
											1 987 475 263
											0 986 487 610
20,0											
											0 986 487 610
											0 986 487 611
20,0											
21,5											
											1 987 475 263
											0 986 487 610
20,0											
											0 986 487 610
											0 986 487 611
20,0											
21,5											





◀ MERCEDES-BENZ

Vario [T2W] 614 D	4,2	100	09.96-09.06	MTS			
			Comp. no. 504016/01	09.96-09.06	MTS,TNK		
			Comp. no. 504016/02	09.96-09.06	MTS,TNK		
			Rear axle 741.131	09.96-09.06		ATE	0 986 424 832 29 153
			Rear axle 742.501,505	09.96-09.06		GIR	0 986 468 350 29 835
615 D	4,2	110	01.01-09.06	MTS			
			Comp. no. 504016/01	01.01-09.06	MTS,TNK		
			Comp. no. 504016/02	01.01-09.06	MTS,TNK		
			Rear axle 741.131	01.01-09.06		ATE	0 986 424 832 29 153
			Rear axle 742.501,505	01.01-09.06		GIR	0 986 468 350 29 835
		112	10.98-01.01	MTS			
			Comp. no. 504016/01	10.98-01.01	MTS,TNK		
			Comp. no. 504016/02	10.98-01.01	MTS,TNK		
			Rear axle 741.131	10.98-01.01		ATE	0 986 424 832 29 153
			Rear axle 742.501,505	10.98-01.01		GIR	0 986 468 350 29 835
618 D	4,2	130	06.03-09.06	MTS			
			Comp. no. 504016/01	06.03-09.06	MTS,TNK		
			Comp. no. 504016/02	06.03-09.06	MTS,TNK		
			Rear axle 741.131	06.03-09.06		ATE	0 986 424 832 29 153
			Rear axle 742.501,505	06.03-09.06		GIR	0 986 468 350 29 835
810 DT	4,2	75	09.96-09.06	MTS			
			Comp. no. 504016/01	09.96-09.06	MTS,TNK		
			Comp. no. 504016/02	09.96-09.06	MTS,TNK		
			Rear axle 741.131	09.96-09.06		ATE	0 986 424 832 29 153
			Rear axle 742.501,505	09.96-09.06		GIR	0 986 468 350 29 835
812 D	2,9	90	09.96-09.06	MTS PET		ATE, BSY,TEX	0 986 424 832 29 153
			Comp. no. 504016/01	09.96-09.06	MTS,TNK		
			Comp. no. 504016/02	09.96-09.06	MTS,TNK		
			Rear axle 741.131	09.96-09.06		ATE	0 986 424 832 29 153
			Rear axle 742.501,505	09.96-09.06		GIR	0 986 468 350 29 835
814 D	4,2	100	09.96-09.06	MTS			
			Comp. no. 504016/01	09.96-09.06	MTS,TNK		
			Comp. no. 504016/02	09.96-09.06	MTS,TNK		
			Rear axle 741.131	09.96-09.06		ATE	0 986 424 832 29 153
			Rear axle 742.501,505	09.96-09.06		GIR	0 986 468 350 29 835
814 DA	4,2	100-112	09.96-01.01	MTS			
			Comp. no. 504016/01	09.96-01.01	MTS,TNK		
			Comp. no. 504016/02	09.96-01.01	MTS,TNK		
			Rear axle 741.131	09.96-01.01		ATE	0 986 424 832 29 153
			Rear axle 742.501,505	09.96-01.01		GIR	0 986 468 350 29 835
815 D	4,2	110	01.01-09.06	MTS			
			Comp. no. 504016/01	01.01-09.06	MTS,TNK		
			Comp. no. 504016/02	01.01-09.06	MTS,TNK		
			Rear axle 741.131	01.01-09.06		ATE	0 986 424 832 29 153
			Rear axle 742.501,505	01.01-09.06		GIR	0 986 468 350 29 835
		110-112	09.96-01.01	MTS			
			Comp. no. 504016/01	09.96-01.01	MTS,TNK		
			Comp. no. 504016/02	09.96-01.01	MTS,TNK		
			Rear axle 741.131	09.96-01.01		ATE	0 986 424 832 29 153
			Rear axle 742.501,505	09.96-01.01		GIR	0 986 468 350 29 835



					S				S		
											1 987 475 263
											0 986 487 610
											0 986 487 610
											0 986 487 611
20,0											
21,5											
											1 987 475 263
											0 986 487 610
											0 986 487 610
											0 986 487 611
20,0											
21,5											
											1 987 475 263
											0 986 487 610
											0 986 487 610
											0 986 487 611
20,0											
21,5											
											1 987 475 263
											0 986 487 610
											0 986 487 610
											0 986 487 611
20,0											
21,5											
											1 987 475 263
											0 986 487 610
											0 986 487 610
											0 986 487 611
20,0											
21,5											
											1 987 475 263
											0 986 487 610
											0 986 487 610
											0 986 487 611
20,0											
21,5											
											1 987 475 263
											0 986 487 610
											0 986 487 610
											0 986 487 611
20,0											
21,5											
											1 987 475 263
											0 986 487 610
											0 986 487 610
											0 986 487 611
20,0											
21,5											





◀ MERCEDES-BENZ

Vario [T2W] 815 DA	4,2	112	01.96-01.01	MTS					
			Comp. no. 504016/01	01.96-01.01	MTS,TNK				
			Comp. no. 504016/02	01.96-01.01	MTS,TNK				
			Rear axle 741.131	01.96-01.01		ATE	0 986 424 832	29 153	
			Rear axle 742.501,505	01.96-01.01		GIR	0 986 468 350	29 835	
818 D	4,2	130	06.03-09.06	MTS					
			Comp. no. 504016/01	06.03-09.06	MTS,TNK				
			Comp. no. 504016/02	06.03-09.06	MTS,TNK				
			Rear axle 741.131	06.03-09.06		ATE	0 986 424 832	29 153	
			Rear axle 742.501,505	06.03-09.06		GIR	0 986 468 350	29 835	
Vito [638 TON] 108 CDI, 110 CDI	2,2	60/75	04.99-09.03	GFR,ITB	0 986 478 873	280 / 10	ATE	0 986 494 000	21 904
							BSY, JUR	0 986 460 002	23 020
				MTS					
108 D	2,3	60	11.95-09.03	GFR,ITB	0 986 478 873	280 / 10	ATE	0 986 494 000	21 904
							BSY, JUR	0 986 460 002	23 020
				MTS					
110 D	2,3	72	11.95-09.03	GFR,ITB	0 986 478 873	280 / 10	ATE	0 986 494 000	21 904
							BSY, JUR	0 986 460 002	23 020
				MTS					
112 CDI	2,2	90	04.99-09.03	GFR,ITB	0 986 478 873	280 / 10	ATE	0 986 494 000	21 904
							BSY, JUR	0 986 460 002	23 020
				MTS					
113	2,0	95	11.95-09.03	GFR,ITB	0 986 478 873	280 / 10	BSY, JUR	0 986 460 002	23 020
				MTS					
				GFR,ITB				0 986 494 000	21 904
				MTS					
		100	11.95-09.03	GFR,ITB	0 986 478 873	280 / 10	ATE	0 986 494 000	21 904
							BSY, JUR	0 986 460 002	23 020
				MTS					
114	2,3	105	11.95-09.03	FER	0 986 478 873	280 / 10	BSY, JUR	0 986 460 002	23 020
				GFR,ITB				0 986 494 000	21 904
				MTS					
Vito [639 TON] 109 CDI	2,1	65	10.03-10.06		0 986 479 138	296 / 10	BSY	0 986 494 082	24008
		70	11.06→		0 986 479 138	296 / 10	BSY	0 986 494 082	24008
111 CDI	2,1	80	10.03-10.06		0 986 479 138	296 / 10	BSY	0 986 494 082	24008
		85	11.06→		0 986 479 138	296 / 10	BSY	0 986 494 082	24008
115 CDI	2,1	110	10.03→		0 986 479 138	296 / 10	BSY	0 986 494 082	24008
119	3,2	140	10.03→		0 986 479 138	296 / 10	BSY	0 986 494 082	24008
120 CDI	3,0	150	04.06→		0 986 479 138	296 / 10	BSY	0 986 494 082	24008
122	3,2	160	10.03→		0 986 479 138	296 / 10	BSY	0 986 494 082	24008



						S				S		
												1 987 475 263
												0 986 487 610
												0 986 487 610
												0 986 487 611
20,0												
21,5												
												1 987 475 263
												0 986 487 610
												0 986 487 610
												0 986 487 611
20,0												
21,5												
16,3												
17,8												
												0 986 487 605
16,3												
17,8												
												0 986 487 605
16,3												
17,8												
												0 986 487 605
16,3												
17,8												
												0 986 487 605
16,3												
17,8												
												0 986 487 605
16,3												
17,8												
												0 986 487 605
16,3												
17,8												
												0 986 487 605
16,3												
17,8												
												0 986 487 605
16,3												
17,8												
												0 986 487 605
16,3												
17,8												
												0 986 487 605
16,3												
17,8												
												0 986 487 605
16,3												
17,8												
												0 986 487 605
16,3												
17,8												
												0 986 487 605
16,3												
17,8												
												0 986 487 605
16,3												
17,8												
												0 986 487 605
16,3												
17,8												
												0 986 487 605
16,3												
17,8												
												0 986 487 605
16,3												
17,8												
												0 986 487 605
16,3												
17,8												
												0 986 487 605
16,3												
17,8												
												0 986 487 605
16,3												
17,8												
												0 986 487 605
16,3												
17,8												
												0 986 487 605
16,3												
17,8												
												0 986 487 605
16,3												
17,8												
												0 986 487 605
16,3												
17,8												
												0 986 487 605
16,3												
17,8												
												0 986 487 605
16,3												
17,8												
												0 986 487 605
16,3												
17,8												
												0 986 487 605
16,3												
17,8												
												0 986 487 605
16,3												
17,8												
												0 986 487 605
16,3												
17,8												
												0 986 487 605
16,3												
17,8												
												0 986 487 605
16,3												
17,8												
												0 986 487 605
16,3												
17,8												
												0 986 487 605
16,3												
17,8												
												0 986 487 605
16,3												
17,8												
												0 986 487 605
16,3												
17,8												
												0 986 487 605
16,3												
17,8												
												0 986 487 605
16,3												
17,8												
												0 986 487 605
16,3												
17,8												
												0 986 487 605
16,3												
17,8												
												0 986 487 605
16,3												
17,8												
												0 986 487 605
16,3												
17,8												
												0 986 487 605
16,3												
17,8												
												0 986 487 605
16,3												
17,8												
												0 986 487 605
16,3												
17,8												
												0 986 487 605
16,3												
17,8												



◀ MERCEDES-BENZ

Vito [639 TON] 123	3,7	170		06.04-08.07	0986 479 138	296 / 10	BSY	0986 494 082	24008
126	3,5	190		09.07→	0986 479 138	296 / 10	BSY	0986 494 082	24008
2t 207 D	2,4	53	Fg.no. HA→BM:741.400,401	09.82-01.89					
			Fg.no. HA→BM:741.404, 405,436	09.82-01.89					
208 D	2,3	58-60	Fg.no. HA→BM:741.400,401	10.88-06.95					
			Fg.no. HA→BM:741.404, 405,436	10.88-06.95					
209 D	3,0	65	Fg.no. HA→BM:741.400,401	09.82-01.89					
			Fg.no. HA→BM:741.404, 405,436	09.82-01.89					
210	2,3	70-77	Fg.no. HA→BM:741.400,401	08.82-06.95					
			Fg.no. HA→BM:741.404, 405,436	08.82-06.95					
210 D	2,9	70-72	Fg.no. HA→BM:741.400,401	10.88-06.95					
			Fg.no. HA→BM:741.404, 405,436	10.88-06.95					
3t 307 D	2,4	53		09.82-01.89					
308 D	2,3	58-60		10.88-06.95					
309 D	3,0	65		09.82-01.89					
310	2,3	70-77		08.82-06.95					
310 D	2,9	70-72		10.88-06.95					

MITSUBISHI

Canter 35 [FB] 2.3 D	2,3	49		01.86-01.90					
L 200 2.5 D Turbo	2,5	64		08.97-12.03					
L 200 [K0/K1/K2/K3] 1.6	1,6	48		11.86-03.95					
2.0 2WD	2,0	65		11.86-05.95					
2.0 4WD	2,0	65		11.86-05.94					
2.4 i 2WD	2,4	82		06.90-11.97					
2.4 i 4WD	2,4	82		06.94-11.97					
2.5 D Turbo 4WD	2,5	73		11.92-03.01					
2.5 D 2WD	2,5	54		10.84-05.96					
2.5 D 4WD	2,5	54		12.87-10.92					
2.6	2,6	76		11.89-05.95					
3.0 i V6	3,0	110		06.90-05.91					
L 200 [K6/K7] 2.0 i 16V	2,0	90		01.96-01.00					
2.4 i 4WD	2,4	97		01.96→					
2.5 D	2,5	64		01.96-06.01					
2.5 D Turbo Interc. 2WD	2,5	74-85		01.96→					
2.5 D Turbo Interc. 4WD	2,5	73-85		01.96→					
2.5 D 2WD	2,5	55-64		06.95-06.01					
2.5 D 4WD	2,5	64		01.96-06.01					
2.8 D	2,8	92		06.95→					
2.8 D 4WD	2,8	92		11.96→					
L 300 [L] 2.3 D Wagon	2,3	49-50		04.83-10.86					
L 300 [P]	2,5	62-64		12.87-05.96					
2.5 D Turbo 4WD Wagon									
L 300 Truck [L] 1.6	1,6	48		04.83-10.86					
		48-51		11.86-05.94					
2.3 D	2,3	49-50		04.83-10.86					
2.5 D	2,5	52		11.86-05.94					
L 300 Truck [P] 2.0 i 16V	2,0	85		06.94-04.00					
2.0 16V	2,0	65		06.94-05.96					
2.5 D Turbo	2,5	64		06.94-12.01					
L 300 Van [L] 1.6 2WD	1,6	48		04.83-10.86					
				06.86-10.86					
1.6 4WD	1,6	48		06.86-10.86					
2.0 4WD	2,0	75		01.85-10.86					
2.3 D	2,3	49-50		04.83-10.86					



◀ MITSUBISHI

L 300 Van [P] 1.6 2WD	1,6	48-51	11.86-05.94					
2.0 i 2WD	2,0	65	06.94-12.01					
2.0 2WD	2,0	65	11.86-10.88					
		66	11.88-06.95					
2.0 4WD	2,0	65	11.86-10.92					
2.4 i 2WD	2,4	82	11.91-05.94					
2.4 i 4WD	2,4	80	11.86-10.88					
		82	11.88-05.94					
2.5 D Turbo 4WD	2,5	62-64	11.88-12.01					
2.5 D 2WD	2,5	51	11.86-12.00					
L 300 Wagon [L] 1.6	1,6	48	04.83-10.86					
1.8 4WD	1,8	72	04.83-12.85					
2.0 4WD	2,0	75	01.85-10.86					
L 300 Wagon [P] 1.6	1,6	48-51	11.86-05.94					
2.0 i 2WD	2,0	83	06.96-08.97					
2.0 2WD	2,0	65	11.86-10.88					
		66	11.86-06.95					
2.0 4WD	2,0	65	11.86-06.93					
2.4 i 2WD	2,4	82	11.90-05.96					
2.4 i 4WD	2,4	80	11.86-10.88					
		82	11.88-06.95					
2.5 D 2WD long	2,5	51	11.86-12.00					
2.5 D 2WD short	2,5	51	11.86-08.97					
L 400 2.0 i	2,0	83-85	12.94-03.01	FKR				
				FLR				
2.4 i	2,4	97	12.94-03.01					
2.5 D Turbo 2WD	2,5	64	12.94-03.01	FKR				
				FLR				
2.5 D Turbo 4WD	2,5	64	12.94-03.01					
Pajero Van 2.5 D Turbo 4WD	2,5	77	01.91-07.93			AKE	0 986 461 768	21 842
2.8 D Turbo 4WD	2,8	92	07.93-09.99			AKE	0 986 461 768	21 842

NISSAN

Cabstar 2.0	2,0	66	01.82-08.86					
2.5 D	2,5		01.82-08.86					
Cabstar [F22] 1.6	1,6	62	10.86-12.89	LN6,TW				
2.0	2,0	74	10.86-12.89	LN6,TW				
2.2	2,2	79	10.86-12.89	LN6,TW				
2.3 D	2,3	54	01.82-12.89	LN6				
2.5 D	2,5	57	01.82-12.89	LN6				
2.7 D	2,7	66	10.86-12.89	LN6,TW				
2.8	2,8	97	10.86-12.89	LN6,TW				
3.3 D Turbo	3,3	91	10.86-12.89	LN6,TW				
Cabstar [F23] 2.0	2,0	66	07.92-05.94					
2.5 D	2,5	59	07.92-05.96	OZB				
Hardbody [NP300]	2,5	98	01.06→					
2.5 D Turbo 4x4								
Interstar [X70]	1,9	59-60	07.02→				0 986 494 043	23 669
1.9 D Turbo dCi 80								
2.2 D Turbo dCi 90	2,2	66	07.02→				0 986 494 043	23 669
2.5 D Turbo dCi 100	2,5	73-74	11.03→				0 986 494 043	23 669
2.5 D Turbo dCi 120	2,5	84-88	07.02→				0 986 494 043	23 669
3.0 D Turbo dCi 140	3,0	99-100	11.03→				0 986 494 043	23 669
Kubistar [X76] 1.2 i 8V	1,1	44	07.03→	ERH				
				NON				
1.2 i 16V	1,1	55-56	07.03→	ERH				
				NON				
1.4 i	1,4	55	07.03→	ERH				
				NON				
1.5 D Turbo 60	1,5	40-42	07.03→	ERH				
				NON				



◀ NISSAN

Kubistar [X76]	1,5	48-50	07.03→	ERH				
1.5 D Turbo 70				NON				
1.5 D Turbo 80	1,5	59-62	07.03→	ERH				
				NON				
1.6 i	1,6	70-71	07.03→	ERH				
				NON				
Pickup [D21] 2.0	2,0	64	04.92-05.94					
		65	11.89-09.95					
		66	10.88-04.92					
2.4	2,4	74	10.88-04.92					
2.4 i	2,4	91-93	04.92-02.98					
2.4 i 2WD	2,4	93	03.92-01.97					
2.4 i 4WD	2,4	74	11.88-04.92					
		93	03.92-01.97					
2.4 4WD	2,4	74	10.88-04.92					
2.5 D	2,5	59-63	10.88-02.98					
2.5 D 4WD	2,5	59-63	10.88-04.92					
Pickup [D22] 2.4 i	2,4	88	02.98-11.01	DOP				
2.4 i 4WD	2,4	88	02.98-11.01					
		93	02.97→					
		98	11.01-01.07					
2.5 D Turbo	2,5	98	11.01-01.07	SA				
	2,5	76	05.98-11.01					
2.5 D Turbo 4WD		98	11.01-01.08					
2.5 dCi 4x4	2,5	98	02.08→					
3.2 D 4WD	3,2		02.97→					
Primastar [X83] 1.9 dCi 80	1,9	59-60	07.02→		0986 479 144	280/12	0986 494 040	23980
1.9 dCi 100	1,9	74	07.02→		0986 479 144	280/12	0986 494 040	23980
2.0 dCi 90	2,0	66	09.06→		0986 479 144	280/12	0986 494 040	23980
2.0 dCi 120	2,0	84-85	09.06→		0986 479 144	280/12	0986 494 040	23980
2.0 i	2,0	88	02.03→		0986 479 144	280/12	0986 494 040	23980
2.5 dCi 140	2,5	99	09.03→		0986 479 144	280/12	0986 494 040	23980
2.5 dCi 150	2,5	107-110	09.06→		0986 479 144	280/12	0986 494 040	23980
Trade 2.0D	2,0	41	03.87-12.98					
		46	03.87-12.98					
2.8D	2,8	57-60	03.87-12.98					
			04.91-12.98	FGS				
Urvan [E24] 2.0	2,0	64	11.86-01.95					
		64-66	02.87-07.94					
2.3D	2,3	53	02.87-12.88					
		55	11.86-03.89					
2.4	2,4	74	11.86-06.97					
2.4 i	2,4	74-76	05.89-11.95					
2.5D	2,5	59	12.88-05.97					
				WW				
		63	03.89-06.97					
				WW				
Vanette [C120] 1.5	1,5	51	06.81-06.87					
				BZU				
2.0	2,0	64-66	06.81-06.87					
				BZU				
2.0D	2,0	48-49	06.81-06.87					
				BZU				
Vanette [C220] 1.5	1,5	51	09.85-06.94	TW				
			04.87-04.88	BZU				
2.0D	2,0	44	04.87-04.88					
				BZU				
		47-49	12.87-04.88					
				BZU				
Vanette [GC22] 1.5	1,5	51	09.86-03.93					
				WW				
2.0	2,0	64	09.86-03.93					
		66	05.86-04.93					





◀ NISSAN

Vanette [GC22] 2.0 D	2,0	47-49	09.86-03.93						
				WW					
2.4	2,4	74	06.86-10.91						
2.4 i	2,4	74-77	09.86-03.93						
Vanette Cargo [C23M] 1.6 i	1,6	71-72	07.92-11.01						
			12.97-07.99	KHD,TW					
2.0 D	2,0	49	07.92-09.94						
2.3 D	2,3	55	09.94-11.01						

OPEL

Arena 1.9 D	1,9	44	03.98-08.01	ABO					
Campo Pick-Up [TF0] 2.2 D	2,2	39-45	08.87-09.96						
2.3	2,3	65-69	09.91-09.96						
2.3 i	2,3	69-72	09.91-09.96						
2.5 D	2,5	56	02.89-08.97						
2.5 TD	2,5	56	10.89-08.97						
3.1 TD	3,1	80	03.95-08.97						
Campo Pick-Up [TF1] 2.5 DI	2,5	56	03.97-08.01	AA					
				NAA					
2.5 DTI	2,5	74	08.01-08.03	AA					
				NAA					
3.1 TDS	3,1	80	03.97-08.02	AA					
				NAA					
Combo 1.2 i	1,2	33	09.94-10.01						
1.4 i	1,4	44	09.94-10.01						
		60	09.94-10.01						
		66	08.99-10.01						
1.7 D	1,7	44	09.94-10.01						
Combo [Tour] 1.3 CDTI	1,3	51	09.04-09.07						
				ABO					
					GIR	0 986 424 646	23 417		
				26D	0 986 479 191	264 / 10			
				336	0 986 478 731	240 / 10			
		Fg.no. ab 22000001→	09.04-09.07						
		55	10.05→						
				ABO					
					GIR	0 986 424 646	23 417		
				26D	0 986 479 191	264 / 10			
				336	0 986 478 731	240 / 10			
		Fg.no. ab 22000001→	10.05→						
1.4 i Twinport	1,4	66	09.04→						
				ABO					
					GIR	0 986 424 646	23 417		
				26D	0 986 479 191	264 / 10			
				336	0 986 478 731	240 / 10			
		Fg.no. ab 22000001→	09.04→						
1.6 CNG	1,6	69	06.06→						
				ABO					
					GIR	0 986 424 646	23 417		
				26D	0 986 479 191	264 / 10			
				336	0 986 478 731	240 / 10			
		69-71	04.05→						
				ABO					
					GIR	0 986 424 646	23 417		
				26D	0 986 479 191	264 / 10			
				336	0 986 478 731	240 / 10			





◀ OPEL

Combo [Tour] 1.6 i	1,6	64	10.01-08.04	ABO				
							GIR	0 986 424 646 23 417
				26D	0 986 479 191	264 / 10		
				336	0 986 478 731	240 / 10		
			Fg.no. ab 22000001→	10.01-08.04				
1.7 CDTI	1,7	74	09.04→	ABO				
							GIR	0 986 424 646 23 417
				26D	0 986 479 191	264 / 10		
				336	0 986 478 731	240 / 10		
			Fg.no. ab 22000001→	09.04→				
1.7 DI	1,7	48	10.01-08.04	ABO				
							GIR	0 986 424 646 23 417
				26D	0 986 479 191	264 / 10		
				336	0 986 478 731	240 / 10		
			Fg.no. ab 22000001→	09.04→				
1.7 DTI	1,7	55	10.01-08.04	ABO				
							GIR	0 986 424 646 23 417
				26D	0 986 479 191	264 / 10		
				336	0 986 478 731	240 / 10		
			Fg.no. ab 22000001→	10.01-08.04				
Euromidi 2.0	2,0	74	09.88-08.96	MC2,SAL				
2.0 DT	2,0	51	09.88-08.96	MC2,SAL				
2.2 D	2,2	45	09.88-08.96	MC2,SAL				
2.4 DT	2,4	56	09.88-08.96	MC2,SAL				
Movano 1.9 D	1,9	59	01.99-10.01		0 986 478 970	305 / 12	0 986 494 043	23 669
1.9 DTI	1,9	60	10.01-10.05		0 986 478 970	305 / 12	0 986 494 043	23 669
2.2 DTI	2,2	66	09.00-10.05		0 986 478 970	305 / 12	0 986 494 043	23 669
2.5 D	2,5	59	10.98-09.01		0 986 478 970	305 / 12	0 986 494 043	23 669
2.5 DTI	2,5	73-74	10.01→		0 986 478 970	305 / 12	0 986 494 043	23 669
		84	10.01-10.07		0 986 478 970	305 / 12	0 986 494 043	23 669
		88	08.06→		0 986 478 970	305 / 12	0 986 494 043	23 669
		107	08.06→		0 986 478 970	305 / 12	0 986 494 043	23 669
2.8 DTI	2,8	84	06.98-09.02		0 986 478 970	305 / 12	0 986 494 043	23 669
3.0 CDTI	3,0	100	03.03-10.05		0 986 478 970	305 / 12	0 986 494 043	23 669
Vivaro 1.9 CDTI	1,9	60	03.01-08.06	BSM	0 986 479 271	280 / 12		
				WW,XXX			0 986 494 040	23 980
			Fg.no. →6V699999	03.01-08.06			0 986 494 040	23 980
			→6Y999999					
1.9 DTI	1,9	74	03.01-08.06	BSM	0 986 479 271	280 / 12		
				WW,XXX			0 986 494 040	23 980
			Fg.no. →6V699999	03.01-08.06			0 986 494 040	23 980
			→6Y999999					
2.0 CDTI	2,0	66	08.06→	BSM	0 986 479 271	280 / 12		
				WW,XXX			0 986 494 040	23 980
			Fg.no. →6V699999	08.06→			0 986 494 040	23 980
			→6Y999999					
		84	08.06→	BSM	0 986 479 271	280 / 12		
				WW,XXX			0 986 494 040	23 980
			Fg.no. →6V699999	08.06→			0 986 494 040	23 980
			→6Y999999					
2.0 16V	2,0	86-88	03.01→	BSM	0 986 479 271	280 / 12		
				WW,XXX			0 986 494 040	23 980
			Fg.no. →6V699999	03.01→			0 986 494 040	23 980
			→6Y999999					
2.5 CDTI	2,5	84	08.06-06.08	BSM	0 986 479 271	280 / 12		
				WW,XXX			0 986 494 040	23 980
			Fg.no. →6V699999	08.06-06.08			0 986 494 040	23 980
			→6Y999999					



◀ OPEL

Vivaro 2.5 CDTI	2,5	99	09.02-08.06	BSM WW,XXX	0 986 479 271	280 / 12		
			Fg.no. →6V699999 →6Y999999	09.02-08.06			0 986 494 040	23 980
		107	08.06→	BSM WW,XXX	0 986 479 271	280 / 12		
			Fg.no. →6V699999 →6Y999999	08.06→			0 986 494 040	23 980

PEUGEOT

Bipper [A9] 1.4 HDi	1,4	50	02.08→					
1.4 i	1,4	54	02.08→					
Boxer 2.8 D	2,8	66	03.02-08.05					
				L02	0 986 479 066	280 / 16	BRB	0 986 494 049 23 921
				L03	0 986 479 065	280 / 16		
2.8 D Interc.	2,8	90	03.02-08.05					
				L02	0 986 479 066	280 / 16	BRB	0 986 494 049 23 921
				L03	0 986 479 065	280 / 16		
2.8 D Turbo	2,8	77	01.02-08.05					
				L02	0 986 479 066	280 / 16	BRB	0 986 494 049 23 921
				L03	0 986 479 065	280 / 16		
2.8 HDi	2,8	93	09.05→					
				L02	0 986 479 066	280 / 16	BRB	0 986 494 049 23 921
				L03	0 986 479 065	280 / 16		
Boxer [U3] 1.9 D	1,9	50	07.98-02.02	D25,L06 D27,L07 D28,L02 L02 L03				
		51	02.94-02.02	D25,L06 D27,L07 D28,L02 L02 L03				
1.9 D Turbo	1,9	66/68	02.94-02.02	D25,L06 D27,L07 D28,L02 L02 L03				
2.0	2,0	79	02.94-02.02	D25,L06 D27,L07 D28,L02 L02 L03				
2.0 HDi	2,0	62	09.01-02.02	D25,L06 D27,L07 D28,L02 L02 L03				
2.0 i	2,0	80	02.94-02.02	D25,L06 D27,L07 D28,L02 L02 L03				





◀ PEUGEOT

Boxer [U3] 2.5 D	2,5	62	01.99-02.02	D25,L06			
				D27,L07			
				D28,L02			
				L02			
				L03			
		63	02.94-02.02	D25,L06			
				D27,L07			
				D28,L02			
				L02			
				L03			
2.5 D Turbo	2,5	76	02.94-02.02	D25,L06			
				D27,L07			
				D28,L02			
				L02			
				L03			
2.5 TDi	2,5	79	10.96-02.02	D25,L06			
				D27,L07			
				D28,L02			
				L02			
				L03			
2.8 D	2,8	64	01.99-02.02	D25,L06			
				D27,L07			
				D28,L02			
				L02			
				L03			
2.8 D Turbo	2,8	90	10.99-02.02	D25,L06			
				D27,L07			
				D28,L02			
				L02			
				L03			
2.8 HDi	2,8	94	09.00-02.02	D25,L06			
				D27,L07			
				D28,L02			
				L02			
				L03			
Boxer [U5] 2.0 HDi	2,0	62	02.02→		BRB	0 986 494 049	23 921
				L02		0 986 479 066	280 / 16
				L03		0 986 479 065	280 / 16
				MTS			
2.0 i	2,0	80	02.02→		BRB	0 986 494 049	23 921
				L02		0 986 479 066	280 / 16
				L03		0 986 479 065	280 / 16
				MTS			
2.2 HDi	2,2	74	02.02→		BRB	0 986 494 049	23 921
				L02		0 986 479 066	280 / 16
				L03		0 986 479 065	280 / 16
				MTS			
2.8 D Turbo	2,8	90	02.02→		BRB	0 986 494 049	23 921
				L02		0 986 479 066	280 / 16
				L03		0 986 479 065	280 / 16
				MTS			
2.8 HDi	2,8	94	02.02→		BRB	0 986 494 049	23 921
				L02		0 986 479 066	280 / 16
				L03		0 986 479 065	280 / 16
				MTS			





◀ PEUGEOT

Boxer [U5] 2.8 HDi	2,8	107	08.04→			BRB	0 986 494 049	23 921
				L02	0 986 479 066		280 / 16	
				L03	0 986 479 065		280 / 16	
				MTS				
Boxer [U9] 2.2 HDi	2,2	74	06.06→		0 986 479 316		280 / 16	
					0 986 479 317		300 / 16	
					0 986 479 399		280 / 16	BSY 0 986 494 110 24465
				MTS				
		88	06.06→		0 986 479 316		280 / 16	
					0 986 479 317		300 / 16	
					0 986 479 399		280 / 16	BSY 0 986 494 110 24465
				MTS				
3.0 HDi	3,0	115	06.06→		0 986 479 316		280 / 16	
					0 986 479 317		300 / 16	
					0 986 479 399		280 / 16	BSY 0 986 494 110 24465
				MTS				
Expert [G9] 1.6 HDi	1,6	66	02.07→		0 986 479 379		290 / 14	
2.0 HDi	2,0	88/100	02.07→		0 986 479 379		290 / 14	
2.0 i 16V	2,0	103	02.07→		0 986 479 379		290 / 14	
Expert [U64] 1.6 i	1,6	58	09.95→					
1.8 i	1,8	70	09.96→					
1.9 D	1,9	51	09.95→					
		52	09.01→					
1.9 D Turbo	1,9	66-68	09.95→					
		68	09.95→					
2.0 HDi	2,0	70	10.99→					
		80	10.99→					
		81	06.00→					
2.0 i 16V	2,0	100	03.00→					
J5 1.8	1,8	49-51	09.81-12.93					
				D25				
				D27				
				L02				
				L03				
				222				
1.9 D	1,9	51	11.87-12.93					
				D25				
				D27				
				L02				
				L03				
				222				
			08.90-12.93	L02				
1.9 D Turbo	1,9	60	08.92-12.93					
				D25				
				D27				
				L02				
				L03				
2.0	2,0	55-63	09.81-12.93					
				D25				
				D27				
				L02				
				L03				
			08.90-12.93	L02				
		62	07.87-12.93					
				D25				
				D27				
				L02				
				L03				
			08.90-12.93	L02				



20,1			0 986 477 031 254,5 X 64						1 987 475 319		
				LOC	0 986 487 701	254 X 57				LOC	0 204 114 646
											0 986 487 712
19,0											0 986 487 726
19,0											0 986 487 726
19,0											0 986 487 726
						0 986 487 522	254 X 57				
			0 986 477 144 255 X 85		0 986 487 545	255 X 60		1 987 475 251		0 204 114 112	
			0 986 477 144 255 X 85		0 986 487 545	255 X 60		1 987 475 251		0 204 114 112	
			0 986 477 144 255 X 85		0 986 487 545	255 X 60		1 987 475 251		0 204 114 112	
			0 986 477 144 255 X 85		0 986 487 545	255 X 60		1 987 475 251		0 204 114 112	
			0 986 477 144 255 X 85		0 986 487 545	255 X 60		1 987 475 251		0 204 114 112	
			0 986 477 144 255 X 85		0 986 487 545	255 X 60		1 987 475 251		0 204 114 112	
			0 986 477 144 255 X 85		0 986 487 545	255 X 60		1 987 475 251		0 204 114 112	
			0 986 477 144 255 X 85		0 986 487 545	255 X 60		1 987 475 251		0 204 114 112	
			0 986 477 144 255 X 85		0 986 487 545	255 X 60		1 987 475 251		0 204 114 112	
			0 986 477 144 255 X 85		0 986 487 545	255 X 60		1 987 475 251		0 204 114 112	
			0 986 477 031 254,5 X 64							0 204 114 508	
										0 204 114 530	
					0 986 487 313	254 X 57		1 987 475 214			
					0 986 487 499	300 X 57		1 987 475 214			
					0 986 487 128	254 X 57		1 987 475 092			
			0 986 477 031 254,5 X 64							0 204 114 531	
										0 204 114 508	
										0 204 114 530	
					0 986 487 313	254 X 57		1 987 475 214			
					0 986 487 128	254 X 57		1 987 475 092			
					0 986 487 499	300 X 57		1 987 475 214		0 204 114 531	
			0 986 477 031 254,5 X 64							0 204 114 508	
										0 204 114 530	
					0 986 487 313	254 X 57		1 987 475 214			
					0 986 487 499	300 X 57		1 987 475 214			
					0 986 487 128	254 X 57		1 987 475 092			
			0 986 477 031 254,5 X 64							0 204 114 508	
										0 204 114 530	
					0 986 487 313	254 X 57		1 987 475 214			
					0 986 487 128	254 X 57		1 987 475 092			
					0 986 487 499	300 X 57		1 987 475 214		0 204 114 531	
			0 986 477 031 254,5 X 64							0 204 114 508	
										0 204 114 530	
					0 986 487 313	254 X 57		1 987 475 214			
					0 986 487 128	254 X 57		1 987 475 092			
					0 986 487 499	300 X 57		1 987 475 214		0 204 114 531	
			0 986 477 031 254,5 X 64							0 204 114 508	
										0 204 114 530	
					0 986 487 313	254 X 57		1 987 475 214			
					0 986 487 128	254 X 57		1 987 475 092			
					0 986 487 499	300 X 57		1 987 475 214		0 204 114 531	





◀ PEUGEOT

J5	2.0	2,0	72	07.87-12.93						
					D25					
					D27					
					L02					
					L03					
	2.5 D	2,5	54-55	09.81-12.93						
					D25					
					D27					
					L02					
					L03					
				08.90-12.93	L02					
	2.5 D Turbo	2,5	70	07.87-12.93						
					D25					
					D27					
					L02					
					L03					
				08.90-12.93	L02					
J9	1.6	1,6	43	10.80-09.85	D25					
				10.80-06.87						
	2.0	2,0	55	10.80-09.85	D25					
				10.80-06.87						
	2.1 D	2,1	41	10.80-09.85	D25					
				10.80-06.87						
	2.3 D	2,3	49	10.80-10.82						
					D25					
	2.5 D	2,5	53	07.82-09.85	D25					
				07.82-06.87						
Partner 1.8i		1,8	66	10.99-12.03						
					ABO					
Partner [B9] 1.6 HDi		1,6	55	05.08→		0 986 479 383	267/12			
					BSM	0 986 479 387	267/12			
			66	05.08→		0 986 479 383	267/12			
					BSM	0 986 479 387	267/12			
			80	05.08→		0 986 479 383	267/12			
					BSM	0 986 479 387	267/12			
	1.6 i 16V	1,6	66	05.08→		0 986 479 383	267/12			
					BSM	0 986 479 387	267/12			
			80	05.08→		0 986 479 383	267/12			
					BSM	0 986 479 387	267/12			
Partner [M4] Electrique			24	01.98-08.02						
	1.1 i	1,1	44	07.96-08.02						
	1.4	1,4	51-52	11.96-08.02						
	1.4 i	1,4	55	07.96-08.02						
	1.6 i 16V	1,6	80	09.00-08.02						
	1.8 D	1,8	43-44	07.96-08.02						
	1.8 i	1,8	66	03.97-08.02						
	1.9 D	1,9	50	07.96-08.02						
			51	07.96-08.02						
			52	09.00-08.02						
	2.0 HDi	2,0	66	12.99-08.02						
Partner [M5] 1.1 i		1,1	44	09.02→						
	1.4 i	1,4	55	09.02→						
	1.6 HDi	1,6	55	09.05→						
			66	09.05→		0 986 478 608	246,7/9	GIR	0 986 461 769	20 961
	1.6 i 16V	1,6	80	09.02→		0 986 478 608	246,7/9	GIR	0 986 461 769	20 961
	1.9 D	1,9	52	09.02→						
	2.0 HDi	2,0	66	09.02→		0 986 478 608	246,7/9	GIR	0 986 461 769	20 961
Ranch [M4] 1.4 i		1,4	55	07.97→						
	1.9 D	1,9	51	07.97-10.98						
				11.98→						





◀ PEUGEOT

205 Pickup 1.1	1,1	40		10.87-12.90	BKV BTR B30			
					LWG OBK WW			
1.8D	1,8	44		05.85-09.98	BKV BTR B30			
					LWG OBK WW			
504 Pickup 1.6	1,6	45	Fg.no. S 3.610.001→	09.81-12.90	LWG			
1.8	1,8	50	Fg.no. S 3.610.001→	07.84-12.89	LWG			
		53	Fg.no. S 3.610.001→	07.84-12.89	LWG			
1.9D	1,9	36	Fg.no. S 3.610.001→	09.81-06.87	LWG			
2.0	2,0	68-71	Fg.no. S 3.610.001→	09.81-12.89	LWG			
2.1D	2,1	48	Fg.no. S 3.610.001→	09.81-12.90	LWG			
2.3D	2,3	51	Fg.no. S 3.610.001→	07.84-12.89	LWG			
2.5D	2,5	55	Fg.no. S 3.610.001→	07.87-12.89	LWG			

RENAULT

Clio I [X57] 1.2 i	1,2	40-41		06.90-02.98	ABO 0986 478 442 238/8 ABO,BTR ABS 0986 478 866 238/8 ABS,BTS 0986 479 281 238/8			BSY 0986 461 149 21 597
		44		01.94-03.96	ABO ABO,BTR LWG			
1.4	1,4	55-57		01.94-03.96	ABO 0986 478 442 238/8 ABO,BTR ABS 0986 478 866 238/8 ABS,BTS 0986 479 281 238/8			LWG
Express, Extra, Rapid [F40] Electrique		21		09.94-09.97	D20 222			
	1,0	21		06.96-10.97	D20 DM3 222			





◀ RENAULT

Express, Extra, Rapid [F40] 1.0	1,0	27-30	03.86-08.91	BTE,D10		
				BTR,D10		
				D10		
				D20		
				D30		
1.1	1,1	33	06.87-08.91	BTE,D10		
				BTR,D10		
				D10		
				D20		
				D30		
34			03.86-08.91	BTE,D10		
				BTR,D10		
				D10		
				D20		
				D30		
36			09.91-09.96	BTE,D10		
				BTR,D10		
				D10		
				D20		
				D30		
09.91-10.97			09.91-10.97	BTE,D10		
				BTR,D10		
				D20		
				D30		
				222		
10.96-10.97			10.96-10.97	D30		
1.2	40		09.91-09.96	BTE,D10		
				BTR,D10		
				D20		
				D30		
				DM3		
1.2i	1,2	40	09.91-10.97	D20		
				D30		
				Z09		
				10.96-10.97	D20	
				D30		
10.96-10.97			10.96-10.97	DM3		
				Z09		





◀ RENAULT

Express, Extra, Rapid [F40] 1.4	1,4	43	03.86-08.91	D20							
				D30							
				Z09							
				09.91-09.97			D20				
				D30							
				DM3							
				Z09							
				44			06.87-09.97	D20			
				D30							
				DM3							
Z09											
1.4 i	1,4	44	03.86-08.91	D20							
				D30							
				DM3							
				Z09							
				09.91-03.97			D20				
				D30							
				DM3							
				Z09							
				55-59			09.91-10.97	D20			
				D30							
DM3											
Z09											
1.6 D	1,6	40	03.86-06.86	D10							
				03.86-03.97			BTE,D10				
				BTR,D10							
				D20							
				D30							
				DM3							
				Z09							
				07.86-03.97			DM3				
				10.87-03.97			BTE,D10				
				BTR,D10							
D20											
D30											
DM3											
Z09											
1.9 D	1,9	40	09.94-09.97	D20							
				D30							
				DM3							
				Z09							
				47-48			09.91-10.97	D20			
				D30							
				DM3							
				Z09							
				Kangoo I [FC./KC.] 1.0 i			1,0	43	09.98-04.03		
									09.98-12.07		
02.01-12.07											
1.0 i 16V	1,0	50	02.01-12.07								





◀ RENAULT

Kangoo I [FC./KC.] 1.2 GPL	1,2	44	10.97-12.07	DM1 DM3				
1.2i	1,2	44	10.97-12.07	DM1 DM3				
			03.02-12.07					
1.2i 16V	1,2	55	05.00-12.07	DM1 DM3				
			04.04-12.07	DM1 DM3				
1.4i	1,4	55	10.97-12.07	DM1 DM3				
1.5 DCI	1,5		04.05-12.07	DM1 DM3				
		48	05.00-12.07	DM1 DM3				
			05.03-12.07	DM3				
		50	04.05-12.07	DM1 DM3				
		60	02.01-12.07	DM1 DM3				
			05.03-12.07	DM3				
		62	04.05-12.07	DM1 DM3				
1.6i	1,6	66	09.99-04.03 09.99-12.07					
		70	06.00-12.07	DM1 DM3				
			09.01-04.03 09.01-12.07					
				DM3				
			01.03-04.03 01.03-12.07					
			05.03-12.07	DM3				
1.6i 4x4	1,6	70	06.00-12.07		0986 479 195	280,5 / 12	BSY	0986 424 671 40 118
1.9D	1,9	40	10.97-12.07	DM1 DM3				
		47	01.98-12.07	DM1 DM3				
			05.03-12.07	DM3				
		47-48	10.97-04.03 10.97-12.07	DM3 DM1 DM3				
			01.98-12.07	DM1 DM3				
			05.03-12.07	DM3				
1.9D DCI	1,9	59	05.00-12.07	DM1 DM3				
			05.03-12.07	DM3				
1.9D DCI 4x4	1,9	59	05.00-12.07		0986 479 195	280,5 / 12	BSY	0986 424 671 40 118
1.9D DTI	1,9	59	09.98-12.07	DM1 DM3				
			02.00-12.07		0986 479 195	280,5 / 12	BSY	0986 424 671 40 118





◀ RENAULT

Kangoo II [FW./KW.]	1.5 DCI	50	01.08→	FKL					
		63	01.08→	FKL					
		76	01.08→	FKL					
		78	01.08→	FKL					
1.6 i	1.6	64	01.08→	FKL					
		78	01.08→	FKL					
Master P28 -35	2.0	58	10.86-09.97						
		59	10.82-09.86						
P28 -35D	2.4	52	09.80-11.90						
T28 -35	2.0	57-59	10.80-09.86						
			10.86-09.97						
		2,2	67	09.80-09.97					
		2,4	55	01.94-09.97					
		2,5	69	01.94-09.97					
		T28 -35D	2,1	44	09.80-09.97				
				52-55	09.80-09.97				
55	09.80-09.97								
2,5	69			09.80-09.97					
		72	09.80-09.97						
2.5 dCi 100	2,5	74	11.06→		0986 478 970	305/12	0986 494 043	23 669	
2.5 dCi 120	2,5	88	11.06→		0986 478 970	305/12	0986 494 043	23 669	
2.5 dCi 120 FAP	2,5	88	11.06→		0986 478 970	305/12	0986 494 043	23 669	
2.5 dCi 150 FAP	2,5	107	11.06→		0986 478 970	305/12	0986 494 043	23 669	
Master [X70] 1.9 dCi 80	1.9	60	05.00-09.03		0986 478 970	305/12	0986 494 043	23 669	
			04.01-10.06		0986 478 970	305/12	0986 494 043	23 669	
1.9 dTi 80	1.9	58	01.00-09.03		0986 478 970	305/12	0986 494 043	23 669	
			02.01-09.03		0986 478 970	305/12	0986 494 043	23 669	
2.2 dCi 90	2,2	66	01.00-09.03		0986 478 970	305/12	0986 494 043	23 669	
			10.03-10.06		0986 478 970	305/12	0986 494 043	23 669	
2.5 D	2,5	60	10.97-09.03		0986 478 970	305/12	0986 494 043	23 669	
2.5 dCi 90	2,5	84	05.00-09.03		0986 478 970	305/12	0986 494 043	23 669	
2.5 dCi 100	2,5	73	10.03-10.06		0986 478 970	305/12	0986 494 043	23 669	
2.5 dCi 110	2,5	73	10.03-10.06		0986 478 970	305/12	0986 494 043	23 669	
2.5 dCi 120	2,5	84	07.02-10.06		0986 478 970	305/12	0986 494 043	23 669	
2.8 D	2,8	86	05.01-10.04		0986 478 970	305/12	0986 494 043	23 669	
2.8 dTi 110	2,8	84	10.97-09.03		0986 478 970	305/12	0986 494 043	23 669	
			01.98-09.03		0986 478 970	305/12	0986 494 043	23 669	
			06.01-09.03		0986 478 970	305/12	0986 494 043	23 669	
			10.97-09.03		0986 478 970	305/12	0986 494 043	23 669	
2.8 dTi 120	2,8	84	10.97-09.03		0986 478 970	305/12	0986 494 043	23 669	
3.0 dCi 140	3,0	100	10.03-10.06		0986 478 970	305/12	0986 494 043	23 669	
Traffic 1.4	1,4	36	09.80-02.89						
				D22					
				D23					
				D25					
			09.80-10.97						
				D22					
				D23					
				D25					
			09.80-08.84						
			09.80-02.89		D22				
					D23				
					D25				
09.84-02.89									
48		09.80-02.89							
			D22						
			D23						
			D25						
49		09.80-02.89							
			D22						
			D23						
			D25						





◀ RENAULT

Trafic 1.7	1,7	50	03.89-10.97	D22			
				D23			
				D25			
50-58			10.84-02.89	D22			
				D23			
				D25			
58			10.84-10.97	D22			
				D23			
				D25			
1.9D	1,9	47-48	11.97-05.01	ABO			
				ABO,D23			
				ABS			
				ABS,D25			
2.0	2,0	58-63	09.80-02.89	D22			
				D23			
				D25			
59			09.80-10.97	D22			
				D23			
				D25			
2.1D	2,1	43	09.80-10.97	D22			
				D23			
				D25			
47			09.94-10.97	D22			
				D23			
				D25			
2.2i	2,2	69-71	03.89-10.97	D22			
				D23			
				D25			
74			09.94-10.97	D22			
				D23			
				D25			
2.5D	2,5	52	09.80-09.81	D22			
				D23			
				D25			
52-55			10.81-02.89	D22			
				D23			
				D25			
55			03.89-10.97	D22			
				D23			
				D25			
2.5 D 4x4	2,5	55	11.97-05.01				
			11.97-05.01				
Trafic [EL./FL./JL.] 1.9 DCI	1,9	60	05.01-12.06		0986 479 144	280 / 12	0986 494 040 23 980
				BSM	0986 479 271	280 / 12	
				74	06.01-12.06	0986 479 144	280 / 12
2.0 DCI	2,0	66	01.06→	BSM	0986 479 271	280 / 12	
					0986 479 144	280 / 12	0986 494 040 23 980
				85	01.06→	0986 479 144	280 / 12
2.0 16V	2,0	86	02.06→	BSM	0986 479 271	280 / 12	
					0986 479 144	280 / 12	0986 494 040 23 980
				88	06.01-12.06	0986 479 144	280 / 12
				BSM	0986 479 271	280 / 12	



					S				S		
						BSY	0 986 487 332	255 X 46	1 987 475 152		
											0 204 114 031
											0 204 114 036
							0 986 487 547	254 X 57			0 204 114 550
						BSY	0 986 487 332	255 X 46	1 987 475 152		
											0 204 114 031
											0 204 114 036
							0 986 487 547	254 X 57			0 204 114 550
						BSY	0 986 487 332	255 X 46	1 987 475 152		
											0 204 114 031
											0 204 114 036
							0 986 487 547	254 X 57			0 204 114 550
							0 986 487 332	255 X 46	1 987 475 152		
											0 204 114 036
							0 986 487 547	254 X 57			0 204 114 550
						BSY	0 986 487 332	255 X 46	1 987 475 152		
											0 204 114 031
											0 204 114 036
							0 986 487 547	254 X 57			0 204 114 550
						BSY	0 986 487 332	255 X 46	1 987 475 152		
											0 204 114 031
											0 204 114 036
							0 986 487 547	254 X 57			0 204 114 550
						BSY	0 986 487 332	255 X 46	1 987 475 152		
											0 204 114 031
											0 204 114 036
							0 986 487 547	254 X 57			0 204 114 550
						BSY	0 986 487 332	255 X 46	1 987 475 152		
											0 204 114 031
											0 204 114 036
							0 986 487 547	254 X 57			0 204 114 550
						BSY	0 986 487 332	255 X 46	1 987 475 152		
											0 204 114 031
											0 204 114 036
							0 986 487 547	254 X 57			0 204 114 550
							0 986 487 547	254 X 57			0 204 114 550
							0 986 487 547	254 X 57			0 204 114 550
17,0											
17,0											
17,0											
17,0											
17,0											
17,0											





◀ RENAULT

Traffic [EL./FL./JL.] 2.5 DCI	2,5	98	06.02-12.06		0 986 479 144	280 / 12	0 986 494 040	23 980
				BSM	0 986 479 271	280 / 12		
		107	01.06→		0 986 479 144	280 / 12	0 986 494 040	23 980
				BSM	0 986 479 271	280 / 12		
4 (F4/F6) [R2106-R2430]	0,8	21,5	10.82-12.93			162		
						183		
	1,1	25	10.83-12.85			183		
			10.83-12.93					
				ZUB				
						183		

SEAT

Inca 1.6 EFI	1,6	66	11.98→					
Inca [6K9] 1.4	1,4	44	11.95-12.97					
			09.97-06.03					
			09.00-06.03					
			Fg.no. →9K..X..023 407	09.97-04.99				
			Fg.no. 9K..X..023 408→	05.99-06.03				
		55	09.00-06.03					
1.6	1,6	55	11.95-05.97					
			06.97-09.00					
			Fg.no. →9K..X..023 407	06.97-04.99				
			Fg.no. 9K..X..023 408→	05.99-09.00				
1.7 D	1,7	42	09.96-09.00					
			Fg.no. →9K..X..023 407	09.96-04.99				
			Fg.no. 9K..X..023 408→	05.99-09.00				
1.9 D	1,9	47	11.95-06.03					
			Fg.no. →9K..X..023 407	11.95-04.99				
			Fg.no. 9K..X..023 408→	05.99-06.03				
1.9 SDI	1,9	47	12.95-09.00					
			09.00-06.03					
			Fg.no. →9K..X..023 407	12.95-04.99				
			Fg.no. 9K..X..023 408→	05.99-09.00				
Terra 0.9	0,9	29	01.87-12.94					
1.3 D	1,3	33	03.90-12.94					
1.4 D	1,4	35	10.90-12.94					

SKODA

Pick-Up [6U7] 1.6 MPI	1,6	55	10.95-03.01					
				EFV				
				222				
1.9 D	1,9	47	01.96-03.01					
				EFV				
				222				
135	1,3	40	09.91-12.97					
				222				
			01.93-12.97	EFV				
		42	09.91-12.97					
				222				
			01.93-12.97	EFV				
		43	09.91-12.97					
				222				
			01.93-12.97	EFV				



Pick-Up [6U7] 135 i.e.	1,3	40	07.93-12.97
			EFV 222
135 MPI	1,3	40	08.96-03.01
			EFV 222
136 i.e.	1,3	50	07.93-12.97
			EFV 222
136 MPI	1,3	50	08.96-03.01
			EFV 222

SUBARU

Libero [FA] 1.2 i	1,2	40	05.93-11.98
1.2 i Transporter	1,2	40	05.93-04.94
1.2 i 4WD	1,2	40	05.93-11.98
1.2 i 4WD Transporter	1,2	40	05.93-04.94
			05.93-11.98
Libero [KJ] 1.2 4WD	1,2	38	10.87-12.89
			TW
700	0,7	27	10.83-12.93
			TW
			01.86-12.93
			TW,WW

SUZUKI

Carry 1.0	1,0	31	07.90-09.94
		33	04.88-09.94
Carry [ED] 1.0	1,0	33	10.85-03.99
Carry [FD] 1.3 16V	1,3	58	03.99-03.09
Carry [ST] 800	0,8	27	11.80-10.85
			WW
Carry Van 1.0	1,0	32-33	07.90-09.94
Carry Van [ED] 1.0	1,0	33	10.85-03.99
SJ 410 1.0	1,0	33	10.86-12.88
SJ 410 Pickup 1.0	1,0	33	09.81-12.88

TALBOT

Express [J 5] 1.8	1,8	50	09.81-12.93
1.9 D	1,9	51	11.87-12.93
2.0	2,0	57	09.81-12.93
		72	07.87-12.93
2.5 D	2,5	55	09.81-12.93
2.5 D Turbo	2,5	70	07.87-12.93
1100 1.1 City Laster	1,1	37-43	07.83-06.85
			10.83-06.85
			ZUB

TOYOTA

Dyna 100			08.85-08.87
1.8	1,8	57	08.85-08.87
			08.87-05.95
			SBR,VO
2.5 D	2,5	53	08.85-08.87
		55	08.85-05.95
			SBR,VO
Hiace [KLH] 2.5 D Turbo	2,5	65/75	08.01→
2.5 D Turbo 4WD	2,5	75	08.01→

			0 986 477 041	200 X 49,5							
							0 986 487 270	200 X 40			
										0 204 114 577	
			0 986 477 041	200 X 49,5							
							0 986 487 270	200 X 40			
										0 204 114 577	
			0 986 477 041	200 X 49,5							
							0 986 487 270	200 X 40			
										0 204 114 577	
			0 986 477 041	200 X 49,5							
							0 986 487 270	200 X 40			
										0 204 114 577	
							0 986 487 682	180 X 31			
							0 986 487 682	180 X 31			
							0 986 487 682	180 X 31			
							0 986 487 682	180 X 31			
							0 986 487 682	180 X 31			
							0 986 487 269	180 X 31	1 987 475 130		
							0 986 487 419	170 X 30			
							0 986 487 269	180 X 31	1 987 475 130		
							0 986 487 427	220 X 40			
							0 986 487 427	220 X 40			
							0 986 487 427	220 X 40			
							0 986 487 440	220 X 35	1 987 475 252		
							0 986 487 324	220 X 40	1 987 475 128		
							0 986 487 427	220 X 40			
							0 986 487 427	220 X 40			
							0 986 487 427	220 X 40			
							0 986 487 268	220 X 40	1 987 475 129		
							0 986 487 268	220 X 40	1 987 475 129		
			0 986 477 031	254,5 X 64			0 986 487 128	254 X 57	1 987 475 092		
			0 986 477 031	254,5 X 64			0 986 487 128	254 X 57	1 987 475 092		
			0 986 477 031	254,5 X 64			0 986 487 128	254 X 57	1 987 475 092		
			0 986 477 031	254,5 X 64			0 986 487 128	254 X 57	1 987 475 092		
			0 986 477 031	254,5 X 64			0 986 487 128	254 X 57	1 987 475 092		
			0 986 477 031	254,5 X 64			0 986 487 128	254 X 57	1 987 475 092		
							0 986 487 076	228,5 X 42	1 987 475 051		
					BSY		0 986 487 285	228,5 X 42			
									1 987 475 030		
							0 986 487 292	254 X 56			
							0 986 487 292	254 X 56			
							0 986 487 292	254 X 56			
							0 986 487 292	254 X 56			
							0 986 487 292	254 X 56			
							0 986 487 743	270 X 57			
							0 986 487 743	270 X 57			





◀ TOYOTA

Hiace [LH] 2.2 D	2,2	49	12.82-01.84	
2.4 D	2,4	62	08.82-08.89	
			12.82-01.89	
2.4 D 4WD	2,4	62	08.86-08.89	
Hiace [LXH] 2.4 D	2,4	62	08.95-08.01	
2.4 D Turbo	2,4	66	08.95-08.01	
2.4 D Turbo 4WD	2,4	66	08.96-08.01	
Hiace [RCH] 2.4	2,4	85	03.97→	
2.4 i	2,4	85	08.95→	
2.4 i 4WD	2,4	85	08.96-04.98	
2.7	2,7	105	04.98→	
2.7 4x4	2,7	105	04.98→	
Hiace [YH] 1.8	1,8	57	12.82-08.86	
2.0	2,0	65	08.86-07.87	
			08.87-03.88	
			09.88-08.89	
2.2	2,2	69	08.86-08.87	
2.2 4WD	2,2	69	12.86-07.87	
			08.87-08.89	
Hiace Pickup 1.6	1,6	49	11.82-07.85	
2.2 D	2,2	49	11.82-07.85	
Hiace Truck 2.0	2,0	65	05.95-10.96	
Hiace Van [LH] 2.4 D	2,4	62	08.89-08.93	LLE
2.4 D 4WD	2,4	62	08.89-08.93	LLE
2.8 D	2,8	58	08.89-08.93	LLE
Hiace Van [LXH] 2.4 D Turbo	2,4	66	08.96-08.01	
Hiace Van [ZH] 2.0	2,0	74	08.89-08.93	
2.4	2,4	84	08.89-02.06	
2.4 i	2,4	88	08.89-02.05	
2.4 i 4WD	2,4	88	08.89-08.93	
			09.93-07.95	
Hiace Wagon [LH] 2.4 D	2,4	62	08.89-08.93	LLE
2.8 D	2,8	58	08.89-08.93	LLE
3.0 D	3,0	65	08.98-02.06	
Hiace Wagon [ZH] 2.4 i	2,4	88	08.89-09.02	
Hilux [Africa] 3.0 D 4x4	3,0	67	01.98→	
Hilux [N3/N4] 2.2 D	2,2	49	08.80-07.83	
				SBR,VO
2.2 D 4WD	2,2	49	08.81-07.83	
Hilux [N5/N6] 1.6	1,6	50	08.86-07.98	
1.8	1,8	65	08.87-08.88	
2.0	2,0	65	09.83-01.85	STB
			09.83-08.88	
			09.86-08.88	TBR
2.2	2,2	75	08.86-07.98	
Hilux [N10] 2.0 i 4x4	2,0	71	08.94-08.97	
Hilux [N16/N17] 2.0 i 4x4	2,0	81	08.97-08.99	
2.7 i 4WD	2,7	107	08.99-07.04	
Hilux [Raider] 3.0 D 4x4	3,0	85	01.98-12.02	
3.0 TD	3,0	85	07.00-02.02	
Hilux Pickup [N8] 1.8	1,8	57	01.89-10.94	
Hilux Pickup [N8/N9/N10/N11/N13] 1.8	1,8	57	08.88-08.94	
2.2 4WD	2,2	69	08.88-08.94	
2.4 D	2,4	62	08.88-07.97	
			08.88-08.97	
			09.94-08.97	
2.4 D 4x4	2,4	62	09.88-08.97	
			08.91-08.97	
2.4 i 4WD	2,4	84	08.89-08.97	
2.4 i 4x4	2,4	84	08.88-08.97	



					S				S		
							0986 487 743	270 X 57			
							0986 487 744	254 X 51			
							0986 487 414	295 X 50	1 987 475 244		
							0986 487 414	295 X 50			
							0986 487 414	295 X 50	1 987 475 244		
							0986 487 414	295 X 50	1 987 475 244		
							0986 487 414	295 X 50	1 987 475 244		
							0986 487 744	254 X 51			
							0986 487 414	295 X 50			
							0986 487 414	295 X 50	1 987 475 244		
							0986 487 744	254 X 51			
							0986 487 414	295 X 50			
							0986 487 414	295 X 50	1 987 475 244		
							0986 487 414	295 X 50	1 987 475 244		
							0986 487 414	295 X 50	1 987 475 244		
							0986 487 294	228,5 X 41			
							0986 487 294	228,5 X 41			
							0986 487 294	228,5 X 41			
							0986 487 294	228,5 X 41			
15,2											0 986 487 727
15,2											0 986 487 727
							0986 487 588	228,5 X 42	1 987 475 117		
							0986 487 332	255 X 46			
							0986 487 376	254 X 50			
							0986 487 376	254 X 50			
							0986 487 376	254 X 50			
							0986 487 376	254 X 50			
							0986 487 376	254 X 50			
							0986 487 376	254 X 50			
							0986 487 662	294 X 47			
							0986 487 376	254 X 50			
							0986 487 662	294 X 47			
							0986 487 376	254 X 50			
							0986 477 022	230 X 58,5	0986 487 201	230 X 50	1 987 475 046
							0986 477 022	230 X 58,5	0986 487 201	230 X 50	1 987 475 046
							0986 477 022	230 X 58,5	0986 487 201	230 X 50	1 987 475 046
							0986 477 022	230 X 58,5	0986 487 201	230 X 50	1 987 475 046
							0986 477 022	230 X 58,5	0986 487 201	230 X 50	1 987 475 098
							0986 477 022	230 X 58,5	0986 487 201	230 X 50	1 987 475 046
15,0							0986 487 658	230 X 42			0 204 114 633
							0986 477 100	230 X 49,5			





◀ VAUXHALL

Combo [Tour] 1.3 CDTi	1,3	55	03.06→				GIR	0 986 424 646	23 417
				ABO					
				26D	0 986 479 191	264 / 10			
				336	0 986 478 731	240 / 10			
1.4 i Twinport	1,4	66	01.04→				GIR	0 986 424 646	23 417
				26D	0 986 479 191	264 / 10			
				336	0 986 478 731	240 / 10			
			Fg.no. 42000001→ 45000001→ 46000001→ 48000001→	01.04→	ABO				
1.4 i Twinport Dualfuel	1,4	65	09.04→				GIR	0 986 424 646	23 417
				26D	0 986 479 191	264 / 10			
				336	0 986 478 731	240 / 10			
			Fg.no. 42000001→ 45000001→ 46000001→ 48000001→	09.04→	ABO				
1.6 CNG	1,6	69	06.06→				GIR	0 986 424 646	23 417
				ABO					
				26D	0 986 479 191	264 / 10			
				336	0 986 478 731	240 / 10			
		69-71	04.05→				GIR	0 986 424 646	23 417
				ABO					
				26D	0 986 479 191	264 / 10			
				336	0 986 478 731	240 / 10			
1.6 i	1,6	64	10.01-08.04				GIR	0 986 424 528	23 284
				ABO					
				26D	0 986 479 191	264 / 10			
				336	0 986 478 731	240 / 10			
1.7 CDTi	1,7	74	09.04→				GIR	0 986 424 646	23 417
				26D	0 986 479 191	264 / 10			
				336	0 986 478 731	240 / 10			
			Fg.no. 42000001→ 45000001→ 46000001→ 48000001→	09.04→	ABO				
1.7 DI	1,7	48	09.01-08.04				GIR	0 986 424 528	23 284
				ABO					
				26D	0 986 479 191	264 / 10			
				336	0 986 478 731	240 / 10			
1.7 DTI	1,7	55	10.01-08.04				GIR	0 986 424 528	23 284
				ABO					
				26D	0 986 479 191	264 / 10			
				336	0 986 478 731	240 / 10			
Euromidi 2.0	2,0	74	09.88-08.96	MC2,SAL					
2.0 DT	2,0	51	09.88-08.96	MC2,SAL					
2.2 D	2,2	45	09.88-08.96	MC2,SAL					
2.4 DT	2,4	56	09.88-08.96	MC2,SAL					
Movano 1.9 D	1,9	59	01.99-10.01		0 986 478 970	305 / 12		0 986 494 043	23 669
1.9 DTI	1,9	60	10.01-10.05		0 986 478 970	305 / 12		0 986 494 043	23 669
2.2 DTI	2,2	66	01.01-10.05		0 986 478 970	305 / 12		0 986 494 043	23 669
2.5 D	2,5	59	10.98-10.05		0 986 478 970	305 / 12		0 986 494 043	23 669
2.5 DTI	2,5	74-84	04.04→		0 986 478 970	305 / 12		0 986 494 043	23 669
		74-88	08.06→		0 986 478 970	305 / 12		0 986 494 043	23 669
		84	10.01-03.07		0 986 478 970	305 / 12		0 986 494 043	23 669
		107	08.06→		0 986 478 970	305 / 12		0 986 494 043	23 669
2.8 DTI	2,8	84	06.98-10.01		0 986 478 970	305 / 12		0 986 494 043	23 669
			10.98-10.05		0 986 478 970	305 / 12		0 986 494 043	23 669
3.0 DTI	3,0	100	10.03-10.05		0 986 478 970	305 / 12		0 986 494 043	23 669
Vivaro 1.9 DI	1,9	59-60	03.01-08.06	BSM	0 986 479 271	280 / 12			
				WW,XXX				0 986 494 040	23 980
			Fg.no. →6V699999 →6Y999999	03.01-08.06				0 986 494 040	23 980





◀ VAUXHALL

Vivaro 1.9 DTI	1,9	74	03.01-08.06	BSM WW,XXX	0 986 479 271	280 / 12		0 986 494 040	23 980
			Fg.no. →6V699999 →6Y999999	03.01-08.06				0 986 494 040	23 980
2.0 CDTI	2,0	66	08.06→	WW,XXX	0 986 479 144	280 / 12		0 986 494 040	23 980
			Fg.no. →6V699999 →6Y999999	08.06→				0 986 494 040	23 980
		84	08.06→	WW,XXX	0 986 479 144	280 / 12		0 986 494 040	23 980
			Fg.no. →6V699999 →6Y999999	08.06→				0 986 494 040	23 980
2.0 16V	2,0	86-88	03.01→	BSM WW,XXX	0 986 479 271	280 / 12		0 986 494 040	23 980
			Fg.no. →6V699999 →6Y999999	03.01→				0 986 494 040	23 980
2.5 CDTI	2,5	84	09.06-06.08	BSM WW,XXX	0 986 479 271	280 / 12		0 986 494 040	23 980
			Fg.no. →6V699999 →6Y999999	09.06-06.08				0 986 494 040	23 980
		107	08.06→	WW,XXX	0 986 479 144	280 / 12		0 986 494 040	23 980
			Fg.no. →6V699999 →6Y999999	08.06→				0 986 494 040	23 980
2.5 DTI	2,5	99	04.04-08.06	WW,XXX	0 986 479 144	280 / 12		0 986 494 040	23 980
			Fg.no. →6V699999 →6Y999999	04.04-08.06				0 986 494 040	23 980

VW (VOLKSWAGEN)

Bus [24, 25] 1.6 D	1,6	37	08.84-07.87	NOR VEA					
1.6 D Turbo	1,6	51	08.84-07.92	NOR VEA					
1.6 D Turbo Syncro	1,6	51	03.86-07.92	14Z,NOR 14Z,VEA 16Z					
1.7 D	1,7	42	10.86-07.92	NOR VEA					
1.9	1,9	40	08.84-05.88	NOR VEA					
		44	08.82-07.92	NOR VEA					
		54	08.86-10.88	NOR VEA					
		57	09.82-07.92	NOR VEA					
		60	08.83-07.85	NOR VEA					
		66	08.83-08.85	NOR VEA					





◀ VW

Bus [24, 25]	1.9 Syncro	1,9	54		10.86-10.88	14Z,NOR 14Z,VEA 16Z					
	2.1	2,1	64		08.86-07.92	NOR VEA					
			68		08.89-07.92	NOR VEA					
			70		08.85-07.92	NOR VEA					
			82		08.85-07.92	NOR VEA					
	2.1 Syncro	2,1	64		10.86-07.92	14Z,NOR 14Z,VEA 16Z					
			70		08.85-07.92	14Z,NOR 14Z,VEA 16Z					
			82		01.86-07.92	14Z,NOR 14Z,VEA 16Z					
Caddy [2K]	1.4	1,4	55		02.04-05.06		0986 479 155	260/12	GIR	0986 494 053	23914
			59	Fg.no. →2K..8..060 000	05.06-10.07		0986 479 155	260/12	GIR	0986 494 053	23914
				Fg.no. 2K..8..060 001→	11.07-05.08		0986 479 099	255/10	GIR	0986 461 769	20961
	1.6	1,6	75		04.04-05.05		0986 479 155	260/12	GIR	0986 494 053	23914
				Fg.no. →2K..8..060 000	06.05-10.07		0986 479 155	260/12	GIR	0986 494 053	23914
				Fg.no. 2K..8..060 001→	11.07-05.08		0986 479 099	255/10	GIR	0986 461 769	20961
	1.9 TDI	1,9	55		09.05-10.07		0986 479 155	260/12	GIR	0986 494 053	23914
				Fg.no. →2K..8..060 000	09.05-10.07		0986 479 155	260/12	GIR	0986 494 053	23914
				Fg.no. 2K..8..060 001→	11.07-05.08		0986 479 099	255/10	GIR	0986 461 769	20961
			77		02.04-10.07		0986 479 155	260/12	GIR	0986 494 053	23914
				Fg.no. →2K..8..060 000	02.04-10.07		0986 479 155	260/12	GIR	0986 494 053	23914
				Fg.no. 2K..8..060 001→	11.07-05.08		0986 479 099	255/10	GIR	0986 461 769	20961
	2.0 Eco Fuel	2,0	80		04.06-05.08		0986 479 155	260/12	GIR	0986 494 053	23914
	2.0 SDI	2,0	51		02.04-10.07		0986 479 155	260/12	GIR	0986 494 053	23914
				Fg.no. →2K..8..060 000	02.04-10.07		0986 479 155	260/12	GIR	0986 494 053	23914
				Fg.no. 2K..8..060 001→	11.07-05.08		0986 479 099	255/10	GIR	0986 461 769	20961
	2.0 TDI	2,0	103		09.07-05.08		0986 479 155	260/12	GIR	0986 494 053	23914
					09.07-05.08		0986 479 155	260/12	GIR	0986 494 053	23914
Caddy [9K9]	1.4	1,4	44		11.95-12.97 11.97-06.03						
					09.00-06.03						
				Fg.no. →9K..Y..500 747	11.97-05.99						
				Fg.no. 9K..Y..500 748→	06.99-06.03						
			55		09.00-06.03						
	1.6	1,6	55		11.95-05.97 06.97-09.00						
					06.97-05.99						
				Fg.no. →9K..Y..500 747	06.97-05.99						
				Fg.no. 9K..Y..500 748→	06.99-09.00						
	1.7 SDI	1,7	42		07.96-09.00						
					07.96-05.99						
				Fg.no. →9K..Y..500 747	07.96-05.99						
				Fg.no. 9K..Y..500 748→	06.99-09.00						
	1.9 D	1,9	47		11.95-06.03						
					11.95-05.99						
				Fg.no. →9K..Y..500 747	11.95-05.99						
				Fg.no. 9K..Y..500 748→	06.99-06.03						
	1.9 SDI	1,9	47		11.95-09.00						
					09.00-06.03						
					11.95-05.99						
				Fg.no. →9K..Y..500 747	11.95-05.99						
				Fg.no. 9K..Y..500 748→	06.99-09.00						





◀ VW

Caddy [9K9] 1.9 TDI	1,9	66	10.96-03.97 12.96-09.00						
			09.00-06.03						
			Fg.no. →9K..Y..500 747						
			Fg.no. 9K..Y..500 748→						
Caddy Pickup [9U7] 1.6	1,6	55	06.96-12.00						
1.9 D	1,9	47	06.96-12.00						
Caddy Pickup [14, 1A] 1.5	1,5	51	08.82-07.83						
			TR5						
			Fg.no. →14-H-011 048						
1.6	1,6	55	08.82-07.83						
			TR5						
			08.83-07.92						
			TR5						
			Fg.no. →14-H-011 048						
1.6 D	1,6	40	08.82-07.90						
			TR5						
			08.90-07.92						
			TR5						
1.8	1,8	70	08.85-07.92						
			TR5						
California T4 [70, 7D] 1.8	1,8	49	12.90-07.92						
			280	0986 478 871	280 / 12	GIR	0986 494 051	23 224	
			280,WW, XXX			GIR	0986 424 748	23 224	
			294	0986 478 569	294 / 13,5	GIR	0986 494 025	23 446	
			294,WW, XXX			GIR	0986 424 542	23 446	
1.9 D	1,9	45	09.90-04.97						
			280	0986 478 871	280 / 12	GIR	0986 494 051	23 224	
			280,WW, XXX			GIR	0986 424 748	23 224	
			294	0986 478 569	294 / 13,5	GIR	0986 494 025	23 446	
			294,WW, XXX			GIR	0986 424 542	23 446	
1.9 D Turbo	1,9	50	10.92-06.03						
			280	0986 478 871	280 / 12	GIR	0986 494 051	23 224	
			280,WW, XXX			GIR	0986 424 748	23 224	
			294	0986 478 569	294 / 13,5	GIR	0986 494 025	23 446	
			294,WW, XXX			GIR	0986 424 542	23 446	
2.0	2,0	62	09.90-06.03						
			280	0986 478 871	280 / 12	GIR	0986 494 051	23 224	
			280,WW, XXX			GIR	0986 424 748	23 224	
			294	0986 478 569	294 / 13,5	GIR	0986 494 025	23 446	
			294,WW, XXX			GIR	0986 424 542	23 446	
2.4 D	2,4	55	05.97-06.03						
			280	0986 478 871	280 / 12	GIR	0986 494 051	23 224	
			280,WW, XXX			GIR	0986 424 748	23 224	
			294	0986 478 569	294 / 13,5	GIR	0986 494 025	23 446	
			294,WW, XXX			GIR	0986 424 542	23 446	



							0986 487 281	230 X 40	1987 475 242			0 204 114 634
												0 204 114 634
												0 204 114 635
							0986 487 555	230 X 32	1987 475 204			0 204 114 635
							0986 487 281	230 X 40	1987 475 242			
							0986 487 555	230 X 32	1987 475 204			
				0986 477 041	200 X 49,5		0986 487 270	200 X 40	1987 475 110			
				0986 477 041	200 X 49,5		0986 487 270	200 X 40	1987 475 110			
				0986 477 011	230 X 51,3							
										ATE		0 204 114 053
							0986 487 281	230 X 40	1987 475 012			
				0986 477 011	230 X 51,3					ATE		0 204 114 053
				0986 477 011	230 X 51,3		0986 487 281	230 X 40	1987 475 012			
				0986 477 011	230 X 51,3		0986 487 281	230 X 40	1987 475 012			
										ATE		0 204 114 053
				0986 477 011	230 X 51,3		0986 487 281	230 X 40				
										ATE		0 204 114 053
				0986 477 011	230 X 51,3		0986 487 281	230 X 40	1987 475 012			
										ATE		0 204 114 053
				0986 477 046	268 X 67,5		0986 487 312	270 X 55	1987 475 133			
17,3												
16,5	1987 474 264											
16,5												
				0986 477 046	268 X 67,5		0986 487 312	270 X 55	1987 475 133			
17,3												
16,5	1987 474 264											
16,5												
				0986 477 046	268 X 67,5		0986 487 312	270 X 55	1987 475 133			
17,3												
16,5	1987 474 264											
16,5												
				0986 477 046	268 X 67,5		0986 487 312	270 X 55	1987 475 133			
17,3												
16,5	1987 474 264											
16,5												
				0986 477 046	268 X 67,5		0986 487 312	270 X 55	1987 475 133			
17,3												
16,5	1987 474 264											
16,5												











◀ VW

California T4 [70, 7D] 2.4D	2,4	57	09.90-05.98	280	0986 478 871	280 / 12	GIR	0986 494 051	23 224
				280,WW,XXX			GIR	0986 424 748	23 224
				294	0986 478 569	294 / 13,5	GIR	0986 494 025	23 446
				294,WW,XXX			GIR	0986 424 542	23 446
				2.4 D Syncro	2,4	57	11.92-09.98	280	0986 478 871
				280,WW,XXX			GIR	0986 424 748	23 224
				294	0986 478 569	294 / 13,5	GIR	0986 494 025	23 446
				294,WW,XXX			GIR	0986 424 542	23 446
2.5	2,5	81	11.90-06.03	280	0986 478 871	280 / 12	GIR	0986 494 051	23 224
				280,WW,XXX			GIR	0986 424 748	23 224
				294	0986 478 569	294 / 13,5	GIR	0986 494 025	23 446
				294,WW,XXX			GIR	0986 424 542	23 446
				85		08.96-06.03	280	0986 478 871	280 / 12
				280,WW,XXX			GIR	0986 424 748	23 224
				294	0986 478 569	294 / 13,5	GIR	0986 494 025	23 446
				294,WW,XXX			GIR	0986 424 542	23 446
2.5 Syncro	2,5	81	11.92-10.96	280	0986 478 871	280 / 12	GIR	0986 494 051	23 224
				280,WW,XXX			GIR	0986 424 748	23 224
				294	0986 478 569	294 / 13,5	GIR	0986 494 025	23 446
				294,WW,XXX			GIR	0986 424 542	23 446
				06.97-11.01			280	0986 478 871	280 / 12
				280,WW,XXX			GIR	0986 424 748	23 224
				294	0986 478 569	294 / 13,5	GIR	0986 494 025	23 446
				294,WW,XXX			GIR	0986 424 542	23 446
85			08.96-06.03	280	0986 478 871	280 / 12	GIR	0986 494 051	23 224
				280,WW,XXX			GIR	0986 424 748	23 224
				294	0986 478 569	294 / 13,5	GIR	0986 494 025	23 446
				294,WW,XXX			GIR	0986 424 542	23 446
				2.5 TDI	2,5	65	05.98-06.03	280	0986 478 871
				280,WW,XXX			GIR	0986 424 748	23 224
				294	0986 478 569	294 / 13,5	GIR	0986 494 025	23 446
				294,WW,XXX			GIR	0986 424 542	23 446
75			01.95-06.03	280	0986 478 871	280 / 12	GIR	0986 494 051	23 224
				280,WW,XXX			GIR	0986 424 748	23 224
				294	0986 478 569	294 / 13,5	GIR	0986 494 025	23 446
				294,WW,XXX			GIR	0986 424 542	23 446



												
17,3				0 986 477 046 268X67,5				0 986 487 312 270X55			1 987 475 133	
16,5	1 987 474 264											
16,5												
17,3				0 986 477 046 268X67,5				0 986 487 312 270X55			1 987 475 133	
16,5	1 987 474 264											
16,5												
17,3				0 986 477 046 268X67,5				0 986 487 312 270X55			1 987 475 133	
16,5	1 987 474 264											
16,5												
17,3				0 986 477 046 268X67,5				0 986 487 312 270X55			1 987 475 133	
16,5	1 987 474 264											
16,5												
17,3				0 986 477 046 268X67,5				0 986 487 312 270X55			1 987 475 133	
16,5	1 987 474 264											
16,5												
17,3				0 986 477 046 268X67,5				0 986 487 312 270X55			1 987 475 133	
16,5	1 987 474 264											
16,5												
17,3				0 986 477 046 268X67,5				0 986 487 312 270X55			1 987 475 133	
16,5	1 987 474 264											
16,5												
17,3				0 986 477 046 268X67,5				0 986 487 312 270X55			1 987 475 133	
16,5	1 987 474 264											
16,5												





◀ VW

California T4 [70, 7D] 2.5 TDI				2,5	111	05.98-06.03					
						280	0986 478 871	280 / 12	GIR	0986 494 051	23 224
						280,WW,XXX			GIR	0986 424 748	23 224
						294	0986 478 569	294 / 13,5	GIR	0986 494 025	23 446
						294,WW,XXX			GIR	0986 424 542	23 446
2.5 TDI Syncro				2,5	75	03.98-06.03					
						280	0986 478 871	280 / 12	GIR	0986 494 051	23 224
						280,WW,XXX			GIR	0986 424 748	23 224
						294	0986 478 569	294 / 13,5	GIR	0986 494 025	23 446
						294,WW,XXX			GIR	0986 424 542	23 446
			PR no. 2E3			1KX			GIR	0986 494 025	23 446
2.8				2,8	103	05.96-05.00					
						280	0986 478 871	280 / 12	GIR	0986 494 051	23 224
						280,WW,XXX			GIR	0986 424 748	23 224
						294	0986 478 569	294 / 13,5	GIR	0986 494 025	23 446
						294,WW,XXX			GIR	0986 424 542	23 446
				150		05.00-06.03					
						280	0986 478 871	280 / 12	GIR	0986 494 051	23 224
						280,WW,XXX			GIR	0986 424 748	23 224
						294	0986 478 569	294 / 13,5	GIR	0986 494 025	23 446
						294,WW,XXX			GIR	0986 424 542	23 446
California T5 [7H] 1.9 TDI				1,9	62	01.06→					
						294,BVA,MVB				0986 494 108	23882
						294,INB	0986 479 097	294 / 21,9			
						322,INB	0986 479 094	314 / 22			
				63		04.03→					
						294,BVA,MVB				0986 494 108	23882
						294,INB	0986 479 097	294 / 21,9			
						322,INB	0986 479 094	314 / 22			
				75		01.06→					
						294,BVA,MVB				0986 494 108	23882
						294,INB	0986 479 097	294 / 21,9			
						322,INB	0986 479 094	314 / 22			
				77		04.03→					
						294,BVA,MVB				0986 494 108	23882
						294,INB	0986 479 097	294 / 21,9			
						322,INB	0986 479 094	314 / 22			
2.0				2,0	85	06.03→					
						294,BVA,MVB				0986 494 108	23882
						294,INB	0986 479 097	294 / 21,9			
						322,INB	0986 479 094	314 / 22			
2.5 TDI				2,5	96	02.03→					
						294,BVA,MVB				0986 494 108	23882
						294,INB	0986 479 097	294 / 21,9			
						322,INB	0986 479 094	314 / 22			



						S				S		
				0 986 477 046	268X67,5		0 986 487 312	270X55	1 987 475 133			
17,3												
16,5	1 987 474 264											
16,5												
				0 986 477 046	268X67,5		0 986 487 312	270X55	1 987 475 133			
17,3												
16,5	1 987 474 264											
16,5												
16,5				0 986 477 046	268X67,5		0 986 487 312	270X55	1 987 475 133			
17,3												
16,5	1 987 474 264											
16,5												
				0 986 477 046	268X67,5		0 986 487 312	270X55	1 987 475 133			
17,3												
16,5	1 987 474 264											
16,5												
												0 986 487 625
17,5												
												0 986 487 625
17,5												
												0 986 487 625
17,5												
												0 986 487 625
17,5												
												0 986 487 625
17,5												
												0 986 487 625
17,5												





◀ VW											
California T5 [7H] 2.5 TDI	2,5	120	11.03→	294,BVA, MVB						0986 494 108	23882
				294,INB	0986 479 097	294 / 21,9					
				322,INB	0986 479 094	314 / 22					
		128	02.03→	294,BVA, MVB						0986 494 108	23882
				294,INB	0986 479 097	294 / 21,9					
				322,INB	0986 479 094	314 / 22					
2.5 TDI 4 Motion	2,5	96	07.04→	294,BVA						0986 494 108	23882
				294,INB	0986 479 097	294 / 21,9					
				322,INB	0986 479 094	314 / 22					
		128	07.04→	294,BVA						0986 494 108	23882
				294,INB	0986 479 097	294 / 21,9					
				322,INB	0986 479 094	314 / 22					
3.2	3,2	170	02.03-06.04	294,BVA, MVB						0986 494 108	23882
				294,INB	0986 479 097	294 / 21,9					
				322,INB	0986 479 094	314 / 22					
		173	05.03→	294,BVA, MVB						0986 494 108	23882
				294,INB	0986 479 097	294 / 21,9					
				322,INB	0986 479 094	314 / 22					
3.2 4 Motion	3,2	173	07.04→	294,BVA						0986 494 108	23882
				294,INB	0986 479 097	294 / 21,9					
				322,INB	0986 479 094	314 / 22					
Caravelle T4 [70, 7D] 1.8	1,8	49	12.90-07.92	280	0986 478 871	280 / 12	GIR	0986 494 051	23 224		
				280,WW, XXX			GIR	0986 424 748	23 224		
				294	0986 478 569	294 / 13,5	GIR	0986 494 025	23 446		
				294,WW, XXX			GIR	0986 424 542	23 446		
1.9 D	1,9	45	10.90-04.97	280	0986 478 871	280 / 12	GIR	0986 494 051	23 224		
				280,WW, XXX			GIR	0986 424 748	23 224		
				294	0986 478 569	294 / 13,5	GIR	0986 494 025	23 446		
				294,WW, XXX			GIR	0986 424 542	23 446		
1.9 D Turbo	1,9	50	10.92-06.03	280	0986 478 871	280 / 12	GIR	0986 494 051	23 224		
				280,WW, XXX			GIR	0986 424 748	23 224		
				294	0986 478 569	294 / 13,5	GIR	0986 494 025	23 446		
				294,WW, XXX			GIR	0986 424 542	23 446		
2.0	2,0	62	09.90-06.03	280	0986 478 871	280 / 12	GIR	0986 494 051	23 224		
				280,WW, XXX			GIR	0986 424 748	23 224		
				294	0986 478 569	294 / 13,5	GIR	0986 494 025	23 446		
				294,WW, XXX			GIR	0986 424 542	23 446		







◀ VW

Caravelle T4 [70, 7D] 2.4 D	2,4	55	05.97-06.03						
				280	0986 478 871	280 / 12	GIR	0986 494 051	23 224
				280,WW,XXX			GIR	0986 424 748	23 224
				294	0986 478 569	294 / 13,5	GIR	0986 494 025	23 446
				294,WW,XXX			GIR	0986 424 542	23 446
		57	09.90-05.98						
				280	0986 478 871	280 / 12	GIR	0986 494 051	23 224
				280,WW,XXX			GIR	0986 424 748	23 224
				294	0986 478 569	294 / 13,5	GIR	0986 494 025	23 446
				294,WW,XXX			GIR	0986 424 542	23 446
2.4 D Syncro	2,4	57	11.92-09.98						
				280	0986 478 871	280 / 12	GIR	0986 494 051	23 224
				280,WW,XXX			GIR	0986 424 748	23 224
				294	0986 478 569	294 / 13,5	GIR	0986 494 025	23 446
				294,WW,XXX			GIR	0986 424 542	23 446
2.5	2,5	81	11.90-12.93						
				280	0986 478 871	280 / 12	GIR	0986 494 051	23 224
				280,WW,XXX			GIR	0986 424 748	23 224
				294	0986 478 569	294 / 13,5	GIR	0986 494 025	23 446
				294,WW,XXX			GIR	0986 424 542	23 446
			07.94-06.03						
				280	0986 478 871	280 / 12	GIR	0986 494 051	23 224
				280,WW,XXX			GIR	0986 424 748	23 224
				294	0986 478 569	294 / 13,5	GIR	0986 494 025	23 446
				294,WW,XXX			GIR	0986 424 542	23 446
		85	08.96-06.03						
				280	0986 478 871	280 / 12	GIR	0986 494 051	23 224
				280,WW,XXX			GIR	0986 424 748	23 224
				294	0986 478 569	294 / 13,5	GIR	0986 494 025	23 446
				294,WW,XXX			GIR	0986 424 542	23 446
2.5 Syncro	2,5	81	11.92-10.96						
				280	0986 478 871	280 / 12	GIR	0986 494 051	23 224
				280,WW,XXX			GIR	0986 424 748	23 224
				294	0986 478 569	294 / 13,5	GIR	0986 494 025	23 446
				294,WW,XXX			GIR	0986 424 542	23 446
			06.97-11.01						
				280	0986 478 871	280 / 12	GIR	0986 494 051	23 224
				280,WW,XXX			GIR	0986 424 748	23 224
				294	0986 478 569	294 / 13,5	GIR	0986 494 025	23 446
				294,WW,XXX			GIR	0986 424 542	23 446
		85	08.96-06.03						
				280	0986 478 871	280 / 12	GIR	0986 494 051	23 224
				280,WW,XXX			GIR	0986 424 748	23 224
				294	0986 478 569	294 / 13,5	GIR	0986 494 025	23 446
				294,WW,XXX			GIR	0986 424 542	23 446











											
17,3				0 986 477 046 268X67,5				0 986 487 312 270X55			1 987 475 133
16,5	1 987 474 264										
16,5											
17,3				0 986 477 046 268X67,5				0 986 487 312 270X55			1 987 475 133
16,5	1 987 474 264										
16,5											
17,3				0 986 477 046 268X67,5				0 986 487 312 270X55			1 987 475 133
16,5	1 987 474 264										
16,5											
17,3				0 986 477 046 268X67,5				0 986 487 312 270X55			1 987 475 133
16,5	1 987 474 264										
16,5											
17,3				0 986 477 046 268X67,5				0 986 487 312 270X55			1 987 475 133
16,5	1 987 474 264										
16,5											
17,3				0 986 477 046 268X67,5				0 986 487 312 270X55			1 987 475 133
16,5	1 987 474 264										
16,5											
17,3				0 986 477 046 268X67,5				0 986 487 312 270X55			1 987 475 133
16,5	1 987 474 264										
16,5											
17,3				0 986 477 046 268X67,5				0 986 487 312 270X55			1 987 475 133
16,5	1 987 474 264										
16,5											





◀ VW											
Caravelle T4 [70, 7D]	2,5	65	05.98-06.03	280	0986 478 871	280 / 12	GIR	0986 494 051	23 224		
				280,WW,XXX			GIR	0986 424 748	23 224		
				294	0986 478 569	294 / 13,5	GIR	0986 494 025	23 446		
				294,WW,XXX			GIR	0986 424 542	23 446		
	75	01.95-06.03	280	0986 478 871	280 / 12	GIR	0986 494 051	23 224			
			280,WW,XXX			GIR	0986 424 748	23 224			
			294	0986 478 569	294 / 13,5	GIR	0986 494 025	23 446			
			294,WW,XXX			GIR	0986 424 542	23 446			
	111	05.98-06.03	280	0986 478 871	280 / 12	GIR	0986 494 051	23 224			
			280,WW,XXX			GIR	0986 424 748	23 224			
			294	0986 478 569	294 / 13,5	GIR	0986 494 025	23 446			
			294,WW,XXX			GIR	0986 424 542	23 446			
2.5 TDI Syncro	2,5	75	03.98-06.03	280	0986 478 871	280 / 12	GIR	0986 494 051	23 224		
				280,WW,XXX			GIR	0986 424 748	23 224		
				294	0986 478 569	294 / 13,5	GIR	0986 494 025	23 446		
				294,WW,XXX			GIR	0986 424 542	23 446		
2.8	2,8	103	PR no. 2E3 04.01-06.03	1KX			GIR	0986 494 025	23 446		
				01.96-05.00	280	0986 478 871	280 / 12	GIR	0986 494 051	23 224	
					280,WW,XXX			GIR	0986 424 748	23 224	
					294	0986 478 569	294 / 13,5	GIR	0986 494 025	23 446	
	294,WW,XXX				GIR	0986 424 542	23 446				
	150	05.00-06.03	280	0986 478 871	280 / 12	GIR	0986 494 051	23 224			
			280,WW,XXX			GIR	0986 424 748	23 224			
			294	0986 478 569	294 / 13,5	GIR	0986 494 025	23 446			
			294,WW,XXX			GIR	0986 424 542	23 446			
	Caravelle T5 [7H] 1.9 TDI	1,9	62	01.06→	294,BVA,MVB				0986 494 108	23882	
					294,INB	0986 479 097	294 / 21,9				
					322,INB	0986 479 094	314 / 22				
63					04.03→	294,BVA,MVB				0986 494 108	23882
		294,INB	0986 479 097	294 / 21,9							
		322,INB	0986 479 094	314 / 22							
		75	01.06→	294,BVA,MVB					0986 494 108	23882	
294,INB				0986 479 097	294 / 21,9						
322,INB				0986 479 094	314 / 22						
77				04.03→	294,BVA,MVB				0986 494 108	23882	
		294,INB	0986 479 097		294 / 21,9						
		322,INB	0986 479 094		314 / 22						



						S				S		
17,3				0 986 477 046	268X67,5		0 986 487 312	270X55	1 987 475 133			
16,5	1 987 474 264											
16,5												
17,3				0 986 477 046	268X67,5		0 986 487 312	270X55	1 987 475 133			
16,5	1 987 474 264											
16,5												
17,3				0 986 477 046	268X67,5		0 986 487 312	270X55	1 987 475 133			
16,5	1 987 474 264											
16,5												
17,3				0 986 477 046	268X67,5		0 986 487 312	270X55	1 987 475 133			
16,5	1 987 474 264											
16,5												
17,3				0 986 477 046	268X67,5		0 986 487 312	270X55	1 987 475 133			
16,5	1 987 474 264											
16,5												
17,3				0 986 477 046	268X67,5		0 986 487 312	270X55	1 987 475 133			
16,5	1 987 474 264											
16,5												
17,5												0 986 487 625
17,5												0 986 487 625
17,5												0 986 487 625
17,5												0 986 487 625





◀ VW												
Caravelle T5 [7H] 2.0	2,0	85	06.03→	294,BVA, MVB				0 986 494 108	23882			
				294,INB	0 986 479 097	294 / 21,9						
				322,INB	0 986 479 094	314 / 22						
2.5 TDI	2,5	96	02.03→	294,BVA, MVB				0 986 494 108	23882			
				294,INB	0 986 479 097	294 / 21,9						
				322,INB	0 986 479 094	314 / 22						
120			11.03→	294,BVA, MVB				0 986 494 108	23882			
				294,INB	0 986 479 097	294 / 21,9						
				322,INB	0 986 479 094	314 / 22						
128			02.03→	294,BVA, MVB				0 986 494 108	23882			
				294,INB	0 986 479 097	294 / 21,9						
				322,INB	0 986 479 094	314 / 22						
2.5 TDI 4 Motion	2,5	96	07.04→	294,BVA				0 986 494 108	23882			
				294,INB	0 986 479 097	294 / 21,9						
				322,INB	0 986 479 094	314 / 22						
128			07.04→	294,BVA				0 986 494 108	23882			
				294,INB	0 986 479 097	294 / 21,9						
				322,INB	0 986 479 094	314 / 22						
3.2	3,2	170	02.03-06.04	294,BVA, MVB				0 986 494 108	23882			
				294,INB	0 986 479 097	294 / 21,9						
				322,INB	0 986 479 094	314 / 22						
173			05.03→	294,BVA, MVB				0 986 494 108	23882			
				294,INB	0 986 479 097	294 / 21,9						
				322,INB	0 986 479 094	314 / 22						
3.2 4 Motion	3,2	173	07.04→	294,BVA				0 986 494 108	23882			
				294,INB	0 986 479 097	294 / 21,9						
				322,INB	0 986 479 094	314 / 22						
Crafter 30 [2E] 2.5 TDI	2,5	65	04.06→	MTS				0 986 494 123	29190			
				80				0 986 479 295	298 / 16	BSY	0 986 494 123	29190
				100				0 986 479 295	298 / 16	BSY	0 986 494 123	29190
				120				0 986 479 295	298 / 16	BSY	0 986 494 123	29190
				MTS				0 986 479 295	298 / 16	BSY	0 986 494 123	29190
Crafter 35 [2E] 2.5 TDI	2,5	65	04.06→	MTS				0 986 494 123	29190			
				80				0 986 479 295	298 / 16	BSY	0 986 494 123	29190
				100				0 986 479 295	298 / 16	BSY	0 986 494 123	29190
				120				0 986 479 295	298 / 16	BSY	0 986 494 123	29190
				MTS				0 986 479 295	298 / 16	BSY	0 986 494 123	29190
Crafter 50 [2E] 2.5 TDI	2,5	80	04.06→					0 986 479 296	303 / 28	BSY	0 986 494 122	29217
		100	04.06→					0 986 479 296	303 / 28	BSY	0 986 494 122	29217
		120	04.06→					0 986 479 296	303 / 28	BSY	0 986 494 122	29217
Eurovan [70] 2.5	2,5	81	09.91-12.93									





◀ VW									
LT [2D, 2H] 28 2.3	2,3	105	05.96-11.01						
								ATE	0986 424 463 21 621
				MTS					
				ZE					
28 2.5 SDI	2,5	55	05.96-04.01		0986 478 863	258/12			
								ATE	0986 424 463 21 621
				MTS					
				ZE					
28 2.5 TDI	2,5	61	04.01-04.06		0986 478 863	258/12			
								ATE	0986 424 463 21 621
				MTS					
				ZE					
		66	05.99-04.01		0986 478 863	258/12			
								ATE	0986 424 463 21 621
				MTS					
				ZE					
		70	04.01-04.06		0986 478 863	258/12			
								ATE	0986 424 463 21 621
				MTS					
				ZE					
		75	05.96-05.99		0986 478 863	258/12			
								ATE	0986 424 463 21 621
				MTS					
				ZE					
		80	05.99-04.06		0986 478 863	258/12			
								ATE	0986 424 463 21 621
				MTS					
				ZE					
28 2.8 D Turbo	2,8	92	07.97-12.98		0986 478 863	258/12			
								ATE	0986 424 463 21 621
				MTS					
				ZE					
		96	01.99-01.02		0986 478 863	258/12			
								ATE	0986 424 463 21 621
				MTS					
				ZE					
28 2.8 TDI	2,8	116	02.02-04.06		0986 478 863	258/12			
								ATE	0986 424 463 21 621
				MTS					
				ZE					
35 2.3	2,3	105	05.96-11.01		0986 478 433	272/16			
								ATE	0986 424 219 21 592
				BO				BSY	0986 424 516 23 021
				MTS					
35 2.5 SDI	2,5	55	05.96-04.01		0986 478 433	272/16			
								ATE	0986 424 219 21 592
				BO				BSY	0986 424 516 23 021
				MTS					
35 2.5 TDI	2,5	61	04.01-04.06		0986 478 433	272/16			
								ATE	0986 424 219 21 592
				BO				BSY	0986 424 516 23 021
				MTS					
		66	05.99-04.01		0986 478 433	272/16			
								ATE	0986 424 219 21 592
				BO				BSY	0986 424 516 23 021
				MTS					
		70	04.01-04.06		0986 478 433	272/16			
								ATE	0986 424 219 21 592
				BO				BSY	0986 424 516 23 021
				MTS					



					S	()			S		
											1 987 475 263
17,0											0 986 487 610
		1 987 473 007									1 987 475 263
17,0											0 986 487 610
		1 987 473 007									1 987 475 263
17,0											0 986 487 610
		1 987 473 007									1 987 475 263
17,0											0 986 487 610
		1 987 473 007									1 987 475 263
17,0											0 986 487 610
		1 987 473 007									1 987 475 263
17,0											0 986 487 610
		1 987 473 007									1 987 475 263
17,0											0 986 487 610
		1 987 473 007									1 987 475 263
17,0											0 986 487 610
		1 987 473 007									1 987 475 263
17,0											0 986 487 610
		1 987 473 007									1 987 475 263
18,5											0 986 487 610
19,0											1 987 475 263
18,5											0 986 487 610
19,0											1 987 475 263
18,5											0 986 487 610
19,0											1 987 475 263
18,5											0 986 487 610
19,0											1 987 475 263
18,5											0 986 487 610
19,0											1 987 475 263
18,5											0 986 487 610
19,0											1 987 475 263





◀ VW

LT [2D, 2H] 35 2.5 TDI	2,5	75	05.96-05.99	0986 478 433	272 / 16	ATE	0986 424 219	21 592	
						BO	BSY	0986 424 516	23 021
						MTS			
80	05.99-04.06	0986 478 433	272 / 16	ATE	0986 424 219	21 592			
				BO	BSY	0986 424 516	23 021		
				MTS					
35 2.8 D Turbo	2,8	92	07.97-12.98	0986 478 433	272 / 16	ATE	0986 424 219	21 592	
						BO	BSY	0986 424 516	23 021
						MTS			
96	01.99-01.02	0986 478 433	272 / 16	ATE	0986 424 219	21 592			
				BO	BSY	0986 424 516	23 021		
				MTS					
35 2.8 TDI	2,8	116	02.02-04.06	0986 478 433	272 / 16	ATE	0986 424 219	21 592	
						BO	BSY	0986 424 516	23 021
						MTS			
46 2.3	2,3	105	05.96-11.01	0986 478 555	285 / 22	ATE	0986 424 832	29 153	
						INB			
						MTS			
46 2.5 SDI	2,5	55	05.96-04.01	0986 478 555	285 / 22	ATE	0986 424 832	29 153	
						INB			
						MTS			
46 2.5 TDI	2,5	61	04.01-04.06	0986 478 555	285 / 22	ATE	0986 424 832	29 153	
						INB			
						MTS			
66	05.99-04.01	0986 478 555	285 / 22	ATE	0986 424 832	29 153			
				INB					
				MTS					
70	04.01-04.06	0986 478 555	285 / 22	ATE	0986 424 832	29 153			
				INB					
				MTS					
75	05.96-05.99	0986 478 555	285 / 22	ATE	0986 424 832	29 153			
				INB					
				MTS					
80	05.99-04.06	0986 478 555	285 / 22	ATE	0986 424 832	29 153			
				INB					
				MTS					
46 2.8 D Turbo	2,8	92	07.97-12.98	0986 478 555	285 / 22	ATE	0986 424 832	29 153	
						INB			
						MTS			
ZE									



											1 987 475 263
20,0											0 986 487 611
		1 987 473 007									1 987 475 263
20,0											0 986 487 611
		1 987 473 007									0 986 487 611
						0 986 487 318	252 X 56			1 987 475 216	
						0 986 487 193	252 X 56			1 987 475 178	
		0 986 477 034	252 X 65			0 986 487 193	252 X 56			1 987 475 178	
		0 986 477 034	252 X 65			0 986 487 318	252 X 56				
						0 986 487 193	252 X 56			1 987 475 178	
		0 986 477 034	252 X 65			0 986 487 318	252 X 56				
		0 986 477 035	270 X 73			0 986 487 389	270 X 66				
						0 986 487 318	252 X 56				
		0 986 477 034	252 X 65			0 986 487 318	252 X 56			1 987 475 216	
						0 986 487 193	252 X 56			1 987 475 178	
		0 986 477 034	252 X 65			0 986 487 318	252 X 56				
		0 986 477 035	270 X 73			0 986 487 389	270 X 66				
						0 986 487 193	252 X 56			1 987 475 178	
		0 986 477 034	252 X 65			0 986 487 318	252 X 56				
						0 986 487 318	252 X 56			1 987 475 216	
						0 986 487 318	252 X 56			1 987 475 216	
						0 986 487 318	252 X 56			1 987 475 216	
		0 986 477 034	252 X 65			0 986 487 193	252 X 56			1 987 475 178	
						0 986 487 193	252 X 56			1 987 475 178	
		0 986 477 034	252 X 65			0 986 487 318	252 X 56				
						0 986 487 193	252 X 56			1 987 475 178	
		0 986 477 034	252 X 65			0 986 487 318	252 X 56				
		0 986 477 035	270 X 73			0 986 487 389	270 X 66				
						0 986 487 318	252 X 56			1 987 475 178	
		0 986 477 034	252 X 65			0 986 487 318	252 X 56				
						0 986 487 318	252 X 56			1 987 475 216	
						0 986 487 193	252 X 56			1 987 475 178	
		0 986 477 034	252 X 65			0 986 487 318	252 X 56				
						0 986 487 193	252 X 56			1 987 475 178	
		0 986 477 034	252 X 65			0 986 487 318	252 X 56				
		0 986 477 035	270 X 73			0 986 487 389	270 X 66				
						0 986 487 193	252 X 56			1 987 475 178	
		0 986 477 034	252 X 65			0 986 487 318	252 X 56				
						0 986 487 318	252 X 56			1 987 475 216	





◀ VW					
LT [28, 29, 21] 35 2.4	2,4	66		12.82-07.92	ABM
			Fg.no. →29-M-009 906	08.89-11.90	
		70		10.88-04.96	
					ABM
			Fg.no. →29-M-009 906	08.89-11.90	
35 2.4 D	2,4	51		08.89-07.92	ABM
				08.92-04.96	ZWB
			Fg.no. →29-M-009 906	08.89-11.90	
		55		12.82-07.92	ABM
					E76
			Fg.no. →29-M-009 906	08.89-11.90	
35 2.4 D Turbo	2,4	68		08.88-08.92	
			Fg.no. →29-M-009 906	08.88-11.90	ABM
				08.89-11.90	
		70		09.92-04.96	ZWB
		75		12.82-08.92	E76
			Fg.no. →29-M-009 906	08.89-11.90	
40 2.4	2,4	62		04.83-07.86	ABM
		66		12.82-07.92	ABM
			Fg.no. →29-M-009 906	12.82-11.90	ABM
				08.89-11.90	
		70		10.88-04.96	
					ABM
			Fg.no. →29-M-009 906	08.89-11.90	
40 2.4 D	2,4	51		08.89-07.92	ABM
				08.92-04.96	ZWB
			Fg.no. →29-M-009 906	08.89-11.90	
		55		12.82-07.92	ABM
					E76
			Fg.no. →29-M-009 906	12.82-11.90	ABM
				08.89-11.90	
40 2.4 D Turbo	2,4	68		08.88-08.92	
			Fg.no. →29-M-009 906	08.88-11.90	ABM
				08.89-11.90	
		70		09.92-04.96	ZWB
		75		12.82-08.92	ABM
					E66,WW
					E76
			Fg.no. →29-M-009 906	12.82-11.90	ABM
				08.89-11.90	
45 2.4	2,4	62		04.83-07.86	ABM
		66		12.82-07.92	ABM
			Fg.no. →29-M-009 906	08.89-11.90	
45 2.4 D	2,4	51		08.92-04.96	ZWB
		55		12.82-07.92	ABM
			Fg.no. →29-M-009 906	08.89-11.90	
45 2.4 D Turbo	2,4	70		09.92-04.96	ZWB
		75		12.82-08.92	ABM
					E76
			Fg.no. →29-M-009 906	08.89-11.90	
50 2.4	2,4	62		12.82-07.86	ABM
		66		12.82-07.92	ABM
			Fg.no. →29-M-009 906	08.89-11.90	
50 2.4 D	2,4	51		08.92-04.96	ZWB
		55		12.82-07.92	ABM
					E66,WW
					E76
			Fg.no. →29-M-009 906	08.89-11.90	
50 2.4 D Turbo	2,4	70		09.92-04.96	ZWB
		75		12.82-08.92	ABM
			Fg.no. →29-M-009 906	08.89-11.90	

















◀ VW

LT [28, 29, 21] 55 2.4	2,4	62		08.85-07.86	ABM					
		66		08.85-07.92	ABM					
			Fg.no. →29-M-009 906	08.89-11.90						
55 2.4 D	2,4	51		08.92-04.96	ZWB					
		55		08.85-07.92	ABM					
			Fg.no. →29-M-009 906	08.89-11.90						
55 2.4 D Turbo	2,4	70		09.92-04.96	ZWB					
		75		08.85-08.92	ABM					
			Fg.no. →29-M-009 906	08.89-11.90						
LT [29, 21]	2,4	75	Fg.no. →29-M-009 906	09.85-11.90						
40 2.4 D Turbo 4x4										
40 2.4 D 4x4	2,4	55	Fg.no. →29-M-009 906	09.85-11.90						
40 2.4 4x4	2,4	66	Fg.no. →29-M-009 906	09.85-11.90						
45 2.4 D Turbo 4x4	2,4	75	Fg.no. →29-M-009 906	09.85-11.90						
45 2.4 D 4x4	2,4	55	Fg.no. →29-M-009 906	09.85-11.90						
45 2.4 4x4	2,4	66	Fg.no. →29-M-009 906	09.85-11.90						
Multivan T4 [70, 7D] 1.8	1,8	49		12.90-07.92						
					280	0986 478 871	280 / 12	GIR	0986 494 051	23 224
					280,WW,XXX			GIR	0986 424 748	23 224
					294	0986 478 569	294 / 13,5	GIR	0986 494 025	23 446
					294,WW,XXX			GIR	0986 424 542	23 446
1.9 D	1,9	45		09.90-04.97						
					280	0986 478 871	280 / 12	GIR	0986 494 051	23 224
					280,WW,XXX			GIR	0986 424 748	23 224
					294	0986 478 569	294 / 13,5	GIR	0986 494 025	23 446
					294,WW,XXX			GIR	0986 424 542	23 446
1.9 D Turbo	1,9	50		10.92-06.03						
					280	0986 478 871	280 / 12	GIR	0986 494 051	23 224
					280,WW,XXX			GIR	0986 424 748	23 224
					294	0986 478 569	294 / 13,5	GIR	0986 494 025	23 446
					294,WW,XXX			GIR	0986 424 542	23 446
2.0	2,0	62		09.90-06.03						
					280	0986 478 871	280 / 12	GIR	0986 494 051	23 224
					280,WW,XXX			GIR	0986 424 748	23 224
					294	0986 478 569	294 / 13,5	GIR	0986 494 025	23 446
					294,WW,XXX			GIR	0986 424 542	23 446
2.4 D	2,4	55		05.97-06.03						
					280	0986 478 871	280 / 12	GIR	0986 494 051	23 224
					280,WW,XXX			GIR	0986 424 748	23 224
					294	0986 478 569	294 / 13,5	GIR	0986 494 025	23 446
					294,WW,XXX			GIR	0986 424 542	23 446
		57		09.90-05.98						
					280	0986 478 871	280 / 12	GIR	0986 494 051	23 224
					280,WW,XXX			GIR	0986 424 748	23 224
					294	0986 478 569	294 / 13,5	GIR	0986 494 025	23 446
					294,WW,XXX			GIR	0986 424 542	23 446





												
				0 986 477 035 270X73								
				0 986 477 035 270X73								
								0 986 487 318 252X56				
				0 986 477 035 270X73				0 986 487 389 270X66				
				0 986 477 035 270X73								
								0 986 487 318 252X56				
				0 986 477 035 270X73				0 986 487 389 270X66				
				0 986 477 035 270X73								
								0 986 487 318 252X56				
				0 986 477 035 270X73				0 986 487 318 252X56			1 987 475 216	
				0 986 477 035 270X73				0 986 487 318 252X56			1 987 475 216	
				0 986 477 035 270X73				0 986 487 318 252X56			1 987 475 216	
				0 986 477 035 270X73				0 986 487 318 252X56			1 987 475 216	
				0 986 477 035 270X73				0 986 487 318 252X56			1 987 475 216	
				0 986 477 035 270X73				0 986 487 318 252X56			1 987 475 216	
				0 986 477 046 268X67,5				0 986 487 312 270X55			1 987 475 133	
17,3												
16,5	1 987 474 264											
16,5												
				0 986 477 046 268X67,5				0 986 487 312 270X55			1 987 475 133	
17,3												
16,5	1 987 474 264											
16,5												
				0 986 477 046 268X67,5				0 986 487 312 270X55			1 987 475 133	
17,3												
16,5	1 987 474 264											
16,5												
				0 986 477 046 268X67,5				0 986 487 312 270X55			1 987 475 133	
17,3												
16,5	1 987 474 264											
16,5												
				0 986 477 046 268X67,5				0 986 487 312 270X55			1 987 475 133	
17,3												
16,5	1 987 474 264											
16,5												
				0 986 477 046 268X67,5				0 986 487 312 270X55			1 987 475 133	
17,3												
16,5	1 987 474 264											
16,5												
				0 986 477 046 268X67,5				0 986 487 312 270X55			1 987 475 133	
17,3												
16,5	1 987 474 264											
16,5												





◀ VW										
Multivan T4 [70, 7D]	2,4	57	11.92-09.98	280	0986 478 871	280 / 12	GIR	0986 494 051	23 224	
				280,WW,XXX			GIR	0986 424 748	23 224	
				294	0986 478 569	294 / 13,5	GIR	0986 494 025	23 446	
				294,WW,XXX			GIR	0986 424 542	23 446	
2.5	2,5	81	11.90-12.93	280	0986 478 871	280 / 12	GIR	0986 494 051	23 224	
				280,WW,XXX			GIR	0986 424 748	23 224	
				294	0986 478 569	294 / 13,5	GIR	0986 494 025	23 446	
				294,WW,XXX			GIR	0986 424 542	23 446	
			07.94-06.03	280	0986 478 871	280 / 12	GIR	0986 494 051	23 224	
				280,WW,XXX			GIR	0986 424 748	23 224	
				294	0986 478 569	294 / 13,5	GIR	0986 494 025	23 446	
				294,WW,XXX			GIR	0986 424 542	23 446	
		85	08.96-06.03	280	0986 478 871	280 / 12	GIR	0986 494 051	23 224	
				280,WW,XXX			GIR	0986 424 748	23 224	
				294	0986 478 569	294 / 13,5	GIR	0986 494 025	23 446	
				294,WW,XXX			GIR	0986 424 542	23 446	
2.5 Syncro	2,5	81	11.92-10.96	280	0986 478 871	280 / 12	GIR	0986 494 051	23 224	
				280,WW,XXX			GIR	0986 424 748	23 224	
				294	0986 478 569	294 / 13,5	GIR	0986 494 025	23 446	
				294,WW,XXX			GIR	0986 424 542	23 446	
			06.97-11.01	280	0986 478 871	280 / 12	GIR	0986 494 051	23 224	
				280,WW,XXX			GIR	0986 424 748	23 224	
				294	0986 478 569	294 / 13,5	GIR	0986 494 025	23 446	
				294,WW,XXX			GIR	0986 424 542	23 446	
		85	08.96-06.03	280	0986 478 871	280 / 12	GIR	0986 494 051	23 224	
				280,WW,XXX			GIR	0986 424 748	23 224	
				294	0986 478 569	294 / 13,5	GIR	0986 494 025	23 446	
				294,WW,XXX			GIR	0986 424 542	23 446	
2.5 TDI	2,5	65	05.98-06.03	280	0986 478 871	280 / 12	GIR	0986 494 051	23 224	
				280,WW,XXX			GIR	0986 424 748	23 224	
				294	0986 478 569	294 / 13,5	GIR	0986 494 025	23 446	
				294,WW,XXX			GIR	0986 424 542	23 446	
		75	01.95-06.03	280	0986 478 871	280 / 12	GIR	0986 494 051	23 224	
				280,WW,XXX			GIR	0986 424 748	23 224	
				294	0986 478 569	294 / 13,5	GIR	0986 494 025	23 446	
				294,WW,XXX			GIR	0986 424 542	23 446	



											
17,3				0 986 477 046 268X67,5				0 986 487 312 270X55			1 987 475 133
16,5	1 987 474 264										
16,5											
17,3				0 986 477 046 268X67,5				0 986 487 312 270X55			1 987 475 133
16,5	1 987 474 264										
16,5											
17,3				0 986 477 046 268X67,5				0 986 487 312 270X55			1 987 475 133
16,5	1 987 474 264										
16,5											
17,3				0 986 477 046 268X67,5				0 986 487 312 270X55			1 987 475 133
16,5	1 987 474 264										
16,5											
17,3				0 986 477 046 268X67,5				0 986 487 312 270X55			1 987 475 133
16,5	1 987 474 264										
16,5											
17,3				0 986 477 046 268X67,5				0 986 487 312 270X55			1 987 475 133
16,5	1 987 474 264										
16,5											
17,3				0 986 477 046 268X67,5				0 986 487 312 270X55			1 987 475 133
16,5	1 987 474 264										
16,5											
17,3				0 986 477 046 268X67,5				0 986 487 312 270X55			1 987 475 133
16,5	1 987 474 264										
16,5											
17,3				0 986 477 046 268X67,5				0 986 487 312 270X55			1 987 475 133
16,5	1 987 474 264										
16,5											





◀ VW

Multivan T4 [70, 7D] 2.5 TDI		2,5	111	05.98-09.00					
					280	0986 478 871	280 / 12	GIR	0986 494 051 23 224
					280,WW,XXX			GIR	0986 424 748 23 224
					294	0986 478 569	294 / 13,5	GIR	0986 494 025 23 446
					294,WW,XXX			GIR	0986 424 542 23 446
		2,5	75	03.98-06.03					
					280	0986 478 871	280 / 12	GIR	0986 494 051 23 224
					280,WW,XXX			GIR	0986 424 748 23 224
					294	0986 478 569	294 / 13,5	GIR	0986 494 025 23 446
					294,WW,XXX			GIR	0986 424 542 23 446
					PR no. 2E3				
					1KX			GIR	0986 494 025 23 446
2.8		2,8	103	01.96-05.00					
					280	0986 478 871	280 / 12	GIR	0986 494 051 23 224
					280,WW,XXX			GIR	0986 424 748 23 224
					294	0986 478 569	294 / 13,5	GIR	0986 494 025 23 446
					294,WW,XXX			GIR	0986 424 542 23 446
					150				
					280	0986 478 871	280 / 12	GIR	0986 494 051 23 224
					280,WW,XXX			GIR	0986 424 748 23 224
					294	0986 478 569	294 / 13,5	GIR	0986 494 025 23 446
					294,WW,XXX			GIR	0986 424 542 23 446
Multivan T5 [7H] 1.9 TDI		1,9	62	01.06→					
					294,BVA,MVB				0986 494 108 23882
					294,INB	0986 479 097	294 / 21,9		
					322,INB	0986 479 094	314 / 22		
					63				
					294,BVA,MVB				0986 494 108 23882
					294,INB	0986 479 097	294 / 21,9		
					322,INB	0986 479 094	314 / 22		
					75				
					294,BVA,MVB				0986 494 108 23882
					294,INB	0986 479 097	294 / 21,9		
					322,INB	0986 479 094	314 / 22		
					77				
					294,BVA,MVB				0986 494 108 23882
					294,INB	0986 479 097	294 / 21,9		
					322,INB	0986 479 094	314 / 22		
2.0		2,0	85	06.03→					
					294,BVA,MVB				0986 494 108 23882
					294,INB	0986 479 097	294 / 21,9		
					322,INB	0986 479 094	314 / 22		
2.5 TDI		2,5	96	02.03→					
					294,BVA,MVB				0986 494 108 23882
					294,INB	0986 479 097	294 / 21,9		
					322,INB	0986 479 094	314 / 22		



												
17,3				0 986 477 046 268X67,5			0 986 487 312 270X55		1 987 475 133			
16,5	1 987 474 264											
16,5												
17,3				0 986 477 046 268X67,5			0 986 487 312 270X55		1 987 475 133			
16,5	1 987 474 264											
16,5												
16,5				0 986 477 046 268X67,5			0 986 487 312 270X55		1 987 475 133			
16,5	1 987 474 264											
16,5												
17,3				0 986 477 046 268X67,5			0 986 487 312 270X55		1 987 475 133			
16,5	1 987 474 264											
16,5												
17,5												0 986 487 625
17,5												0 986 487 625
17,5												0 986 487 625
17,5												0 986 487 625
17,5												0 986 487 625
17,5												0 986 487 625
17,5												0 986 487 625





◀ VW											
Multivan T5 [7H] 2.5 TDI	2,5	120	11.03→	294,BVA, MVB						0 986 494 108	23882
				294,INB	0 986 479 097	294 / 21,9					
				322,INB	0 986 479 094	314 / 22					
		128	02.03→	294,BVA, MVB						0 986 494 108	23882
				294,INB	0 986 479 097	294 / 21,9					
				322,INB	0 986 479 094	314 / 22					
2.5 TDI 4 Motion	2,5	96	07.04→	294,BVA						0 986 494 108	23882
				294,INB	0 986 479 097	294 / 21,9					
				322,INB	0 986 479 094	314 / 22					
		128	07.04→	294,BVA						0 986 494 108	23882
				294,INB	0 986 479 097	294 / 21,9					
				322,INB	0 986 479 094	314 / 22					
3.2	3,2	170	02.03-06.04	294,BVA, MVB						0 986 494 108	23882
				294,INB	0 986 479 097	294 / 21,9					
				322,INB	0 986 479 094	314 / 22					
		173	05.03→	294,BVA, MVB						0 986 494 108	23882
				294,INB	0 986 479 097	294 / 21,9					
				322,INB	0 986 479 094	314 / 22					
3.2 4 Motion	3,2	173	07.04→	294,BVA						0 986 494 108	23882
				294,INB	0 986 479 097	294 / 21,9					
				322,INB	0 986 479 094	314 / 22					
Saveiro III 1.9 D	1,9	47	06.98-05.02	ABS							
Taro [7A] 1.8	1,8	61	04.89-09.94								
2.2	2,2	69	06.89-07.94								
2.4	2,4	84,4	06.89-03.97								
2.4 D	2,4	58-61	04.89-03.97								
2.4 D 4x4	2,4	58-61	04.89-03.97	WW							
Transporter T3 [24, 25] 1.6 D	1,6	37	01.81-07.87								
				NOR							
				VEA							
1.6 D Turbo	1,6	51	08.84-07.92								
				NOR							
				VEA							
1.6 D Turbo Syncro	1,6	51	03.86-07.92	14Z,NOR							
				14Z,VEA							
				16Z							
1.7 D	1,7	42	10.86-07.92								
				NOR							
				VEA							
1.9	1,9	40	03.83-05.88								
				NOR							
				VEA							
		44	08.82-07.92								
				NOR							
				VEA							
		54	08.86-10.88								
				NOR							
				VEA							
		57	09.82-07.92								
				NOR							
				VEA							









◀ VW											
Transporter T3 [24, 25] 1.9	1.9	60	01.83-07.85	NOR							
				VEA							
		66		10.83-07.85	NOR						
					VEA						
	1.9 Syncro	1.9	54	10.86-10.88	14Z,NOR						
					14Z,VEA						
		57	02.85-07.92	14Z,NOR							
				14Z,VEA							
	2.1	2.1	64	10.86-07.92	NOR						
					VEA						
		68	08.89-07.92	NOR							
				VEA							
70		08.85-07.92	NOR								
			VEA								
82		07.85-07.92	NOR								
			VEA								
2.1 Syncro	2.1	64	10.86-07.92	14Z,NOR							
				14Z,VEA							
	70	08.85-07.92	14Z,NOR								
			14Z,VEA								
	82	01.86-07.92	14Z,NOR								
			14Z,VEA								
Transporter T4 [70, 7D] 1.8	1.8	49	12.90-07.92	280	0986 478 871	280 / 12	GIR	0986 494 051	23 224		
				280,WW,XXX			GIR	0986 424 748	23 224		
		294		12.90-07.92	294	0986 478 569	294 / 13,5	GIR	0986 494 025	23 446	
					294,WW,XXX			GIR	0986 424 542	23 446	
	1.9 D	1.9	45	09.90-04.97	280	0986 478 871	280 / 12	GIR	0986 494 051	23 224	
					280,WW,XXX			GIR	0986 424 748	23 224	
			294		09.90-04.97	294	0986 478 569	294 / 13,5	GIR	0986 494 025	23 446
						294,WW,XXX			GIR	0986 424 542	23 446
		1.9 D Turbo	1.9	50	10.92-06.03	280	0986 478 871	280 / 12	GIR	0986 494 051	23 224
						280,WW,XXX			GIR	0986 424 748	23 224
			294		10.92-06.03	294	0986 478 569	294 / 13,5	GIR	0986 494 025	23 446
						294,WW,XXX			GIR	0986 424 542	23 446
2.0	2.0		62	09.90-06.03	280	0986 478 871	280 / 12	GIR	0986 494 051	23 224	
					280,WW,XXX			GIR	0986 424 748	23 224	
		294		09.90-06.03	294	0986 478 569	294 / 13,5	GIR	0986 494 025	23 446	
					294,WW,XXX			GIR	0986 424 542	23 446	





◀ VW										
Transporter T4 [70, 7D]	2.4 D	2,4	55	05.97-06.03						
					280	0986 478 871	280 / 12	GIR	0986 494 051	23 224
					280,WW,XXX			GIR	0986 424 748	23 224
					294	0986 478 569	294 / 13,5	GIR	0986 494 025	23 446
					294,WW,XXX			GIR	0986 424 542	23 446
			57	09.90-05.98						
					280	0986 478 871	280 / 12	GIR	0986 494 051	23 224
					280,WW,XXX			GIR	0986 424 748	23 224
					294	0986 478 569	294 / 13,5	GIR	0986 494 025	23 446
					294,WW,XXX			GIR	0986 424 542	23 446
2.4 D Syncro		2,4	57	11.92-09.98						
					280	0986 478 871	280 / 12	GIR	0986 494 051	23 224
					280,WW,XXX			GIR	0986 424 748	23 224
					294	0986 478 569	294 / 13,5	GIR	0986 494 025	23 446
					294,WW,XXX			GIR	0986 424 542	23 446
2.5		2,5	81	11.90-06.03						
					280	0986 478 871	280 / 12	GIR	0986 494 051	23 224
					280,WW,XXX			GIR	0986 424 748	23 224
					294	0986 478 569	294 / 13,5	GIR	0986 494 025	23 446
					294,WW,XXX			GIR	0986 424 542	23 446
			85	08.96-06.03						
					280	0986 478 871	280 / 12	GIR	0986 494 051	23 224
					280,WW,XXX			GIR	0986 424 748	23 224
					294	0986 478 569	294 / 13,5	GIR	0986 494 025	23 446
					294,WW,XXX			GIR	0986 424 542	23 446
			2,5	81	11.92-10.96					
					280	0986 478 871	280 / 12	GIR	0986 494 051	23 224
					280,WW,XXX			GIR	0986 424 748	23 224
					294	0986 478 569	294 / 13,5	GIR	0986 494 025	23 446
					294,WW,XXX			GIR	0986 424 542	23 446
				06.97-11.01						
					280	0986 478 871	280 / 12	GIR	0986 494 051	23 224
					280,WW,XXX			GIR	0986 424 748	23 224
					294	0986 478 569	294 / 13,5	GIR	0986 494 025	23 446
					294,WW,XXX			GIR	0986 424 542	23 446
			85	05.96-06.03						
					280	0986 478 871	280 / 12	GIR	0986 494 051	23 224
					280,WW,XXX			GIR	0986 424 748	23 224
					294	0986 478 569	294 / 13,5	GIR	0986 494 025	23 446
					294,WW,XXX			GIR	0986 424 542	23 446
			2,5	65	05.98-06.03					
					280	0986 478 871	280 / 12	GIR	0986 494 051	23 224
					280,WW,XXX			GIR	0986 424 748	23 224
					294	0986 478 569	294 / 13,5	GIR	0986 494 025	23 446
					294,WW,XXX			GIR	0986 424 542	23 446



											
17,3				0 986 477 046 268X67,5				0 986 487 312 270X55		1 987 475 133	
16,5	1 987 474 264										
16,5											
17,3				0 986 477 046 268X67,5				0 986 487 312 270X55		1 987 475 133	
16,5	1 987 474 264										
16,5											
17,3				0 986 477 046 268X67,5				0 986 487 312 270X55		1 987 475 133	
16,5	1 987 474 264										
16,5											
17,3				0 986 477 046 268X67,5				0 986 487 312 270X55		1 987 475 133	
16,5	1 987 474 264										
16,5											
17,3				0 986 477 046 268X67,5				0 986 487 312 270X55		1 987 475 133	
16,5	1 987 474 264										
16,5											
17,3				0 986 477 046 268X67,5				0 986 487 312 270X55		1 987 475 133	
16,5	1 987 474 264										
16,5											
17,3				0 986 477 046 268X67,5				0 986 487 312 270X55		1 987 475 133	
16,5	1 987 474 264										
16,5											
17,3				0 986 477 046 268X67,5				0 986 487 312 270X55		1 987 475 133	
16,5	1 987 474 264										
16,5											





◀ VW

Transporter T4 [70, 7D] 2.5		2,5	75	01.95-06.03						
					280	0986 478 871	280 / 12	GIR	0986 494 051	23 224
					280,WW,XXX			GIR	0986 424 748	23 224
					294	0986 478 569	294 / 13,5	GIR	0986 494 025	23 446
					294,WW,XXX			GIR	0986 424 542	23 446
		111		05.98-06.03						
					280	0986 478 871	280 / 12	GIR	0986 494 051	23 224
					280,WW,XXX			GIR	0986 424 748	23 224
					294	0986 478 569	294 / 13,5	GIR	0986 494 025	23 446
					294,WW,XXX			GIR	0986 424 542	23 446
		2,5	75	03.98-06.03						
					280	0986 478 871	280 / 12	GIR	0986 494 051	23 224
					280,WW,XXX			GIR	0986 424 748	23 224
					294	0986 478 569	294 / 13,5	GIR	0986 494 025	23 446
					294,WW,XXX			GIR	0986 424 542	23 446
					PR no. 2E3			GIR	0986 494 025	23 446
2.8		2,8	103	04.01-06.03	1KX			GIR	0986 494 025	23 446
				01.96-05.00						
					280	0986 478 871	280 / 12	GIR	0986 494 051	23 224
					280,WW,XXX			GIR	0986 424 748	23 224
					294	0986 478 569	294 / 13,5	GIR	0986 494 025	23 446
					294,WW,XXX			GIR	0986 424 542	23 446
		150		05.00-06.03						
					280	0986 478 871	280 / 12	GIR	0986 494 051	23 224
					280,WW,XXX			GIR	0986 424 748	23 224
					294	0986 478 569	294 / 13,5	GIR	0986 494 025	23 446
					294,WW,XXX			GIR	0986 424 542	23 446
Transporter T5 [7H] 1.9 TDI		1,9	62	01.06→						
					294,BVA,MVB				0986 494 108	23882
					294,INB	0986 479 097	294 / 21,9			
					322,INB	0986 479 094	314 / 22			
		63		04.03→						
					294,BVA,MVB				0986 494 108	23882
					294,INB	0986 479 097	294 / 21,9			
					322,INB	0986 479 094	314 / 22			
		75		01.06→						
					294,BVA,MVB				0986 494 108	23882
					294,INB	0986 479 097	294 / 21,9			
					322,INB	0986 479 094	314 / 22			
		77		04.03→						
					294,BVA,MVB				0986 494 108	23882
					294,INB	0986 479 097	294 / 21,9			
					322,INB	0986 479 094	314 / 22			
2.0		2,0	85	06.03→						
					294,BVA,MVB				0986 494 108	23882
					294,INB	0986 479 097	294 / 21,9			
					322,INB	0986 479 094	314 / 22			



						S				S		
17,3				0 986 477 046 268X67,5			0 986 487 312 270X55		1 987 475 133			
16,5	1 987 474 264											
16,5												
17,3				0 986 477 046 268X67,5			0 986 487 312 270X55		1 987 475 133			
16,5	1 987 474 264											
16,5												
17,3				0 986 477 046 268X67,5			0 986 487 312 270X55		1 987 475 133			
16,5	1 987 474 264											
16,5												
17,3				0 986 477 046 268X67,5			0 986 487 312 270X55		1 987 475 133			
16,5	1 987 474 264											
16,5												
17,5												0 986 487 625
17,5												0 986 487 625
17,5												0 986 487 625
17,5												0 986 487 625
17,5												0 986 487 625





◀ VW

Transporter T5 [7H] 2.5 TDI	2,5	96	02.03→	294,BVA, MVB			0986 494 108	23882
				294,INB	0986 479 097	294 / 21,9		
				322,INB	0986 479 094	314 / 22		
120	11.03→	294,BVA, MVB			0986 494 108	23882		
		294,INB	0986 479 097	294 / 21,9				
		322,INB	0986 479 094	314 / 22				
128	02.03→	294,BVA, MVB			0986 494 108	23882		
		294,INB	0986 479 097	294 / 21,9				
		322,INB	0986 479 094	314 / 22				
2.5 TDI 4 Motion	2,5	96	07.04→	294,BVA			0986 494 108	23882
				294,INB	0986 479 097	294 / 21,9		
				322,INB	0986 479 094	314 / 22		
128	07.04→	294,BVA			0986 494 108	23882		
		294,INB	0986 479 097	294 / 21,9				
		322,INB	0986 479 094	314 / 22				
3.2	3,2	170	02.03-06.04	294,BVA, MVB			0986 494 108	23882
				294,INB	0986 479 097	294 / 21,9		
				322,INB	0986 479 094	314 / 22		
173	05.03→	294,BVA, MVB			0986 494 108	23882		
		294,INB	0986 479 097	294 / 21,9				
		322,INB	0986 479 094	314 / 22				
3.2 4 Motion	3,2	173	07.04→	294,BVA			0986 494 108	23882
				294,INB	0986 479 097	294 / 21,9		
				322,INB	0986 479 094	314 / 22		
Transporter T5 [7J] 1.9 TDI	1,9	62	06.06→	294,BVA			0986 494 108	23882
				294,INB	0986 479 097	294 / 21,9		
				322,INB	0986 479 094	314 / 22		
63	04.03→	294,BVA			0986 494 108	23882		
		294,INB	0986 479 097	294 / 21,9				
		322,INB	0986 479 094	314 / 22				
75	06.06→	294,BVA			0986 494 108	23882		
		294,INB	0986 479 097	294 / 21,9				
		322,INB	0986 479 094	314 / 22				
77	04.03→	294,BVA			0986 494 108	23882		
		294,INB	0986 479 097	294 / 21,9				
		322,INB	0986 479 094	314 / 22				
2.0	2,0	85	06.03→	294,BVA			0986 494 108	23882
				294,INB	0986 479 097	294 / 21,9		
				322,INB	0986 479 094	314 / 22		
2.5 TDI	2,5	96	04.03→	294,BVA			0986 494 108	23882
				294,INB	0986 479 097	294 / 21,9		
				322,INB	0986 479 094	314 / 22		















◀ VW

Transporter T5 [7J] 2.5 TDI	2,5	128	01.04→	294,BVA		0986 494 108	23882
				294,INB	0986 479 097	294 / 21,9	
				322,INB	0986 479 094	314 / 22	
2.5 TDI 4 Motion	2,5	96	07.04→	294,BVA		0986 494 108	23882
				294,INB	0986 479 097	294 / 21,9	
				322,INB	0986 479 094	314 / 22	
		128	07.04→	294,BVA		0986 494 108	23882
				294,INB	0986 479 097	294 / 21,9	
				322,INB	0986 479 094	314 / 22	
3.2	3,2	170	02.04→	294,BVA		0986 494 108	23882
				294,INB	0986 479 097	294 / 21,9	
				322,INB	0986 479 094	314 / 22	
3.2 4 Motion	3,2	170	07.04→	294,BVA		0986 494 108	23882
				294,INB	0986 479 097	294 / 21,9	
				322,INB	0986 479 094	314 / 22	



					S				S		
17,5											0 986 487 625
17,5											0 986 487 625
17,5											0 986 487 625
17,5											0 986 487 625
17,5											0 986 487 625



de

Gegenüberstellung**Benutzerhinweise**

Im nachfolgenden Katalogteil sind Bestellnummern von Herstellern anderer Marken, für die es einbaugleiche Bosch-Erzeugnisse oder -Teile gibt, aufgeführt. Da die verschiedenartigsten Bezeichnungssysteme angewendet werden, konnten die fremden Bestellnummern nur in einer einheitlichen, alphanumerischen Sortierfolge geordnet werden. Sie weicht bei einigen Herstellern von der dort üblichen Sortierfolge ab. Eine Rückumschlüsselung von Bosch- zu Fremdnummern ist nicht zulässig.

Hinweis

Aus wettbewerbsrechtlichen Gründen dürfen gegenüber Endkunden zur Kennzeichnung von Bosch-Teilen nur die Bosch-Teilenummern verwendet werden.

en

Cross-reference**Notes for users**

The following catalog section lists part numbers of non-Bosch equipment for which there are interchangeable Bosch products or components available. Since a wide range of different designation systems are used, we were forced to arrange the non-Bosch part numbers in a uniform alphanumerical order. This differs from the customary order employed by some manufacturers. Reconversion of Bosch numbers back to the numbers of other manufacturers is not permitted.

Note

The laws governing competition stipulate that only Bosch type numbers may be used vis-à-vis the final customer for the identification of Bosch parts.

fr

Table de correspondance**A l'attention de l'utilisateur**

Cette section du catalogue reprend les références des fabricants d'autres marques pour lesquelles il existe des produits ou des composants Bosch de montage identique. De multiples systèmes de codage étant utilisés, les références des produits d'autres marques ne peuvent être reprises que suivant un classement alphanumérique uniforme. Pour certains fabricants, ce classement peut différer de celui qu'ils utilisent habituellement. La re-conversion de références Bosch en références d'autres marques n'est pas autorisée.

Remarque

En raison des dispositions légales concernant la concurrence seules les références Bosch peuvent être utilisées vis-à-vis des clients finaux pour l'identification des pièces Bosch.

it

Comparazione**Avvertenze per la consultazione**

Nella seguente parte del catalogo vengono riportati i numeri di ordinazione di costruttori di prodotti d'altra marca, per i quali sono disponibili prodotti o parti di prodotti Bosch di corrispondente applicazione. Dato che vengono utilizzati i più diversi sistemi di denominazione, si è potuto ordinare i numeri di ordinazione di altra marca solo in una sequenza di classificazione unitaria ed alfanumerica. Per alcune case costruttrici si differenzia perciò dalla sequenza di classificazione normalmente usata. In questo confronto le sigle Bosch vanno considerate come dati indicativi. Non è ammessa una ricodificazione da numeri di ordinazione Bosch a numeri di altra marca.

Avvertenza

Per motivi legati ai diritti che regolano la concorrenza, per l'identificazione dei componenti Bosch destinati all'utente finale, possono essere impiegati solo i codici Bosch.

es

Equivalencias**Indicaciones para el usuario**

A continuación se han relacionado números de pedido de fabricantes de otras marcas para los que existen productos o piezas Bosch de iguales características. Dado que se utilizan los más diversos sistemas de designación, los números de pedido ajenos han podido relacionarse tan sólo en un orden unificado, alfanumérico. En el caso de algunos fabricantes, el orden de esta clasificación difiere del que utilizan habitualmente. No es admisible la recodificación de los números de Bosch en números ajenos.

Nota

Por aspectos legales relativos a la competencia, de cara a los clientes finales únicamente deben utilizarse los números de piezas tipo Bosch para identificar piezas Bosch.

ALFA ROMEO

105 12 22 014 00	0 986 478 402
115105	0 986 478 213
11 600 262 1504	0 986 478 735

11 638 220 1401	0 986 478 738
11 646 220 1402	0 986 478 760
11 646 262 1501	0 986 478 739
11 650 220 1401	0 986 478 736
11 650 220 1402	0 986 478 736

11 650 262 1500	0 986 478 737
11 650 262 1501	0 986 478 737
128573	0 986 478 213
130474	0 986 478 212
16 100 220 1401	0 986 478 736

16 150 262 1501	0 986 478 737
16 206 220 1400	0 986 478 766
16 406 261 0001	0 986 478 341
16 410 220 23	0 986 478 521
16 420 220 2302	0 986 478 237

16 420 220 2303	0 986 478 237
16 420 261 0001	0 986 478 238
1904529	0 986 478 742
4340810	0 986 487 271
4340811	0 986 487 271

4377102	0 986 478 740
4379680	0 986 477 055
46403088	0 986 478 810
46403959	0 986 478 810
46416712	0 986 478 515

46419204	0 986 478 878
46843608	0 986 479 293
46843610	0 986 479 378
51760273	0 986 479 378
51760621	0 986 479 293

51767377	0 986 479 292
51767378	0 986 479 292
51767381	0 986 479 291
51767382	0 986 479 291
51767383	0 986 479 290

51767384	0 986 479 290
548195	0 986 478 228
5888433	0 986 487 250
5888453	0 986 487 255
5890500	0 986 487 250

60501453	0 986 478 212
60514881	0 986 478 228
60516371	0 986 478 402
60520463	0 986 487 202
60522092	0 986 478 760

60526087	0 986 478 736
60526121	0 986 478 737
60533595	0 986 478 766
60533706	0 986 478 738
60533971	0 986 478 739

60551775	0 986 478 521
60569163	0 986 478 521
60569164	0 986 478 341
60571548	0 986 478 521
60576335	0 986 478 342

60576811	0 986 478 107
60578920	0 986 478 444
60617106	0 986 478 668
60621051	0 986 478 107
60622077	0 986 478 521

60629865	0 986 478 669
60651437	0 986 478 444
60652186	0 986 478 711
60653478	0 986 478 521
60653479	0 986 478 341

60653487	0 986 478 668
60658565	0 986 478 521
60658566	0 986 478 341
60658567	0 986 478 668
60670801	0 986 478 711

60702446	0 986 478 738
60703170	0 986 478 735
60749883	0 986 487 546
60750467	0 986 487 546
60750472	0 986 487 295

60801722	0 986 478 521
60801751	0 986 478 512
60801754	0 986 478 237
60801755	0 986 478 238
60801786	0 986 478 341

60801787	0 986 478 341
60805117	0 986 478 342
608 06 135	0 986 478 810
60806137	0 986 478 515
60808872	0 986 478 343

60810025	0 986 477 088
60810038	0 986 487 255
60810076	0 986 478 515
60811256	0 986 478 515
60811266	0 986 478 515

60811879	0 986 478 342
60811890	0 986 478 786
60812067	0 986 478 786
60812422	0 986 478 810
60814639	0 986 478 460

60814646	0 986 478 463
60814921	0 986 478 669
71711434	0 986 478 521
71711447	0 986 478 521
7545556	0 986 478 343

7569600	0 986 477 088
7645054	0 986 478 342
7645055	0 986 478 343
7663465	0 986 478 342
7663466	0 986 478 343

77362295	0 986 487 597
77362296	0 986 487 596
77363959	0 986 494 222
77363992	0 986 494 132
77364473	0 986 494 132

77364919	0 986 494 132
7750119	0 986 477 083
7777842	0 986 477 055
7789267	0 986 478 341
82427592	0 986 478 521

82 433 918	0 986 478 810
82 440 356	0 986 478 810
82450539	0 986 478 521
82 450 657	0 986 478 810
82 451 746	0 986 478 810

82488240	0 986 478 463
92498609	0 986 478 343
93800492	0 986 478 742
96609633	0 986 478 213
9945371	0 986 487 331

9946561	0 986 487 313
9947106	0 986 487 295
9948372	0 986 487 597
9948373	0 986 487 596
9950814	0 986 487 295

AUSTIN

101 0513	1 987 475 202
----------	----------------------

BEDFORD

90 077 721	0 986 477 022
90 111 242	0 986 478 081

CHEVROLET

55311 80F02	0 986 478 721
93 233 878	0 204 072 233
96 268 686	0 986 487 628

96 405 131	0 986 494 133
96 446 178	0 986 487 628
96 473 229	0 986 487 714
96 534 653	0 986 424 818
96 549 782	0 986 479 328

CITROEN

AM 451 016 A	0 986 487 447
AM 451 018 A	0 986 487 322
AM 451 23	0 986 478 050

AZ 451 016 A	0 986 487 124
AZ 451 19	0 986 487 322
GX 211 700 1A	0 986 478 231
ZF 04 449 694	0 986 477 031
ZF 04 450 931	0 986 478 067

ZF 07 531 819	0 986 478 200
ZF 07 568 501	0 986 478 067
ZF 44 509 31	0 986 478 067
ZF 93 500 521	0 986 478 234
3701 40	0 986 478 091

4236 14	0 986 487 081
4236 46	0 986 487 020
4236 49	0 986 487 081
4238 10	0 986 487 456
4238 20	0 986 487 441

4238 23	0 986 487 441
4238 33	0 986 487 403
4238 35	0 986 487 413
4238 38	0 986 487 499
4238 40	0 986 487 319

4238 46	0 986 487 020
4238 49	0 986 487 020
4238 80	0 986 487 437
4238 83	0 986 487 076
4238 83	0 986 487 381

4238 86	0 986 487 076
4238 86	0 986 487 381
4238 96	0 986 487 456
4238 99	0 986 487 128
4241 A3	0 986 487 449

4241 A4	0 986 487 336
4241 E5	0 986 487 533
4241 E6	0 986 487 084
4241 E7	0 986 487 252
4241 E8	0 986 487 274

4241 E9	0 986 487 383
4241 G3	0 986 487 346
4241 G5	0 986 487 383
4241 G6	0 986 487 567
4241 G7	0 986 487 606

4241 H4	0 986 487 521
4241 H5	0 986 487 522
4241 H6	0 986 487 749
4241 H7	0 986 487 545
4241 H8	0 986 487 128

4241 H9	0 986 487 313
4241 J1	0 986 487 585
4241 J2	0 986 487 579
4241 J3	0 986 487 383
4241 J4	0 986 487 549

4241 J5	0 986 487 585	4246 A5	0 986 478 046	4246 P7	0 986 479 193	4246 91	0 986 478 189
4241 J6	0 986 487 274	4246 A6	0 986 478 211	4246 P8	0 986 479 192	4246 93	0 986 478 200
4241 J7	0 986 487 579	4246 A7	0 986 478 370	4246 P9	0 986 479 194	4246 94	0 986 478 370
4241 J8	0 986 487 552	4246 A8	0 986 478 089	4246 R2	0 986 478 847	4246 95	0 986 478 200
4241 J9	0 986 487 274	4246 A9	0 986 478 090	4246 R3	0 986 478 268	4246 96	0 986 478 067
4241 K1	0 986 487 567	4246 B1	0 986 478 268	4246 R4	0 986 478 847	4246 97	0 986 478 268
4241 K2	0 986 487 567	4246 B2	0 986 478 091	4246 R5	0 986 478 268	4246 98	0 986 478 094
4241 K3	0 986 487 567	4246 B3	0 986 478 067	4246 R6	0 986 478 980	4246 99	0 986 478 371
4241 K4	0 986 487 579	4246 B4	0 986 478 200	4246 R7	0 986 478 831	4247 21	0 986 477 097
4241 K5	0 986 487 568	4246 B7	0 986 478 801	4246 R8	0 986 478 887	4247 22	0 986 477 031
4241 K6	0 986 487 545	4246 B8	0 986 478 770	4246 R9	0 986 478 887	4247 24	0 986 477 060
4241 K8	0 986 487 552	4246 C0	0 986 479 288	4246 T1	0 986 479 024	4247 25	0 986 477 020
4241 K9	0 986 487 579	4246 E0	0 986 479 192	4246 T2	0 986 479 026	4247 27	0 986 477 019
4241 L0	0 986 487 664	4246 E4	0 986 478 121	4246 T6	0 986 478 877	4247 30	0 986 477 019
4241 L1	0 986 487 712	4246 E7	0 986 478 140	4246 T7	0 986 478 877	4247 31	0 986 477 020
4241 L2	0 986 487 701	4246 E8	0 986 478 140	4246 T8	0 986 478 980	4247 31	0 986 477 114
4241 L4	0 986 487 346	4246 F0	0 986 479 239	4246 T9	0 986 478 834	4247 32	0 986 477 070
4241 L7	0 986 487 690	4246 F1	0 986 478 556	4246 V0	0 986 478 834	4247 32	0 986 477 113
4241 L9	0 986 487 712	4246 F4	0 986 478 125	4246 V1	0 986 479 024	4247 33	0 986 477 066
4241 N0	0 986 487 712	4246 F6	0 986 478 125	4246 V3	0 986 478 834	4247 33	0 986 477 118
4241 N2	0 986 487 665	4246 F8	0 986 478 246	4246 V4	0 986 478 732	4247 35	0 986 477 116
4241 N2	0 986 487 695	4246 G0	0 986 478 246	4246 V5	0 986 479 027	4247 37	0 986 477 144
4241 N3	0 986 487 721	4246 G1	0 986 478 834	4246 V7	0 986 478 733	4247 38	0 986 477 098
4241 N4	0 986 487 522	4246 G6	0 986 478 464	4246 W1	0 986 478 618	4247 40	0 986 477 126
4241 N5	0 986 487 726	4246 G9	0 986 478 359	4246 W2	0 986 478 979	4247 41	0 986 477 124
4241 N6	0 986 487 739	4246 H0	0 986 478 371	4246 W3	0 986 478 980	4247 42	0 986 477 066
4241 N8	0 986 487 729	4246 H1	0 986 478 092	4246 W4	0 986 478 981	4247 42	0 986 477 118
4241 P0	0 986 487 702	4246 H2	0 986 478 094	4246 W5	0 986 478 268	4247 43	0 986 477 066
4241 01	0 986 487 341	4246 H3	0 986 478 234	4246 W6	0 986 478 268	4247 43	0 986 477 118
4241 15	0 986 487 076	4246 H5	0 986 478 556	4246 W7	0 986 478 618	4247 44	0 986 477 116
4241 19	0 986 487 089	4246 H8	0 986 478 896	4246 W8	0 986 478 979	4247 45	0 986 477 124
4241 25	0 986 487 084	4246 H9	0 986 478 896	4246 W9	0 986 478 608	4247 46	0 986 477 151
4241 43	0 986 487 275	4246 J0	0 986 479 239	4246 X8	0 986 478 608	4247 47	0 986 477 124
4241 49	0 986 487 020	4246 J2	0 986 478 812	4246 X9	0 986 479 297	4247 48	0 986 477 148
4241 50	0 986 487 426	4246 J3	0 986 478 812	4246 Y1	0 986 479 297	4247 49	0 986 477 124
4241 51	0 986 487 403	4246 J5	0 986 478 435	4246 Y3	0 986 478 842	4249 14	0 986 479 311
4241 52	0 986 487 341	4246 J6	0 986 478 435	4246 Y7	0 986 479 065	4249 15	0 986 478 618
4241 55	0 986 487 243	4246 J8	0 986 478 843	4246 Y9	0 986 479 065	4249 16	0 986 478 618
4241 56	0 986 487 076	4246 J9	0 986 478 843	4246 Z1	0 986 479 066	4249 17	0 986 478 979
4241 57	0 986 487 275	4246 K2	0 986 478 842	4246 Z3	0 986 479 066	4249 18	0 986 478 979
4241 71	0 986 487 084	4246 K3	0 986 478 842	4246 Z7	0 986 479 168	4249 19	0 986 479 255
4241 72	0 986 487 533	4246 K9	0 986 478 556	4246 Z8	0 986 479 168	4249 19	0 986 479 275
4241 73	0 986 487 274	4246 L0	0 986 478 125	4246 Z9	0 986 479 219	4249 20	0 986 479 266
4241 79	0 986 487 383	4246 L2	0 986 478 434	4246 Z9	0 986 479 279	4249 22	0 986 479 379
4241 91	0 986 487 076	4246 L3	0 986 478 434	4246 61	0 986 478 092	4249 23	0 986 479 379
4241 93	0 986 487 081	4246 L6	0 986 478 879	4246 63	0 986 478 051	4249 24	0 986 479 380
4241 94	0 986 487 541	4246 L7	0 986 478 877	4246 69	0 986 478 770	4249 25	0 986 479 380
4241 97	0 986 487 456	4246 L8	0 986 478 831	4246 70	0 986 478 094	4249 26	0 986 479 297
4241 98	0 986 487 441	4246 L9	0 986 478 830	4246 78	0 986 478 089	4249 27	0 986 479 297
4241 99	0 986 487 020	4246 N0	0 986 478 831	4246 83	0 986 478 052	4249 27	0 986 479 312
4242 A1	0 986 487 499	4246 P1	0 986 479 114	4246 84	0 986 478 091	4249 28	0 986 479 313
4246 A0	0 986 478 234	4246 P2	0 986 479 114	4246 85	0 986 478 067	4249 29	0 986 479 313
4246 A1	0 986 478 359	4246 P3	0 986 479 064	4246 88	0 986 478 090	4249 30	0 986 479 399
4246 A2	0 986 478 359	4246 P4	0 986 479 064	4246 89	0 986 478 046	4249 31	0 986 479 399
4246 A4	0 986 478 051	4246 P5	0 986 479 288	4246 90	0 986 478 211	4249 32	0 986 479 255



◀ CITROEN

4249 32	0 986 479 275
4249 33	0 986 479 288
4249 35	0 986 479 314
4249 36	0 986 479 314
4249 37	0 986 479 315

4249 38	0 986 479 315
4249 39	0 986 479 316
4249 40	0 986 479 316
4249 41	0 986 479 317
4249 42	0 986 479 317

4249 44	0 986 479 192
4249 45	0 986 479 383
4249 46	0 986 479 383
4249 46	0 986 479 387
4249 52	0 986 478 608

4249 54	0 986 479 239
4249 61	0 986 479 318
4249 62	0 986 479 318
4249 64	0 986 479 376
4249 65	0 986 479 388

4249 66	0 986 479 388
4249 73	0 986 478 639
4249 74	0 986 478 639
4249 76	0 986 478 810
4249 79	0 986 479 168

4253 23	0 986 424 825
4253 25	0 986 494 099
4253 28	0 986 494 065
4253 44	0 986 424 825
4253 56	0 986 494 111

4253 58	0 986 494 111
4253 60	0 986 494 110
4253 63	0 986 494 163
4253 64	0 986 494 163
4253 65	0 986 494 163

4253 66	0 986 494 163
4253 67	0 986 494 192
4253 68	0 986 494 192
4253 74	0 986 494 109
4253 76	0 986 494 109

4253 91	0 986 424 814
4253 93	0 986 494 261
4253 98	0 986 494 099
4254 04	0 986 494 095
4254 05	0 986 494 127

4254 07	0 986 494 113
4254 11	0 986 494 098
4254 26	0 986 494 261
4257 9G	0 986 478 121
4308 11	1 987 475 030

4308 30	1 987 475 053
4308 34	1 987 475 100
4308 38	1 987 475 253
4308 40	1 987 475 220
4308 45	1 987 475 051

4308 50	1 987 475 214
4308 52	1 987 475 116
4308 53	1 987 475 205
4308 54	1 987 475 241
4308 55	1 987 475 257

4308 56	1 987 475 251
4308 57	1 987 475 253
4308 58	1 987 475 256
4308 59	1 987 475 255
4308 61	1 987 475 255

4308 63	1 987 475 283
4308 64	1 987 475 319
4308 69	1 987 475 304
4308 70	1 987 475 295
4310 16	1 987 475 020

4315 13	1 987 475 173
4315 14	1 987 475 100
4427 55	1 987 474 197
4427 59	1 987 474 198
4427 63	0 204 104 019

4427 64	1 987 474 196
4427 65	1 987 474 194
4427 65	1 987 474 214
4427 66	1 987 474 028
4427 75	1 987 474 199

4427 94	1 987 474 028
4 449 694	0 986 477 031
5 416 277	0 986 478 761
5 416 277 B	0 986 478 761
5 426 184	0 986 478 741

5 429 669 S	0 986 478 218
5 448 826	0 986 478 231
5 448 826 V	0 986 478 231
5 489 362	0 986 478 232
5 489 362 D	0 986 478 232

5 501 420	0 986 487 319
7 531 819	0 986 478 200
75 485 825	0 986 478 052
75 517 323	0 986 487 089
75 521 559	0 986 487 020

75 529 364	0 986 478 218
75 529 970	1 987 475 053
75 684 40	0 986 478 200
75 685 01	0 986 478 067
78 51 531 000	0 986 478 091

79 10 007 378	0 986 478 092
79 10 007 463	0 986 478 051
79 40 708 938	0 986 478 091
91 502 484	0 986 477 097
91 502 484	0 986 477 108

91 508 338	0 986 478 046
91 509 908	0 986 477 060
91 517 694	0 986 478 211
91 517 695	0 986 478 370
93 500 521	0 986 478 234

94 04 241 998	0 986 487 020
94 04 308 348	1 987 475 100
94 04 308 508	1 987 475 214
94 78 267 980	0 986 477 070
95 027 199	0 986 478 246

95 030 547	0 986 478 141
95 563 153	0 986 478 231
95 575 080	0 986 478 090
95 577 775	0 986 487 081
95 582 061	0 986 478 749

95 582 062	0 986 478 749
95 599 322	0 986 478 050
95 609 802	0 986 487 382
95 609 806	0 986 487 081
95 614 553	1 987 475 030

95 618 234	0 986 487 322
95 619 206	0 986 477 066
95 619 206	0 986 477 118
95 619 515	0 986 487 252
95 619 516	1 987 475 220

95 625 020	0 986 487 336
95 632 048	0 986 478 268
95 637 178	0 986 477 020
95 637 178	0 986 477 114
95 637 322	0 986 478 140

95 638 635	0 986 478 750
95 643 713	0 986 487 128
95 643 714	0 986 487 313
95 651 053	1 987 474 198
95 653 213	0 986 487 252

95 655 344	0 986 487 252
95 658 571	1 987 475 205
95 659 470	0 986 487 346
95 659 622	0 986 477 116
95 659 661	0 986 487 289

95 659 662	1 987 475 101
95 659 671	0 986 487 274
95 659 676	0 986 487 533
95 659 717	0 204 104 019
95 661 747	0 986 478 370

95 661 748	0 986 478 046
95 661 749	0 986 478 464
95 661 796	0 986 478 840
95 661 810	0 986 478 246
95 661 811	0 986 478 142

95 661 812	0 986 478 140
95 661 813	0 986 478 125
95 661 814	0 986 478 141
95 661 848	0 986 478 750
95 661 849	0 986 478 749

95 661 850	0 986 478 232
95 663 080	0 986 487 322
95 667 809	0 986 478 268
95 667 810	0 986 478 834
95 667 811	0 986 478 604

95 667 820	0 204 104 021
95 667 820	1 987 474 199
95 669 226	0 986 478 751
96 012 770	0 986 478 464
96 017 878	0 986 478 751

96 047 276	0 986 478 142
96 054 779	0 986 478 140
96 070 525	0 986 478 046
96 099 616	0 986 478 125

DACIA	
60 01 547 683	0 986 479 164
60 01 547 684	0 986 479 165
60 01 549 803	0 986 494 197

84 55 458 161	0 986 487 319
84 55 458 172	0 986 487 541
84 55 499 157	0 986 487 541

DAIHATSU	
04465 B2040	0 986 494 134
04465 B2050	0 986 494 134
04491 97214	0 986 494 134

04491 97214 000	0 986 494 134
04494 87602 000	0 986 487 384
04495 B2180	0 986 487 733
04495 B2220	0 986 487 733
04495 B4050	0 986 487 735

04495 12010 000	0 986 487 025
04495 14010 000	0 986 487 294
04495 87203 000	0 986 487 504
04495 87214 000	0 986 487 504
04495 87401 000	0 986 487 595

04495 87502	0 986 487 393
04495 87503	0 986 487 393
04495 87504	0 986 487 393
04495 87601 000	0 986 487 384
04495 87608 000	0 986 487 384

04495 87703 000	0 986 487 339
04495 87704 000	0 986 487 307
04495 87706 000	0 986 487 307
04495 87707 000	0 986 487 436
04495 87708 000	0 986 487 436

04495 87709 000	0 986 487 339
04495 87711 000	0 986 487 307
04495 87712 000	0 986 487 307
04495 97205 000	0 986 487 742
04495 97206 000	0 986 487 689

04495 97208 000	0 986 487 689
04495 97213 000	0 986 487 689
43512 12110 000	0 986 478 180
43512 12140 000	0 986 478 661
43512 87101 000	0 986 478 661

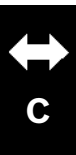

43512 87210 000	0 986 478 754
43512 87215 000	0 986 478 338
43512 87221 000	0 986 478 338
43512 87402	0 986 479 432
43512 87402 000	0 986 478 415

43512 87509	0 986 478 755
43512 87509 000	0 986 478 338
43512 87603 000	0 986 479 487
43512 87607 000	0 986 479 487
43512 87703 000	0 986 478 335

43512 87704 000	0 986 478 335
43512 87709 000	0 986 478 500
43512 87710 000	0 986 478 684
43512 87718 000	0 986 478 684
43512 87722 000	0 986 478 500

43512 87723 000	0 986 478 684
43512 87725 000	0 986 478 684
43512 97202	0 986 479 352
43512 97202 000	0 986 479 352
43512 97204 000	0 986 479 119

43512 97207 000	0 986 479 119
45251 S50 000	0 986 478 415
45251 S1A G60	0 986 478 415
47420 87503 000	0 986 487 501
47420 87504	0 986 487 501

47430 87201	0 986 487 393
47440 87501	0 986 487 393

FIAT

ZF04449694	0 986 477 031
11 646 220 1402 00	0 986 478 760
1300500080	0 986 478 843

1300501080	0 986 478 434
1306211080	0 986 477 098
1307356080	0 986 478 842
1309392080	0 986 478 812
1311823080	0 986 477 144

1313675080	0 986 477 031
1316323080	0 986 478 896
1317651080	0 986 478 812
1325772080	0 986 479 114
1331301080	0 986 479 114

1471288080	0 986 477 144
1489738080	0 986 479 168
164062610001	0 986 478 341
1641022023	0 986 478 521
164202610001	0 986 478 238

16500253	0 986 478 063
1904528	0 986 478 647
1904529	0 986 478 742
1904531	0 986 478 649
1908772	0 986 478 885

1908773	0 986 478 886
4139010	0 986 478 063
4162186	0 986 487 030
4208311	0 986 478 063
424685	0 986 478 067

4340810	0 986 487 271
4340811	0 986 487 271
4377102	0 986 478 740
4379680	0 986 477 055
4385812	0 986 478 063

4448411	0 986 478 066
4449694	0 986 477 031
4450931	0 986 478 067
46401356	0 986 478 639
46403088	0 986 478 810

46403958	0 986 478 786
46403959	0 986 478 810
46403960	0 986 478 342
46416712	0 986 478 515
46419204	0 986 478 878

46423415	0 986 478 515
46427947	0 986 478 786
46427949	0 986 478 786
46445004	0 986 478 810
46445005	0 986 478 512

46445006	0 986 478 521
46448168	0 986 478 810
46448407	0 986 477 125
46449389	0 986 478 993
46449390	0 986 478 460

46455892	0 986 478 810
46465088	0 986 478 703
46469907	0 986 479 100
46469908	0 986 479 120
46479532	0 986 478 703

46535086	0 986 478 855
46542383	0 986 478 639
46542702	0 986 479 120
46737998	0 986 478 677
46758714	0 986 478 810

46758715	0 986 478 238
46763837	0 986 478 677
46765546	0 986 478 855
46776750	0 986 478 963
46788929	0 986 479 121

46806233	0 986 479 297
46806234	0 986 478 842
46819776	0 986 477 083
46820655	0 986 478 343
46831041	0 986 478 639

46831042	0 986 478 238
46833806	0 986 479 065
46833806	0 986 479 298
46833807	0 986 479 066
46836489	0 986 479 106

46836490	0 986 479 142
46843608	0 986 479 293
46843610	0 986 479 378
46843611	0 986 479 326
46844071	0 986 479 107

51705749	0 986 479 313
51705758	0 986 479 315
51728377	0 986 479 297
51728378	0 986 479 314
51731346	0 986 479 324

51740244	0 986 479 297
51740245	0 986 479 399
51740246	0 986 479 313
51740247	0 986 479 314
51740248	0 986 479 066

51740249	0 986 479 315
51740250	0 986 479 317
51742727	0 986 479 121
51749124	0 986 478 515
51749274	0 986 479 399

51749275	0 986 479 316
51749555	0 986 479 317
51757229	0 986 479 325
51760273	0 986 479 378
51760274	0 986 479 326

51760621	0 986 479 293
51760622	0 986 479 324
51767377	0 986 479 292
51767378	0 986 479 292
51767379	0 986 479 327

51767380	0 986 479 327
51767381	0 986 479 291
51767382	0 986 479 291
51767383	0 986 479 290
51767384	0 986 479 290

51767384	0 986 479 324
51806099	0 986 479 402
5416277	0 986 478 761
5416277 B	0 986 478 761
55700592	0 986 479 222

55700593	0 986 479 222
55700920	0 986 479 223
55700921	0 986 479 223
55700922	0 986 479 224
55700923	0 986 479 224

5880891	0 986 487 030
5880992	0 986 487 421
5881040	0 986 487 030
5881050	0 986 487 030
5881159	0 986 487 285

5881159	0 986 487 374
5881214	0 986 487 030
5881964	0 986 487 030
5888144	0 986 487 030
5888433	0 986 487 250

5888453	0 986 487 255
5890500	0 986 487 250
5961814	0 986 478 353
5974792	0 986 477 055
5975061	0 986 477 055

60501453	0 986 478 212
60522092	0 986 478 760
60526087	0 986 478 736
60533971	0 986 478 739
60551775	0 986 478 521

60569163	0 986 478 521
60569164	0 986 478 341
60569386	0 986 478 521
60571548	0 986 478 521
60576335	0 986 478 342

60578920	0 986 478 444
60617106	0 986 478 668
60621051	0 986 478 107
60622077	0 986 478 521
60629865	0 986 478 669

60651437	0 986 478 444
60652186	0 986 478 711
60653478	0 986 478 521
60653479	0 986 478 341
60653487	0 986 478 668

60658565	0 986 478 521
60658566	0 986 478 341
60658567	0 986 478 668
60670801	0 986 478 711
60670804	0 986 478 444

60703319	0 986 487 295
60749883	0 986 487 546
60750466	0 986 487 295
60750467	0 986 487 546
60750472	0 986 487 295

60750871	0 986 487 295
60801722	0 986 478 521
60801751	0 986 478 512
60801755	0 986 478 238
60801786	0 986 478 341

60801787	0 986 478 341
60805117	0 986 478 342
60806135	0 986 478 810
60806137	0 986 478 515
60807625	0 986 478 512

60808872	0 986 478 343
60810038	0 986 487 255
60810076	0 986 478 515
60811256	0 986 478 515
60811266	0 986 478 515

60811879	0 986 478 342
60811890	0 986 478 786
60812067	0 986 478 786
60812137	0 986 478 639
60812422	0 986 478 810



◀ FIAT

60812685	0 986 478 512
60813016	0 986 477 109
60813038	0 986 478 810
60814639	0 986 478 460
60814646	0 986 478 463

60814921	0 986 478 669
60815938	0 986 478 521
7074668	0 986 487 030
7078585	0 986 487 630
7081572	0 986 487 630

7081832	0 986 487 629
7082149	0 986 487 626
71711434	0 986 478 521
71711447	0 986 478 521
71738377	0 986 487 331

71738905	0 986 479 297
71739571	0 986 478 444
71742832	0 986 487 731
71742850	0 986 479 403
71742853	0 986 494 129

71747587	0 986 487 731
7180256	0 986 478 886
7531819	0 986 478 200
7538682	0 986 478 234
7545556	0 986 478 343

7550923	0 986 478 235
7566931	0 986 478 342
7568440	0 986 478 200
7568501	0 986 478 067
7569600	0 986 477 088

7599325	0 986 477 083
7645054	0 986 478 342
7645055	0 986 478 343
7645056	0 986 478 515
7650707	0 986 478 235

7663465	0 986 478 342
7663466	0 986 478 343
7685656	0 986 478 342
77362284	0 986 487 559
77362286	0 986 487 701

77362290	0 986 487 712
77362291	0 986 487 331
77362292	0 986 487 030
77362293	0 986 487 331
77362295	0 986 487 597

77362296	0 986 487 596
77362365	0 986 487 690
77362449	0 986 487 670
77362453	0 986 487 626
77362454	0 986 487 630

77362491	0 986 487 669
77362611	1 987 475 162
77362615	0 986 487 704
77362722	0 986 494 067
77362756	0 986 487 629

77362929	0 986 487 716
77363336	0 986 494 069
77363478	0 986 487 712
77363479	0 986 487 712
77363599	0 986 494 071

77363607	0 986 494 125
77363610	0 986 494 126
77363627	0 986 494 068
77363855	0 986 487 702
77363858	0 986 487 703

77363946	0 986 487 717
77363959	0 986 494 072
77363959	0 986 494 222
77363992	0 986 494 132
77364014	0 986 494 111

77364015	0 986 494 109
77364016	0 986 494 110
77364023	0 986 487 726
77364029	0 986 487 702
77364160	0 986 494 111

77364161	0 986 494 109
77364168	0 986 494 124
77364169	0 986 494 124
77364224	0 986 494 073
77364264	0 986 487 703

77364281	0 986 494 074
77364318	0 986 494 109
77364319	0 986 494 109
77364331	0 986 494 075
77364332	0 986 494 075

77364394	0 986 494 070
77364473	0 986 494 132
77364511	0 986 494 163
77364513	0 986 494 192
77364516	0 986 494 131

77364587	0 986 494 071
77364635	0 986 494 115
77364636	0 986 494 114
77364637	0 986 494 113
77364667	0 986 487 729

77364919	0 986 494 132
7750119	0 986 477 083
7769850	0 986 477 088
7774593	0 986 477 109
7777842	0 986 477 055

7779409	0 986 478 515
7789267	0 986 478 341
82286142	0 986 478 354
82346805	0 986 478 354
82387932	0 986 478 236

823885	0 986 478 237
82388579	0 986 478 237
82394417	0 986 478 238
82394418	0 986 478 238
82418684	0 986 478 341

82427592	0 986 478 521
82433789	0 986 478 512
82433857	0 986 478 236
82433858	0 986 478 237
82433859	0 986 478 238

82433860	0 986 478 237
82433918	0 986 478 810
82434070	0 986 478 238
82434169	0 986 478 517
82439939	0 986 478 341

82440275	0 986 478 341
82440356	0 986 478 810
82450539	0 986 478 521
82450657	0 986 478 810
82451441	0 986 478 512

82451746	0 986 478 810
82451747	0 986 478 512
82462136	0 986 478 786
82464702	0 986 478 237
82480447	0 986 478 460

82487489	0 986 478 993
82488240	0 986 478 463
8482290	0 986 478 647
8582290	0 986 478 647
85822901	0 986 478 647

8584182	0 986 478 649
92498609	0 986 478 343
93500520	0 986 478 200
93500521	0 986 478 234
93800492	0 986 478 742

93821918	0 986 478 885
9464222687	0 986 479 064
9464640587	0 986 479 168
9467548487	0 986 479 379
9467548587	0 986 479 380

9467548887	0 986 494 163
9467548987	0 986 494 163
9467549087	0 986 494 192
9 566 926 980	0 986 487 606
9566928380	0 986 478 435

9566949580	0 986 487 545
9569692680	0 986 487 545
98601861	0 986 477 125
98845054	0 986 487 626
9939718	0 986 487 128

9940559	0 986 487 128
9941210	0 986 487 313
9941243	0 986 487 128
9943934	0 986 487 128
9943935	0 986 487 313

9945371	0 986 487 331
9945640	0 986 487 331
9945884	0 986 487 522
9945885	0 986 487 521
9945975	0 986 487 317

9945976	1 987 475 219
9945981	1 987 475 219
9946560	0 986 487 128
9946561	0 986 487 313
9947106	0 986 487 295

9947372	1 987 474 241
9947690	0 986 487 560
9947773	0 986 487 317
9947939	0 986 487 559
9948200	0 986 487 250

9948235	0 986 487 030
9948240	0 986 487 030
9948372	0 986 487 597
9948373	0 986 487 596
9949490	0 986 487 701

9949494	0 986 487 712
9950814	0 986 487 295

FORD

DBRZ 1125 A	0 986 478 068
DORY 1125 A	0 986 478 072
D85GB 2M008 AG	0 986 469 820

D92GB 2M008 AA	0 986 469 820
E646460 S71M	0 986 478 069
E7RY 1125 C	0 986 478 346
E92Z 1125A	0 986 478 523
E92Z 2C026A	0 986 478 700

F32Z 1125 A	0 986 478 227
F32Z 2C026 A	0 986 478 633
F5RZ 1125 A	0 986 478 170
F5RZ 1125 B	0 986 478 170
F5RZ 2C026 A	0 986 478 605

GJ25 26 251	0 986 478 700
GJ25 26 251A	0 986 478 700
GJ25 26 251B	0 986 478 700
GJ55 26 251	0 986 478 700
GJ55 26 251A	0 986 478 700

GJ55 26 251B	0 986 478 700
RA76SX 2L362 AA	0 986 487 032
RV82F B2200 AA	0 986 487 032
V82FX 1125 AA	0 986 478 069
V84FB 2200 AB	0 986 487 195

V84FX 1125 AB	0 986 478 069
V85BX 1125 AC	0 986 478 096
V85BX 2A315 AB	0 986 478 344
V86AB 2200 AA	0 986 487 409
V86BX 2A315 AA	0 986 478 815

V88BX 1125 AA	0 986 478 814
V89BX 1125 AC	0 986 478 670
V89BX 1125 BA	0 986 478 822
V89BX 2A315 AA	0 986 478 816
W303142-	0 986 478 077



W303143-	0 986 478 078
W303144-	0 986 478 078
XS6C1126AA	0 204 072 818
YC1J 2200 AA	0 986 487 612
YC1W 1125 BA	0 986 478 303
YC15 2200 AA	0 986 487 612
YC15 2200 AC	0 986 487 612
YC15 2200 AD	0 986 487 612
YC15 2200 AE	0 986 487 612
YL842 L362 AD	0 986 487 654
YM21 1125 AA	0 986 478 296
YM21 1125 BA	0 986 479 037
YM21 2A315 AB	0 986 478 569
YS5J 2200-AA	0 986 487 624
YS51 2A225-AA	1 987 475 219
YS51 2200-AB	0 986 487 624
YS6J 2200-AA	0 986 487 599
YS6W 1113 AA	0 986 477 099
YS6W 1125-AA	0 986 478 502
YS6W 1125-AC	0 986 478 502
YS6W 1125-B1B	0 986 478 502
YS6W 1125-CA	0 986 478 502
YS6W 1125-CB	0 986 478 502
YS61 2A225-AB	1 987 475 274
YS61 2200-AB	0 986 487 599
YS61 2200-AC	0 986 487 599
YS8J 2C502 AA	0 986 478 227
YS8J 2C502 BA	0 986 478 633
1C1W 1125 AA	0 986 478 299
1C15 2200 AC	0 986 487 660
1M5W 1113 AA	0 986 477 102
1S7W 1125 AB	0 986 478 718
1S7W 1125 AC	0 986 478 718
1S7W 1125 B3B	0 986 478 718
1S7W 1125 B3D	0 986 478 718
1S7W 1125 CA	0 986 478 718
1S7W 1125 CB	0 986 478 718
1S7W 2A315 AD	0 986 479 068
1S7W 2A315 B3E	0 986 479 068
1S7W 2A315 CA	0 986 479 068
1S7W 2A315 CB	0 986 479 068
1000859	0 986 477 099
1001093	0 986 478 893
1001094	0 986 478 421
1005960	0 986 487 553
1005968	0 986 487 561
1005970	0 986 487 553
1006004	1 987 475 221
1006005	1 987 475 057
1013581	0 986 478 856
1014317	0 986 487 525
1014655	0 986 487 523
1017668	0 986 477 099
1019604	0 986 478 502
1023605	0 986 478 421

1025911	0 986 478 605
1027371	0 986 477 051
1041906	0 986 487 561
1041909	0 986 487 674
1042858	1 987 474 098
1045392	0 986 477 044
1045994	0 986 478 893
1045995	0 986 478 421
1059500	0 986 487 553
1060096	0 986 487 561
1060102	0 986 487 674
1065033	0 986 487 561
1065036	0 986 487 674
1066271	0 986 478 502
1073756	0 986 478 344
1075549	0 986 487 633
1075555	1 987 475 262
1086922	1 987 475 057
1104128	0 986 487 553
1106633	0 986 487 599
1107767	0 986 478 501
1107768	0 986 478 502
1108038	0 986 478 296
1111283	0 986 469 820
1111843	1 987 475 219
1112542	0 986 478 856
1121669	0 986 487 633
1123789	0 986 487 624
1123790	0 986 487 599
1123794	1 987 475 274
1125669	0 986 487 599
1126158	0 986 487 633
1135082	0 986 487 624
1135083	0 986 487 599
1140278	0 986 478 569
1141782	0 986 479 037
1143641	0 986 478 893
1145292	0 986 487 599
1145298	1 987 475 274
1148202	0 986 478 892
1158208	0 986 478 074
1197674	0 986 487 599
1213352	0 986 477 149
1223540	0 986 479 169
1223568	0 986 479 170
1223663	0 986 479 173
1223664	0 986 479 171
1223665	0 986 479 173
1223666	0 986 479 171
1227045	0 986 487 660
1227046	0 986 487 612
1233679	0 986 494 127
1236882	0 986 487 599
1253728	0 986 479 169
1253962	0 986 479 170

1253965	0 986 479 171
1315740	0 986 477 149
1320352	0 986 479 173
1320581	0 986 478 502
1320582	0 986 478 502
1320585	0 986 478 892
1321488	0 986 478 718
1323102	0 986 479 068
1323551	0 986 479 170
1323560	0 986 479 171
1323620	0 986 478 892
1323621	0 986 478 344
1334973	0 986 477 129
1334975	0 986 477 129
1347420	0 986 487 696
1360254	0 986 494 127
1360306	0 986 494 127
1361298	0 986 479 069
1361300	0 986 479 069
1361302	0 986 477 129
1361304	0 986 477 129
1362867	0 986 479 070
1368548	0 986 479 310
1368558	0 986 494 077
1371393	0 986 479 307
1371394	0 986 479 392
1371402	0 986 494 170
1371420	0 986 479 390
1371454	0 986 494 171
1373289	0 986 478 502
1373360	0 986 479 169
1373369	0 986 479 173
1373370	0 986 479 171
1373771	0 986 478 892
1376118	0 986 478 718
1376138	0 986 479 068
1379931	0 986 479 254
1379965	0 986 479 261
1379971	0 986 494 169
1384290	0 986 479 310
1385590	0 986 479 254
1385735	0 986 487 696
1387152	0 986 479 389
1388257	0 986 478 718
1405500	0 986 479 254
1405510	0 986 479 261
1416191	0 986 477 149
1420600	0 986 479 261
1420601	0 986 479 261
1427965	0 986 477 085
1433952	0 986 494 170
1433958	0 986 494 171
1437761	0 986 494 169
1451161	0 986 479 389
1458247	0 986 494 169

1464031	0 986 479 390
1469082	0 986 479 173
1473814	0 986 478 071
1484495	0 986 487 371
1488519	0 986 487 402
1488962	0 986 494 170
1490767	0 986 477 014
1495146	0 986 477 084
1500158	0 986 479 261
1500159	0 986 479 261
1503287	0 986 479 307
1503290	0 986 479 392
1507939	0 986 487 147
1517696	0 986 479 261
1520033	0 986 487 510
1522208	0 986 478 077
1522209	0 986 478 078
1522611	0 986 477 028
1530602	0 986 494 171
1531939	0 986 487 140
1539262	0 986 487 280
1539549	0 986 478 190
1545199	0 986 477 085
1548324	0 986 487 232
1549659	0 986 478 071
1549699	0 986 478 071
1549700	0 986 478 077
1549701	0 986 478 077
1549702	0 986 478 078
1549703	0 986 478 078
1555151	0 986 487 397
1555152	0 986 487 475
1556044	0 986 487 308
1564842	0 986 478 191
1569039	0 986 487 032
1569699	0 986 478 071
1571346	0 986 478 068
1571347	0 986 478 068
1571348	0 986 478 068
1571575	0 986 487 420
1571576	0 986 487 340
1575877	0 986 478 068
1583835	0 986 478 077
1583926	0 986 478 078
1591135	0 986 487 146
1591990	0 986 478 068
1591991	0 986 478 068
1591996	0 986 478 071
1595768	0 986 487 475
1595875	0 986 478 148
1598117	0 986 477 015
1604636	0 986 478 069
1613131	0 986 487 133
1619053	0 986 478 148
1619054	0 986 478 148



◀ FORD

1619135	0 986 487 195	2T14 1125-EC	0 986 479 069	4143445	0 986 479 068	5022668	0 986 478 195
1619136	0 986 487 195	2T14 1126 CA	0 986 477 129	4146389	0 986 478 227	5022669	0 986 478 196
1619173	0 986 478 074	2T14 1126 CB	0 986 477 129	4146391	0 986 478 633	5022674	0 986 478 190
1619174	0 986 478 074	2T14 1126 CC	0 986 477 129	4176921	0 986 479 068	5022675	0 986 478 191
1619208	0 986 478 069	2T14 1126 CD	0 986 477 129	4179398	0 986 478 718	5022676	0 986 478 345
1624857	0 986 478 072	2T14 1126 DA	0 986 477 129	4179406	0 986 479 068	5022677	0 986 478 190
1625131	0 986 487 195	2T14 1126 DB	0 986 477 129	4181042	0 986 478 718	5022829	0 986 478 071
1629450	0 986 478 068	2T14 1126 DC	0 986 477 129	4186874	0 986 477 102	5022947	0 986 478 072
1629451	0 986 478 068	2T14 1126 DD	0 986 477 129	4367102	0 986 477 129	5022949	0 986 478 196
1629475	0 986 478 072	2T142 A315 AB	0 986 479 070	4367103	0 986 477 129	5023441	0 986 478 195
1629477	0 986 478 072	2T142 A315 AC	0 986 479 070	4387344	0 986 487 667	5023444	0 986 478 195
1629478	0 986 478 074	2T14 2200-AA	0 986 487 667	4410264	0 986 479 048	5023482	0 986 478 814
1629479	0 986 478 346	3L54 1102 CA	0 204 002 936	4411312	0 986 479 049	5023483	0 986 478 344
1629480	0 986 478 148	3M5J2 M008 AA	0 986 494 127	4438930	0 986 487 654	5023573	0 986 478 148
1629482	0 986 478 148	3M512 A315 AB	0 986 479 169	4455980	0 986 479 069	5024174	0 986 478 670
1630011	0 986 478 666	3M512 A315 AE	0 986 479 169	4455981	0 986 477 129	5024175	0 986 478 816
1630012	0 986 478 196	3M512 A315 EA	0 986 479 170	4455986	0 986 487 612	5024374	0 986 478 155
1630149	0 986 478 344	3M512 A315 EC	0 986 479 170	4457985	0 986 479 069	5024744	0 986 478 072
1637534	0 986 478 815	3M512 C375 AA	0 986 479 173	4457989	0 986 479 070	5024745	0 986 478 074
1637618	0 986 478 814	3M512 C375 AC	0 986 479 173	4467600	0 986 477 129	5025610	0 986 478 160
1637968	0 986 478 069	3M512 C375 AD	0 986 479 173	4525732	0 986 487 612	5025611	0 986 478 166
1637969	0 986 478 344	3M512 C375-A1D	0 986 479 173	4540440	1 987 475 284	5025950	0 986 478 671
1638304	0 986 487 409	3M512 C375 BA	0 986 479 171	4540771	0 986 487 660	5025951	0 986 478 672
1638879	0 986 478 096	3M512 C375 BC	0 986 479 171	4743576	0 986 487 612	5026674	0 986 478 822
1643706	0 986 478 346	3M512 C375 BD	0 986 479 171	5002996	0 986 487 032	5026784	0 986 478 170
1644205	0 986 478 072	3M512 C375-CB	0 986 479 310	5010950	0 986 487 032	5026785	0 986 478 427
1644831	0 986 478 096	3M512 C375 DA	0 986 479 173	5015666	0 986 487 540	5026786	0 986 478 605
1644844	0 986 478 148	3M512 C375 EA	0 986 479 171	5016219	0 986 487 032	5027462	0 986 478 195
1644845	0 986 478 148	3M512 M008 AC	0 986 494 127	5018535	1 987 475 036	5027463	0 986 478 195
1644857	0 986 478 072	3M51 2200-BA	0 986 487 696	5020413	0 986 487 035	5027464	0 986 478 196
1648631	0 986 487 195	3M51 2200-BB	0 986 487 696	5020560	0 986 487 304	5027751	0 986 487 240
1648717	0 986 478 814	3M51 7540-A2H	0 986 478 071	5020561	0 986 487 032	5027752	0 986 487 537
1659810	0 986 478 344	3049844	0 986 477 102	5020562	0 986 487 195	5027770	0 986 487 358
1661467	0 986 478 670	3395510	0 986 478 227	5021303	0 986 487 304	5027770	0 986 487 524
1661471	0 986 478 816	3415598	0 986 478 633	5021304	0 986 487 032	5028034	1 987 475 151
1661851	0 986 477 012	3555344	0 986 478 892	5021305	0 986 487 195	5028281	0 986 478 502
1662294	0 986 487 328	3573537	0 986 478 892	5022254	0 986 478 077	5029815	0 986 478 160
1666624	0 986 469 820	3958455	0 986 478 227	5022347	0 986 478 078	5029816	0 986 478 166
1666716	0 986 469 820	4N512 K021 AB	0 986 494 077	5022453	0 986 478 078	5030657	0 986 478 816
1667526	1 987 474 175	4034886	0 986 477 099	5022650	0 986 478 068	5030658	0 986 478 344
1954433	0 986 478 532	4041427	0 986 478 299	5022651	0 986 478 068	6C1T1 3N490 GE	0 986 487 147
1954496	0 986 487 583	4041428	0 986 478 303	5022652	0 986 478 501	6C1T1 3N490 GE	0 986 487 351
1960416	0 986 487 583	4055724	0 986 487 612	5022653	0 986 478 501	6C11 1125-AA	0 986 479 307
2M5V 1125-AB	0 986 479 048	4070864	0 986 478 427	5022654	0 986 478 502	6C11 1125-AB	0 986 479 307
2M5V 2A315 AB	0 986 479 049	4070865	0 986 478 170	5022655	0 986 478 069	6C11 1125 BA	0 986 479 392
2S6J 2200-BA	0 986 487 599	4071714	0 986 478 502	5022656	0 986 478 069	6C11 1125 BB	0 986 479 392
2S61 1113-AH	0 986 477 149	4077455	0 986 478 892	5022658	0 986 478 072	6C112 A315 AA	0 986 479 390
2S61 1113-AJ	0 986 477 149	4083484	0 986 478 344	5022659	0 986 478 148	6C11 2K021 AB	0 986 494 170
2S61 1113-AK	0 986 477 149	4084226	0 986 478 502	5022660	0 986 478 148	6C11 2K021 AC	0 986 494 170
2S61 1125-AA	0 986 478 892	4095038	0 986 487 660	5022662	0 986 478 074	6C11 2K021 AD	0 986 494 170
2S61 2A225-AA	1 987 475 274	4097477	0 986 478 718	5022663	0 986 478 346	6C11 2M008 AB	0 986 494 171
2S61 2200-AA	0 986 487 599	4097478	0 986 478 718	5022664	0 986 478 096	6C11 2M008 AC	0 986 494 171
2T14 1125-CB	0 986 479 069	4110585	0 986 487 660	5022665	0 986 478 814	6C11 2M008 AD	0 986 494 171
2T14 1125-CC	0 986 479 069	4115996	0 986 478 605	5022666	0 986 478 344	6G912 A315 AA	0 986 479 254
2T14 1125-EB	0 986 479 069	4143208	0 986 487 612	5022667	0 986 478 815	6G912 A315 BA	0 986 479 254

6G91 2C375 CB	0 986 479 261
6G91 2C375 FA	0 986 479 261
6G91 2K021-A2C	0 986 494 169
6G91 2K021-A2D	0 986 494 169
6008178	0 986 477 028
6008179	0 986 477 028
6010148	0 986 478 071
6010229	0 986 478 071
6010231	0 986 478 077
6041696	0 986 478 190
6046462	0 986 477 013
6049432	0 986 477 085
6063754	0 986 477 129
6063755	0 986 477 012
6063757	0 986 477 084
6070681	0 986 477 014
6070682	0 986 477 014
6077974	0 986 478 148
6077975	0 986 478 072
6079618	0 986 487 140
6079618	0 986 487 402
6079619	0 986 487 140
6079619	0 986 487 147
6079620	0 986 487 147
6079622	0 986 487 397
6079623	0 986 487 280
6079624	0 986 487 475
6081793	0 986 487 048
6086628	0 986 477 015
6088223	0 986 487 035
6088224	0 986 487 133
6089787	0 986 478 078
6089875	0 986 478 068
6089877	0 986 478 077
6089878	0 986 478 078
6091793	0 986 487 048
6092165	0 986 478 074
6096058	0 986 487 304
6096358	0 986 477 084
6100043	0 986 478 074
6101229	0 986 478 071
6101928	0 986 478 072
6104204	1 987 475 036
6113131	0 986 487 133
6113662	0 986 487 035
6113662	0 986 487 286
6122827	0 986 478 346
6132809	0 986 487 035
6133549	0 986 478 148
6133550	0 986 478 148
6134505	0 986 478 346
6134507	0 986 478 148
6134909	0 986 487 304
6135249	0 986 478 345
6137291	0 986 478 072

6137292	0 986 477 014
6137968	0 986 478 069
6141149	0 986 469 820
6142943	0 986 477 014
6143505	0 986 478 346
6150091	0 986 487 242
6150092	0 986 487 242
6150093	0 986 487 328
6150094	0 986 487 309
6150095	0 986 487 309
6150270	0 986 487 035
6150270	0 986 487 286
6150271	0 986 487 133
6155610	0 986 469 820
6158202	0 986 478 148
6158203	0 986 478 072
6158205	0 986 478 072
6158206	0 986 478 074
6158210	0 986 478 148
6158211	0 986 478 148
6158212	0 986 478 068
6158213	0 986 478 068
6158214	0 986 478 666
6158215	0 986 478 196
6159204	0 986 478 148
6159641	0 986 487 304
6162337	0 986 469 820
6162659	0 986 487 540
6166055	0 986 478 345
6166056	0 986 478 190
6168109	0 986 478 195
6169972	0 986 478 074
6169973	0 986 478 074
6169974	0 986 478 346
6169975	0 986 478 346
6175343	0 986 469 820
6176743	0 986 477 044
6177227	0 986 487 195
6183876	0 986 487 228
6183877	0 986 487 229
6185119	0 986 469 820
6189769	0 986 469 820
6191061	0 986 478 501
6191062	0 986 478 501
6191063	0 986 478 501
6191064	0 986 478 502
6192490	0 986 477 115
6198026	0 986 477 047
6450826	0 986 478 195
6464214	0 986 477 048
6500943	0 986 487 240
6500944	0 986 487 537
6500945	0 986 487 241
6530511	1 987 475 031
6559229	0 986 477 012

6559230	0 986 487 534
6560026	0 986 477 044
6560027	0 986 477 049
6560028	0 986 477 050
6579150	0 986 487 358
6579150	0 986 487 524
6676462	0 986 478 427
6691106	0 986 478 672
6710010	0 986 477 051
6710016	0 986 487 330
6710017	0 986 487 523
6733350	0 986 487 401
6837963	0 986 477 054
6920297	1 987 475 254
6920710	0 986 477 044
6920711	0 986 477 050
6978969	0 986 487 228
7G91 1125 AA	0 986 479 261
7G91 1125 BA	0 986 479 261
7G91 1125-EA	0 986 479 261
7098234	0 986 477 115
7125122	0 986 487 524
7125123	0 986 487 525
7166588	0 986 487 228
7176735	0 986 487 523
7267808	0 986 487 330
7296356	0 986 477 044
73BB 1125 DA	0 986 478 071
76VB 1125 AB	0 986 478 190
76VB 1125 BS	0 986 478 191
76VB 1126 AS	0 986 477 085
77FB 1113 BC	0 986 477 013
77FB1125AB	0 986 478 068
78EB 1126 AA	0 986 477 129
78EB 1126 BA	0 986 477 012
78GB 1126 BA	0 986 477 084
8A61 18D422-BE38QA	0 986 478 068
81AB 1113 AF	0 986 477 015
81AB 1113 AFW	0 986 477 015
81AB 2200 AB	0 986 487 035
8158211	0 986 478 148
83BB 1125 CH	0 986 478 346
83BB 2200 BD	0 986 487 534
84AB 2200 AA	0 986 487 035
84AB 2200 AB	0 986 487 035
84AB 2200 AB	0 986 487 286
84FB 2200 AC	0 986 487 195
84FB 2200 AD	0 986 487 195
84FX 1125 CA	0 986 478 068
85AB 2200 AA	0 986 487 133
85GB 2M008 AG	0 986 469 820
85GX 2A315 AB	0 986 478 196
85GX 2A315 BD	0 986 478 196
85GX 2M008 AG	0 986 469 820
86AB N31021 AB2H	0 986 478 072

86AB 1126 AA	0 986 477 014
86BX 2200 GA	0 986 487 540
86VX 1125 AB	0 986 478 345
86VX 1125 BA	0 986 478 190
87BB 2200 AA	0 986 487 304
87BX 1125 CA	0 986 478 148
87BX 1125 DA	0 986 478 148
88AX 2200 DA	0 986 487 035
88BX 2200 MA	0 986 487 304
88FX 2200 AA	0 986 487 032
88FX 2200 BA	0 986 487 195
88FX 2200 CA	0 986 487 032
88FX 2200 DA	0 986 487 195
88FX 2200 RA	0 986 487 304
89BB 1126 AA	0 986 477 012
89FB 1113 BC	0 986 477 049
89FB 2200 BB	0 986 487 229
89GX 00001125	0 986 478 078
91AB 1113 AD	0 986 477 050
91AB 2200 GA	0 986 487 240
91AB 2200 LA	0 986 487 537
91AB 2200 MA	0 986 487 241
91AX 1125 AB	0 986 478 671
91GX 2A315 AA	0 986 478 155
92AX 2200 AA	0 986 487 240
92AX 2200 BA	0 986 487 537
92VB 1126 AA	0 986 477 048
92VB 1126 BA	0 986 477 047
92VB 2200 BB	0 986 487 401
92VX 2200 AA	0 986 487 358
92VX 2200 AA	0 986 487 524
93BB 1125 D3C	0 986 478 170
93BB 1125 E3C	0 986 478 427
93BB 1126 AB	0 986 477 054
93BB 1126 CA	0 986 477 051
93BB 2A315 C1B	0 986 478 605
93BB 2200 AB	0 986 487 330
93BB 2200 BD	0 986 487 523
93BB 2200 CB	0 986 487 330
93BX 1125 CB	0 986 478 427
93BX 2A315 AD	0 986 478 605
93FB 1126 AA	0 986 477 115
93FX 1125-AA	0 986 478 502
93FX 1125-SA	0 986 478 502
93FX 1125-S1A	0 986 478 502
93GX 1125 AA	0 986 478 195
93GX 1125 BA	0 986 478 195
94FB 2200 AA	0 986 487 228
94VB 2200 AB	0 986 487 524
94VB 2200 BB	0 986 487 525
94VX 2200 BB	0 986 487 525
95AB 2A225-AA	1 987 475 221
95AB 2200 AA	0 986 487 553
95AB 2200 BA	0 986 487 561
95AB 2200 BB	0 986 487 561



◀ FORD

95AB 2200 BC	0 986 487 561
95AX 2200 BB	0 986 487 561
95GB2A315B1C	0 986 478 344
95GB2A315FA	0 986 478 344
95GX 2A315 DA	0 986 478 816

95GX 2A315-EA	0 986 478 344
95VWX 1125 BD	0 986 478 893
95VWX 1125 B1D	0 986 478 893
95VWX 2A315 AD	0 986 478 421
95VX 1125 AA	0 986 478 160

95VX 1125 BA	0 986 478 166
96AB 2200 AB	0 986 487 674
96AB 2200 AC	0 986 487 674
96AX 2200 AB	0 986 487 674
96FB 1113 BB	0 986 477 099

96FB 1113 BC	0 986 477 099
96FB 2200 AA	0 986 487 553
96FB 2200-AC	0 986 487 553
96FX 1125-A1B	0 986 478 856
96FX 1125-CA	0 986 478 502

96FX 2L051-AA	1 987 474 098
96FX 2200-AA	0 986 487 553
97FB 1113 BA	0 986 477 044
98AB 1113 BE	0 986 477 102
98AB1125BD	0 986 478 892

98AB 1125-BE	0 986 478 892
98AB 1125-D1E	0 986 478 892
98AB 2A225-BA	1 987 475 262
98AB 2200 BD	0 986 487 633
98AB 2200 BE	0 986 487 633

98AG 1125-EA	0 986 478 892
98AG 1125-EB	0 986 478 892
98AX 2200 BD	0 986 487 633

GAZ

3110 3501077	0 986 479 347
--------------	----------------------

HONDA

BNP 2488	0 986 478 651
CLP 3757	0 986 478 240
04431 ST3 E00	0 986 487 364

04431 S1AE60	0 986 487 661
04431 S5 SE01	0 986 487 440
06043-634-670	0 986 487 049
06043-671-000	0 986 487 049
064B3 671 000	0 986 487 049

3501 081-JA	0 986 478 018
42510 SCA E50	0 986 479 449
42510-SD4-000	0 986 478 680
42510 SEA E00	0 986 479 450
42510-SE0-000	0 986 478 350

42510-SE0-010	0 986 478 350
42510-SG9-000	0 986 478 752
42510-SG9-000	0 986 479 447
42510-SG9-010	0 986 479 447
42510 SH3 G00	0 986 478 350

42510 SK3 E00	0 986 478 350
42510 SMG E20	0 986 479 451
42510-SM4-950	0 986 478 172
42510 SNA A00	0 986 479 451
42510-SN7-000	0 986 478 172

42510-SP0-000	0 986 479 017
42510 SR3 A10	0 986 479 101
42510 SR3 A11	0 986 479 101
42510 SR3 G00	0 986 479 101
42510 SR3 J00	0 986 479 101

42510-SR3-000	0 986 479 101
42510 SSO J00	0 986 478 680
42510-SS0-000	0 986 478 680
42510 ST3 E00	0 986 479 014
42510 SV1 A00	0 986 478 172

42510 SWW G01	0 986 479 449
42510 SWW G01	0 986 479 452
42510 S5TE00	0 986 479 225
42510 S6D E00	0 986 479 014
42510 S7A J50	0 986 479 361

42610-SB2-010	0 986 477 063
42610-SB2-761	0 986 477 063
42610-SE0-000	0 986 477 081
42610-SR1-000	0 986 477 081
42610-SR3-000	0 986 477 081

42610-S70-000	0 986 477 147
43015-SP8-000	0 986 487 364
43022 SAA E50	0 986 494 128
43053SAAE50	0 986 487 741
43053 SJF E00	0 986 487 686

43053 S47 E50	0 986 487 686
43152-601-004	0 986 487 049
43153-SA0-901	0 986 487 296
43153-SA3-003	0 986 487 385
43153-SA3-013	0 986 487 385

43153-SA5-672	0 986 487 302
43153-SAG-672	0 986 487 302
43153-SB2-602	0 986 487 233
43153 SE0 S01	0 986 487 323
43153-SE0-003	0 986 487 323

43153 SH3 G02	0 986 487 233
43153 SH5 G01	0 986 487 356
43153 SM4 A01	0 986 487 440
43153 SR3 A01	0 986 487 460
43153 SR4 A02	0 986 487 323

43153 ST0J01	0 986 487 323
43153-S09-671	0 986 487 356
43153 S2G951	0 986 487 323
43153-601-004	0 986 487 049
43153-601-006	0 986 487 049

43153-623-670	0 986 487 049
43153-671-003	0 986 487 049
43153-679-003	0 986 487 049
43153-679-013	0 986 487 049
43153-679-601	0 986 487 049

43153-692-003	0 986 487 296
43154-SA3-003	0 986 487 385
43154 SM4 A01	0 986 487 440
43154 S47 N01	0 986 487 686
43154-623-670	0 986 487 049

43155 SM4 A01	0 986 487 440
43157-567-000	0 986 487 049
43516-567-000	0 986 487 049
44400 SK3 E10	0 986 478 657
45022 SEAEZ1	0 986 494 135

45022 SEAE01	0 986 494 135
45022 SMG E00	0 986 494 136
45022 SMG E01	0 986 494 136
45022 SMG E50	0 986 494 136
45022 S1A E63	0 986 424 826

45022 S9A A01	0 986 424 809
45022 S9A E60	0 986 424 809
45251 SAA G00	0 986 479 033
45251 SAA G11	0 986 479 033
45251-SA0-000	0 986 478 651

45251-SA0-010	0 986 478 651
45251-SA0-640	0 986 478 651
45251-SA0-660	0 986 478 676
45251-SA5-000	0 986 478 676
45251-SA5-010	0 986 478 676

45251-SA6-670	0 986 478 202
45251-SA7-600	0 986 478 348
45251-SB0-000	0 986 478 204
45251-SB0-951	0 986 478 204
45251-SB2-010	0 986 478 239

45251-SB2-020	0 986 478 239
45251-SB2-720	0 986 478 239
45251-SB2-730	0 986 478 239
45251-SB2-731	0 986 478 239
45251-SB2-732	0 986 478 239

45251-SB2-750	0 986 478 203
45251-SB2-751	0 986 478 203
45251-SB2-752	0 986 478 203
45251-SB2-780	0 986 478 503
45251-SB2-781	0 986 478 503

45251-SB2-782	0 986 478 503
45251-SB2-920	0 986 478 203
45251-SB2-930	0 986 478 203
45251-SB2-931	0 986 478 203
45251-SB2-932	0 986 478 203

45251-SB2-980	0 986 478 503
45251 SCA E00	0 986 479 365
45251 SCA E50	0 986 479 365
45251 SD4 E00	0 986 478 447
45251-SD4-000	0 986 478 447

45251 SEA E30	0 986 479 227
45251-SE0-010	0 986 478 202
45251-SF0-000	0 986 478 240
45251 SH1 A00	0 986 478 115
45251 SH3 A00	0 986 478 115

45251 SK3 E00	0 986 478 657
45251 SK7 A00	0 986 478 174
45251 SK7 A10	0 986 478 174
45251 SK7 J00	0 986 478 174
45251-SK7-000	0 986 478 174

45251 SMG G10	0 986 479 364
45251 SM4 G02	0 986 478 448
45251-SM4-000	0 986 478 568
45251-SM4-010	0 986 478 568
45251-SM4-020	0 986 478 568

45251 SM5 A00	0 986 478 634
45251 SN7 E40	0 986 478 568
45251 SN7 E50	0 986 478 448
45251-SP0-000	0 986 478 667
45251 SRO A00	0 986 478 174

45251 SRO A10	0 986 478 174
45251 SR3 A10	0 986 478 115
45251 SSO A00	0 986 478 681
45251-SS0-000	0 986 478 415
45251 ST3 E10	0 986 478 174

45251 SZ 3E00	0 986 478 667
45251-SZ3-000	0 986 478 667
45251 S1AE20	0 986 479 032
45251 S1AG00	0 986 478 982
45251 S1A G60	0 986 478 415

45251 S2 HN00	0 986 478 667
45251 S50 G00	0 986 479 033
45251 S6D E10	0 986 478 174
45251 S6FE10	0 986 479 226
45251 S7A E10	0 986 479 364

45251 S7AN10	0 986 479 365
45251-692-000	0 986 478 676
45251-692-003	0 986 478 676
45251-693-000	0 986 478 676

HYUNDAI

51712 02100	0 986 478 727
51712 02110	0 986 478 727
51712 02550	0 986 479 264

51712 02551	0 986 479 264
51712 1C000	0 986 479 206
51712 1C050	0 986 479 459
51712 1G000	0 986 479 367
51712 1H000	0 986 479 460

51712 11100	0 986 478 783
51712 2C000	0 986 479 368
51712 2D300	0 986 479 207
51712 2D310	0 986 479 207
51712 2E300	0 986 479 368

51712 21A00	0 986 478 162
51712 21B00	0 986 478 674
51712 21300	0 986 478 162
51712 21350	0 986 478 674
51712 24100	0 986 478 674

51712 25060	0 986 479 377
51712 25061	0 986 479 289
51712 25061	0 986 479 377
51712 28000	0 986 478 665
51712 28300	0 986 478 675

51712 3B000	0 986 479 124
51712 3D100	0 986 479 229
51712 3D300	0 986 479 229
51712 3K050	0 986 479 368
51712 33001	0 986 478 673

51712 33010	0 986 478 673
51712 38100	0 986 478 774
58101 H1A00	0 986 494 138
58101 H1A10	0 986 494 138
58101 M2A02	0 986 424 810

58101 OXA01	0 986 494 064
58101 O2A10	0 986 494 155
58101 O5A10	0 986 494 155
58101 O5A30	0 986 494 155
58101 1GA00	0 986 494 139

58101 1GE00	0 986 494 139
58101 1HA10	0 986 424 811
58101 1HA20	0 986 424 811
58101 17A00	0 986 424 810
58101 2CA10	0 986 424 815

58101 2CA20	0 986 424 815
58101 2DA40	0 986 424 810
58101 2DA60	0 986 424 810
58101 2D050	0 986 424 810
58101 2EA10	0 986 424 815

58101 2EA11	0 986 424 815
58101 2EA21	0 986 424 815
58101 2SA31	0 986 424 810
58101 38A81	0 986 424 815
58101 38A90	0 986 424 815

58129 4A000	0 986 478 663
58129 44010	0 986 478 664
58302 H1A00	0 986 494 137
58302 H1A10	0 986 494 137
58302 OXA00	0 986 494 145

58305 02A00	0 986 487 581
58305 02A10	0 986 487 581
58305 1CA00	0 986 487 697
58305 1CA10	0 986 487 697
58305 1GA00	0 986 487 748

58305 17A00	0 986 487 673
58305 2DA10	0 986 487 673
58305 21300	0 986 487 617
58305 22A01	0 986 487 462
58305 23A00	0 986 487 399

58305 24A20	0 986 487 400
58305 25A00	0 986 487 655
58305 25A10	0 986 487 673
58305 26A00	0 986 487 634
58305 26A10	0 986 487 634

58305 28A70	0 986 487 387
58305 29A00	0 986 487 387
58305 29A00	0 986 487 693
58305 29A10	0 986 487 693
58305 34A10	0 986 487 648

58305 44A00	0 986 487 648
58305 44A10	0 986 487 648
58305 44A40	0 986 487 648
58315 11050	0 986 487 280
58350 H1A40	0 986 487 737

58350 1HA00	0 986 487 750
58350 2EA00	0 986 487 738
58350 2EA10	0 986 487 711
58350 26A00	0 986 487 711
58350 26A10	0 986 487 711

58350 3AA00	0 986 487 711
58411 M2050	0 986 478 655
58411 1C800	0 986 479 371
58411 28300	0 986 479 484
58411 29300	0 986 479 484

58411 29310	0 986 479 484
58411 3A300	0 986 479 126
58411 3C000	0 986 479 125
58411 38310	0 986 479 125
58411 39300	0 986 479 345

58411 39600	0 986 479 345
-------------	----------------------

INNOCENTI (NUOVA INNOCENTI)

5890763	0 986 487 337
---------	----------------------

ISUZU

8-94104-258-1	0 986 487 333
8-94113-628-0	0 986 478 658
8-94113-628-1	0 986 478 658

8-94113-629-1	0 986 478 658
8-94172-376-1	0 986 478 596
8-94375-416-3	0 986 478 854
8-94375-533-3	0 986 478 437
8-97034-035-3	0 986 478 437

8-97046-080-0	0 986 478 437
9 4242 571	0 986 478 658

IVECO

1904529	0 986 478 742
1904531	0 986 478 649
1906042	0 986 487 287

1906172	0 986 487 287
1906350	0 986 487 287
1906351	0 986 487 375
1906352	0 986 487 347
1908772	0 986 478 885

1908773	0 986 478 886
2991646	0 986 479 161
42470836	0 986 479 162
42471034	0 986 479 163
7180256	0 986 478 886

8584182	0 986 478 649
93800492	0 986 478 742
93821918	0 986 478 885

JEEP

J3251156	0 986 478 694
4713365	0 986 487 529
4796310	0 986 487 529

5015 965AA	0 986 479 386
5191 271AA	0 986 424 814
5191 271AB	0 986 424 814
5200 5000	0 986 479 386
52008 184	0 986 479 455

83 03 251 156	0 986 478 694
83 08 133 818	0 986 487 325
98 83 251 156	0 986 478 694

KIA

DA01-33-251	0 986 478 429
E8BZ-11-25A	0 986 478 429
KDX74 33251	0 986 478 219

KJ002 33251C	0 986 479 013
KK150 2638Z	0 986 487 388
KK150 33251	0 986 478 429
MDA01 33251	0 986 478 429
OK01A 3325XB	0 986 479 020

OK01A 33251C	0 986 479 020
OK01A 33251D	0 986 479 020
OK01A 33251D	0 986 479 127
OK011 2638Z	0 986 487 740
OK011 33251E	0 986 479 020

OK2AA 33251A	0 986 478 781
OK2AA 33251B	0 986 478 781
OK2AA 33251C	0 986 478 781
OK2FA 33251	0 986 479 353
OK2FC 2628Z	0 986 424 693

OK2JA 3328Z	0 986 424 811
OK2JA 3328ZA	0 986 424 811
OK2N1 2638Z	0 986 487 591
OK2N1 3328Z	0 986 494 144
OK2N1 3328ZA	0 986 494 144

OK20A 33251	0 986 478 659
OK20A 33251A	0 986 478 659
OK201 2638Z	0 986 487 591
OK23N 2638Z	0 986 487 636
OK30A 2628Z	0 986 487 688

OK55A 33251	0 986 479 444
OK55B 33251	0 986 479 444
OK552 2638Z	0 986 487 659
OK552 33251	0 986 479 013
OK56A 2638Z	0 986 487 659

OK56A 2638ZA	0 986 487 659
OK56A 33251	0 986 479 013
OK58A 2638Z	0 986 487 709
OK9AA 26251	0 986 479 018
OK9AA 26251A	0 986 479 018

OK9AA 26251B	0 986 479 018
OK9AA 26251C	0 986 479 018
OK9AA 33251	0 986 479 008
OK9AA 33251	0 986 479 019
OK9AA 33251A	0 986 479 008

OK9AA 33251B	0 986 479 008
OK9AA 33251C	0 986 479 008
OK9A0 2628Z	0 986 424 693
OK9D0 3328Z	0 986 494 146
51712 FD300	0 986 479 231

51712 M2000	0 986 478 531
51712 M2010	0 986 478 531
51712 07500	0 986 479 286
51712 1G000	0 986 479 367
51712 2F100	0 986 479 369

51712 3E000	0 986 479 230
58101 07A10	0 986 494 064
58101 07A20	0 986 494 064
58101 1FE01	0 986 424 815
58101 1GA00	0 986 494 139

58101 1GE00	0 986 494 139
58101 1HA00	0 986 424 811
58101 2FA10	0 986 494 146
58101 2FA20	0 986 494 146
58101 3EE00	0 986 494 143

58101 3EE01	0 986 494 143
58101 3KA40	0 986 424 815
58115 FDA00	0 986 494 144
58115 FDC00	0 986 494 146
58302 07A00	0 986 494 145

58302 07A10	0 986 494 145
58305 1GA00	0 986 487 748
58315 FDA00	0 986 487 687
58315 FDA01	0 986 487 687
58350 1HA00	0 986 487 750



NAY0 33 23ZB	0 986 424 303
NAY1 33 23Z	0 986 424 303
NAY1 33 23ZA	0 986 424 303
NAZO 33 28Z	0 986 424 303
NA01-26-251	0 986 478 242
NA01-26-251A	0 986 478 242
NA01-26-251C	0 986 478 242
NA01-26-251D	0 986 478 242
NA01 33 25X	0 986 478 241
NA01 33 25XA	0 986 478 241
NA01 33 25XC	0 986 478 241
NA01 33 25XD	0 986 478 241
NA75 33 25X	0 986 478 996
NA75 33 25XC	0 986 478 996
NOYY-26-251	0 986 479 473
NOYY-26-251A	0 986 479 473
NOYY-26-251B	0 986 479 473
NOYY 33 25X	0 986 479 472
NO26 33 25X	0 986 478 996
NO26 33 25XC	0 986 478 996
N06Y-26-251	0 986 479 473
N06Y-26-251A	0 986 479 473
N06Y-26-251B	0 986 479 473
N06Y 33 25X	0 986 479 472
N12Y 33 25X	0 986 479 474
N12Y 33 25XA	0 986 479 474
N123-26-251A	0 986 479 131
SAY1 33 23Z	0 986 424 303
SB40-49-380	0 986 487 480
SE28 26 38ZA	0 986 487 359
SO83-33-251	0 986 478 802
SO83-33-251A	0 986 478 802
SO83-33-251B	0 986 478 802
S121-49-380	0 986 487 480
TY01 3325X	0 986 479 016
TY07 3325XA	0 986 479 016
T002 3325XA	0 986 479 016
UB39-33-251	0 986 478 802
UB39-33-251A	0 986 478 802
UC86 33 25X	0 986 478 699
UC86 33 25XC	0 986 478 699
UC86-33-251	0 986 478 699
0305-26-310	0 986 487 411
0370-26-310	0 986 487 411
0370-49-230A	0 986 487 411
0433-33-310B	0 986 487 355
1E00-26-251	0 986 477 044
1E00-26-251A	0 986 477 044
1E00 26 38Z	0 986 487 553
1E01-26-251	0 986 477 099
1E01-26-251A	0 986 477 099
1E03-33-251	0 986 478 856
1E06-33-251	0 986 478 502
1011-26-310A	0 986 487 431
1045392	0 986 477 044

1312-49-230	0 986 487 355
1823-26-310B	0 986 487 461
3514-26-310A	0 986 487 431
3958-26-310B	0 986 487 411
3960-26-310	0 986 487 411
6311-26-251A	0 986 478 440
7296356	0 986 477 044
8124-33-310	0 986 487 411
8173-33-251	0 986 478 695
8173-33-251A	0 986 478 695
8471-26-310A	0 986 487 355
8569-33-251	0 986 478 804
8569-33-251A	0 986 478 804
8595-26-310	0 986 487 355
8854-26-310	0 986 487 461
8854-49-230	0 986 487 461
MERCEDES-BENZ	
000 421 60 91	1 987 474 241
000 421 61 10	0 986 494 081
000 421 62 10	0 986 494 082
000 540 02 17	1 987 474 901
000 540 02 17	1 987 474 911
001 421 09 10	0 986 494 081
001 421 10 10	0 986 494 082
002 420 47 20	0 986 487 605
002 420 58 20	0 986 487 610
002 420 59 20	0 986 487 611
003 420 06 20	0 986 424 830
003 420 14 20	0 986 487 610
003 420 19 20	0 986 424 830
003 420 24 20	0 204 204 174
003 420 34 20	0 986 487 611
003 420 70 20	0 986 487 605
004 420 40 20	0 986 494 165
004 420 51 20	0 986 494 166
004 420 62 20	0 986 494 167
004 420 69 20	0 986 494 123
004 420 80 20	0 986 494 167
004 420 81 20	0 986 494 122
004 420 82 20	0 986 494 194
004 420 83 20	0 986 494 121
004 420 86 20	0 986 487 723
005 420 07 20	0 986 494 162
005 420 08 20	0 986 494 161
005 420 09 20	0 986 494 161
005 420 21 20	0 986 494 121
005 420 52 20	0 986 494 121
108 420 01 20	0 986 487 126
108 420 01 20	0 986 487 542
114 421 00 12	0 986 478 058

115 420 00 72	0 986 478 199
115 420 01 72	0 986 478 055
115 420 02 72	0 986 478 057
115 421 11 12	0 986 478 055
115 421 13 12	0 986 478 057
115 421 14 12	0 986 478 058
115 423 02 12	0 986 478 199
115 423 04 12	0 986 478 199
116 420 01 72	0 986 478 060
116 420 02 05	0 986 478 060
120 420 14 20	0 986 487 126
120 420 14 20	0 986 487 542
120 420 15 20	0 986 487 126
120 420 15 20	0 986 487 542
123 412 01 20	0 986 487 126
123 412 01 20	0 986 487 542
123 420 00 72	0 986 478 058
123 420 01 20	0 986 487 126
123 420 01 20	0 986 487 542
123 421 00 12	0 986 478 058
123 540 00 17	1 987 474 901
123 540 00 17	1 987 474 911
124 420 02 20	0 986 487 543
124 420 03 20	0 986 487 543
124 420 05 20	0 986 487 543
124 420 07 20	0 986 487 543
124 421 13 12	0 986 478 187
124 421 14 12	0 986 478 589
124 421 15 12	0 986 478 525
124 421 16 12	0 986 478 186
124 421 23 12	0 986 478 589
124 421 24 12	0 986 478 428
124 421 26 12	0 986 478 526
124 421 27 12	0 986 478 186
124 423 05 12	0 986 478 325
124 423 08 12	0 986 479 133
124 423 11 12	0 986 478 626
126 412 01 20	0 986 487 126
126 412 01 20	0 986 487 542
126 420 00 05	0 986 478 061
126 420 01 20	0 986 487 126
126 420 01 20	0 986 487 542
126 420 01 72	0 986 478 061
126 420 02 72	0 986 478 184
126 421 04 12	0 986 478 197
126 421 05 12	0 986 478 197
126 423 00 12	0 986 478 199
126 423 02 12	0 986 478 199
126 540 20 17	1 987 474 901
129 421 03 12	0 986 478 186
129 421 06 12	0 986 478 526
129 421 10 12	0 986 478 526
129 421 15 12	0 986 478 791
129 421 16 12	0 986 478 792
129 421 17 12	0 986 478 791

129 421 18 12	0 986 478 792
129 421 20 12	0 986 478 526
129 423 00 12	0 986 478 565
129 423 03 12	0 986 478 793
129 423 04 12	0 986 478 446
140 420 04 20	0 986 487 344
140 420 08 20	0 986 487 344
140 420 09 20	0 986 487 344
140 421 02 12	0 986 478 527
140 421 03 12	0 986 478 528
140 421 09 12	0 986 478 527
140 421 10 12	0 986 478 527
140 423 04 12	0 986 478 566
140 423 06 12	0 986 478 607
140 540 12 17	1 987 474 901
155 421 14 12	0 986 478 058
163 420 02 20	0 986 487 609
163 420 07 20	0 986 424 805
163 420 09 20	0 986 424 805
163 421 00 12	0 986 478 468
163 421 01 12	0 986 478 469
163 421 02 12	0 986 478 468
163 421 03 12	0 986 479 405
163 423 00 12	0 986 478 995
163 423 01 12	0 986 478 469
163 540 15 17	1 987 473 011
163 540 17 17	1 987 473 011
164 420 06 20	0 986 487 705
164 420 08 20	0 986 494 165
164 420 18 20	0 986 494 165
164 421 04 12	0 986 479 269
164 421 05 12	0 986 479 329
164 423 05 12	0 986 479 330
164 423 06 12	0 986 479 285
168 420 01 20	0 986 424 469
168 420 02 20	0 986 487 565
168 420 03 20	0 986 487 565
168 420 07 20	0 986 424 469
168 420 08 20	0 986 424 469
168 420 12 20	0 986 424 469
168 421 00 90	1 987 475 231
168 421 01 12	0 986 478 874
168 421 02 12	0 986 478 875
168 421 06 12	0 986 478 474
168 421 08 12	0 986 478 875
168 423 02 01	0 986 477 096
168 423 02 12	0 986 478 475
169 420 01 20	0 986 494 085
169 420 02 20	0 986 494 087
169 420 03 20	0 986 494 087
169 420 08 20	0 986 494 085
169 420 09 20	0 986 494 087
169 420 10 20	0 986 494 087
169 421 00 12	0 986 479 185
169 421 01 12	0 986 479 186



◀ MERCEDES-BENZ

169 421 02 12	0 986 479 234
169 423 03 12	0 986 479 235
201 420 08 20	0 986 487 543
201 421 08 12	0 986 478 114
201 421 12 12	0 986 478 114

201 421 13 12	0 986 478 330
201 421 15 12	0 986 478 330
201 423 09 12	0 986 478 188
201 423 11 12	0 986 478 188
201 423 12 12	0 986 478 188

201 540 03 17	1 987 474 912
202 421 02 12	0 986 478 262
202 421 09 12	0 986 478 301
202 423 00 12	0 986 478 255
202 540 07 17	1 987 473 057

203 420 01 20	0 986 487 582
203 421 03 12	0 986 478 624
203 421 05 12	0 986 478 876
203 421 13 12	0 986 479 135
204 421 00 12	0 986 479 406

204 421 07 12	0 986 479 407
204 421 09 12	0 986 479 331
204 421 10 12	0 986 479 408
204 423 05 12	0 986 479 409
204 423 06 12	0 986 479 410

204 423 07 12	0 986 479 411
210 420 03 20	0 986 487 584
210 421 07 12	0 986 478 624
210 421 12 12	0 986 478 876
210 421 14 12	0 986 478 625

210 421 15 12	0 986 478 876
210 421 17 12	0 986 478 625
210 421 22 12	0 986 478 876
210 421 24 12	0 986 478 624
210 423 03 12	0 986 478 626

210 423 04 12	0 986 478 325
210 423 05 12	0 986 478 899
210 423 06 12	0 986 478 626
210 423 09 12	0 986 478 325
210 423 10 12	0 986 478 626

210 540 11 17	1 987 473 008
211 421 07 12	0 986 479 038
211 421 08 12	0 986 479 039
211 421 09 12	0 986 479 040
211 421 10 12	0 986 479 332

211 421 12 12	0 986 479 333
211 421 13 12	0 986 479 332
211 423 07 12	0 986 479 041
211 423 09 12	0 986 479 042
211 540 07 17	1 987 473 019

220 420 05 20	0 986 487 724
220 421 08 12	0 986 478 470
220 421 09 12	0 986 478 471
220 421 10 12	0 986 478 965
220 421 11 12	0 986 478 964

220 421 12 12	0 986 478 965
220 421 18 12	0 986 479 334
220 421 25 12	0 986 478 470
220 423 01 12	0 986 478 472
220 423 02 12	0 986 478 473

220 423 03 12	0 986 478 966
220 423 05 12	0 986 478 966
220 540 15 17	1 987 473 006
221 420 01 20	0 986 487 725
221 420 05 20	0 986 487 725

221 421 00 12	0 986 479 412
221 421 06 12	0 986 479 413
221 423 07 12	0 986 479 414
230 420 03 20	0 986 487 666
230 421 04 12	0 986 479 072

230 421 05 12	0 986 479 415
230 421 08 12	0 986 479 415
414 420 03 20	0 986 487 582
414 421 00 12	0 986 479 071
435 121 21 20	0 986 478 767

451 421 01 12	0 986 479 305
451 423 00 08	0 986 487 657
454 420 00 01	0 986 479 187
454 420 00 72	0 986 479 236
460 421 00 12	0 986 478 189

460 540 05 17	1 987 474 967
460 540 06 17	1 987 474 967
601 420 00 72	0 986 478 201
601 420 01 72	0 986 478 529
601 420 02 72	0 986 478 201

601 420 03 72	0 986 478 529
601 421 03 12	0 986 478 529
601 421 50 12	0 986 478 201
601 421 51 12	0 986 478 201
601 423 50 01	0 986 477 038

601 423 51 01	0 986 477 101
631 420 01 72	0 986 478 643
631 420 03 72	0 986 478 357
631 423 00 07	0 986 487 315
631 423 01 07	0 986 487 315

638 421 01 12	0 986 478 861
638 421 04 12	0 986 478 455
638 423 01 12	0 986 478 873
639 420 02 20	0 986 487 718
639 421 00 12	0 986 479 137

639 423 01 12	0 986 479 138
639 540 14 17	1 987 473 036
639 540 15 17	1 987 473 036
668 421 01 12	0 986 478 456
668 421 02 12	0 986 478 457

669 421 01 12	0 986 478 406
669 421 06 12	0 986 478 406
670 421 01 12	0 986 478 407
670 421 03 12	0 986 478 407
901 420 01 20	0 986 487 610

901 423 04 12	0 986 478 863
901 423 06 12	0 986 478 863
901 423 08 12	0 986 478 863
901 423 10 12	0 986 478 863
901 540 00 17	1 987 474 969

901 540 01 17	1 987 474 969
901 540 02 17	1 987 473 007
901 540 03 17	1 987 473 007
902 421 03 12	0 986 478 849
902 421 04 12	0 986 478 849

902 421 06 12	0 986 478 849
902 421 07 12	0 986 478 849
902 423 01 12	0 986 478 433
902 423 03 12	0 986 478 433
902 423 04 12	0 986 478 433

902 423 05 12	0 986 478 433
903 421 00 12	0 986 479 212
903 421 01 12	0 986 479 212
904 420 02 20	0 986 487 611
904 420 03 20	0 986 487 611

904 420 04 20	0 986 487 611
904 423 02 12	0 986 478 555
904 423 03 12	0 986 478 555
906 420 03 20	0 986 487 720
906 421 00 12	0 986 479 294

906 423 00 12	0 986 479 295
906 423 01 12	0 986 479 296
906 540 13 17	1 987 473 038
906 540 14 17	1 987 473 037
906 540 15 17	1 987 473 037

MITSUBISHI

HB403101	0 986 478 635
MA058582	0 986 478 162
MA169882	0 986 478 783

MA180733	0 986 487 059
MB004062	0 986 487 059
MB058582	0 986 478 162
MB134832	0 986 487 368
MB134845	0 986 478 784

MB139917	0 986 487 484
MB150655	0 986 487 335
MB151060	0 986 487 491
MB151061	0 986 487 491
MB151244	0 986 487 484

MB151387	0 986 478 251
MB193506	0 986 487 059
MB234076	0 986 478 253
MB238076	0 986 478 253
MB238107	0 986 487 484

MB238114	0 986 487 207
MB238363	0 986 487 335
MB238495	0 986 478 358
MB238520	0 986 487 207
MB238521	0 986 487 207

MB238522	0 986 487 207
MB238523	0 986 487 207
MB238615	0 986 478 254
MB316582	0 986 478 358
MB316676	0 986 478 253

MB316677	0 986 478 254
MB316729	0 986 478 162
MB366080	0 986 478 339
MB366143	0 986 487 208
MB366169	0 986 487 368

MB366433	0 986 478 162
MB366443	0 986 487 260
MB366444	0 986 487 260
MB366445	0 986 487 260
MB366446	0 986 487 260

MB366466	0 986 478 256
MB366480	0 986 478 339
MB407030	0 986 478 530
MB407031	0 986 478 706
MB407036	0 986 478 271

MB407038	0 986 AB6 902
MB407038	0 986 478 635
MB407039	0 986 478 635
MB407639	0 986 478 531
MB500555	0 986 478 272

MB500556	0 986 478 272
MB500822	0 986 487 479
MB500968	0 986 478 339
MB500969	0 986 478 339
MB534594	0 986 487 260

MB534595	0 986 487 260
MB534596	0 986 487 260
MB534597	0 986 487 260
MB534656	0 986 487 208
MB587432	0 986 478 707

MB587433	0 986 478 707
MB587658	0 986 487 479
MB587659	0 986 487 207
MB587660	0 986 487 207
MB587661	0 986 487 207

MB616677	0 986 478 254
MB618716	0 986 478 844
MB618734	0 986 478 277
MB618735	0 986 478 277
MB618736	0 986 478 282

MB618737	0 986 478 282
MB618797	0 986 478 713
MB668083	0 986 478 655
MB668107	0 986 478 531
MB668108	0 986 478 708



MB668745	0 986 487 455
MB668746	0 986 487 455
MB668747	0 986 487 455
MB668886	0 986 478 531
MB668886	0 986 478 654
MB699017	0 986 487 207
MB699018	0 986 487 207
MB699019	0 986 487 207
MB699280	0 986 478 636
MB699281	0 986 478 636
MB699282	0 986 478 572
MB699283	0 986 478 572
MB699288	0 986 478 898
MB699334	0 986 487 451
MB699335	0 986 487 451
MB699336	0 986 487 451
MB699716	0 986 479 469
MB699964	0 986 478 655
MB857763	0 986 479 237
MB858684	0 986 487 455
MB895464	0 986 478 714
MB928697	0 986 478 844
MB928994	0 986 478 531
MB928995	0 986 478 531
MB950064	0 986 487 451
MB950064	0 986 487 493
MB950211	0 986 487 685
MB950569	0 986 478 531
MB950569	0 986 478 654
MB950570	0 986 478 531
MB950570	0 986 478 654
MB950922	0 986 478 572
MN116929	0 986 424 814
MN150861	0 986 487 710
MN186120	0 986 487 746
MR128153	0 986 478 652
MR178823	0 986 487 207
MR178824	0 986 487 479
MR178826	0 986 487 684
MR178827	0 986 487 719
MR205215	0 986 479 372
MR205584	0 986 478 897
MR205585	0 986 478 897
MR249356	0 986 478 716
MR249357	0 986 479 237
MR249358	0 986 478 898
MR334996	0 986 479 470
MR389722	0 986 478 897
MR389724	0 986 478 708
MR 389725	0 986 479 140
MR391631	0 986 487 683
MR407116	0 986 478 990
MR407289	0 986 478 990
MR418067	0 986 479 373
MR449769	0 986 478 572

MR449818	0 986 479 035
MR465094	0 986 487 577
MR475330	0 986 478 531
MR496333	0 986 487 684
MR510741	0 986 479 471
MR510742	0 986 479 471
MR535718	0 986 487 710
MR913846	0 986 478 898
MR955068	0 986 424 814
MR955407	0 986 479 374
MR955408	0 986 479 374
MR981238	0 986 487 208
MS T05 044	0 986 487 059
MZ981150	0 986 487 059
MZ981179	0 986 487 207
MZ981180	0 986 487 207
MZ981184	0 986 487 260
M818027	0 986 478 493
M818027	0 986 479 139
3116118200	9 431 611 201
4605A068	0 986 479 187
4605A076	0 986 479 236
4800A001	0 986 487 739
5171211100	0 986 478 783
5171221300	0 986 478 162
NISSAN	
DA060 05B25	0 986 469 570
DD060 T6025	0 986 487 305
DD060 01W25	0 986 487 496
DD060 04A25	0 986 487 398
D1060 VK190	0 986 494 152
D4060 OW727	0 986 487 464
D4060 8H725	0 986 487 698
40206 AX600	0 986 479 103
40206 AX602	0 986 479 103
40206 AX603	0 986 479 103
40206 C7000	0 986 478 257
40206 C7001	0 986 478 257
40206 D0360	0 986 478 258
40206 D0361	0 986 478 258
40206 EB300	0 986 479 356
40206 EB320	0 986 479 357
40206 G9500	0 986 478 257
40206 JD00A	0 986 479 358
40206 JG00A	0 986 479 358
40206 U8700	0 986 478 173
40206 VB001	0 986 479 359
40206 VE800	0 986 479 031
40206 W1210	0 986 478 260

40206 W1260	0 986 478 260
40206 W1265	0 986 478 260
40206 W1270	0 986 478 260
40206 Y9503	0 986 478 458
40206 0F000	0 986 478 532
40206 0F001	0 986 478 532
40206 0M601	0 986 478 650
40206 0M602	0 986 478 650
40206 0M801	0 986 478 459
40206 0M802	0 986 478 459
40206 00QAD	0 986 479 001
40206 01B00	0 986 478 360
40206 01B01	0 986 478 360
40206 03R00	0 986 478 364
40206 05A00	0 986 478 261
40206 05A01	0 986 478 261
40206 09W00	0 986 478 367
40206 09W01	0 986 478 367
40206 1F500	0 986 479 354
40206 1W600	0 986 479 031
40206 10W00	0 986 478 806
40206 10W01	0 986 478 806
40206 15C11	0 986 478 484
40206 15C25	0 986 478 484
40206 15E00	0 986 478 361
40206 15E01	0 986 478 361
40206 16R00	0 986 478 364
40206 17B01	0 986 478 591
40206 2F501	0 986 478 728
40206 2L903	0 986 478 833
40206 2N301	0 986 479 238
40206 21B01	0 986 478 389
40206 27B01	0 986 478 637
40206 3X00B	0 986 479 357
40206 3Y502	0 986 479 030
40206 31G00	0 986 478 532
40206 31G01	0 986 478 532
40206 35G00	0 986 478 806
40206 35G01	0 986 478 806
40206 4U101	0 986 479 030
40206 4U103	0 986 479 030
40206 4U107	0 986 479 030
40206 41B05	0 986 478 591
40206 5F001	0 986 478 288
40206 5F003	0 986 478 288
40206 54C01	0 986 478 835
40206 55F01	0 986 478 728
40206 55F03	0 986 478 728
40206 58A00	0 986 478 533
40206 58A01	0 986 478 533
40206 59S02	0 986 478 710
40206 6W500	0 986 479 031
40206 60Y01	0 986 478 533
40206 61A01	0 986 478 368
40206 61A11	0 986 478 368

40206 71E01	0 986 478 567
40206 71E02	0 986 478 567
40206 71E05	0 986 478 567
40206 71E06	0 986 478 567
40206 72B00	0 986 479 354
40206 72B01	0 986 479 354
40206 88E01	0 986 478 833
40206 88E03	0 986 478 833
40206 88E04	0 986 478 833
40206 88E05	0 986 478 833
40206 9C000	0 986 478 685
40206 9C100	0 986 478 485
40206 9C101	0 986 478 485
40206 9X403	0 986 479 355
40206 90J01	0 986 478 534
40206 93J01	0 986 478 567
40207 15C25	0 986 478 484
41060 CC090	0 986 494 151
41060 EA025	0 986 494 151
41060 EB325	0 986 494 151
41060 EB326	0 986 494 151
41060 VB290	0 986 494 150
41060 VC091	0 986 494 150
41060 VC290	0 986 494 150
41060 VK190	0 986 494 152
41060 04B25	0 986 469 570
41060 04B90	0 986 469 570
41060 04B91	0 986 469 570
41060 05B25	0 986 469 570
41060 05B26	0 986 469 570
41060 05B90	0 986 469 570
41060 41B91	0 986 469 570
43202 01A01	0 986 477 080
43202 01A02	0 986 477 080
43202 08M00	0 986 477 080
43202 08M01	0 986 477 080
43202 08M02	0 986 477 080
43202 50A12	0 986 477 072
43202 61A10	0 986 477 072
43204 01B01	0 986 477 073
43206 JD00A	0 986 479 362
43206-00QAC	0 986 479 144
43206 00QAD	0 986 479 144
43206 05J03	0 986 479 385
43206 05J04	0 986 479 385
43206 1E410	0 986 AB6 130
43206 21B10	0 986 477 068
43206 4U101	0 986 479 067
43206 4U103	0 986 479 067
43206 42R01	0 986 478 284
43206 5F001	0 986 479 104
43206 5F012	0 986 477 069
43206 5F014	0 986 477 069
43206 50Y10	0 986 477 119
43206 54C00	0 986 478 836



◀ NISSAN

43206 54C01	0 986 478 836
43206 58Y01	0 986 478 865
43206 58Y02	0 986 478 865
43206 70A10	0 986 477 074
43206 74F00	0 986 478 997

43206 8H305	0 986 479 453
43206 8H700	0 986 479 453
43206 8H701	0 986 479 453
43206 97J10	0 986 477 136
43206 99J01	0 986 478 564

43206 99J04	0 986 479 105
43511 83E00	0 986 477 128
44060 AX625	0 986 487 668
44060 CY025	0 986 487 734
44060 D0125	0 986 487 288

44060 D5725	0 986 487 300
44060 G9825	0 986 487 651
44060 M1025	0 986 487 320
44060 M4925	0 986 487 288
44060 Q0125	0 986 487 164

44060 Q1325	0 986 487 164
44060 T0425	0 986 487 316
44060 T6025	0 986 487 305
44060 T6425	0 986 487 316
44060 U8725	0 986 487 164

44060 0F026	0 986 487 583
44060 0F027	0 986 487 583
44060 0W727	0 986 487 464
44060 0X825	0 986 487 700
44060-00QAG	0 986 487 570

44060 00QAK	0 986 487 699
44060 01A25	0 986 487 235
44060 01J25	0 986 487 530
44060 01W25	0 986 487 496
44060 04A25	0 986 487 398

44060 04B25	0 986 487 206
44060 05N25	0 986 487 369
44060 06F25	0 986 487 164
44060 08G25	0 986 487 369
44060 16C25	0 986 487 369

44060 16C26	0 986 487 369
44060 18B25	0 986 487 206
44060 20W25	0 986 487 305
44060 21G25	0 986 487 305
44060 25T25	0 986 487 651

44060 28B25	0 986 487 206
44060 3J325	0 986 487 699
44060 31B25	0 986 487 206
44060 31G25	0 986 487 392
44060 35G25	0 986 487 392

44060 37G25	0 986 487 464
44060 47L25	0 986 487 300
44060 47L26	0 986 487 300
44060 48L25	0 986 487 300
44060 48L26	0 986 487 300

44060 50Y25	0 986 487 578
44060 55L25	0 986 487 300
44060 56G26	0 986 487 464
44060 56L25	0 986 487 300
44060 56L26	0 986 487 300

44060 56L27	0 986 487 300
44060 6F625	0 986 487 604
44060 60A25	0 986 487 398
44060 60Y25	0 986 487 300
44060 68A25	0 986 487 235

44060 70J28	0 986 487 372
44060 70N25	0 986 487 300
44060 8H725	0 986 487 698
44060 8M126	0 986 487 691
44060 86R25	0 986 487 300

44060 9C026	0 986 487 313
44060 99B25	0 986 424 800
44060 99B26	0 986 487 391
44060 99B85	0 986 424 800
44070 N4600	0 986 487 164

44081 9C025	1 987 475 214
44081 9C026	1 987 475 214
44090 AX625	1 987 475 300
44090-00QAD	1 987 475 253
44090-00QAE	1 987 475 264

44090 9C025	1 987 475 214
-------------	----------------------

OPEL

1238343	1 987 474 907
1238349	1 987 474 923
1238353	1 987 474 906

1238369	1 987 474 922
1238403	1 987 474 930
1238404	1 987 474 928
1238408	1 987 474 908
1238421	1 987 474 970

1238442	1 987 474 973
1238783	1 987 474 971
1238948	1 987 474 929
1238984	1 987 474 929
13116560	1 987 473 033

13122323	1 987 474 973
13131256	1 987 473 017
13139260	1 987 473 039
13153473	1 987 473 018
16005080	1 987 475 043

16005090	1 987 475 044
1605007	1 987 474 277
1605041	0 986 487 613
1605042	0 986 487 614
1605064	0 986 487 658

1605275	0 986 487 150
1605292	0 986 487 538
1605297	0 986 487 071
1605302	0 986 487 150
1605305	1 987 475 045

1605354	0 986 494 157
1605355	0 986 494 092
1605356	0 986 494 222
1605359	0 986 494 157
1605382	0 986 487 072

1605459	0 986 487 703
1605462	0 986 487 069
1605477	0 986 487 068
1605478	0 986 487 109
1605568	0 986 487 068

1605590	0 986 487 199
1605591	0 986 487 201
1605592	0 986 487 213
1605593	0 986 487 213
1605594	0 986 487 201

1605674	0 986 487 213
1605686	0 986 487 214
1605689	0 986 487 199
1605690	0 986 487 201
1605734	0 986 487 201

1605742	0 986 487 068
1605743	0 986 487 109
1605744	0 986 487 072
1605764	0 986 487 214
1605771	0 986 487 109

1605772	0 986 487 072
1605773	0 986 487 072
1605774	0 986 487 199
1605781	0 986 487 213
1605792	0 986 487 199

1605811	0 986 487 263
1605812	0 986 487 264
1605897	0 986 487 214
1605914	0 986 487 671
1605920	0 986 487 554

1605921	0 986 487 214
1605938	0 986 487 214
1605939	0 986 424 467
1605947	0 986 424 466
1605965	0 986 424 528

1605969	0 986 487 658
1717100	0 986 487 150
18023377	0 986 424 467
18024962	0 986 424 466
24427919	1 987 474 968

24444064	0 986 477 100
2798600	0 986 487 150
418000	0 986 477 134
418001	0 986 477 135
418025	0 986 477 056

418051	0 986 477 056
418117	0 986 477 040
4241428	0 986 478 717
4401408	0 986 487 332
4403038	0 986 478 970

4403038	0 986 479 001
4700711	0 986 478 729
4704579	0 986 477 127
4704595	0 986 477 128
4706273	0 986 487 576

4706738	0 986 487 707
4706835	0 986 487 576
4706836	0 986 487 707
4708239	0 986 494 160
4708598	0 986 487 665

4750125	0 986 487 576
4804637	0 986 479 268
4804768	0 986 487 730
4808848	0 986 479 267
5 52 107	0 986 487 069

5 52 152	0 986 487 214
5 52 153	0 986 487 662
5 52 158	0 986 487 373
5 52 158	0 986 487 376
5 52 217	0 986 487 072

5 52 241	0 986 487 662
5 56 002	1 987 475 084
5 56 003	1 987 475 085
5 56 9026	0 986 479 262
5 68 038	0 986 477 022

5 68 039	0 986 477 018
5 68 051	0 986 477 022
5 68 053	0 986 477 021
5 68 054	0 986 477 018
5 68 056	0 986 477 022

5 68 057	0 986 477 018
5 68 058	0 986 477 021
5 68 060	0 986 477 104
5 68 063	0 986 477 100
5 69 000	0 986 478 730

5 69 001	0 986 478 327
5 69 008	0 986 478 079
5 69 011	0 986 478 079
5 69 014	0 986 478 082
5 69 015	0 986 478 082

5 69 017	0 986 478 080
5 69 018	0 986 478 079
5 69 020	0 986 478 081
5 69 026	0 986 478 082
5 69 028	0 986 478 080

5 69 030	0 986 478 081
5 69 031	0 986 478 192
5 69 036	0 986 478 264
5 69 038	0 986 478 326
5 69 039	0 986 478 265



5 69 040	0 986 478 266
5 69 041	0 986 478 079
5 69 042	0 986 478 327
5 69 044	0 986 478 593
5 69 046	0 986 478 535
5 69 050	0 986 478 854
5 69 051	0 986 478 437
5 69 053	0 986 478 594
5 69 054	0 986 478 192
5 69 055	0 986 478 535
5 69 056	0 986 478 588
5 69 057	0 986 478 486
5 69 058	0 986 478 880
5 69 059	0 986 478 881
5 69 060	0 986 478 883
5 69 061	0 986 479 113
5 69 100	0 986 479 394
5 69 101	0 986 478 267
5 69 102	0 986 478 504
5 69 104	0 986 478 496
5 69 105	0 986 478 430
5 69 106	0 986 478 496
5 69 107	0 986 478 487
5 69 108	0 986 478 882
5 69 109	0 986 478 884
5 69 111	0 986 478 882
5 69 115	0 986 479 106
5 69 201	0 986 478 085
5 69 203	0 986 478 085
5 69 204	0 986 478 328
5 69 206	0 986 478 086
5 69 208	0 986 478 609
5 69 209	0 986 478 420
5 69 210	0 986 478 436
5 69 801	0 986 478 596
6235623	1 987 473 017
6235647	1 987 473 033
6235648	1 987 473 039
6235674	1 987 473 018
6238075	1 987 474 973
6238230	1 987 474 968
6238322	1 987 474 933
6238323	1 987 474 934
6238388	1 987 474 972
6238389	1 987 474 936
6238399	1 987 474 974
90007526	0 986 477 040
90008001	0 986 478 082
90008003	0 986 478 080
90008005	0 986 478 081
90008006	0 986 478 192
90063339	0 986 487 214
90065903	0 986 478 079
90077721	0 986 477 022
90086193	0 986 478 080

90086194	0 986 477 021
90093417	0 986 487 069
90111242	0 986 478 081
90121445	0 986 478 192
90135264	0 986 477 022
90135504	0 986 477 040
90168958	0 986 477 018
90182658	0 986 487 201
90185106	1 987 474 906
90193915	0 986 477 021
90222362	0 986 478 267
90223919	0 986 478 265
90250546	0 986 478 327
90250705	1 987 474 907
90271133	0 986 478 326
90271134	0 986 478 265
90271135	0 986 478 266
90272328	0 986 478 267
90273259	0 986 487 214
90273262	0 986 487 199
90295087	0 986 478 327
90297485	0 986 487 068
90297932	0 986 478 504
90305792	1 987 474 930
90305918	1 987 474 928
90335785	1 987 474 923
90342177	1 987 474 922
90343962	1 987 474 908
90344650	0 986 478 593
90345102	1 987 474 971
90345699	0 986 478 086
90348319	0 986 478 328
90349868	0 986 487 214
90372058	1 987 474 970
90375224	0 986 478 535
90392559	0 986 478 593
90397655	0 986 487 213
90399218	0 986 487 199
90421727	0 986 478 535
90421796	0 986 487 263
90421797	0 986 487 264
90421872	0 986 478 086
90425491	1 987 474 929
90442513	0 986 478 717
90444513	0 986 478 609
90444681	0 986 487 201
90445525	0 986 478 430
90487103	0 986 478 594
90487402	0 986 478 327
90495034	0 986 477 100
90495144	1 987 474 934
90495145	1 987 474 933
90496327	0 986 478 588
90497051	1 987 474 972
90497052	1 987 474 936

90497879	0 986 478 881
90498321	1 987 474 973
90509107	0 986 477 056
90509590	0 986 478 430
90509606	0 986 487 214
90511111	0 986 478 192
90511128	0 986 478 535
90512029	0 986 478 588
90512792	0 986 487 554
90512907	0 986 487 214
90512909	0 986 478 420
90512910	0 986 478 436
90538302	1 987 474 974
90538928	0 986 477 104
90539466	0 986 478 883
90541931	0 986 487 214
90542180	0 986 478 487
90542181	0 986 478 486
90542862	0 986 487 263
90542863	0 986 487 264
90543385	0 986 487 373
90543385	0 986 487 376
90543394	0 986 487 662
90575113	0 986 478 884
91024352	0 986 477 018
9109408	0 986 487 332
9111038	0 986 479 001
9111045	0 986 478 970
9111283	0 986 478 113
91118872	0 986 477 145
91143043	0 986 487 526
91143303	0 986 487 373
9114843	0 986 487 707
91149589	0 986 487 526
91149642	0 986 487 671
91151563	0 986 478 496
91158369	0 986 487 554
91159915	0 986 479 078
91159916	0 986 479 271
91165426	0 986 479 078
9117676	0 986 478 880
9117677	0 986 478 881
9117678	0 986 478 883
9117771	0 986 478 882
9117772	0 986 478 884
9160398	0 986 478 745
9161446	0 986 487 525
9184405	0 986 479 113
9191247	0 986 479 076
9191336	0 986 479 142
9192127	1 987 474 277
9193872	0 986 478 729
9194477	0 986 479 113
9195052	0 986 479 394
9195293	0 986 478 486

9195981	0 986 479 189
9195985	0 986 479 190
9196050	0 986 478 730
9196287	0 986 477 134
9196290	0 986 477 135
9196291	0 986 487 613
9196292	0 986 487 614
9196587	0 986 478 882
9196592	0 986 478 731
9200132	0 986 424 528
9208531	0 986 477 127
9208532	0 986 477 128
9209090	0 986 487 576
9212698	0 986 487 576
9214834	0 986 487 576
9280751	0 986 478 082
9293027	1 987 475 045
93170618	0 986 487 658
93171065	0 986 487 658
93171497	0 986 479 107
93171500	0 986 479 076
93171778	0 986 479 142
93171848	0 986 479 106
93172113	0 986 487 662
93175376	0 986 479 077
93175606	0 986 479 143
93176117	0 986 424 528
93176389	0 986 479 370
93176548	0 986 479 191
93178789	0 986 424 528
93179462	0 986 479 370
93182284	0 986 478 086
93188916	0 986 479 402
93188917	0 986 479 223
93188918	0 986 479 224
93188919	0 986 479 262
93189219	0 986 477 100
93189815	0 986 494 092
93189816	0 986 494 157
93189822	0 986 494 092
93189823	0 986 494 094
93189823	0 986 494 222
93190003	0 986 487 703
93190338	0 986 494 127
93191698	0 986 494 157
93192962	0 986 494 160
93193429	0 986 487 665
93850649	0 986 479 144
93850649	0 986 479 271
94126504	0 986 478 658
94172376	0 986 478 596
94232375	0 986 478 658
94340026	0 986 487 373
94340026	0 986 487 376
95175281	0 986 477 018

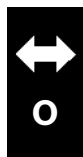

◀ OPEL

96058796	0 986 478 539
96175281	0 986 477 018
96179110	0 986 478 327
96625871	0 986 487 730
96625948	0 986 479 267

9662873	0 986 479 268
97034034	0 986 478 854
97034035	0 986 478 437
97034036	0 986 478 496

PEUGEOT

AM 451 016 A	0 986 487 447
AM 451 018 A	0 986 487 322
AM 451 23	0 986 478 050

AZ 451 016 A	0 986 487 124
AZ 451 19	0 986 487 322
GX 211 700 1A	0 986 478 231
ZF 04 449 694	0 986 477 031
ZF 04 450 931	0 986 478 067

ZF 07 531 819	0 986 478 200
ZF 07 568 501	0 986 478 067
ZF 44 509 31	0 986 478 067
ZF 93 500 521	0 986 478 234
3701 40	0 986 478 091

4236 14	0 986 487 081
4236 46	0 986 487 020
4236 49	0 986 487 081
4238 07	0 986 487 285
4238 10	0 986 487 456

4238 20	0 986 487 441
4238 23	0 986 487 441
4238 33	0 986 487 403
4238 35	0 986 487 413
4238 38	0 986 487 499

4238 40	0 986 487 319
4238 46	0 986 487 020
4238 49	0 986 487 020
4238 80	0 986 487 437
4238 83	0 986 487 076

4238 83	0 986 487 381
4238 86	0 986 487 076
4238 86	0 986 487 381
4238 96	0 986 487 456
4238 99	0 986 487 128

4241 A1	0 986 487 499
4241 A2	0 986 487 437
4241 A3	0 986 487 449
4241 A4	0 986 487 336
4241 E5	0 986 487 533

4241 E6	0 986 487 084
4241 E7	0 986 487 252
4241 E8	0 986 487 274
4241 E9	0 986 487 383
4241 G3	0 986 487 346

4241 G5	0 986 487 383
4241 G6	0 986 487 567
4241 G7	0 986 487 606
4241 H4	0 986 487 521
4241 H5	0 986 487 522

4241 H6	0 986 487 749
4241 H7	0 986 487 545
4241 H8	0 986 487 128
4241 H9	0 986 487 313
4241 J0	0 986 487 567

4241 J1	0 986 487 585
4241 J2	0 986 487 579
4241 J3	0 986 487 383
4241 J4	0 986 487 549
4241 J5	0 986 487 585

4241 J6	0 986 487 274
4241 J7	0 986 487 579
4241 J8	0 986 487 552
4241 J9	0 986 487 274
4241 K1	0 986 487 567

4241 K2	0 986 487 567
4241 K3	0 986 487 567
4241 K4	0 986 487 579
4241 K5	0 986 487 568
4241 K6	0 986 487 545

4241 K8	0 986 487 552
4241 K9	0 986 487 579
4241 L0	0 986 487 664
4241 L1	0 986 487 712
4241 L2	0 986 487 701

4241 L4	0 986 487 346
4241 L5	0 986 487 672
4241 L7	0 986 487 690
4241 L9	0 986 487 712
4241 N0	0 986 487 712

4241 N2	0 986 487 665
4241 N2	0 986 487 695
4241 N3	0 986 487 721
4241 N4	0 986 487 522
4241 N5	0 986 487 726

4241 N6	0 986 487 739
4241 N8	0 986 487 729
4241 P0	0 986 487 702
4241 O1	0 986 487 341
4241 15	0 986 487 076

4241 19	0 986 487 089
4241 25	0 986 487 084
4241 43	0 986 487 275
4241 49	0 986 487 020
4241 50	0 986 487 426

4241 51	0 986 487 403
4241 52	0 986 487 341
4241 55	0 986 487 243
4241 56	0 986 487 076
4241 57	0 986 487 275

4241 59	0 986 487 313
4241 71	0 986 487 084
4241 72	0 986 487 533
4241 73	0 986 487 274
4241 79	0 986 487 383

4241 91	0 986 487 076
4241 94	0 986 487 541
4241 95	0 986 487 319
4241 97	0 986 487 456
4241 98	0 986 487 441

4241 99	0 986 487 020
4246 A0	0 986 478 234
4246 A1	0 986 478 359
4246 A2	0 986 478 359
4246 A4	0 986 478 051

4246 A5	0 986 478 046
4246 A6	0 986 478 211
4246 A7	0 986 478 370
4246 A8	0 986 478 089
4246 A9	0 986 478 090

4246 B1	0 986 478 268
4246 B2	0 986 478 091
4246 B3	0 986 478 067
4246 B4	0 986 478 200
4246 B7	0 986 478 801

4246 B8	0 986 478 770
4246 C0	0 986 479 288
4246 E0	0 986 479 192
4246 E4	0 986 478 121
4246 E7	0 986 478 140

4246 E8	0 986 478 140
4246 F0	0 986 479 239
4246 F1	0 986 478 556
4246 F4	0 986 478 125
4246 F6	0 986 478 125

4246 F8	0 986 478 246
4246 G0	0 986 478 246
4246 G1	0 986 478 834
4246 G6	0 986 478 464
4246 G9	0 986 478 359

4246 H0	0 986 478 371
4246 H1	0 986 478 092
4246 H2	0 986 478 094
4246 H3	0 986 478 234
4246 H5	0 986 478 556

4246 H8	0 986 478 896
4246 H9	0 986 478 896
4246 J0	0 986 479 239
4246 J2	0 986 478 812
4246 J3	0 986 478 812

4246 J5	0 986 478 435
4246 J6	0 986 478 435
4246 J8	0 986 478 843
4246 J9	0 986 478 843
4246 K2	0 986 478 842

4246 K3	0 986 478 842
4246 K9	0 986 478 556
4246 L0	0 986 478 125
4246 L2	0 986 478 434
4246 L3	0 986 478 434

4246 L6	0 986 478 879
4246 L7	0 986 478 877
4246 L8	0 986 478 831
4246 L9	0 986 478 830
4246 N0	0 986 478 831

4246 N1	0 986 478 556
4246 P1	0 986 479 114
4246 P2	0 986 479 114
4246 P3	0 986 479 064
4246 P4	0 986 479 064

4246 P5	0 986 479 288
4246 P7	0 986 479 193
4246 P8	0 986 479 192
4246 P9	0 986 479 194
4246 R2	0 986 478 847

4246 R3	0 986 478 268
4246 R4	0 986 478 847
4246 R5	0 986 478 268
4246 R6	0 986 478 980
4246 R7	0 986 478 831

4246 R8	0 986 478 887
4246 R9	0 986 478 887
4246 T1	0 986 479 024
4246 T2	0 986 479 026
4246 T6	0 986 478 877

4246 T7	0 986 478 877
4246 T8	0 986 478 980
4246 T9	0 986 478 834
4246 V0	0 986 478 834
4246 V1	0 986 479 024

4246 V3	0 986 478 834
4246 V4	0 986 478 732
4246 V5	0 986 479 027
4246 V7	0 986 478 733
4246 W1	0 986 478 618

4246 W2	0 986 478 979
4246 W3	0 986 478 980
4246 W4	0 986 478 981
4246 W5	0 986 478 268
4246 W6	0 986 478 268

4246 W7	0 986 478 618
4246 W8	0 986 478 979
4246 W9	0 986 478 608
4246 X8	0 986 478 608
4246 X9	0 986 479 297

4246 Y1	0 986 479 297
4246 Y3	0 986 478 842
4246 Y7	0 986 479 065
4246 Y9	0 986 479 065
4246 Z1	0 986 479 066

4246 Z3	0 986 479 066
4246 Z7	0 986 479 168
4246 Z8	0 986 479 168
4246 Z9	0 986 479 219
4246 Z9	0 986 479 279
4246 42	0 986 478 091
4246 61	0 986 478 092
4246 63	0 986 478 051
4246 69	0 986 478 770
4246 70	0 986 478 094
4246 78	0 986 478 089
4246 83	0 986 478 052
4246 84	0 986 478 091
4246 85	0 986 478 067
4246 88	0 986 478 090
4246 89	0 986 478 046
4246 90	0 986 478 211
4246 91	0 986 478 189
4246 93	0 986 478 200
4246 94	0 986 478 370
4246 95	0 986 478 200
4246 96	0 986 478 067
4246 97	0 986 478 268
4246 98	0 986 478 094
4246 99	0 986 478 371
4247 21	0 986 477 097
4247 22	0 986 477 031
4247 24	0 986 477 060
4247 25	0 986 477 020
4247 27	0 986 477 019
4247 30	0 986 477 019
4247 31	0 986 477 020
4247 31	0 986 477 114
4247 32	0 986 477 070
4247 32	0 986 477 113
4247 33	0 986 477 066
4247 33	0 986 477 118
4247 35	0 986 477 116
4247 37	0 986 477 144
4247 38	0 986 477 098
4247 40	0 986 477 126
4247 41	0 986 477 124
4247 42	0 986 477 066
4247 42	0 986 477 118
4247 43	0 986 477 066
4247 43	0 986 477 118
4247 44	0 986 477 116
4247 45	0 986 477 124
4247 46	0 986 477 151
4247 47	0 986 477 124
4247 48	0 986 477 148
4247 49	0 986 477 124
4249 14	0 986 479 311
4249 15	0 986 478 618
4249 16	0 986 478 618

4249 17	0 986 478 979
4249 18	0 986 478 979
4249 19	0 986 479 255
4249 19	0 986 479 275
4249 20	0 986 479 266
4249 22	0 986 479 379
4249 23	0 986 479 379
4249 24	0 986 479 380
4249 25	0 986 479 380
4249 26	0 986 479 297
4249 27	0 986 479 297
4249 27	0 986 479 312
4249 28	0 986 479 313
4249 29	0 986 479 313
4249 30	0 986 479 399
4249 31	0 986 479 399
4249 32	0 986 479 255
4249 32	0 986 479 275
4249 33	0 986 479 288
4249 35	0 986 479 314
4249 36	0 986 479 314
4249 37	0 986 479 315
4249 38	0 986 479 315
4249 39	0 986 479 316
4249 40	0 986 479 316
4249 41	0 986 479 317
4249 42	0 986 479 317
4249 44	0 986 479 192
4249 45	0 986 479 383
4249 46	0 986 479 383
4249 46	0 986 479 387
4249 52	0 986 478 608
4249 54	0 986 479 239
4249 61	0 986 479 318
4249 62	0 986 479 318
4249 64	0 986 479 376
4249 65	0 986 479 388
4249 66	0 986 479 388
4249 73	0 986 478 639
4249 74	0 986 478 639
4249 76	0 986 478 810
4249 79	0 986 479 168
4252 60	0 986 424 825
4252 77	0 986 494 097
4252 78	0 986 494 098
4252 79	0 986 494 095
4252 94	0 986 494 098
4253 22	0 986 494 099
4253 26	0 986 494 095
4253 27	0 986 494 065
4253 35	0 986 494 097
4253 36	0 986 494 098
4253 37	0 986 494 098
4253 40	0 986 494 099
4253 43	0 986 424 825

4253 44	0 986 424 825
4253 47	0 986 494 097
4253 48	0 986 494 098
4253 55	0 986 494 111
4253 57	0 986 494 111
4253 59	0 986 494 110
4253 63	0 986 494 163
4253 64	0 986 494 163
4253 65	0 986 494 163
4253 66	0 986 494 163
4253 67	0 986 494 192
4253 68	0 986 494 192
4253 73	0 986 494 109
4253 75	0 986 494 109
4253 90	0 986 424 814
4253 93	0 986 494 261
4253 98	0 986 494 099
4254 01	0 986 494 099
4254 06	0 986 494 113
4254 11	0 986 494 098
4254 26	0 986 494 261
4257 9G	0 986 478 121
4308 11	1 987 475 030
4308 15	1 987 475 100
4308 17	1 987 475 141
4308 30	1 987 475 053
4308 34	1 987 475 100
4308 38	1 987 475 253
4308 40	1 987 475 220
4308 45	1 987 475 051
4308 50	1 987 475 214
4308 52	1 987 475 116
4308 53	1 987 475 205
4308 54	1 987 475 241
4308 55	1 987 475 257
4308 56	1 987 475 251
4308 57	1 987 475 253
4308 58	1 987 475 256
4308 59	1 987 475 255
4308 61	1 987 475 255
4308 62	1 987 475 162
4308 63	1 987 475 283
4308 64	1 987 475 319
4308 69	1 987 475 304
4308 70	1 987 475 295
4310 16	1 987 475 020
4315 13	1 987 475 173
4315 14	1 987 475 100
4427 55	1 987 474 197
4427 59	1 987 474 198
4427 63	0 204 104 019
4427 64	1 987 474 196
4427 65	1 987 474 194
4427 65	1 987 474 214
4427 66	1 987 474 028

4427 75	1 987 474 199
4427 94	1 987 474 028
4 449 694	0 986 477 031
5 416 277	0 986 478 761
5 416 277 B	0 986 478 761
5 426 184	0 986 478 741
5 429 669 S	0 986 478 218
5 448 826	0 986 478 231
5 448 826 V	0 986 478 231
5 489 362	0 986 478 232
5 489 362 D	0 986 478 232
5 501 420	0 986 487 319
6526 47	1 987 474 975
7 531 819	0 986 478 200
75 485 825	0 986 478 052
75 517 323	0 986 487 089
75 521 559	0 986 487 020
75 529 364	0 986 478 218
75 684 40	0 986 478 200
75 685 01	0 986 478 067
7851 531 000	0 986 478 091
7910 007 378	0 986 478 092
7910 007 463	0 986 478 051
7940 708 938	0 986 478 091
91 508 338	0 986 478 046
91 517 694	0 986 478 211
91 517 695	0 986 478 370
93 500 521	0 986 478 234
95 027 199	0 986 478 246
95 030 547	0 986 478 141
95 563 153	0 986 478 231
95 575 080	0 986 478 090
95 577 775	0 986 487 081
95 582 061	0 986 478 749
95 582 062	0 986 478 749
95 599 322	0 986 478 050
95 618 234	0 986 487 322
95 619 206	0 986 477 066
95 619 515	0 986 487 252
95 625 020	0 986 487 336
95 632 048	0 986 478 268
95 637 322	0 986 478 140
95 638 635	0 986 478 750
95 643 713	0 986 487 128
95 651 053	1 987 474 198
95 653 213	0 986 487 252
95 655 344	0 986 487 252
95 658 571	1 987 475 205
95 659 676	0 986 487 533
95 659 717	0 204 104 019
95 661 747	0 986 478 370
95 661 748	0 986 478 046
95 661 749	0 986 478 464
95 661 796	0 986 478 840
95 661 810	0 986 478 246



◀ PEUGEOT

95 661 811	0 986 478 142
95 661 812	0 986 478 140
95 661 813	0 986 478 125
95 661 814	0 986 478 141
95 661 848	0 986 478 750

95 661 849	0 986 478 749
95 661 850	0 986 478 232
95 663 080	0 986 487 322
95 667 809	0 986 478 268
95 667 810	0 986 478 834

95 667 811	0 986 478 604
95 667 820	0 204 104 021
95 667 820	1 987 474 199
95 669 226	0 986 478 751
96 012 770	0 986 478 464

96 017 878	0 986 478 751
96 047 276	0 986 478 142
96 054 779	0 986 478 140
96 070 525	0 986 478 046
96 099 616	0 986 478 125

RENAULT

40 202 00 03R	0 986 479 445
40 202 00 03R	0 986 479 446
44 06 0CY 025	0 986 487 734

44 06 000 02R	0 986 494 127
50 00 388 057	0 986 479 488
50 10 260 603	0 986 479 342
50 10 260 604	0 986 479 343
60 01 547 630	0 986 487 585

60 01 547 683	0 986 479 164
60 01 547 684	0 986 479 165
60 01 549 803	0 986 494 197
60 20 013 026	0 986 479 011
60 25 170 698	0 986 487 076

60 25 304 079	0 986 478 305
60 25 370 305	0 986 487 749
60 25 370 306	1 987 475 222
60 25 370 406	0 986 478 305
77 00 302 128	0 986 478 745

77 00 314 064	0 986 479 001
77 00 314 107	0 986 478 970
77 00 419 824	0 986 477 061
77 00 419 824	0 986 477 112
77 00 428 821	0 986 477 120

77 00 428 821	0 986 477 122
77 00 502 515	0 986 478 103
77 00 561 367	0 986 478 113
77 00 649 109	0 986 478 111
77 00 649 850	0 986 478 112

77 00 677 045	0 986 478 104
77 00 704 705	0 986 478 105
77 00 710 511	0 986 477 067
77 00 710 644	0 986 478 280
77 00 715 081	0 986 478 270

77 00 715 165	0 986 478 289
77 00 715 166	0 986 478 390
77 00 716 947	0 986 478 273
77 00 751 165	0 986 478 289
77 00 752 363	0 986 477 061

77 00 754 286	0 986 478 274
77 00 754 287	0 986 478 275
77 00 756 572	0 986 478 276
77 00 757 354	0 986 477 117
77 00 758 195	0 986 478 391

77 00 758 901	0 986 478 278
77 00 764 192	0 986 478 424
77 00 764 193	0 986 478 279
77 00 767 602	0 986 478 280
77 00 771 653	0 986 477 108

77 00 780 078	0 986 478 557
77 00 780 892	0 986 478 124
77 00 783 030	0 986 477 061
77 00 783 030	0 986 477 112
77 00 783 031	0 986 477 108

77 00 783 392	0 986 477 076
77 00 783 392	0 986 477 117
77 00 793 047	0 986 478 719
77 00 793 631	0 986 478 289
77 00 795 751	0 986 478 719

77 00 800 002	0 986 478 611
77 00 800 003	0 986 478 757
77 00 800 004	0 986 478 758
77 00 801 101	0 986 478 719
77 00 802 231	0 986 478 734

77 00 802 232	0 986 478 598
77 00 802 233	0 986 478 864
77 00 805 006	0 986 478 866
77 00 805 006	0 986 479 281
77 00 805 148	0 986 478 442

77 00 813 549	0 986 478 124
77 00 818 346	0 986 477 077
77 00 820 816	0 986 477 121
77 00 827 866	0 986 477 120
77 00 827 866	0 986 477 122

77 00 829 553	0 986 478 557
77 00 830 283	0 986 478 734
77 00 839 322	0 986 477 120
77 00 840 711	0 986 477 121
77 00 842 131	0 986 478 124

77 01 004 720	1 987 475 103
77 01 010 665	1 987 475 030
77 01 201 064	1 987 475 020
77 01 201 205	0 986 487 080
77 01 201 208	0 986 487 283

77 01 201 209	0 986 487 283
77 01 201 210	0 986 487 020
77 01 201 213	0 986 487 319
77 01 201 214	0 986 487 284
77 01 201 216	0 986 487 437

77 01 201 218	0 986 487 365
77 01 201 219	0 986 487 076
77 01 201 219	0 986 487 381
77 01 201 221	0 986 487 541
77 01 201 225	0 986 487 081

77 01 201 226	0 986 487 081
77 01 201 227	0 986 487 089
77 01 201 296	0 986 478 757
77 01 201 381	0 986 487 541
77 01 201 479	0 986 487 076

77 01 201 479	0 986 487 381
77 01 201 482	0 986 487 020
77 01 201 533	1 987 475 152
77 01 201 551	1 987 475 053
77 01 201 555	0 986 487 319

77 01 201 617	0 986 487 547
77 01 201 618	1 987 475 074
77 01 201 674	0 986 487 089
77 01 201 687	1 987 475 100
77 01 201 688	1 987 475 100

77 01 201 823	1 987 475 099
77 01 201 987	1 987 474 135
77 01 202 141	1 987 474 197
77 01 202 205	0 986 487 332
77 01 202 287	0 986 487 275

77 01 202 288	0 986 487 084
77 01 202 347	1 987 475 116
77 01 202 380	1 987 475 051
77 01 202 381	0 986 487 076
77 01 202 384	0 986 487 076

77 01 202 480	1 987 474 177
77 01 202 542	0 986 487 272
77 01 202 550	1 987 475 101
77 01 202 598	0 986 487 332
77 01 202 820	0 986 487 272

77 01 202 898	0 986 487 084
77 01 202 899	0 986 487 084
77 01 202 900	0 986 487 332
77 01 202 900	0 986 487 378
77 01 202 901	0 986 487 020

77 01 202 919	0 986 487 289
77 01 202 921	0 986 487 076
77 01 202 922	0 986 487 541
77 01 202 923	0 986 487 283
77 01 202 957	0 986 487 284

77 01 202 958	0 986 487 357
77 01 202 963	0 986 487 080
77 01 202 964	0 986 487 365
77 01 202 967	0 986 487 275
77 01 203 216	0 986 487 084

77 01 203 545	0 986 487 076
77 01 203 546	1 987 475 051
77 01 203 563	0 986 487 076
77 01 203 716	0 986 487 013
77 01 203 716	0 986 487 076

77 01 203 979	0 986 487 585
77 01 203 980	1 987 475 256
77 01 204 216	0 986 487 084
77 01 204 228	0 986 478 124
77 01 204 262	1 987 474 195

77 01 204 268	0 986 487 272
77 01 204 281	0 986 478 113
77 01 204 282	0 986 478 105
77 01 204 283	0 986 478 270
77 01 204 285	0 986 478 273

77 01 204 286	0 986 478 276
77 01 204 288	0 986 478 424
77 01 204 293	0 986 478 557
77 01 204 294	0 986 478 557
77 01 204 295	0 986 478 611

77 01 204 296	0 986 478 757
77 01 204 297	0 986 478 758
77 01 204 298	0 986 478 719
77 01 204 300	0 986 478 598
77 01 204 301	0 986 478 864

77 01 204 302	0 986 478 866
77 01 204 303	0 986 478 442
77 01 204 304	0 986 478 124
77 01 204 305	0 986 478 734
77 01 204 495	0 986 478 598

77 01 204 496	0 986 478 864
77 01 204 499	0 986 478 598
77 01 204 523	0 986 478 557
77 01 204 637	0 986 487 547
77 01 204 638	0 986 487 547

77 01 204 639	0 986 487 547
77 01 204 828	0 986 478 124
77 01 204 835	0 986 487 550
77 01 204 836	0 986 477 120
77 01 204 836	0 986 477 122

77 01 204 840	1 987 475 101
77 01 204 883	0 986 487 528
77 01 204 885	1 987 475 257
77 01 204 901	0 986 478 557
77 01 204 954	0 986 478 278

77 01 204 978	0 986 487 332
77 01 205 051	0 986 487 020
77 01 205 228	0 986 478 598
77 01 205 229	0 986 478 864
77 01 205 230	0 986 478 590

77 01 205 231	0 986 478 734
77 01 205 290	0 986 487 525
77 01 205 339	0 986 487 528
77 01 205 517	0 986 487 699
77 01 205 518	1 987 475 253



77 01 205 523	0 986 487 570
77 01 205 524	1 987 475 264
77 01 205 653	0 986 478 124
77 01 205 689	0 986 487 332
77 01 205 720	0 986 487 585

77 01 205 756	1 987 475 162
77 01 205 758	0 986 487 556
77 01 205 840	0 986 478 598
77 01 205 841	0 986 478 864
77 01 205 842	0 986 478 590

77 01 205 843	0 986 478 734
77 01 205 844	0 986 478 611
77 01 205 845	0 986 478 757
77 01 205 846	0 986 478 758
77 01 206 118	0 986 478 590

77 01 206 198	0 986 478 734
77 01 206 328	0 986 479 108
77 01 206 328	0 986 479 270
77 01 206 339	0 986 478 124
77 01 206 427	1 987 475 294

77 01 206 429	0 986 487 627
77 01 206 613	0 986 479 743
77 01 206 614	0 986 478 743
77 01 206 673	0 986 479 109
77 01 206 831	0 986 479 198

77 01 206 845	0 986 479 078
77 01 206 846	0 986 479 144
77 01 206 924	0 986 478 971
77 01 206 924	0 986 479 272
77 01 206 962	0 986 487 585

77 01 206 972	1 987 475 256
77 01 207 178	0 986 487 627
77 01 207 227	0 986 479 195
77 01 207 266	0 986 487 550
77 01 207 357	0 986 478 972

77 01 207 378	0 986 479 199
77 01 207 555	0 986 487 570
77 01 207 556	0 986 487 699
77 01 207 795	0 986 479 103
77 01 207 823	0 986 479 007

77 01 207 823	0 986 479 278
77 01 207 829	0 986 478 590
77 01 207 897	0 986 479 209
77 01 207 898	0 986 479 196
77 01 207 898	0 986 479 274

77 01 208 054	0 986 478 866
77 01 208 063	0 986 487 699
77 01 208 073	0 204 104 019
77 01 208 111	0 986 487 585
77 01 208 112	0 204 072 821

77 01 208 230	0 986 479 108
77 01 208 230	0 986 479 277
77 01 208 252	0 986 479 164
77 01 208 356	1 987 475 300
77 01 208 357	0 986 487 668

77 01 348 825	0 986 487 080
77 01 349 648	0 986 487 084
77 01 349 649	0 986 487 275
77 01 349 705	0 986 487 541
77 01 349 706	0 986 487 076

77 01 349 744	0 986 487 020
77 01 349 780	0 986 487 272
77 01 349 928	0 986 487 076
77 01 458 174	0 986 487 076
77 01 458 174	0 986 487 381

77 01 458 176	0 986 487 319
77 01 460 326	0 986 477 094
77 01 466 540	0 986 478 103
77 01 466 541	0 986 478 051
77 01 466 542	0 986 478 112

77 01 466 543	0 986 478 111
77 01 466 781	0 986 478 274
77 01 466 782	0 986 478 275
77 01 467 115	0 986 478 104
77 01 467 306	0 986 478 390

77 01 467 307	0 986 478 289
77 01 467 954	0 986 478 278
77 01 467 955	0 986 478 279
77 01 472 838	0 986 478 744
77 01 713 008	0 986 478 744

77 01 713 008	0 986 479 273
77 11 130 076	0 986 479 144
77 11 130 076	0 986 479 271
79 10 007 463	0 986 478 051
82 00 007 121	0 986 479 743

82 00 007 122	0 986 478 743
82 00 010 519	0 986 479 078
82 00 018 407	0 986 478 971
82 00 018 407	0 986 479 280
82 00 019 581	0 986 479 198

82 00 177 023	0 986 479 199
82 00 177 024	0 986 478 972
82 00 228 610	0 986 479 144
82 00 228 610	0 986 479 271
82 00 242 317	0 986 479 199

82 00 244 108	0 986 479 083
82 00 244 108	0 986 479 276
82 00 367 094	0 986 478 744
82 00 367 094	0 986 479 273
82 00 570 191	0 986 478 972

82 00 570 677	0 986 479 199
82 00 649 353	0 986 479 276
82 00 663 193	0 986 479 280

SEAT

RF1 650 025 0	0 986 478 063
RF1 650 025 3	0 986 478 063
SE 021 165 002 A	0 986 478 794

SE 022 165 002 A	0 986 478 063
SE 022 165 002 B	0 986 478 740
SE 022 165 201 A	0 986 477 055
SE 028 165 299 B	0 986 487 030
000 413 901 0	0 986 478 063

000 420 831 1	0 986 478 063
002 415 019	0 986 478 859
1H0 615 601	0 986 478 894
1H0 698 545	1 987 475 110
1H0 698 545 A	1 987 475 110

1H0 698 545 B	1 987 475 110
1J0 615 301 C	0 986 478 867
1J0 615 301 D	0 986 478 853
1J0 615 301 E	0 986 478 852
1J0 615 301 M	0 986 478 852

1J0 615 601	0 986 478 868
1J0 615 601 C	0 986 478 868
1J0 698 525	0 986 487 555
2D0 615 301 A	0 986 478 849
2D0 615 601	0 986 478 863

321 698 545	1 987 475 004
357 615 601	0 986 478 331
357 615 601 A	0 986 478 332
357 615 601 B	0 986 478 332
6U0 615 301	0 986 478 859

7M0 615 301 G	0 986 478 893
7M0 615 601 A	0 986 478 421
7M0 615 601 B	0 986 478 421
701 615 301 F	0 986 478 846
701 615 301 G	0 986 478 870

701 615 601 A	0 986 478 871
8D0 615 601 A	0 986 478 888
8E0 615 301 A	0 986 478 872
8E0 615 301 B	0 986 478 869

SKODA

002 415 019	0 986 478 859
1H0 615 601	0 986 478 894
1H0 698 545 A	1 987 475 110

1H0 698 545 B	1 987 475 110
1J0 615 301 C	0 986 478 867
1J0 615 301 D	0 986 478 853
1J0 615 301 E	0 986 478 852
1J0 615 301 M	0 986 478 852

1J0 615 601	0 986 478 868
1J0 615 601 C	0 986 478 868
1J0 615 601 D	0 986 478 481
1J0 698 525	0 986 487 555
1K0 615 301 AA	0 986 479 058

113 330 140	0 986 487 321
113 340 141	0 986 487 321
113 430 210	0 986 478 775
115 330 149	0 986 487 326
115 330 981	1 987 475 110

115 330 982	1 987 475 110
115 430 210	0 986 478 776
115 430 211	0 986 478 776
2D0 615 301 A	0 986 478 849
2D0 615 601	0 986 478 863

4B0 615 601 B	0 986 478 480
6N0 615 601 A	0 986 478 492
6U0 501 615 B	0 986 477 041
6U0 615 301	0 986 478 859
7M0 615 301 G	0 986 478 893

7M0 615 601 A	0 986 478 421
7M0 615 601 B	0 986 478 421
701 615 301 F	0 986 478 846
701 615 301 G	0 986 478 870
701 615 601 A	0 986 478 871

8D0 615 601 A	0 986 478 888
8E0 615 301 A	0 986 478 872
8E0 615 301 B	0 986 478 869
8L0 615 301	0 986 478 467
8L0 615 601	0 986 478 482

SUBARU

25178 GA300	0 986 487 442
25178 GA310	0 986 487 343
25431 GA170	0 986 478 287

25431 GA171	0 986 478 287
25431 GA180	0 986 478 558
25431 GA200	0 986 478 287
25431 GA210	0 986 478 558
26290 TA080	0 986 487 682

26298 AA010	0 986 487 463
26298 AA020	0 986 487 681
26300 AE060	0 986 478 977
26300 FE010	0 986 478 977
26300 SA000	0 986 478 977

26300 SA001	0 986 478 977
26310 AA021	0 986 478 293
26310 AA031	0 986 478 293
26310 AA032	0 986 478 293
26310 AA040	0 986 478 799

26310 AA050	0 986 478 799
26310 AA051	0 986 478 799
26310 AA091	0 986 478 799
26310 AA092	0 986 479 147
26310 AA111	0 986 478 800

26310 AA120	0 986 479 147
26310 AA121	0 986 479 147
26310 AC040	0 986 478 977
26310 AC060	0 986 478 293
26694 FG010	0 986 487 739

◀ SUBARU

26698 AC000	0 986 487 681
36310 AA091	0 986 478 799
36310 AA111	0 986 478 800
55200 80E10	0 986 424 804
55311 80F01	0 986 478 721

62530 1111	0 986 487 408
72517 8140	0 986 487 473
72517 8170	0 986 487 269
72517 8480	0 986 487 269
72517 8481	0 986 487 269

72517 8520	0 986 487 473
72543 1070	0 986 478 782
72543 1090	0 986 478 285
72543 1092	0 986 478 285
72543 1150	0 986 478 392

72543 1290	0 986 478 292
72543 1300	0 986 478 392
72543 1301	0 986 478 392
72543 1312	0 986 478 392

SUZUKI

00000 A00902	0 986 487 013
43511-60G00	0 986 477 141
43511-60G10	0 986 477 141

43511-83E50	0 986 477 127
52200-70820	0 986 487 324
52200-80840	0 986 487 324
52210-52010	0 986 487 205
52210-73041	0 986 487 404

52210-77300	0 986 487 324
52210-77301	0 986 487 324
52210-77370	0 986 487 324
52210-79240	0 986 487 324
52210-79241	0 986 487 324

52210-79260	0 986 487 324
52210-80040	0 986 487 324
52210-80050	0 986 487 204
52210-85400	0 986 487 324
53200-56810	0 986 487 470

53200-56821	0 986 487 470
53200-60810	0 986 487 425
53200-60820	0 986 487 379
53200-60821	0 986 487 430
53200-60841	0 986 487 436

53200-60880	0 986 487 677
53200-62J01	0 986 487 665
53200-62J01	0 986 487 695
53200-65D00	0 986 487 616
53200-65D01	0 986 487 616

53200-65D10	0 986 487 616
53200-65D11	0 986 487 616
53200-65J00	0 986 487 736
53200-65J01	0 986 487 736
53200-69G11	0 986 487 436

53200-70800	0 986 487 678
53200-70820	0 986 487 593
53200-76G00	0 986 487 676
53200-76G10	0 986 487 676
53200-76G20	0 986 487 676

53200-76G31	0 986 487 676
53200-76G50	0 986 487 676
53200-76G51	0 986 487 676
53200-77810	0 986 487 594
53200-77811	0 986 487 594

53200-79J00	0 986 487 731
53200-79J01	0 986 487 731
53200-80810	0 986 487 204
53200-80830	0 986 487 268
53200-81A01	0 986 487 440

53200-81A11	0 986 487 440
53200-84E00	0 986 487 707
53200-86G00	0 986 487 707
53201-70A00	0 986 487 531
53210-56B30	0 986 487 470

53210-60A00	0 986 487 425
53210-60A20	0 986 487 425
53210-60B00	0 986 487 379
53210-60B00	0 986 487 430
53210-60B10	0 986 487 430

53210 601310	0 986 487 430
53210-70C00	0 986 487 436
53210-78410	0 986 487 345
53210-80050	0 986 487 204
53210-82030	0 986 487 314

53210-82031	0 986 487 314
53210-83040	0 986 487 268
53210-83041	0 986 487 268
53210-84010	0 986 487 269
53210-85200	0 986 487 427

53210-85201	0 986 487 427
53210-85260	0 986 487 427
53210-86000	0 986 487 314
53210-86040	0 986 487 314
55200-80E10	0 204 100 544

55200-80E10	0 986 424 804
55211-160A00	0 986 478 838
55211-56B00	0 986 478 422
55211-60A00	0 986 478 539
55211-65D01	0 986 479 486

55211-65D10	0 986 478 839
55211-65D11	0 986 478 839
55211-65D12	0 986 478 839
55211-65D13	0 986 478 839
55211-80000	0 986 478 377

55311-M75F00	0 986 479 241
55311-60B11	0 986 478 376
55311-60B20	0 986 478 721
55311-60B30	0 986 478 721
55311-60B40	0 986 478 540

55311-61G00	0 986 478 450
55311-61G01	0 986 478 450
55311-62G00	0 986 478 841
55311-62G01	0 986 478 841
55311-62J00	0 986 479 308

55311-75F00	0 986 479 241
55311-79J01	0 986 479 403
55311-80F00	0 986 478 721
55311-80F01	0 986 478 721
55311-80F02	0 986 478 721

55311-80G00	0 986 478 984
55311-80G02	0 986 478 984
55311-83E00	0 986 478 729
55311-84E01	0 986 479 370
55311-86G02	0 986 479 370

55511-82000	0 986 478 376
55511-86030	0 986 478 379
55511-86031	0 986 478 379
55810-62J20	0 986 494 160
55810-79J00	0 986 494 129

55810-83E00	0 204 100 544
-------------	----------------------

TALBOT

00 131 569 14	0 986 478 121
00 135 458 00	0 986 487 076
00 175 824 00	0 986 487 449

00 175 825 00	0 986 487 449
00 175 916 00	0 986 487 076
00 175 916 00	0 986 487 089
00 175 917 00	0 986 487 413
00 254 072 14	0 986 478 801

00 430 233 14	0 986 478 121
25 407 214	0 986 478 801
3701 40	0 986 478 091
4236 14	0 986 487 081
4238 33	0 986 487 403

4238 46	0 986 487 020
4238 96	0 986 487 456
4238 99	0 986 487 128
4241 G3	0 986 487 346
4241 H6	0 986 487 749

4241 H7	0 986 487 545
4241 J4	0 986 487 549
4241 J8	0 986 487 552
4241 K5	0 986 487 568
4246 A0	0 986 478 234

4246 B1	0 986 478 268
4246 B2	0 986 478 091
4246 B7	0 986 478 801
4246 E4	0 986 478 121
4246 H2	0 986 478 094

4246 H3	0 986 478 234
4246 R5	0 986 478 268
4246 42	0 986 478 091
4246 61	0 986 478 092
4246 63	0 986 478 051

4246 70	0 986 478 094
4246 97	0 986 478 268
4246 98	0 986 478 094
4257 9G	0 986 478 121
5883 4Y	0 986 478 121

78 515 310 00	0 986 478 091
79 100 073 77	0 986 478 094
79 100 073 78	0 986 478 092
79 100 074 63	0 986 478 051
91 502 484	0 986 477 097

TOYOTA

04465 0D050	0 986 494 101
04465 0H020	0 986 494 065
04465 0W140	0 986 494 196

04465 05130	0 986 424 831
04465 05130	0 986 494 054
04465 05170	0 986 424 831
04465 05170	0 986 494 054
04465 05210	0 986 424 831

04465 05210	0 986 494 054
04465 05221	0 986 424 831
04465 05221	0 986 494 054
04465 13030	0 986 424 808
04465 2B010	0 986 424 808

04465 2B030	0 986 424 808
04465 2B040	0 986 424 808
04465 20500	0 986 424 808
04465 20540	0 986 424 808
04465 20570	0 986 424 808

04465 35250	0 986 494 153
04465 35290	0 986 494 153
04465 42140	0 986 494 174
04465 52200	0 986 494 101
04465 52260	0 986 494 198

04465 52270	0 986 494 196
04465 60270	0 986 494 153
04466 0D010	0 986 494 130
04466 42060	0 986 494 154
04494 20101	0 986 487 294

04494 60020	0 986 487 468
04495 0D010	0 986 487 665
04495 0D020	0 986 487 665
04495 0H010	0 986 487 665
04495 0H010	0 986 487 695

04495 02020	0 986 487 586
04495 02070	0 986 487 713
04495 02120	0 986 487 713
04495 02180	0 986 487 713
04495 02190	0 986 487 713
04495 05010	0 986 487 586
04495 05020	0 986 487 572
04495 05040	0 986 487 679
04495 10041	0 986 487 349
04495 10056	0 986 487 390
04495 10071	0 986 487 298
04495 10110	0 986 487 298
04495 10120	0 986 487 474
04495 12010	0 986 487 025
04495 12020	0 986 487 203
04495 12050	0 986 487 025
04495 12060	0 986 487 025
04495 12061	0 986 487 025
04495 12070	0 986 487 294
04495 12080	0 986 487 277
04495 12081	0 986 487 277
04495 12082	0 986 487 277
04495 12083	0 986 487 277
04495 12090	0 986 487 277
04495 12091	0 986 487 277
04495 12110	0 986 487 422
04495 12111	0 986 487 422
04495 12141	0 986 487 453
04495 12181	0 986 487 453
04495 12210	0 986 487 422
04495 12220	0 986 487 203
04495 14010	0 986 487 025
04495 14030	0 986 487 294
04495 14040	0 986 487 448
04495 16010	0 986 487 390
04495 16020	0 986 487 239
04495 16021	0 986 487 239
04495 16030	0 986 487 349
04495 16031	0 986 487 349
04495 20030	0 986 487 294
04495 20031	0 986 487 294
04495 20050	0 986 487 294
04495 20090	0 986 487 203
04495 20091	0 986 487 203
04495 20092	0 986 487 203
04495 20100	0 986 487 203
04495 20101	0 986 487 203
04495 20120	0 986 487 203
04495 20121	0 986 487 203
04495 20150	0 986 487 203
04495 22040	0 986 487 448
04495 22060	0 986 487 448
04495 26020	0 986 487 377
04495 26040	0 986 487 292
04495 26060	0 986 487 414

04495 26061	0 986 487 414
04495 26080	0 986 487 290
04495 26121	0 986 487 290
04495 26150	0 986 487 361
04495 26210	0 986 487 743
04495 26220	0 986 487 743
04495 26230	0 986 487 743
04495 28071	0 986 487 290
04495 32010	0 986 487 203
04495 32011	0 986 487 203
04495 32030	0 986 487 203
04495 32031	0 986 487 203
04495 33020	0 986 487 424
04495 33020	0 986 487 489
04495 35031	0 986 487 292
04495 35051	0 986 487 292
04495 35052	0 986 487 292
04495 35090	0 986 487 292
04495 35100	0 986 487 292
04495 35131	0 986 487 290
04495 35151	0 986 487 414
04495 35170	0 986 487 744
04495 35230	0 986 487 414
04495 35240	0 986 487 743
04495 40021	0 986 487 290
04495 42010	0 986 487 424
04495 42030	0 986 487 424
04495 42040	0 986 487 424
04495 42070	0 986 487 424
04495 42080	0 986 487 692
04495 44010	0 986 487 588
04495 52020	0 986 487 589
04495 52040	0 986 487 589
04495 60010	0 986 487 354
04495 60011	0 986 487 354
04495 60031	0 986 487 354
04495 60051	0 986 487 354
04495 60060	0 986 487 354
04495 60070	0 986 487 354
04497 12010	0 986 487 025
04497 12030	0 986 487 025
04497 12040	0 986 487 025
04497 14010	0 986 487 294
04497 14020	0 986 487 294
04497 14030	0 986 487 294
04497 16020	0 986 487 239
04497 16021	0 986 487 239
04497 20070	0 986 487 203
04497 20071	0 986 487 203
04497 20072	0 986 487 203
04497 20080	0 986 487 203
04497 20081	0 986 487 203
04497 20090	0 986 487 203
04497 20091	0 986 487 203
04497 20100	0 986 487 203

04497 32010	0 986 487 203
04497 32011	0 986 487 203
42431 0D050	0 986 479 087
42431 0D060	0 986 479 360
42431 0F010	0 204 173 007
42431 0F010	0 986 479 448
42431 0H010	0 986 477 148
42431 02070	0 986 479 086
42431 02071	0 986 479 086
42431 02080	0 986 479 149
42431 02081	0 986 479 149
42431 02082	0 986 479 149
42431 05020	0 986 477 140
42431 05030	0 986 479 242
42431 12090	0 986 478 559
42431 12120	0 986 478 559
42431 12130	0 986 477 090
42431 12150	0 986 479 335
42431 12180	0 986 477 090
42431 12210	0 986 479 087
42431 12250	0 986 479 087
42431 12260	0 986 479 418
42431 14100	0 986 478 443
42431 14110	0 986 478 443
42431 14120	0 986 478 443
42431 20080	0 986 477 082
42431 20090	0 986 478 560
42431 20090	0 986 479 483
42431 20160	0 986 478 560
42431 20160	0 986 479 483
42431 20190	0 986 477 139
42431 20200	0 986 479 336
42431 20250	0 986 477 090
42431 20300	0 986 479 336
42431 20320	0 986 478 560
42431 20430	0 986 479 243
42431 28090	0 986 479 200
42431 28091	0 986 479 200
42431 28120	0 986 479 200
42431 30140	0 986 479 023
42431 30190	0 986 479 023
42431 30240	0 986 479 023
42431 33030	0 986 479 337
42431 40080	0 986 479 023
42431 42040	0 986 479 338
42431 42041	0 986 479 338
42431 42060	0 986 479 419
42431 50040	0 986 479 023
42431 52020	0 986 477 138
42431 52021	0 986 477 138
42431 52050	0 986 479 087
42431 52080	0 986 479 420
42431 53010	0 986 479 339
42431 53011	0 986 479 339
42431 60200	0 986 479 421

42431 60201	0 986 479 421
43512 YE010	0 986 478 397
43512 0D010	0 986 478 582
43512 0D010	0 986 479 244
43512 0D050	0 986 479 012
43512 0D059	0 986 479 012
43512 0D060	0 986 479 363
43512-0F010	0 204 173 008
43512 0F010	0 986 479 454
43512 0H010	0 986 479 239
43512 02070	0 986 479 085
43512 02070	0 986 479 422
43512 02071	0 986 479 422
43512 02080	0 986 479 245
43512 02081	0 986 479 245
43512 02180	0 986 479 425
43512 05010	0 986 478 858
43512 05020	0 986 479 490
43512 05030	0 986 478 451
43512 05040	0 986 479 340
43512 05050	0 986 479 423
43512 05070	0 204 173 009
43512 05070	0 986 479 423
43512 07020	0 986 478 632
43512 10040	0 986 478 177
43512 10050	0 986 478 177
43512 10060	0 986 479 441
43512 10070	0 986 478 290
43512 10090	0 986 479 417
43512 10160	0 986 478 491
43512 12020	0 986 478 779
43512 12021	0 986 478 779
43512 12022	0 986 478 779
43512 12100	0 986 478 180
43512 12110	0 986 478 180
43512 12140	0 986 478 661
43512 12160	0 986 478 222
43512 12230	0 986 478 506
43512 12250	0 986 478 385
43512 12290	0 986 478 385
43512 12300	0 986 478 385
43512 12320	0 986 478 385
43512 12330	0 986 478 385
43512 12340	0 986 478 385
43512 12440	0 986 478 385
43512 12480	0 986 478 385
43512 12500	0 986 478 506
43512 12550	0 986 478 578
43512 12670	0 986 479 341
43512 12690	0 986 479 425
43512 13021	0 986 479 245
43512 13022	0 986 479 245
43512 13030	0 986 479 084
43512 14080	0 986 478 795
43512 16030	0 986 478 221



◀ TOYOTA

43512 16031	0 986 478 221
43512 16070	0 986 478 438
43512 16080	0 986 478 585
43512 16120	0 986 478 438
43512 16130	0 986 478 585
43512 17130	0 986 479 012
43512 20080	0 986 478 395
43512 20100	0 986 478 383
43512 20110	0 986 478 383
43512 20120	0 986 478 396
43512 20150	0 986 478 383
43512 20180	0 986 478 395
43512 20190	0 986 478 724
43512 20260	0 986 478 857
43512 20270	0 986 478 396
43512 20280	0 986 478 724
43512 20310	0 986 478 385
43512 20360	0 986 478 725
43512 20380	0 986 478 725
43512 20390	0 986 478 541
43512 20400	0 986 478 541
43512 20470	0 986 478 584
43512 20480	0 986 478 584
43512 20500	0 986 479 490
43512 20580	0 986 478 584
43512 20590	0 986 478 583
43512 20700	0 986 478 584
43512 21010	0 986 478 584
43512 22060	0 986 478 803
43512 22260	0 986 479 426
43512 26040	0 986 478 397
43512 26070	0 986 478 397
43512 26090	0 986 478 452
43512 26120	0 986 479 427
43512 26140	0 986 478 693
43512 28020	0 986 478 398
43512 28050	0 986 478 106
43512 28051	0 986 478 106
43512 28060	0 986 478 441
43512 28100	0 986 478 631
43512 28110	0 986 478 441
43512 32020	0 986 478 723
43512 32040	0 986 478 723
43512 32090	0 986 478 295
43512 32110	0 986 478 723
43512 32180	0 986 478 295
43512 33020	0 986 478 726
43512 33040	0 986 478 632
43512 33041	0 986 478 632
43512 33042	0 986 478 632
43512 33043	0 986 478 632
43512 33050	0 986 478 726
43512 33060	0 986 478 632
43512 33090	0 986 478 632
43512 33100	0 986 478 968

43512 35070	0 986 478 304
43512 35180	0 986 478 397
43512 35190	0 986 478 453
43512 35200	0 986 478 629
43512 35210	0 986 478 698
43512 35260	0 986 478 397
43512 42010	0 986 478 490
43512 42030	0 986 479 111
43512 42031	0 986 479 111
43512 42032	0 986 479 111
43512 42040	0 986 479 428
43512 42050	0 986 479 428
43512 50100	0 986 479 429
43512 50110	0 986 479 485
43512 50111	0 986 479 485
43512 50112	0 986 479 485
43512 50160	0 986 AB6 389
43512 50220	0 986 AB6 389
43512 52020	0 986 478 582
43512 52020	0 986 479 244
43512 52040	0 986 479 012
43512 52050	0 986 478 582
43512 52050	0 986 479 244
43512 52090	0 986 479 012
43512 52120	0 986 479 430
43512 52130	0 986 479 431
43512 60040	0 986 478 384
43512 60060	0 986 478 304
43512 60090	0 986 478 580
43512 60150	0 986 479 304
43512 60151	0 986 479 304
43512 69015	0 986 478 384
43512 69016	0 986 478 384
43512 87101	0 986 478 661
43516 22010	0 986 479 433
46540 02020	0 986 487 713
46540 20020	0 986 487 680
46540 20030	0 986 487 602
46540 20040	0 986 487 680
46540 20050	0 986 487 602
46540 20060	0 986 487 680
46540 20070	0 986 487 680
46540 20080	0 986 487 679
46540 28010	0 986 487 615
46540 32020	0 986 487 679
46540 42020	0 986 487 734
46540 44010	0 986 487 615
46540 50010	0 986 487 615
46540 60050	0 986 487 728
46550 20020	0 986 487 680
46550 20030	0 986 487 602
46550 20040	0 986 487 680
46550 20050	0 986 487 602
46550 20060	0 986 487 680
46550 28010	0 986 487 615

46550 33020	0 986 487 680
46550 44010	0 986 487 615
46550 50010	0 986 487 615
46550 60060	0 986 487 728
46580 60060	0 986 487 727
46590 20020	0 986 487 680
46590 20030	0 986 487 602
46590 20040	0 986 487 680
46590 20050	0 986 487 602
46590 20060	0 986 487 680
46590 28010	0 986 487 615
46590 33020	0 986 487 680
46590 44010	0 986 487 615
46590 50010	0 986 487 615
47620 16020	0 986 487 239
47620 20230	0 986 487 203
47630 16010	0 986 487 239
VAUXHALL	
1605356	0 986 494 222
24444064	0 986 477 100
90007526	0 986 477 040
90008003	0 986 478 080
90008005	0 986 478 081
90008006	0 986 478 192
90065903	0 986 478 079
90077721	0 986 477 022
90086193	0 986 478 080
90086194	0 986 477 021
90111242	0 986 478 081
90121445	0 986 478 192
90135504	0 986 477 040
90168958	0 986 477 018
90182658	0 986 487 201
90222362	0 986 478 267
90223919	0 986 478 265
90250546	0 986 478 327
90271133	0 986 478 326
90271134	0 986 478 265
90271135	0 986 478 266
90272328	0 986 478 267
90295087	0 986 478 327
90297932	0 986 478 504
90344650	0 986 478 593
90348319	0 986 478 328
90375224	0 986 478 535
90392559	0 986 478 593
90421727	0 986 478 535
90421796	0 986 487 263
90444681	0 986 487 201
90445525	0 986 478 430
90487402	0 986 478 327

90495034	0 986 477 100
90509107	0 986 477 056
90509590	0 986 478 430
90511111	0 986 478 192
90512792	0 986 487 554
90512909	0 986 478 420
90512910	0 986 478 436
90542180	0 986 478 487
90542181	0 986 478 486
90542862	0 986 487 263
91024352	0 986 477 018
9111283	0 986 478 113
91159915	0 986 479 078
9117676	0 986 478 880
9117677	0 986 478 881
9117678	0 986 478 883
9200132	0 986 424 528
9280751	0 986 478 082
93176389	0 986 479 370
93179462	0 986 479 370
93188917	0 986 479 223
93188918	0 986 479 224
93189823	0 986 494 222
94172376	0 986 478 596
95175281	0 986 477 018
96175281	0 986 477 018
96179110	0 986 478 327
97034034	0 986 478 854
97034035	0 986 478 437
VW (VOLKSWAGEN)	
J43 512 351 80	0 986 478 397
J43 512 351 90	0 986 478 453
SE028165299B	0 986 487 030
002 415 019	0 986 478 859
022 165 201 A	0 986 477 055
1H0 501 615 A	0 986 477 041
1H0 609 525	0 986 487 270
1H0 609 526	0 986 487 270
1H0 609 527	0 986 487 270
1H0 609 528	0 986 487 270
1H0 615 109	0 986 468 870
1H0 615 301	0 986 478 542
1H0 615 301 A	0 986 478 542
1H0 615 601	0 986 478 894
1H0 698 151	0 986 468 870
1H0 698 520	0 986 487 270
1H0 698 520 X	0 986 487 270
1H0 698 525	0 986 487 270
1H0 698 525 B	0 986 487 270
1H0 698 525 V	0 986 487 270
1H0 698 525 X	0 986 487 270
1H0 698 545	1 987 475 110
1H0 698 545 A	1 987 475 110



1H0 698 545 B	1 987 475 110	171 609 525 A	0 986 487 002	2E0 906 206 B	1 987 473 038	291 609 531 F	0 986 487 494
1J0 609 617 B	0 986 477 152	171 609 526 A	0 986 487 002	2E0 906 206 C	1 987 473 037	291 609 531 H	0 986 487 494
1J0 615 301	0 986 478 867	171 609 527	0 986 487 000	2E0 906 206 G	1 987 473 036	291 609 532 F	0 986 487 494
1J0 615 301 C	0 986 478 867	171 609 527 B	0 986 487 311	211 609 533 B	0 986 487 429	291 609 532 H	0 986 487 494
1J0 615 301 D	0 986 478 853	171 609 527 D	0 986 487 003	211 609 537 N	0 986 487 535	291 609 617	0 986 477 035
1J0 615 301 E	0 986 478 852	171 609 527 F	0 986 487 002	211 609 537 S	0 986 487 535	291 698 527 GX	0 986 487 389
1J0 615 301 K	0 986 478 867	171 609 528 B	0 986 487 000	211 609 615	0 986 477 032	3A0 615 301	0 986 478 619
1J0 615 301 L	0 986 478 853	171 609 528 B	0 986 487 311	211 698 537 NX	0 986 487 535	3A0 615 301 A	0 986 478 619
1J0 615 301 M	0 986 478 852	171 609 528 D	0 986 487 003	211 698 537 SX	0 986 487 535	3A0 698 545	1 987 475 204
1J0 615 301 P	0 986 478 852	171 609 528 F	0 986 487 002	251 407 615 B	0 986 478 544	3A0 698 545 A	1 987 475 204
1J0 615 301 R	0 986 478 867	171 609 537	0 986 487 000	251 407 615 J	0 986 478 065	3B0 615 301 B	0 986 479 057
1J0 615 301 R	0 986 478 976	171 609 537 D	0 986 487 003	251 407 615 Q	0 986 478 544	3D0 698 451 A	0 986 494 119
1J0 615 301 S	0 986 478 867	171 615 269 A	1 987 474 136	251 407 615 R	0 986 478 065	311 405 583 A	0 986 478 126
1J0 615 301 S	0 986 478 976	171 615 269 C	1 987 474 136	251 407 617	0 986 478 136	311 609 537 B	0 986 487 362
1J0 615 601	0 986 478 868	171 615 270	1 987 474 136	251 407 617 A	0 986 478 136	311 609 537 E	0 986 487 362
1J0 615 601 C	0 986 478 868	171 615 270 A	1 987 474 136	251 407 617 D	0 986 478 224	311 609 537 G	0 986 487 362
1J0 615 601 D	0 986 478 481	171 698 527 DX	0 986 487 003	251 407 617 E	0 986 478 136	311 609 537 S	0 986 487 362
1J0 698 451 E	0 986 494 062	171 698 527 QX	0 986 487 000	251 407 617 F	0 986 478 224	321 615 301	0 986 478 011
1J0 698 525	0 986 487 555	171 698 537 DX	0 986 487 003	251 407 617 G	0 986 478 224	321 615 301 A	0 986 478 017
1J0 698 525 A	0 986 487 555	171 698 545	1 987 475 002	251 407 617 K	0 986 478 224	321 615 301 B	0 986 478 017
1J0 698 545	1 987 475 204	175 615 301	0 986 478 011	251 407 617 L	0 986 478 224	321 615 301 C	0 986 478 017
1K0 615 301 M	0 986 479 204	181 609 237 B	0 986 487 099	251 407 617 M	0 986 478 224	321 615 301 D	0 986 478 308
1K0 615 301 AA	0 986 479 058	191 501 615 A	0 986 477 041	251 407 617 N	0 986 478 224	321 698 151	0 986 468 870
1K0 615 301 AC	0 986 479 098	191 501 615 B	0 986 477 002	251 609 531 K	0 986 487 279	321 698 151 C	0 986 468 870
1K0 615 301 K	0 986 479 088	191 501 615 B	0 986 477 111	251 609 531 M	0 986 487 279	321 698 545	1 987 475 004
1K0 615 301 S	0 986 479 098	191 609 617	0 986 477 036	251 609 531 P	0 986 487 279	323 501 615	0 986 477 041
1K0 615 301 T	0 986 479 088	191 609 617 A	0 986 477 036	251 609 532 M	0 986 487 279	331 501 615	0 986 477 041
1K0 615 601 K	0 986 479 099	191 615 109 H	0 986 468 870	251 609 532 Q	0 986 487 279	331 609 527	0 986 487 342
1K0 615 601 L	0 986 479 155	191 615 269	1 987 474 137	251 609 615	0 986 477 033	331 609 527 B	0 986 487 342
1K0 615 601 M	0 986 479 247	191 615 270 A	1 987 474 137	251 609 631 P	0 986 487 279	357 501 615	0 986 477 042
1K0 615 601 N	0 986 479 303	191 615 601	0 986 478 331	251 698 531 EX	0 986 487 279	357 609 525 C	0 986 487 281
1K0 698 151 B	0 986 494 103	191 615 601 B	0 986 478 331	251 698 531 LX	0 986 487 279	357 609 526 C	0 986 487 281
1K0 698 451 B	0 986 424 824	191 698 151 H	0 986 468 870	251 698 545	1 987 475 006	357 609 527 E	0 986 487 281
1K0 698 451 B	0 986 494 062	191 698 151 K	0 986 468 870	281 609 527	0 986 487 193	357 609 528 E	0 986 487 281
1K0 698 451 E	0 986 424 824	2D0 609 538 A	0 986 487 611	281 609 527 GX	0 986 487 193	357 615 301	0 986 478 329
1K0 698 451 E	0 986 494 062	2D0 615 301 A	0 986 478 849	281 609 527 H	0 986 487 318	357 615 301 A	0 986 479 156
1K0 698 451 K	0 986 494 062	2D0 615 301 B	0 986 478 849	281 609 528	0 986 487 193	357 615 601	0 986 478 331
111 911 351 A	1 000 112 026	2D0 615 301 C	0 986 478 849	281 609 528 A	0 986 487 193	357 615 601 A	0 986 478 332
113 407 075	0 986 478 126	2D0 615 601	0 986 478 863	281 609 528 D	0 986 487 193	357 615 601 B	0 986 478 332
113 501 615 J	0 986 477 030	2D0 615 601 A	0 986 478 433	281 609 531 C	0 986 487 193	357 698 151 A	0 986 460 943
113 609 237 L	0 986 487 386	2D0 615 601 B	0 986 478 555	281 609 531 F	0 986 487 193	357 698 151 C	0 986 460 948
113 609 537 C	0 986 487 099	2D0 615 601 C	0 986 478 863	281 609 532 C	0 986 487 193	357 698 151 D	0 986 460 943
113 698 537 QX	0 986 487 099	2D0 615 601 D	0 986 478 433	281 609 532 F	0 986 487 193	357 698 525 C	0 986 487 281
115 330 149	0 986 487 326	2D0 698 525	0 986 487 610	281 609 617	0 986 477 034	357 698 525 CV	0 986 487 281
115 330 192	0 986 477 041	2D0 698 525 A	0 986 487 611	281 615 283	0 986 478 206	357 698 525 CX	0 986 487 281
115 331 140	0 986 487 270	2D0919351	1 987 474 969	281 615 283 A	0 986 478 138	357 698 525 X	0 986 487 270
115 430 210	0 986 478 776	2D0 919 351 A	1 987 473 007	281 615 283 B	0 986 478 138	4A0 615 301 B	0 986 478 545
115 430 211	0 986 478 776	2E0 615 301	0 986 479 294	281 615 301	0 986 478 206	4A0 615 301 C	0 986 478 546
115 430 212	0 986 479 491	2E0 615 601	0 986 479 296	281 698 527 AX	0 986 487 193	4A0 615 301 D	0 986 478 546
131 698 537 CX	0 986 487 367	2E0 615 601 A	0 986 479 295	281 698 527 GX	0 986 487 318	4A0 615 301 E	0 986 478 546
147 501 615 A	0 986 477 011	2E0 698 151	0 986 494 121	281 698 527 QX	0 986 487 193	4A0 615 601 A	0 986 478 132
171 501 615	0 986 477 002	2E0 698 151 A	0 986 494 194	281 698 527 X	0 986 487 193	4B0 615 301 A	0 986 479 057
171 501 615 A	0 986 477 002	2E0 698 451	0 986 494 122	291 609 527 F	0 986 487 494	4B0 615 301 B	0 986 479 157
171 501 615 B	0 986 477 002	2E0 698 451 A	0 986 494 122	291 609 528 B	0 986 487 494	4B0 615 601	0 986 478 461
171 501 615 B	0 986 477 111	2E0 698 525	0 986 487 720	291 609 528 F	0 986 487 494	4B0 615 601 A	0 986 478 704



811 609 527	0 986 487 002
811 609 527 A	0 986 487 002
811 609 527 E	0 986 487 536
811 609 528 E	0 986 487 536
811 615 301	0 986 478 010
811 615 301 C	0 986 478 010
811 698 525 A	0 986 487 536
811 698 525 AX	0 986 487 536
823 501 615 B	0 986 477 002
823 609 527	0 986 487 486
823 609 528	0 986 487 486
823 609 537	0 986 487 486
823 615 301	0 986 478 010
827 609 527	0 986 487 509
827 609 528	0 986 487 509
827 609 537	0 986 487 509
839 615 301	0 986 478 011
841 501 615 A	0 986 477 041
841 615 301	0 986 478 017
853 615 301 A	0 986 478 225
853 615 301 C	0 986 478 225
853 615 601	0 986 478 216
857 615 601	0 986 478 614
861 615 301	0 986 478 009
861 615 301 B	0 986 478 009
867 609 525	0 986 487 002
867 609 527	0 986 487 002
867 698 520 X	0 986 487 002
867 698 525	0 986 487 002
867 698 525 V	0 986 487 002
867 698 525 X	0 986 487 002
867 698 526 V	0 986 487 002
867 698 527 V	0 986 487 002
867 698 528 V	0 986 487 002
867 909 527	0 986 487 002
893 501 615	0 986 477 016
893 501 615 A	0 986 477 053
893 615 301	0 986 478 549
895 615 301	0 986 478 130
895 615 301 A	0 986 478 550
895 615 301 B	0 986 478 137
955 351 402 51	0 986 479 251



de

Inhalt

en

Content

fr

Contenu

it

Contenuto

es

Contenido

Angebot	Offer	Offre	Offerta	Oferta	
Faustsattel	Floating caliper	Etrier flottant	Pinza flottante	Pinza flotante	A 2
Tandem-Hauptzylinder	Tandem master cylinder	Maître-cylindre tandem	Cilindro maestro a tandem	Cilindro principal tándem	A 4
Radbremszylinder mit integriertem Regler (CRCI)	Wheel-brake cylinder with integrated regulator (CRCI)	Cylindre de roue correcteur intégré (CRCI)	Cilindretto del freno con regolatore integrato (CRCI)	Cilindros de rueda con regulador integrado (CRCI)	A 6
Hauptbremszylinder	Master cylinders	Maîtres-cylindres de freins	Pompa freni	Cilindro principal	A 8
Radbremszylinder	Wheel-brake cylinders	Cylindres de freins de roues	Cilindretti freno	Cilindros de rueda	A 10
Scheibenbrems-sättel	Disk-brake calipers	Etriers de freins à disques	Pinze freno a disco	Pinzas de freno de disco	A 12
Bremsschläuche	Brake hoses	Flexibles de frein	Tubi flessibili freno	Latiguillos de freno	A 16
Bremseile	Brake cables	Câbles de frein de stationnement	Cavi del freno di stazionamento	Cables de freno de mano	A 20

Verwendung	Applications	Affectations	Impiego	Aplicaciones	B 2
------------	--------------	--------------	---------	--------------	-----

Gegenüberstellung	Cross-reference	Table de correspondance	Comparazione	Equivalencias	
Bestellnummern	Part numbers	Références	Numeri d'ordinazione	Referencias	C 2

Bildzeichen- und Sonderfallerläuterungen siehe Katalogende.

See last pages for Pictogram and Special cases explanations.

Signification des pictogrammes et des codes spécifiques voir aux dernières pages.

Per il significato dei pittogrammi e dei casi particolari vedere le ultime pagine.

Abreviaturas, casos especiales y aclaraciones sobre los pictogramas mirar al final del catálogo.



**Häufigste Bauart:
Faustsattel**

Dieser Bremsattel wandelt den hydraulischen Druck um und erzeugt damit die Anpresskraft der Bremsbeläge an die Scheiben. In einem beweglich gelagerten Gehäuse presst der Kolben dabei den inneren Bremsbelag direkt auf die Scheibe. Die erzeugte Reaktionskraft verschiebt das Gehäuse und drückt indirekt auch den äußeren Belag gegen die Scheibe. An der Hinterachse wird häufig eine Faustsattelbremse mit integrierter Feststellbremse eingesetzt.

**Most common design:
Floating caliper**

This brake caliper converts the hydraulic pressure and so generates the press force of the brake pads on the disks. Inside a flexibly mounted housing, the piston presses the inner brake pad directly onto the disk. The reaction force generated moves the housing and also indirectly presses the outer pad against the disk. A floating caliper with integrated parking brake is often used on the rear axle.

**Type le plus fréquent:
Etrier flottant**

Cet étrier de frein convertit la pression hydraulique et produit la force de pression des garnitures de frein sur les disques. A l'intérieur d'un boîtier mobile, le piston pousse la garniture de frein intérieure directement contre le disque. La force de réaction produite déplace le boîtier et pousse indirectement la garniture extérieure également contre le disque. On utilise très souvent sur l'essieu arrière un frein à étrier flottant avec frein de stationnement intégré.

**Tipo costruttivo più frequente:
Pinza flottante**

Questa pinza freno trasforma la pressione idraulica e genera in questo modo la forza di spinta delle pastiglie contro i dischi. All'interno di una scatola a supporto mobile il pistone spinge la pastiglia interna del freno direttamente sul disco. La forza di reazione generata sposta la scatola e spinge indirettamente anche la pastiglia esterna contro il disco. Sull'assale posteriore viene frequentemente impiegato un freno a pinza flottante con freno di stazionamento integrato.

**Tipo de ejecución más frecuente
Pinza flotante**

Esta pinza de freno transforma la presión hidráulica y genera así la fuerza de apriete de las pastillas de freno en los discos. En una carcasa alojada en forma móvil, el émbolo apreta en ello la pastilla de freno interior directamente sobre el disco. La fuerza de reacción generada, desplaza la carcasa y apreta indirectamente también la pastilla exterior contra el disco. En el eje trasero se aplica frecuentemente un freno de pinza flotante con freno de estacionamiento integrado.

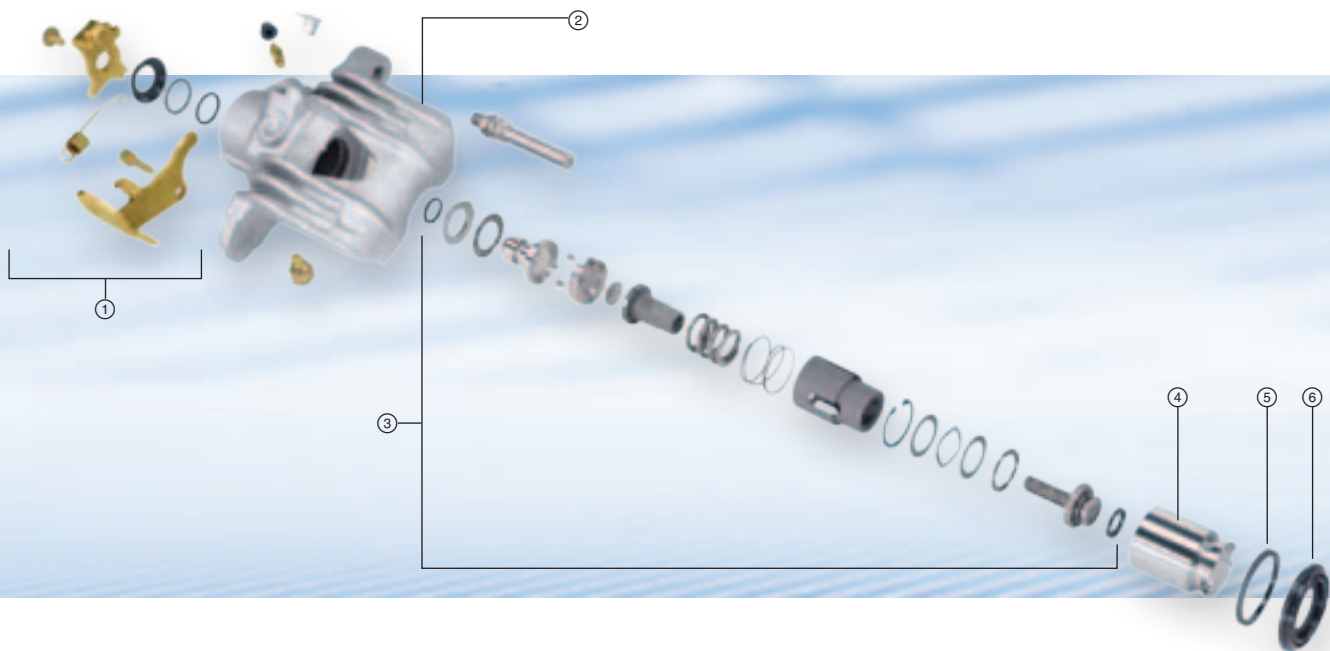

Bremssattel mit integrierter Feststellbremse

- ① Betätigung Handbremse
- ② Bremssattelgehäuse
- ③ Nachstelleinheit für Handbremsbetätigung
- ④ Kolben
- ⑤ Kolbendichtung
- ⑥ Staubschutzmanschette

Brake caliper with integrated parking brake

- ① Handbrake operation
- ② Brake-caliper housing
- ③ Adjuster unit for handbrake operation
- ④ Piston
- ⑤ Piston seal
- ⑥ Dust-guard sleeve

Etrier de frein avec frein de stationnement intégré

- ① Commande du frein à main
- ② Boîtier de l'étrier de frein
- ③ Unité de rattrapage du jeu de la commande du frein à main
- ④ Piston
- ⑤ Joint de piston
- ⑥ Pare-poussière

Pinza freno con freno di stazionamento integrato

- ① Azionamento freno a mano
- ② Scatola pinza freno
- ③ Unità di regolazione per azionamento freno a mano
- ④ Pistoncino
- ⑤ Guarnizione del pistoncino
- ⑥ Cuffia parapolvere

Pinza de freno con freno de estacionamiento integrado

- ① Accionamiento del freno
- ② Carcasa de la pinza de freno
- ③ Unidad de reajuste para el accionamiento de freno de mano
- ④ Embolo
- ⑤ Junta de émbolo
- ⑥ Guardapolvo

de

**Tandem-
Hauptzylinder**

en

**Tandem
master cylinder**

fr

**Maître-cylindre
tandem**

it

**Cilindro maestro
a tandem**

es

**Cilindro principal
tándem**

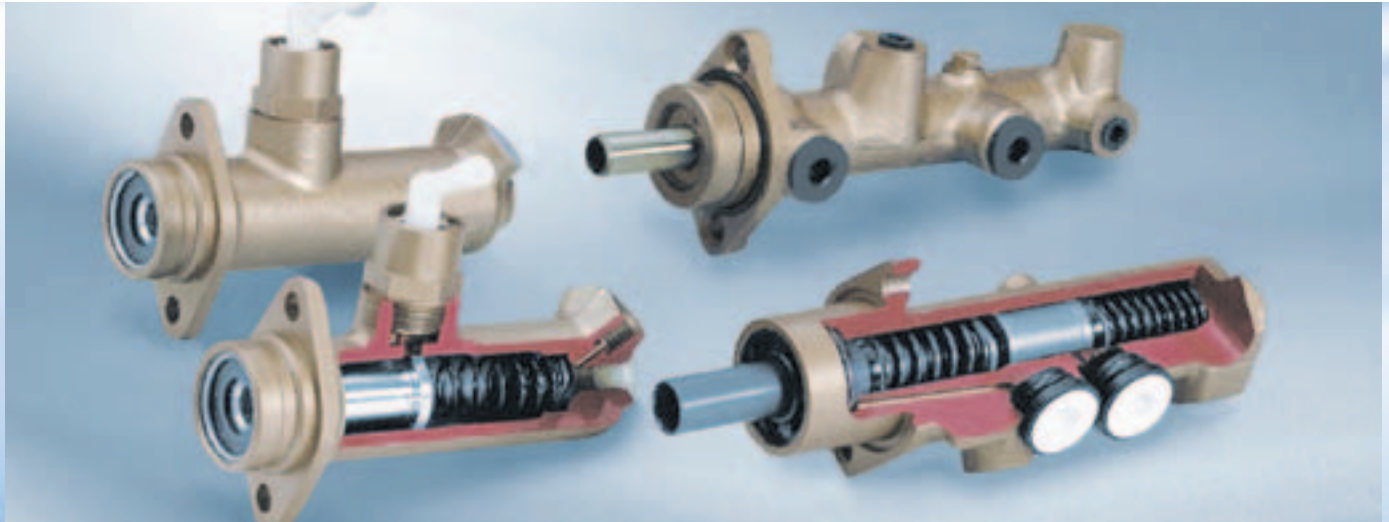

**Volle Bremskraft auf
lange Sicht**

Der Hauptzylinder wandelt den Druck auf das Bremspedal in hydraulischen Druck für zwei getrennte Bremskreise.

**Full braking force over
the long term**

The master cylinder converts the pressure on the brake pedal into hydraulic pressure for two separate brake circuits.

**Toute la force de
freinage, longtemps**

Le maître-cylindre convertit la pression exercée sur la pédale de frein en une pression hydraulique pour deux circuits de freinage séparés.

**Piena forza frenante per
molto tempo**

Il cilindro maestro del freno trasforma la pressione sul pedale del freno in pressione idraulica per due circuiti frenanti separati.

**Plena fuerza de frenado
a largo plazo**

El cilindro principal de freno convierte la presión ejercida sobre el pedal de freno en presión hidráulica para dos circuitos de freno separados.

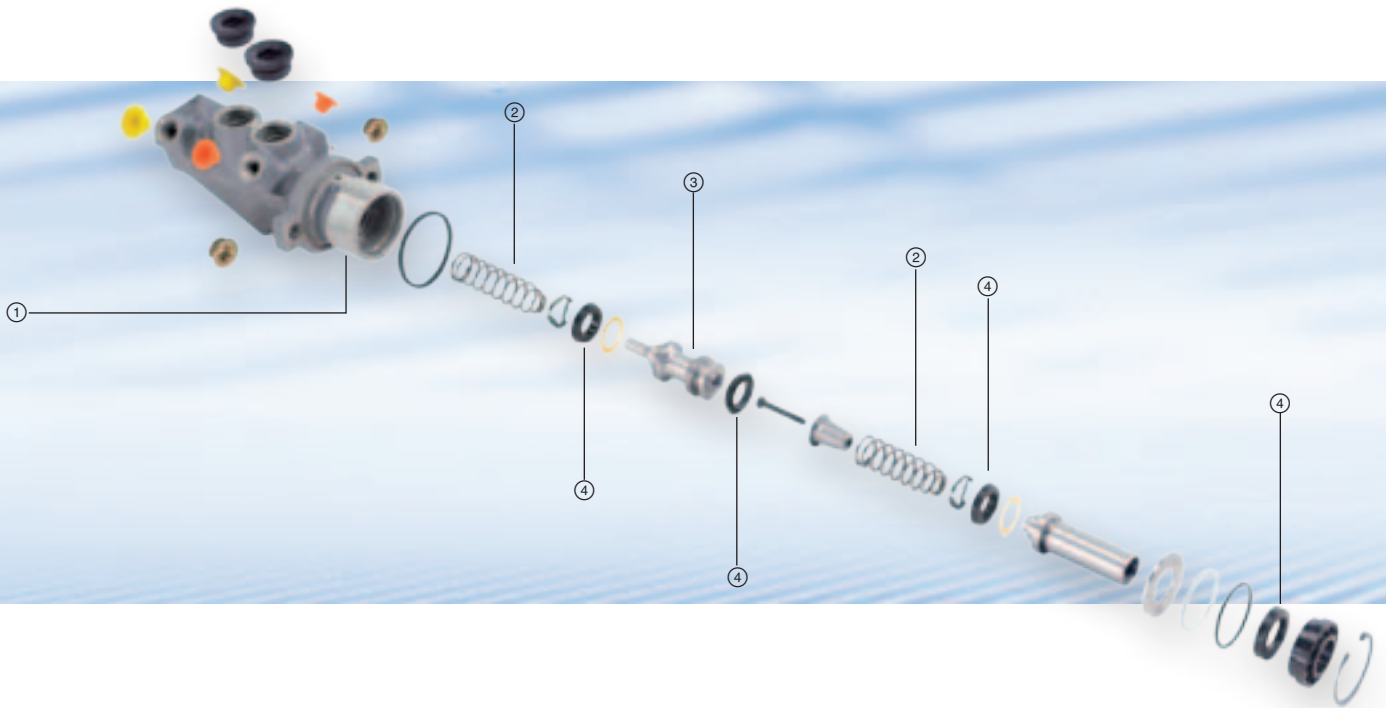
Tandem-Hauptzylinder

- ① Gehäuse
- ② Federn
- ③ Kolben
- ④ Manschetten

Tandem master cylinder

- ① Housing
- ② Springs
- ③ Piston
- ④ Sleeves

Maître-cylindre tandem

- ① Boîtier
- ② Ressorts
- ③ Piston
- ④ Manchons

Cilindro maestro a tandem

- ① Scatola
- ② Molle
- ③ Pistoncino
- ④ Manicotti

Cilindro principal tándem

- ① Carcasa
- ② Resortes
- ③ Embolo
- ④ Manguitos

de

Radbremsszylinder mit integriertem Regler (CRCI)

en

Wheel-brake cylinder with integrated regulator (CRCI)

fr

Cylindre de roue correcteur intégré (CRCI)

it

Cilindretto del freno con regolatore integrato (CRCI)

es

Cilindros de rueda con regulador integrado (CRCI)

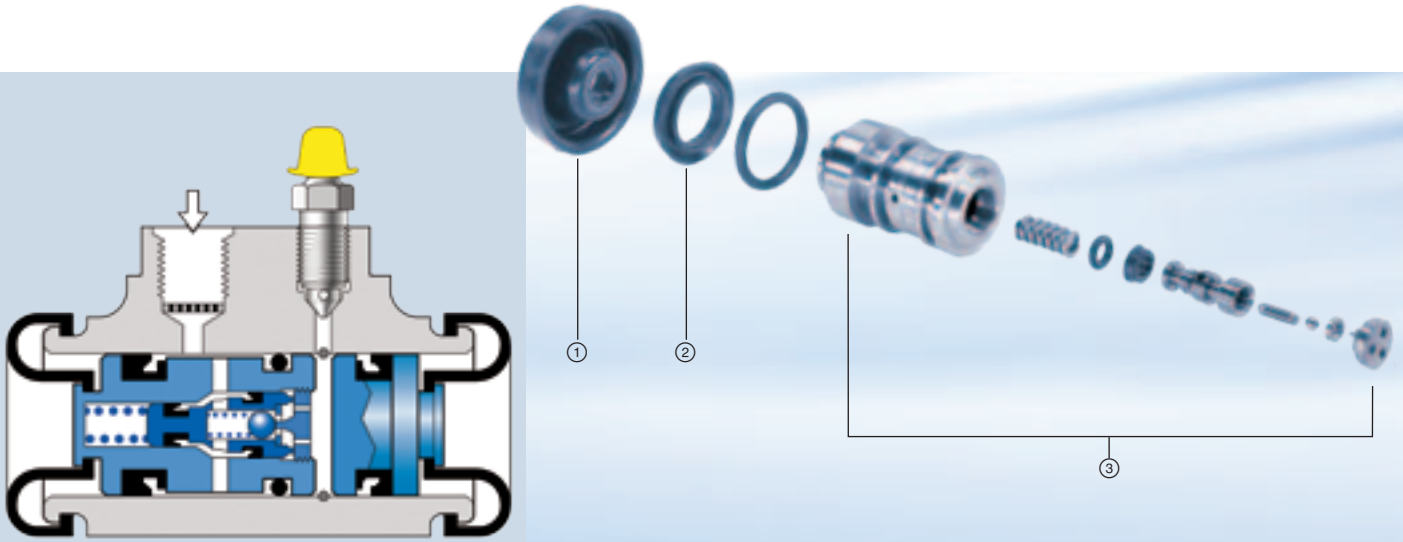

Beim CRCI-Radbremsszylinder sitzt die Entlüftungsschraube asymmetrisch zur Achse. CRCI-Radbremsszylinder ersparen einen externen Bremskraftregler, reduzieren das Fahrzeuggewicht und ermöglichen eine radselektive Drucksteuerung. Ohne Druckverlust.

CRCI type – the bleeder screw is located asymmetrically to the wheel-brake cylinder axis. With CRCI wheel-brake cylinders, the external braking-force regulator and the wear involved become a thing of the past. The vehicle's weight is reduced, and wheel-selective pressure control becomes possible. All with no loss of pressure.

La vis de purge d'air du cylindre de frein de roue CRCI est excentré par rapport à l'axe. Avec un cylindre de roue CRCI, il n'y a pas de compensateur dans le circuit de freinage – ce qui réduit le poids du véhicule. La correction de l'effort de freinage se fait indépendamment et sans perte sur chaque roue de l'axe arrière.

Nel cilindretto del freno CRCI la vite di spurgo è asimmetrica rispetto all'asse. I cilindretti del freno CRCI non necessitano un correttore di frenata esterno, evitando così una loro usura. Si riduce il peso del veicolo e viene reso possibile un controllo della pressione frenante su ogni singola ruota, senza calo di pressione.

En el cilindro de rueda CRCI el tornillo de purga se asienta asimétricamente respecto al eje. Los cilindros de rueda CRCI no necesitan un regulador de fuerza de frenado externo y evitan su desgaste. Reducen el peso del vehículo y permiten el control de la presión de frenado selectivo por rueda, sin pérdida de presión.

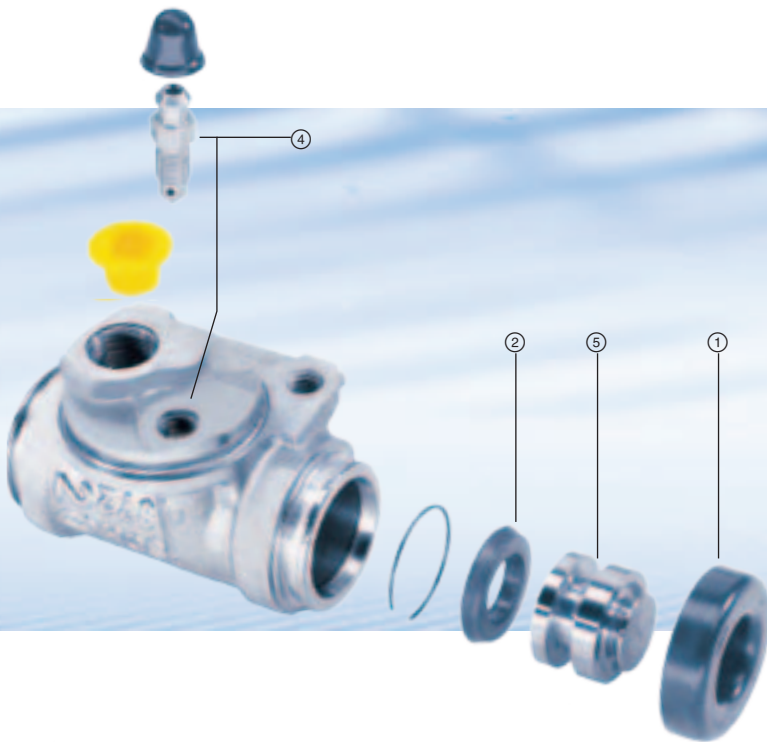

- ① Staubschutz-
manschette
- ② Kolbendichtung
- ③ Integrierter Ventil-
mechanismus zur
präzisen Steuerung
des Bremsdruckes
- ④ Entlüftungsschraube
- ⑤ Kolben

- ① Dust sleeve
- ② Piston seal
- ③ Incorporated valve-
mechanism for the
precise braking-
pressure control
- ④ Bleeder screw
- ⑤ Piston

- ① Pare-poussière
- ② Joint de piston
- ③ Mécanisme de
soupape intégré pour
un pilotage précis de
la pression de freinage
- ④ Vis de purge d'air
- ⑤ Piston

- ① Cuffia parapolvere
- ② Guarnizione del
pistoncino
- ③ Meccanismo integrato
a valvola per una
gestione precisa della
pressione frenante
- ④ Vite di spurgo d'aria
- ⑤ Pistoncino

- ① Guardapolvo
- ② Guarnición del émbolo
- ③ Mecanismo de válvu-
las integrado para un
control preciso de la
presión de frenado
- ④ Tornillo de purga de
aire
- ⑤ Pistón

de

Hauptbrems-
zylinder

en

Master
cylinders

fr

Maitres-cylindres
de freins

it

Pompa
freni

es

Cilindro
principal**0 204 022 ...**

0 204 022 753 FORD Ranger

0 204 024 ...

0 204 024 070 25,4 FORD Transit

0 204 024 071 25,4 FORD Transit

0 204 032 ...

0 204 032 301 22,21 FIAT Fiorino

0 204 032 307 FORD F

0 204 032 594 FORD F

0 204 032 601 FIAT Fiorino Furgao

0 204 032 611 FORD F

0 204 032 617 TOYOTA Hilux

0 204 032 620 TOYOTA Hilux

0 204 032 819 FORD F

0 204 032 820 FORD F

0 204 032 824 FORD Ranger

0 204 051 ...

0 204 051 514 MERCEDES-BENZ Sprinter

0 204 051 742 26,99 NISSAN Cabstar

0 204 051 743 26,99 NISSAN Cabstar

0 204 0A2 ...

0 204 0A2 169 FORD F

0 204 122 ...

0 204 122 112 20,64 SEAT Terra

0 204 122 183 31,75 IVECO EuroCargo

0 204 122 187 33,34 IVECO EuroCargo

0 204 122 237 19,05 FIAT Panda Van

0 204 122 270 23,8 FIAT Ducato 10

0 204 123 ...

0 204 123 029 23,8 VW (VOLKSWAGEN) Bus

0 204 123 056 20,6 PEUGEOT 504 Pickup

0 204 123 077 22 FORD Transit

0 204 123 083 22 FORD Transit

0 204 123 094 17,5 PEUGEOT 205 Pickup

0 204 123 113 20,6 CITROËN C 15

0 204 123 172 20,6 PEUGEOT 205 Pickup

0 204 123 176 20,6 RENAULT Clio I

0 204 123 182 23,8 CITROËN Jumpy

0 204 123 233 28,57 SANTANA 2000-Serie

0 204 123 241 28,57 EBRO (MISA) L

0 204 123 314 25,4 CITROËN Jumper

0 204 123 319 22,19 CITROËN Jumper

0 204 123 320 22,19 CITROËN Jumper

0 204 123 325 23,8 CITROËN Jumper

0 204 123 341 23,8 CITROËN Berlingo

0 204 123 350 23,8 CITROËN Berlingo

0 204 123 355 23,8 FORD Transit

0 204 123 357 19 RENAULT Clio I

0 204 123 367 23,8 MERCEDES-BENZ Vito

0 204 123 371 22,19 RENAULT Kangoo I

0 204 123 372 22,19 RENAULT Kangoo I

0 204 123 373 23,8 CITROËN Berlingo

0 204 123 409 RENAULT Trafic

0 204 123 413 IVECO CityClass

0 204 123 471 23,8 FORD P 100

0 204 123 483 23,8 VW (VOLKSWAGEN) LT

0 204 123 508 OPEL Campo Pick-Up

0 204 123 521 22,21 SEAT Inca

0 204 123 524 22,21 FIAT Strada

0 204 123 589 22,19 RENAULT Kangoo I

0 204 123 615 25,4 CITROËN Jumper

0 204 123 616 25,4 CITROËN Jumper

0 204 123 634 23,8 RENAULT Master

0 204 123 637 23,8 OPEL Combo [Tour]

0 204 123 638 23,8 OPEL Combo [Tour]

0 204 123 639 22,19 OPEL Combo [Tour]

0 204 123 640 22,19 OPEL Combo [Tour]

0 204 123 643 23,8 MERCEDES-BENZ Vito

0 204 123 644 23,8 CITROËN Berlingo

0 204 123 645 23,8 CITROËN Berlingo

0 204 123 651 23,8 RENAULT Master

0 204 123 659 22,19 OPEL Combo [Tour]

0 204 123 662 22,19 OPEL Combo [Tour]

0 204 123 685 22,19 FIAT Fiorino

0 204 123 686 22,19 FIAT Fiorino

0 204 123 711 22,19 FIAT Doblo Cargo

0 204 123 712 22,19 FIAT Doblo Cargo

0 204 123 713 23,8 FIAT Doblo Cargo

0 204 123 714 23,8 FIAT Doblo Cargo

0 204 123 716 25,4 FORD Transit

0 204 123 717 25,4 FORD Transit

0 204 123 718 25,4 FIAT Ducato 11

0 204 123 719 25,4 FIAT Ducato 11

0 204 123 720 26,9 FIAT Ducato 17

0 204 123 721 26,9 FIAT Ducato 17

0 204 123 722 25,4 FIAT Ducato 11

0 204 123 723 25,4 FIAT Ducato 11

0 204 123 724 26,9 FIAT Ducato 17

0 204 123 725 26,9 FIAT Ducato 17

0 204 123 759 22,19 RENAULT Kangoo II

0 204 123 760 22,19 RENAULT Kangoo II

0 204 123 763 23,8 RENAULT Master

0 204 123 767 22,19 FIAT Fiorino

0 204 255 ...

0 204 255 049 25,4 MERCEDES-BENZ Sprinter



0 986 480 ...



0 986 480 059 23,8 MERCEDES-BENZ 2t

0 986 480 060 25,4 MERCEDES-BENZ 4t

0 986 480 062 25,4 MERCEDES-BENZ 2t





de	en	fr	it	es
Radbremss- zylinder	Wheel-brake cylinders	Cylindres de freins de roues	Cilindretti freno	Cilindros de rueda

	∅ mm		
0 204 072 ...			
0 204 072 180	23,8	CHEVROLET	S10
0 204 072 181	23,8	CHEVROLET	S10
0 204 116 ...			
0 204 116 324	25,4	NISSAN	Trade
0 204 116 402	22,19	SEAT	Terra
0 986 475 ...			
0 986 475 023	15	MERCEDES-BENZ	2t
0 986 475 029	19,05	OPEL	Combo
0 986 475 039	20,64	SEAT	Inca
0 986 475 042	22,19	MERCEDES-BENZ	4t
0 986 475 045	22,19	VAUXHALL	Combo
0 986 475 051	25,4	RENAULT	Trafic
0 986 475 056	22,19	FIAT	Talento
0 986 475 143	19,05	CHEVROLET	Corsa Pick-Up
0 986 475 233	22,19	RENAULT	Express, Extra, Rapid
0 986 475 234	22,19	RENAULT	Express, Extra, Rapid
0 986 475 260	17,46	VW (VOLKSWAGEN)	Caddy Pickup
0 986 475 420	25,4	CITROËN	C
0 986 475 428	20,6	PEUGEOT	205 Pickup
0 986 475 433	19,05	VW (VOLKSWAGEN)	Caddy Pickup
0 986 475 475	25,4	VW (VOLKSWAGEN)	LT
0 986 475 476	25,4	VW (VOLKSWAGEN)	LT
0 986 475 512	22,19	PEUGEOT	504 Pickup
0 986 475 558	20,62	NISSAN	Vanette
0 986 475 574	20,62	TOYOTA	Liteace
0 986 475 612	27	CITROËN	C
0 986 475 614	26,99	VW (VOLKSWAGEN)	LT
0 986 475 643	20,6	RENAULT	Clio I
0 986 475 644	20,6	RENAULT	Clio I
0 986 475 657	23,8	TOYOTA	Dyna 100
0 986 475 662	25,4	MERCEDES-BENZ	MB
0 986 475 669	25,4	NISSAN	Cabstar
0 986 475 677	22,19	RENAULT	Express
0 986 475 701	22,19	FORD	Transit
0 986 475 702	22,19	FORD	Transit
0 986 475 703	23,8	FORD	P 100
0 986 475 704	23,8	FORD	P 100
0 986 475 718	20,6	MITSUBISHI	Colt L300
0 986 475 719	20,6	MITSUBISHI	Colt L300
0 986 475 727	23,8	TOYOTA	Hiace Van
0 986 475 728	22,19	SUZUKI	SJ 410
0 986 475 729	22,19	SUZUKI	SJ 410
0 986 475 742	20,6	FORD	Transit
0 986 475 758	23,8	NISSAN	Pickup
0 986 475 759	23,8	NISSAN	Vanette Cargo
0 986 475 761	22,19	NISSAN	Vanette

	∅ mm		
0 986 475 769	19	SKODA	Pick-Up
0 986 475 801	25,4	CITROËN	Jumper
0 986 475 802	27	CITROËN	Jumper
0 986 475 803	28,6	CITROËN	Jumper
0 986 475 807	25,4	ISUZU	Pick-Up
0 986 475 816	20,64	FIAT	Doblo Cargo
0 986 475 821	25,4	FORD	Transit
0 986 475 822	25,4	FORD	Transit
0 986 475 824	20,3	FORD	Transit
0 986 475 825	20,3	FORD	Transit
0 986 475 836	22,19	CITROËN	Berlingo
0 986 475 845	20,6	TOYOTA	Dyna 100
0 986 475 858	22,19	SUZUKI	SJ 410
0 986 475 859	22,19	SUZUKI	SJ 410
0 986 475 865	22,19	SKODA	Pick-Up
0 986 475 867	20,64	FIAT	Fiorino
0 986 475 872	22,19	JEEP	Cherokee
0 986 475 873	22,19	JEEP	Cherokee
0 986 475 876	22,19	TOYOTA	Dyna 100
0 986 475 877	25,4	TOYOTA	Hiace
0 986 475 894	22,19	TOYOTA	Hilux Pickup
0 986 475 901	20,64	FIAT	Doblo Cargo
0 986 475 906	26,99	CITROËN	Jumper
0 986 475 915	25,4	NISSAN	Vanette Cargo
0 986 475 916	20,64	JEEP	Cherokee
0 986 475 919	23,8	MITSUBISHI	L 200
0 986 475 920	23,8	MITSUBISHI	L 200
0 986 475 921	22,19	MITSUBISHI	L 200
0 986 475 922	22,19	MITSUBISHI	L 200
0 986 475 924	20,6	NISSAN	Pickup
0 986 475 927	20,64	FORD	Transit Connect
0 986 475 935	20,64	VW (VOLKSWAGEN)	California T4
0 986 475 936	20,64	FIAT	Doblo Cargo
0 986 475 950		CITROËN	Jumpy
0 986 475 957	19	HYUNDAI	Grace
0 986 475 958	19	HYUNDAI	Grace
0 986 475 959	22,19	HYUNDAI	H 100
0 986 475 960	22,19	HYUNDAI	H 100
0 986 475 964	19	SUZUKI	Carry
0 986 475 965	19	SUZUKI	Carry
F 026 002 ...			
F 026 002 080	22,19	CITROËN	C 15
F 026 002 088	28,5	PEUGEOT	J 9
F 026 002 133	20,6	RENAULT	Express, Extra, Rapid
F 026 002 134	20,6	RENAULT	Express, Extra, Rapid
F 026 002 139	22	RENAULT	Express, Extra, Rapid
F 026 002 140	22	RENAULT	Express, Extra, Rapid
F 026 002 163	22	RENAULT	Trafic
F 026 002 164	23,8	RENAULT	Trafic
F 026 002 171	20,6	FORD	Transit
F 026 002 172	22,19	FORD	Transit
F 026 002 173	25,4	FORD	Transit
F 026 002 176	22,19	RENAULT	Express, Extra, Rapid
F 026 002 177	22,19	RENAULT	Express, Extra, Rapid

de	en	fr	it	es
Scheibenbrems- sättel	Disk-brake calipers	Etriers de freins à disques	Pinze freno a disco	Pinzas de freno de disco







				
0 204 001 935	0 204 001 936	54	RENAULT	Kangoo I
0 204 004 175	0 204 004 176	38	RENAULT	Kangoo I
0 204 004 238	0 204 004 237	45	RENAULT	Master
0 204 004 320	0 204 004 321	42	NISSAN	Interstar
			OPEL	Movano
			RENAULT	Master
			VAUXHALL	Movano
0 204 004 515	0 204 004 516	38	MERCEDES-BENZ	Vito
0 204 004 519	0 204 004 520	51	MERCEDES-BENZ	Sprinter
0 204 004 523	0 204 004 520	48	MERCEDES-BENZ	Sprinter
0 204 004 564	0 204 004 565	54	FIAT	Doblo Cargo, Fiorino, Fiorino Qubo
0 204 004 566	0 204 004 567	54	FIAT	Doblo Cargo
0 204 004 615	0 204 004 616	48	FORD	Transit
0 204 004 617	0 204 004 618	48	FORD	Transit, Transit Euroline, Nugget, Tourneo
0 204 102 052	0 204 102 054	45	RENAULT	Trafic
			VAUXHALL	Arena
0 204 102 075	0 204 102 077	30	RENAULT	Clio I
0 204 102 083	0 204 102 085	45	RENAULT	Express, Extra, Rapid
0 204 102 087	0 204 102 089	54	RENAULT	Trafic
0 204 102 226	0 204 102 227	48	PEUGEOT	205 Pickup
0 204 102 249	0 204 102 250	48	RENAULT	Clio I, Express, Extra, Rapid
0 204 102 289	0 204 102 290	48	CITROEN	C 15
			PEUGEOT	205 Pickup
0 204 102 295	0 204 102 296	52	NISSAN	Trade
0 204 102 322	0 204 102 323	52	MERCEDES-BENZ	MB, O 100
0 204 102 371	0 204 102 372	48	MERCEDES-BENZ	MB
0 204 102 447	0 204 102 448	48	FIAT	Panda Van, Uno Van
0 204 102 521	0 204 102 523	57	CITROEN	Jumpy
			FIAT	Scudo
			PEUGEOT	Expert
0 204 102 524	0 204 102 547	48	FIAT	Uno Van
	0 204 102 525	48	FIAT	Uno Van
0 204 102 730	0 204 102 731	45	OPEL	Movano
			RENAULT	Master
			VAUXHALL	Movano
0 204 102 912	0 204 102 913	44	MERCEDES-BENZ	Sprinter
0 204 102 914	0 204 102 915	60	MERCEDES-BENZ	Vito
0 204 102 916	0 204 102 917	33	MERCEDES-BENZ	Vito
0 204 102 918	0 204 102 919	52	MERCEDES-BENZ	Sprinter
			VW (VOLKSWAGEN)	LT
0 204 102 926	0 204 102 925	42	FORD	Transit, Transit Euroline, Nugget, Tourneo
0 204 102 935	0 204 102 934	42	FORD	Transit, Transit Euroline, Nugget, Tourneo
0 204 102 969	0 204 102 970	45	RENAULT	Master
0 204 102 971	0 204 102 972	54	CITROEN	Berlingo
			PEUGEOT	Partner, Ranch
0 204 102 995	0 204 102 996	54	RENAULT	Kangoo I
0 204 204 673	0 204 204 674	48	MERCEDES-BENZ	Vito
0 204 204 992	0 204 204 993	48	FORD	Transit, Transit Euroline, Nugget, Tourneo
0 204 902 000	0 204 902 001	48	FIAT	Ducato 11, Ducato 15, Ducato 17, Ducato Maxi 17, Ducato Maxi 20
0 204 902 026	0 204 902 027	48	FORD	Transit, Transit Euroline, Nugget, Tourneo
0 204 902 119	0 204 902 120		FIAT	Doblo Cargo
0 986 471 462	0 986 472 462	48	BEDFORD	Astra, Astramax
0 986 471 668	0 986 472 668	60	VW (VOLKSWAGEN)	Bus, Transporter T3, Microbus



0 986 471 669	0 986 472 669	54	SEAT	Inca
			VW (VOLKSWAGEN)	Caddy
0 986 471 672	0 986 472 672	48	CITROEN	C 15
			PEUGEOT	205 Pickup
0 986 471 895	0 986 471 896	48	CHEVROLET	Corsa Pick-Up
0 986 471 899	0 986 471 900	48	CHEVROLET	Corsa Pick-Up
			OPEL	Combo
			VAUXHALL	Combo
0 986 471 979	0 986 471 980	44	MERCEDES-BENZ	2t, 3t, 4t, 5t
0 986 472 832	0 986 472 833	38	VW (VOLKSWAGEN)	California T4, Caravelle T4, Eurovan, Multivan T4, Transporter T4
0 986 472 834	0 986 472 835	38	VW (VOLKSWAGEN)	California T4, Caravelle T4, Eurovan, Multivan T4, Transporter T4

de	en	fr	it	es
Scheibenbrems- sättel	Disk-brake calipers	Etriers de freins à disques	Pinze freno a disco	Pinzas de freno de disco



				
0 204 001 935	0 204 001 936	54	RENAULT	Kangoo I
0 204 004 175	0 204 004 176	38	RENAULT	Kangoo I
0 204 004 238	0 204 004 237	45	RENAULT	Master
0 204 004 320	0 204 004 321	42	NISSAN	Interstar
			OPEL	Movano
			RENAULT	Master
			VAUXHALL	Movano
0 204 004 515	0 204 004 516	38	MERCEDES-BENZ	Vito
0 204 004 519	0 204 004 520	51	MERCEDES-BENZ	Sprinter
0 204 004 523	0 204 004 520	48	MERCEDES-BENZ	Sprinter
0 204 004 564	0 204 004 565	54	FIAT	Doblo Cargo, Fiorino, Fiorino Qubo
0 204 004 566	0 204 004 567	54	FIAT	Doblo Cargo
0 204 004 615	0 204 004 616	48	FORD	Transit
0 204 004 617	0 204 004 618	48	FORD	Transit, Transit Euroline, Nugget, Tourneo
0 204 102 052	0 204 102 054	45	RENAULT	Trafic
			VAUXHALL	Arena
0 204 102 075	0 204 102 077	30	RENAULT	Clio I
0 204 102 083	0 204 102 085	45	RENAULT	Express, Extra, Rapid
0 204 102 087	0 204 102 089	54	RENAULT	Trafic
0 204 102 226	0 204 102 227	48	PEUGEOT	205 Pickup
0 204 102 249	0 204 102 250	48	RENAULT	Clio I, Express, Extra, Rapid
0 204 102 289	0 204 102 290	48	CITROËN	C 15
			PEUGEOT	205 Pickup
0 204 102 295	0 204 102 296	52	NISSAN	Trade
0 204 102 322	0 204 102 323	52	MERCEDES-BENZ	MB, O 100
0 204 102 371	0 204 102 372	48	MERCEDES-BENZ	MB
0 204 102 447	0 204 102 448	48	FIAT	Panda Van, Uno Van
0 204 102 521	0 204 102 523	57	CITROËN	Jumpy
			FIAT	Scudo
			PEUGEOT	Expert
0 204 102 524	0 204 102 547	48	FIAT	Uno Van
	0 204 102 525	48	FIAT	Uno Van
0 204 102 730	0 204 102 731	45	OPEL	Movano
			RENAULT	Master
			VAUXHALL	Movano
0 204 102 912	0 204 102 913	44	MERCEDES-BENZ	Sprinter
0 204 102 914	0 204 102 915	60	MERCEDES-BENZ	Vito
0 204 102 916	0 204 102 917	33	MERCEDES-BENZ	Vito
0 204 102 918	0 204 102 919	52	MERCEDES-BENZ	Sprinter
			VW (VOLKSWAGEN)	LT
0 204 102 926	0 204 102 925	42	FORD	Transit, Transit Euroline, Nugget, Tourneo
0 204 102 935	0 204 102 934	42	FORD	Transit, Transit Euroline, Nugget, Tourneo
0 204 102 969	0 204 102 970	45	RENAULT	Master
0 204 102 971	0 204 102 972	54	CITROËN	Berlingo
			PEUGEOT	Partner, Ranch
0 204 102 995	0 204 102 996	54	RENAULT	Kangoo I
0 204 204 673	0 204 204 674	48	MERCEDES-BENZ	Vito
0 204 204 992	0 204 204 993	48	FORD	Transit, Transit Euroline, Nugget, Tourneo
0 204 902 000	0 204 902 001	48	FIAT	Ducato 11, Ducato 15, Ducato 17, Ducato Maxi 17, Ducato Maxi 20
0 204 902 026	0 204 902 027	48	FORD	Transit, Transit Euroline, Nugget, Tourneo
0 204 902 119	0 204 902 120		FIAT	Doblo Cargo
0 986 471 462	0 986 472 462	48	BEDFORD	Astra, Astramax
0 986 471 668	0 986 472 668	60	VW (VOLKSWAGEN)	Bus, Transporter T3, Microbus









0 986 471 669	0 986 472 669	54	SEAT	Inca
			VW (VOLKSWAGEN)	Caddy
0 986 471 672	0 986 472 672	48	CITROËN	C 15
			PEUGEOT	205 Pickup
0 986 471 895	0 986 471 896	48	CHEVROLET	Corsa Pick-Up
0 986 471 899	0 986 471 900	48	CHEVROLET	Corsa Pick-Up
			OPEL	Combo
			VAUXHALL	Combo
0 986 471 979	0 986 471 980	44	MERCEDES-BENZ	2t, 3t, 4t, 5t
0 986 472 832	0 986 472 833	38	VW (VOLKSWAGEN)	California T4, Caravelle T4, Eurovan, Multivan T4, Transporter T4
0 986 472 834	0 986 472 835	38	VW (VOLKSWAGEN)	California T4, Caravelle T4, Eurovan, Multivan T4, Transporter T4

**1 987 476 ...**

1 987 476 006	200	FIAT	Ducato 11, Ducato 15, Uno Van
1 987 476 012	175	SKODA VW (VOLKSWAGEN)	Pick-Up Caddy Pickup
1 987 476 030	195	CHEVROLET	Corsa Pick-Up
1 987 476 032	315	OPEL RENAULT VAUXHALL	Arena Trafic Arena
1 987 476 059	368	FORD	Transit Connect
1 987 476 064	453	RENAULT	Kangoo I
1 987 476 065	335	RENAULT	Kangoo I
1 987 476 067	335	RENAULT	Kangoo I
1 987 476 077	420	MERCEDES-BENZ	2t, 3t, 4t, 8t
1 987 476 125	465	FIAT	Doblo Cargo
1 987 476 138	380	VW (VOLKSWAGEN)	Bus, Transporter T3
1 987 476 139	440	VW (VOLKSWAGEN)	Bus, LT, Transporter T3
1 987 476 144	412	OPEL VAUXHALL	Combo Combo
1 987 476 147	515	OPEL VAUXHALL	Campo Pick-Up Brava Pick-Up
1 987 476 150	370	CITROËN	C 15
1 987 476 169	425	SEAT VW (VOLKSWAGEN)	Inca Caddy
1 987 476 178	280	CITROËN PEUGEOT	Berlingo Partner, Ranch
1 987 476 193		MITSUBISHI	L 200, L 300, L 300 Van, L300 Wagon
1 987 476 194	285	MITSUBISHI	L 200
1 987 476 200	230	OPEL	Combo [Tour]
1 987 476 202		OPEL VAUXHALL	Combo [Tour] Combo [Tour]
1 987 476 216	180	VW (VOLKSWAGEN)	Bus, Transporter T3
1 987 476 217	310	VW (VOLKSWAGEN)	Caddy Pickup
1 987 476 220	160	VW (VOLKSWAGEN)	California T4, Caravelle T4, Eurovan, Multivan T4, Transporter T4
1 987 476 230	160	VW (VOLKSWAGEN)	California T4, Caravelle T4, Eurovan, Multivan T4, Transporter T4
1 987 476 239	280	FIAT	Panda Van
1 987 476 244	265	CITROËN FIAT PEUGEOT	C Ducato 10, Ducato 14 J 5
1 987 476 282	577	VW (VOLKSWAGEN)	Caddy



1 987 476 294	490	MERCEDES-BENZ	Sprinter
1 987 476 295		MERCEDES-BENZ VW (VOLKSWAGEN)	Sprinter LT
1 987 476 297	460	MERCEDES-BENZ	Sprinter
1 987 476 300	388	MERCEDES-BENZ	Sprinter
1 987 476 309	250	VW (VOLKSWAGEN)	California T5, Caravelle T5, Multivan T5, Transporter T5
1 987 476 310	190	VW (VOLKSWAGEN)	California T5, Caravelle T5, Multivan T5, Transporter T5
1 987 476 313	243	VW (VOLKSWAGEN)	California T5, Caravelle T5, Multivan T5, Transporter T5
1 987 476 317	320	SKODA VW (VOLKSWAGEN)	Pick-Up Caddy Pickup
1 987 476 320	243	VW (VOLKSWAGEN)	California T5, Caravelle T5, Multivan T5, Transporter T5
1 987 476 329	485	CITROËN FIAT PEUGEOT	Jumper Ducato 10, Ducato 14, Ducato 18 Boxer
1 987 476 345	220	MITSUBISHI	L 300 Van, L 300 Wagon
1 987 476 380	297	VW (VOLKSWAGEN)	LT
1 987 476 391	475	MERCEDES-BENZ	5t, 6t, 7t, 8t
1 987 476 392	470	MERCEDES-BENZ	2t, 3t, 4t, 7t, 8t
1 987 476 398	525	VW (VOLKSWAGEN)	Caddy
1 987 476 411	330	VW (VOLKSWAGEN)	California T4, Caravelle T4, Eurovan, Multivan T4, Transporter T4
1 987 476 413	410	FIAT	Uno Van
1 987 476 415	435	SEAT VW (VOLKSWAGEN)	Inca Caddy
1 987 476 416	185	FIAT	Panda Van
1 987 476 421	240	RENAULT	Clio I
1 987 476 432	315	OPEL RENAULT VAUXHALL	Arena Trafic Arena
1 987 476 445	435	FIAT	Uno Van
1 987 476 451	425	FIAT	Fiorino, Fiorino Qubo

			
1 987 476 462	435		CITROËN C
			FIAT Ducato 10, Ducato 14, Ducato 18, Talento
			PEUGEOT J 5
1 987 476 463	435		CITROËN C
			FIAT Ducato 10, Ducato 14, Ducato 18, Talento
			PEUGEOT J 5
1 987 476 493	270	RENAULT	Express, Extra, Rapid
1 987 476 495	280	TOYOTA	Liteace
1 987 476 502	210	MITSUBISHI	L 200, L 300, L 300 Van, L300 Wagon, L 300 Truck, L 400
1 987 476 510	430	FORD	Transit, Transit Euroline, Nugget, Tourneo
1 987 476 511	430	FORD	Transit, Transit Euroline, Nugget, Tourneo
1 987 476 512	275	FORD	Transit
1 987 476 513	275	FORD	Transit
1 987 476 514	275	FORD	Transit
1 987 476 515	275	FORD	Transit
1 987 476 517	332	RENAULT	Express, Extra, Rapid
			1 987 476 519
1 987 476 521	435	PEUGEOT	205 Pickup
			1 987 476 522
1 987 476 523	276	PEUGEOT	205 Pickup
1 987 476 548	385	CITROËN	C
			FIAT Ducato 10
1 987 476 549	466	OPEL	Campo Pick-Up
			VAUXHALL Brava Pick-Up
1 987 476 551	485	TOYOTA	Dyna 100
1 987 476 557	288	RENAULT	Clio I
1 987 476 614	447	FORD	Transit, Transit Euroline, Nugget, Tourneo
			1 987 476 615
1 987 476 629	160		CITROËN Jumper
			FIAT Ducato 11, Ducato 15
			PEUGEOT Boxer
1 987 476 645	365	SKODA	Pick-Up
1 987 476 647	235	SKODA	Pick-Up
1 987 476 651	440	CITROËN	Berlingo, Partner, Ranch
1 987 476 686	205	CITROËN	C 15
1 987 476 688	290		FIAT Ducato 10, Ducato 12, Ducato 14, Ducato 18
			PEUGEOT J 5

			
1 987 476 689	335		CITROËN Jumper
			FIAT Ducato 10, Ducato 14, Ducato 18
			PEUGEOT Boxer, J5
1 987 476 691	340	CHEVROLET	Corsa Pick-Up
			OPEL Combo
1 987 476 698	375	VAUXHALL	Combo
			VW (VOLKSWAGEN) California T4, Caravelle T4, Eurovan, Multivan T4, Transporter T4
1 987 476 699	300	RENAULT	Express, Extra, Rapid
1 987 476 700	380	NISSAN	Primastar
			OPEL Vivaro
			RENAULT Trafic
1 987 476 701	455	VAUXHALL	Arena, Vivaro
			RENAULT Trafic
1 987 476 708	250	RENAULT	Clio I
1 987 476 737	270	MITSUBISHI	Colt L300, L 300 van
1 987 476 772	280	SUZUKI	SJ 410, SJ 410 Pickup
			1 987 476 785
1 987 476 879	504	FIAT	Doblo Cargo, Strada
			PEUGEOT Partner
1 987 476 881	384	FIAT	Cityvan, Fiorino
1 987 476 904	245	VAUXHALL	Combo [Tour]
1 987 476 905	435	OPEL	Movano
			RENAULT Master
			VAUXHALL Movano
1 987 476 906	565	OPEL	Movano
			RENAULT Master
			VAUXHALL Movano
1 987 476 907	610	OPEL	Movano
			VAUXHALL Movano
1 987 476 911	435	OPEL	Campo Pick-Up
			VAUXHALL Brava Pick-Up
1 987 476 914	222	NISSAN	Primastar
			OPEL Vivaro
			RENAULT Trafic
			VAUXHALL Vivaro
1 987 476 931	264	SUBARU	Libero
1 987 476 940	440	TOYOTA	Hilux Pickup
1 987 476 943	345	TOYOTA	Hilux Pickup
1 987 476 947	250	CITROËN	Jumpy
			FIAT Scudo
			PEUGEOT Expert
1 987 476 951	470	CITROËN	Jumpy
			FIAT Scudo
			PEUGEOT Expert
1 987 476 954	255	FIAT	Cityvan, Fiorino, Uno Furgoneta
1 987 476 955	335	RENAULT	Kangoo I
1 987 476 956	195	RENAULT	Kangoo I
1 987 476 958	459	NISSAN	Vanette

de

Bremsschläuche
(Fortsetzung)

en

Brake hoses
(continued)

fr

Flexibles de frein
(suite)

it

Tubi flessibili freno
(seguito)

es

Latiguillos de freno
(continuación)

1 987 481 ...			
1 987 481 001	328	MERCEDES-BENZ	Vito
1 987 481 002	360	CITROËN	Jumper
		FIAT	Ducato 11, Ducato 15, Ducato 18
		PEUGEOT	Boxer
1 987 481 003	370	VW (VOLKSWAGEN)	LT
1 987 481 004	470	CITROËN	Jumper
		FIAT	Ducato 11, Ducato 15, Ducato 18
		PEUGEOT	Boxer
1 987 481 005	495	MERCEDES-BENZ	Vito
1 987 481 006	498	MERCEDES-BENZ	Vito
1 987 481 007	518	MERCEDES-BENZ	Vito
1 987 481 008	235	VW (VOLKSWAGEN)	LT
1 987 481 009	180	HYUNDAI	Grace, H 100
1 987 481 010	182	MINI	L 200
1 987 481 011	190	MINI	L 200, L 300 Van, L 300 Wagon
1 987 481 013	245	MINI	L 200
1 987 481 017	360	CITROËN	Jumper
		FIAT	Ducato 10, Ducato 14, Ducato 18
		PEUGEOT	Boxer
1 987 481 018	385	CITROËN	Jumper
		FIAT	Ducato 10, Ducato 11, Ducato 14, Ducato 15, Ducato 18
		PEUGEOT	Boxer
1 987 481 019	385	CITROËN	Jumper
		FIAT	Ducato 10, Ducato 11, Ducato 14, Ducato 15, Ducato 18
		PEUGEOT	Boxer
1 987 481 020	410	VW (VOLKSWAGEN)	LT
1 987 481 025	535	NISSAN	Vanette Cargo
1 987 481 030	280	MERCEDES-BENZ	MB
1 987 481 031	355	MINI	L 300 Truck, L 300 Van, L 300 Wagon
1 987 481 034	504	RENAULT	Master
1 987 481 036	380	TOYOTA	Hiace Van, Hiace Wagon
1 987 481 037	380	TOYOTA	Hiace Van, Hiace Wagon

1 987 481 039	295	HYUNDAI	Grace, H 100
1 987 481 040	374	TOYOTA	Hiace Van, Hiace Wagon
1 987 481 042		TOYOTA	Hiace Van, Hiace Wagon
1 987 481 045	475	FORD	Transit, Transit Euroline, Nugget, Tourneo
1 987 481 046	410	FORD	Transit, Transit Euroline, Nugget, Tourneo
1 987 481 047	410	FORD	Transit, Transit Euroline, Nugget, Tourneo
1 987 481 051	450	CITROËN	Berlingo
		PEUGEOT	Partner
1 987 481 052	237	PEUGEOT	Partner
1 987 481 057	492	OPEL	Movano
		VAUXHALL	Movano
1 987 481 061	360	CITROËN	Jumper
		FIAT	Ducato 10, Ducato 14, Ducato 18
		PEUGEOT	Boxer
1 987 481 063	490	CITROËN	Jumper
		FIAT	Ducato 10, Ducato 14, Ducato 18
		PEUGEOT	Boxer
1 987 481 067	500	FIAT	Ducato 11, Ducato 15, Ducato 18
1 987 481 070	478	FORD	Transit, Transit Euroline, Nugget, Tourneo
1 987 481 072	375	FORD	Transit, Transit Euroline, Nugget, Tourneo
1 987 481 073	425	FORD	Transit
1 987 481 074	480	OPEL	Movano
		VAUXHALL	Movano
1 987 481 083	460	JEEP	Cherokee
1 987 481 090	220	NISSAN	Primastar
1 987 481 094	370	MERCEDES-BENZ	MB
1 987 481 095	221	MINI	L 200
1 987 481 108	530	NISSAN	Vanette Cargo
1 987 481 118	394	FIAT	Fiorino
1 987 481 146	300	NISSAN	Vanette Cargo
1 987 481 150	507	NISSAN	Interstar
		OPEL	Movano
		RENAULT	Master
		VAUXHALL	Movano

de

Bremsseile

en

Brake cables

fr

Câbles de frein
de stationnement

it

Cavi del freno
di stazionamento



es



Cables de freno
de mano

1 987 477 ...			
1 987 477 040	1475	VW (VOLKSWAGEN)	Bus, Transporter T3
1 987 477 091	520	FIAT	Uno Van
1 987 477 101	2973	FORD	Transit
1 987 477 113	3025	CITROËN	Jumper
		FIAT	Ducato 10, Ducato 14, Ducato 18
		PEUGEOT	Boxer
1 987 477 114	1059	CITROËN	Jumper
		FIAT	Ducato 10, Ducato 14, Ducato 18, Ducato Cargo
		PEUGEOT	Boxer
1 987 477 115	3040	CITROËN	Jumper
		FIAT	Ducato 10, Ducato 14, Ducato 18
		PEUGEOT	Boxer
1 987 477 116	1603	NISSAN	Primastar
		OPEL	Vivaro
		RENAULT	Trafic
		VAUXHALL	Vivaro
1 987 477 117	1464	MERCEDES-BENZ	MB
1 987 477 118	1862	MERCEDES-BENZ	2t, 3t, Sprinter
1 987 477 119	1862	MERCEDES-BENZ	2t, 3t, Sprinter
1 987 477 121	1760	MERCEDES-BENZ	4t
1 987 477 122	1760	MERCEDES-BENZ	4t
1 987 477 125	1023	MERCEDES-BENZ	6t, 7t, 8t
1 987 477 126	1111	MERCEDES-BENZ	6t, 7t, 8t
1 987 477 137	1503	NISSAN	Primastar
		OPEL	Vivaro
		RENAULT	Trafic
		VAUXHALL	Vivaro
1 987 477 144	1396	PEUGEOT	205 Pickup
1 987 477 145	1411	PEUGEOT	205 Pickup
1 987 477 152	1453	RENAULT	Clio I
1 987 477 156	1350	RENAULT	Express, Extra, Rapid
1 987 477 171	854	VW (VOLKSWAGEN)	California T4, Caravelle T4, Multivan T4, Transporter T4
1 987 477 174	1547	FORD	Transit, Transit Euroline, Nugget, Tourneo
1 987 477 175	1587	FORD	Transit
1 987 477 177	1332	FORD	Transit
1 987 477 178	1528	FORD	Transit
1 987 477 180	1608	FORD	Transit
1 987 477 185	1386	FORD	Transit
1 987 477 186	1052	FORD	Transit, Transit Euroline, Nugget, Tourneo



1 987 477 190	910	FORD	Transit, Transit Euroline, Nugget, Tourneo
1 987 477 197	2799	MERCEDES-BENZ	Vito
1 987 477 198	2432	MERCEDES-BENZ	Vito
1 987 477 199	1170	MERCEDES-BENZ	Vito
1 987 477 203	1713	VW (VOLKSWAGEN)	Caddy
1 987 477 208	830	MERCEDES-BENZ	2t, 3t
1 987 477 209	1130	MERCEDES-BENZ	2t, 3t
1 987 477 210	1480	MERCEDES-BENZ	2t, 3t
1 987 477 211	1806	MERCEDES-BENZ	2t, 3t
1 987 477 260	1297	VW (VOLKSWAGEN)	California T5, Caravelle T5, Multivan T5, Transporter T5
1 987 477 261	1737	NISSAN	Interstar
		OPEL	Movano
		RENAULT	Master
		VAUXHALL	Movano
1 987 477 262	2806	CITROËN	Jumper
		FIAT	Ducato 10, Ducato 14, Ducato 18
		PEUGEOT	Boxer
1 987 477 263	2827	FIAT	Ducato 10, Ducato 14, Ducato 15, Ducato 18
		PEUGEOT	Boxer
1 987 477 289	2015	FIAT	Uno Van
1 987 477 296	2828	FIAT	Cityvan, Fiorino, Fiorino Pick-up
		INNOCENTI (NUOVA INNOCENTI)	Elba
1 987 477 309	1378	CHEVROLET	Corsa Pick-Up
1 987 477 310	1086	CHEVROLET	Corsa Pick-Up
1 987 477 322	2033	VW (VOLKSWAGEN)	Caddy Pickup
1 987 477 326	1413	MERCEDES-BENZ	MB
1 987 477 327	1640	MERCEDES-BENZ	MB
1 987 477 331	1300	FIAT	Panda Van
1 987 477 369	2823	FORD	Transit, Transit Euroline, Nugget, Tourneo
1 987 477 370	2730	FORD	Transit, Transit Euroline, Nugget, Tourneo
1 987 477 377	2016	FIAT	Uno Van
1 987 477 417	1608	CITROËN	C
		FIAT	Ducato 10, Ducato 12, Ducato 14
		PEUGEOT	J 5
1 987 477 419	2338	CITROËN	C
		PEUGEOT	J 5

			
1 987 477 420	1642	FIAT	Ducato 10, Ducato 12, Ducato 14
		PEUGEOT	J 5
1 987 477 421	2377	FIAT	Ducato 18
		PEUGEOT	J 5
1 987 477 461	1469	RENAULT	Express, Extra, Rapid
1 987 477 462	1465	RENAULT	Express, Extra, Rapid
1 987 477 486	1780	CITROËN	C 15
1 987 477 515	2566	CITROËN	C
		FIAT	Ducato 10, Ducato 13, Ducato 14, Ducato 18
1 987 477 523	1757	SKODA	Pick-Up
1 987 477 565	500	CITROËN	Jumpy
		FIAT	Scudo
		PEUGEOT	Expert
1 987 477 568	1063	CITROËN	Jumpy
		PEUGEOT	Expert
1 987 477 569	2286	CITROËN	Jumpy
		FIAT	Scudo
		PEUGEOT	Expert
1 987 477 576	1745	CITROËN	Berlingo
		PEUGEOT	Partner, Ranch
1 987 477 577	1818	CITROËN	Berlingo
		PEUGEOT	Partner, Ranch
1 987 477 595	1850	CITROËN	Berlingo
		PEUGEOT	Partner, Ranch
1 987 477 626	1671	SEAT	Inca
		VW (VOLKSWAGEN)	Caddy
1 987 477 632	1413	NISSAN	Kubistar
			Kangoo I
1 987 477 633	1421	NISSAN	Kubistar
		RENAULT	Kangoo I
1 987 477 634	1432	RENAULT	Kangoo I
1 987 477 635	1442	RENAULT	Kangoo I
1 987 477 662	747	OPEL	Arena
		RENAULT	Trafic
		VAUXHALL	Arena
1 987 477 663	1330	OPEL	Arena
		RENAULT	Trafic
		VAUXHALL	Arena
1 987 477 664	1295	OPEL	Arena
		RENAULT	Trafic
		VAUXHALL	Arena
1 987 477 665	1424	OPEL	Arena
		RENAULT	Trafic
		VAUXHALL	Arena
1 987 477 666	1390	OPEL	Arena
		RENAULT	Trafic
		VAUXHALL	Arena
1 987 477 680	1392	SKODA	Pick-Up
1 987 477 690	1762	VW (VOLKSWAGEN)	Caddy Pickup
1 987 477 702	1688	MERCEDES-BENZ	Sprinter

			
1 987 477 703	1688	MERCEDES-BENZ	Sprinter
1 987 477 706	938	VW (VOLKSWAGEN)	California T4, Caravelle T4, Eurovan, Multivan T4, Transporter T4
1 987 477 707	948	VW (VOLKSWAGEN)	California T4, Caravelle T4, Eurovan, Multivan T4, Transporter T4
1 987 477 723	1810	FIAT	Doblo Cargo
1 987 477 769	1659	OPEL	Combo
		VAUXHALL	Combo
1 987 477 773	2368	CITROËN	Jumpy
		PEUGEOT	Expert
1 987 477 774	900	CITROËN	Jumpy
		FIAT	Scudo
		PEUGEOT	Expert
1 987 477 792	3170	SEAT	Terra
1 987 477 816	1234	NISSAN	Vanette Cargo
1 987 477 829	1710	FIAT	Strada, Strada Adventure
1 987 477 830	1710	FIAT	Strada, Strada Adventure
1 987 477 852	1522	MERCEDES-BENZ	Sprinter
		VW (VOLKSWAGEN)	LT
1 987 477 853	1443	MERCEDES-BENZ	Sprinter
		VW (VOLKSWAGEN)	LT
1 987 477 854	1998	MERCEDES-BENZ	Sprinter
		VW (VOLKSWAGEN)	LT
1 987 477 855	2468	MERCEDES-BENZ	Sprinter
		VW (VOLKSWAGEN)	LT
1 987 477 856	1423	MERCEDES-BENZ	Sprinter
1 987 477 857	1553	MERCEDES-BENZ	Sprinter
1 987 477 858	1532	MERCEDES-BENZ	Sprinter
		VW (VOLKSWAGEN)	LT
1 987 477 859	1532	MERCEDES-BENZ	Sprinter
		VW (VOLKSWAGEN)	LT
1 987 477 860	1580	MERCEDES-BENZ	Sprinter
1 987 477 861	1575	MERCEDES-BENZ	Sprinter
1 987 477 869	1238	OPEL	Combo [Tour]
		VAUXHALL	Combo [Tour]
1 987 477 880	2448	MERCEDES-BENZ	Sprinter
		VW (VOLKSWAGEN)	LT
1 987 477 929	326	FORD	Transit Connect

de	en	fr	it	es
Bremssseile (Fortsetzung)	Brake cables (continued)	Câbles de frein de stationnement (suite)	Cavi del freno di stazionamento (seguito)	Cables de freno de mano (continuación)



	mm		
1 987 477 989	3105	FIAT	Fiorino, Fiorino Furgao, Fiorino Pick-up
1 987 482 ...			
1 987 482 002	1078	FIAT	Ducato 10, Ducato 14, Ducato 18, Ducato Cargo
		PEUGEOT	Boxer
1 987 482 003	2715	FIAT	Ducato 10, Ducato 11, Ducato 14, Ducato 15, Ducato 18, Ducato Cargo
		PEUGEOT	Boxer
1 987 482 004	1170	FIAT	Ducato 10, Ducato 14, Ducato 18
		PEUGEOT	Boxer
1 987 482 005	4100	CITROËN	Jumper
		PEUGEOT	Boxer
1 987 482 006	2827	CITROËN	Jumper
		FIAT	Ducato 10, Ducato 14, Ducato 18
		PEUGEOT	Boxer
1 987 482 007	1614	CITROËN	Jumpy
		FIAT	Scudo
		PEUGEOT	Expert
1 987 482 008	1737	CITROËN	Jumpy
		FIAT	Scudo
		PEUGEOT	Expert
1 987 482 012	1175	NISSAN	Interstar
		OPEL	Movano
		VAUXHALL	Movano
1 987 482 013	1420	NISSAN	Interstar
		OPEL	Movano
		RENAULT	Master
		VAUXHALL	Movano
1 987 482 014	1270	VW (VOLKSWAGEN)	California T5, Caravelle T5, Multivan T5, Transporter T5
1 987 482 015	2015	VW (VOLKSWAGEN)	Transporter T5
1 987 482 016	1650	VW (VOLKSWAGEN)	California T5, Caravelle T5, Multivan T5, Transporter T5
1 987 482 017	2015	VW (VOLKSWAGEN)	California T5, Caravelle T5, Multivan T5, Transporter T5

	mm		
1 987 482 025	1152	MERCEDES-BENZ	Vito
1 987 482 026	1285	MERCEDES-BENZ	Vito
1 987 482 027	1468	VW (VOLKSWAGEN)	Crafter 30, Crafter 35, Crafter 50
1 987 482 028	1867	MERCEDES-BENZ	Sprinter
		VW (VOLKSWAGEN)	Crafter 30, Crafter 35, Crafter 50
1 987 482 029	2522	MERCEDES-BENZ	Sprinter
		VW (VOLKSWAGEN)	Crafter 30, Crafter 35, Crafter 50
1 987 482 030	1771	VW (VOLKSWAGEN)	Crafter 30, Crafter 35, Crafter 50
1 987 482 031	2425	VW (VOLKSWAGEN)	Crafter 30, Crafter 35, Crafter 50
1 987 482 032	1666	VW (VOLKSWAGEN)	Crafter 30, Crafter 35
1 987 482 033	1394	VW (VOLKSWAGEN)	Crafter 50
1 987 482 034	1432	VW (VOLKSWAGEN)	Crafter 50
1 987 482 035	1648	FORD	Transit
1 987 482 036	1283	FORD	Transit, Transit Euroline, Nugget, Tourneo
1 987 482 042	508	NISSAN	Primastar
		OPEL	Vivaro
		RENAULT	Trafic
		VAUXHALL	Vivaro
1 987 482 043	1190	NISSAN	Primastar
		OPEL	Vivaro
		RENAULT	Trafic
		VAUXHALL	Vivaro
1 987 482 044	1752	RENAULT	Master
1 987 482 045	1780	RENAULT	Master
1 987 482 046	1137	CITROËN	Jumper
		FIAT	Ducato 10, Ducato 14, Ducato 18
		PEUGEOT	Boxer
1 987 482 066	1888	MITSUBISHI	L 200
1 987 482 067	2350	MITSUBISHI	L 200
1 987 482 068	1996	MITSUBISHI	L 200
1 987 482 069	1993	MITSUBISHI	L 200
1 987 482 108	1776	FIAT	Uno Van
1 987 482 116	600	CITROËN	Berlingo
		PEUGEOT	Partner
1 987 482 117	1627	CITROËN	Berlingo
		PEUGEOT	Partner
1 987 482 118	1718	CITROËN	Jumpy
		FIAT	Scudo
		PEUGEOT	Expert
1 987 482 131	228	MERCEDES-BENZ	Sprinter
		VW (VOLKSWAGEN)	LT
1 987 482 135	1463	FORD	Transit

de

Verwendungsteil

en

Applications

fr

Affectations

it

Impiego

es

Aplicación

Benutzerhinweise

In diesem Katalog sind die Daten von Fahrzeugen, Motoren und Geräten für den europäischen Markt von Baujahr 1985 bis einschließlich 2009 erfasst. Diese wurden aus Hersteller- und Importeurangaben, aus Fahrzeuguntersuchungen sowie aus Unterlagen von Bosch nach bestem Wissen sorgfältig zusammengestellt und geben den Stand zum Zeitpunkt der Drucklegung wieder.

Zwangsläufige Abweichungen durch länder-spezifische technische Änderungen können nie ganz ausgeschlossen werden. Bosch kann daher insoweit nicht für die Vollständigkeit und Fehlerfreiheit der Daten haften. Für Irrtümer und Druckfehler, die zu Schäden am Eigentum oder Vermögen führen, haftet Bosch nur bei grob fahrlässiger Pflichtverletzung und bei Vorsatz für unmittelbare Schäden. Bei Personenschäden haftet Bosch auch bei leichter Fahrlässigkeit.

Notes for users

This catalog contains the data from the vehicles, engines, and equipment for the European market from year of manufacture 1985 up to and including the year 2009. This data has been assembled from information provided by manufacturers and importers, and taken from Bosch documentation, as well as from investigations made on vehicles. It has been compiled to the best of our knowledge and belief, and reflects the status at the date of going to print.

It is impossible to avoid deviations caused by technical changes resulting from the conditions and regulations applying in a particular country. Bosch can therefore accept no liability for the completeness and faultlessness of the data. In case of mistakes and misprints which result in damage to property or assets, Bosch is only liable for immediate damages insofar as a gross breach of duty or wrongful intent apply. If personal injury is involved, Bosch is liable also in case of ordinary negligence.

A l'attention de l'utilisateur

Le présent catalogue mentionne les données spécifiques de véhicules, moteurs et appareils pour le marché européen depuis l'année de fabrication 1985 jusqu'au millésime 2009 inclus. Ces informations ont été rassemblées soigneusement et en toute impartialité à partir des indications des constructeurs et importateurs, des contrôles techniques des véhicules et de la documentation Bosch, et matérialisent le stade des connaissances au moment de la mise sous presse.

Il n'est jamais possible d'exclure totalement les divergences éventuelles dues aux modifications techniques, spécifiques des différents pays considérés. En aucun cas, Bosch n'engage sa responsabilité en ce qui concerne l'intégralité et l'exactitude des données. En ce qui concerne les erreurs et les fautes d'impression, qui peuvent entraîner des dommages à la propriété ou à la fortune, Bosch n'engage sa responsabilité pour les dommages directs qu'en cas d'atteinte et de négligence graves et intentionnelles envers ses obligations. En cas de dommages causés aux personnes, Bosch engage sa responsabilité aussi en cas de légère négligence.

Avvertenze per la consultazione

Nella seguente parte di catalogo sono contemplati veicoli, motori ed apparecchi a partire dall'anno di costruzione 1985 fino all'anno 2009. Tali informazioni sono state rilevate dalle documentazioni di Case Auto, Importatori, da verifiche eseguite sui veicoli, così come da documentazione Bosch.

Eventuali discordanze dovute a specifiche esigenze del Paese e variazioni tecniche non possono essere previste. Per questo Bosch non si assume alcuna responsabilità per mancanze ed eventuali errori riferite ai dati. Per danni a cose o danni patrimoniali, dovuti ad errori o refusi di stampa, Bosch è responsabile solo in caso di dolo o colpa grave. Per danni alla persona, Bosch è responsabile anche in caso di colpa meno grave.

Avertencia al usuario

Los datos de este catálogo para vehículos, motores y utensilios del mercado europeo comprenden los años de construcción desde 1985 hasta 2009 inclusive. Éstos son creados para la edición indicada sobre la base de documentos de Bosch, exámenes o inspecciones de vehículos así como datos de fabricantes e importadores.

No obstante, y debido al cuantioso material de información, no se puede excluir la posibilidad de modificaciones, diferencias propias de variantes específicas de los países, fallos, equivocaciones o errores. En caso de inexactitudes y errores de imprenta, la responsabilidad de Bosch se limita al daño inmediato, con exclusión de un daño puramente patrimonial, a no ser que el daño previsible y típico del contrato sea de mayor monto o se debe a dolo o culpa intencional o a negligencia grave.

Hinweise zur Benutzung

- ① Fahrzeughersteller
- ② Modell
- ③ Modelldetails
- ④ Produktangabe durch Piktogramm
- ⑤ Vorderachse
- ⑥ Hinterachse
- ⑦ System
- ⑧ Einbaueitraum
- ⑨ Bildzeichenerläuterung
- ⑩ Motorleistung in kW
- ⑪ Fahrgestellnummer bzw. Motortyp
- ⑫ Sonderfälle
- ⑬ 10-stellige Bestellnummer
- ⑭ Maßangabe
- ⑮ Links-/rechts-Ausführung
- ⑯ Reparatursatz

B2 | AUSTIN

AUSTIN

Maestro 500/700

1.3 City L
1.6 City L
2.0 City L

01.86-08.88 45/50/63 TW 0 986 480 612 20,6

BEDFORD

Astra

1.4
1.7 D

01.89-09.91 42/55 Fg. Nr. 5567000→

ATE 0 986 473 889 ← 48
DMO 0 986 471 462 ← 48
0 986 473 462
0 986 472 462 → 48
0 986 474 462
CSA ATE 0 986 473 890 → 48

Astramax

1.6
1.7 D

09.85-09.93 42/60

ATE 0 986 473 889 ← 48
DMO 0 986 471 462 ← 48
0 986 473 462
0 986 472 462 → 48
0 986 474 462
CSA ATE 0 986 473 890 → 48

CHEVROLET

Corsa Pick-Up

1.7 D

12.95-02.03 44 1 987 476 691 (340)

1.7 D (GIR) 12.95-02.03 44

CSA, KL 0 986 471 899 ← 48
0 986 473 899 → 48
KL 0 986 471 900 → 48
0 986 473 900
KL 0 986 471 895 ← 48
0 986 473 895 → 48
0 986 471 896 → 48
0 986 473 896

1.7 D

12.95-02.03 44 1 987 476 030 195 0 204 104 208

en

How to use this catalogue

fr

Consignes d'utilisation

it

Istruzioni d'uso

es

Indicaciones para la utilización

① Vehicle brand	① Marque de véhicule	① Marca del veicolo	① Marca de vehículo
② Model	② Modèle	② Modello	② Modelo
③ Details of model	③ Spécification modèle	③ Applicazioni	③ Aplicación
④ Details of product using Pictogram symbols	④ Présentation produit par pictogramme	④ Descrizione prodotto con simboli	④ Indicación de producto con pictogramas
⑤ Front axle	⑤ Essieu avant	⑤ Asse anteriore	⑤ Eje delantero
⑥ Rear axle	④ Essieu arrière	⑥ Asse posteriore	⑥ Eje trasero
⑦ System	⑦ Système	⑦ Sistemi	⑦ Sistema
⑧ Mounting period	⑧ Période de montage	⑧ Data di produzione	⑧ Fecha de montaje
⑨ Explanation of symbols	⑨ Légende des symboles	⑧ Legenda del simboli	⑧ Explicación de símbolo gráfico
⑩ Engine output in kW	⑩ Puissance du moteur en kW	⑩ Potenza motore in kW	⑩ Potencia del motor en kW
⑪ Chassis number or engine type	⑪ Numéros châssis/ moteur	⑪ N° di telaio o tipo di motore	⑪ Número de chasis o número de motor
⑫ Special cases	⑫ Cas particuliers	⑫ Casi particolari	⑫ Casos especiales
⑬ 10-digit part number	⑬ Référence à 10 chiffres	⑬ Codice ordinazione a 10 cifre	⑬ Referencia de pedido de 10 cifras
⑭ Dimensions	⑫ Dimensions	⑫ Dimensioni	⑫ Dimensiones
⑮ Left-hand/Right-hand version	⑮ Version à droite/gauche	⑬ Riferimento sinistra/destra	⑬ Montaje derecha/izquierda
⑯ Repair kit	⑯ Kit de remise en e'tat	⑬ Set riparazione	⑬ Juego de reparación



AUSTIN

Maestro 500/700



	1.3 City L 1.6 City L 2.0 City L	01.86-08.88	45/50/63	TW	0986 480 612	20,6
---	--	-------------	----------	----	--------------	------

BEDFORD

Astra



	1.4 1.7 D	01.89-09.91	42/55		ATE 0986 473 889 DMO 0986 471 462 0986 473 462 0986 472 462 0986 474 462 CSA ATE 0986 473 890	← 48 ← 48 → 48 → 48
---	--------------	-------------	-------	--	--	------------------------------

Astramax





	1.6 1.7 D	09.85-09.93	42/60		ATE 0986 473 889 DMO 0986 471 462 0986 473 462 0986 472 462 0986 474 462 CSA ATE 0986 473 890	← 48 ← 48 → 48 → 48
---	--------------	-------------	-------	--	--	------------------------------

CHEVROLET

Corsa Pick-Up



	1.7 D	12.95-02.03	44		1987 476 691	340
	1.7 D	12.95-02.03	44	CSA, KL KL KL	0986 471 899 0986 473 899 0986 471 900 0986 473 900 0986 471 895 0986 473 895 0986 471 896 0986 473 896	← 48 → 48 ← 48 → 48
	1.7 D	12.95-02.03	44		1987 476 030	195





	1.7D		12.95-02.03	44			0 986 475 143	↔ 19,05
	1.7D	ABO	12.95-02.03	44		LLE	0 986 480 130	20,6
		ABS	12.95-02.03	44		LLE	0 986 480 818	22
	1.7D		12.95-02.03	44			1 987 477 309	← 1378
							1 987 477 310	→ 1086
	1.7D		12.95-02.03	44		Fg.Nr. T3000001→	0 265 216 410 ¹¹	
	1.7D		12.95-02.03	44			0 986 594 025 ⁴	
							0 986 594 028 ³	

CITROEN

Berlingo

	1.6i16V	ESP	08.05→	81			0 204 103 973	← 54
							0 204 103 974	→ 54
		OFD	08.05→	81		BO	0 204 102 971	← 54
							0 204 103 971	
							0 204 102 972	→ 54
							0 204 103 972	
	1.8i		10.99-12.03	74		INB BO	0 204 102 971	← 54
							0 204 103 971	
							0 204 102 972	→ 54
							0 204 103 972	
						LUC	0 986 473 026	← 54
							0 986 474 026	→ 54
						INB	0 986 473 025	← 54
							0 986 474 025	→ 54
	1.6i16V	ABO	08.05→	81			0 204 123 373	23,8
		ABS	08.05→	81			0 204 123 350	23,8
		ESP	08.05→	81			0 204 123 644	23,8
	1.8i	ABO	10.99-06.00	74		Org.Nr. →8609	F 026 003 190	23,8
			07.00-12.03	74		Org.Nr. 8610→	BO 0 204 123 373	23,8
		ABS	10.99-06.00	74		Org.Nr. →8609	LLE F 026 003 192	23,8
			07.00-12.03	74		Org.Nr. 8610→	BO 0 204 123 350	23,8
	1.6i16V		08.05→	81			0 204 125 804	
	1.8i		10.99-06.00	74		Org.Nr. →8609	0 204 125 134	
			07.00-12.03	74		Org.Nr. 8610→	BO 0 204 125 764	
		ABS	10.99-12.03	74			BO 0 204 125 514	
	1.6i16V		08.05→	81		TW	0 986 482 029	
	1.8i		10.99-12.03	74		TW	0 986 482 029	





◀ CITROEN Berlingo

	1.6 i 16V	08.05→	81	Org.Nr. 10221→	0 265 231 523 ¹¹	
					0 265 234 061 ²⁶	
	1.8 i	10.99-12.03	74		0 265 216 721 ¹¹	
	1.8 i	10.99-12.03	74		0 273 004 112 ¹⁶	
	1.6 i 16V	08.05→	81	Org.Nr. 10221→	RAB 0 265 007 883 ⁴	
					LAB 0 265 007 666 ³	
					0 265 007 668 ⁴	
	1.8 i	10.99-05.01	74	Org.Nr. →8938	0 265 006 209 ⁴	
		10.99-12.03	74		0 265 006 200 ³	
		06.01-12.03	74	Org.Nr. 8939→	0 265 006 659 ⁴	

Berlingo [B9]

	1.6 HDi	05.08→	55/66/80		1 987 481 051	450
	1.6 i 16V					
	1.6 HDi	05.08→	55/66/80		1 987 481 052	237
	1.6 i 16V					
	1.6 HDi	05.08-11.08	55/66/80	Org.Nr. →11682	0 265 231 975 ¹¹	
	1.6 i 16V				0 265 235 362 ²⁶	
	1.6 HDi	05.08→	55/66/80		0 265 007 788 ³	
	1.6 i 16V				0 265 007 789 ⁴	
	1.6 HDi	05.08-11.08	55/66/80	Org.Nr. →11682	0 265 005 715	
	1.6 i 16V	12.08→	55/66/80	Org.Nr. 11683→	0 265 005 758	

Berlingo [M49]

	Electrique	07.96-11.02	24/43-44/		1 987 476 651	440
	1.1 i		50-51/52/			
	1.4, i		55/66/80			
	1.6 i 16V					
	1.8 D, i					
	1.9 D					
	2.0 HDi					



	Electrique	10.98-11.02	24			INB	BO	0 204 102 971	← 54
								0 204 103 971	↻
								0 204 102 972	→ 54
								0 204 103 972	↻
							LUC	0 986 473 026	↻ ← 54
								0 986 474 026	↻ → 54
						INB		0 986 473 025	↻ ← 54
								0 986 474 025	↻ → 54
	1.1i	07.96-11.02	44/51/55					0 986 473 025	↻ ← 54
	1.4, i							0 986 474 025	↻ → 54
	1.6i 16V	07.96-11.02	43-44/			INB	BO	0 204 102 971	← 54
	1.8D		50-51/66/					0 204 103 971	↻
	1.8i		80					0 204 102 972	→ 54
	1.9D							0 204 103 972	↻
							LUC	0 986 473 026	↻ ← 54
								0 986 474 026	↻ → 54
						INB		0 986 473 025	↻ ← 54
								0 986 474 025	↻ → 54
	1.9D	07.98-11.02	52/66				BO	0 204 102 971	← 54
	2.0 HDi							0 204 103 971	↻
								0 204 102 972	→ 54
								0 204 103 972	↻
							LUC	0 986 473 026	↻ ← 54
								0 986 474 026	↻ → 54

	Electrique	07.96-11.02	24/43-44/					1 987 476 178	280
	1.1i		50-51/52/						
	1.4, i		55/66/80						
	1.6i 16V								
	1.8D, i								
	1.9D								
	2.0 HDi								

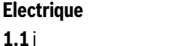
	Electrique	07.96-11.02	24/43-44/					0 986 475 836	↔ 22,19
	1.1i		50-51/52/						
	1.4, i		55/66/80						
	1.6i 16V								
	1.8D, i								
	1.9D								
	2.0 HDi								

	Electrique	ABO	07.96-06.00	24/43-44/	Org.Nr. →8609			F 026 003 190	23,8
	1.1i			51/55/66/80					
			07.00-11.02	24/43-44/	Org.Nr. 8610→		BO	0 204 123 373	23,8
				51/55/66/80					
		ABS	07.96-06.00	24/43-44/	Org.Nr. →8609	LLE		F 026 003 192	23,8
				51/55/66/80		RLE		0 204 123 341	23,8
			07.00-11.02	24/43-44/	Org.Nr. 8610→		BO	0 204 123 350	23,8
				51/55/66/80					
	1.4	ABO	07.96-06.00	24/43-44/	Org.Nr. →8609			F 026 003 190	23,8
	1.4i			51/55/66/80					
			07.00-11.02	24/43-44/	Org.Nr. 8610→		BO	0 204 123 373	23,8
				51/55/66/80					
		ABS	07.96-06.00	24/43-44/	Org.Nr. →8609	LLE		F 026 003 192	23,8
				51/55/66/80		RLE		0 204 123 341	23,8
			07.00-11.02	24/43-44/	Org.Nr. 8610→		BO	0 204 123 350	23,8
				51/55/66/80					



		S									
CITROEN Berlingo [M49]											
1.6 i 16V	ABO	06.00-06.00	24/43-44/ 51/55/66/80	Org.Nr. →8609			F 026 003 190	23,8			
		07.00-11.02	24/43-44/ 51/55/66/80	Org.Nr. 8610→		BO	0 204 123 373	23,8			
ABS	ABO	06.00-06.00	24/43-44/ 51/55/66/80	Org.Nr. →8609	LLE		F 026 003 192	23,8			
					RLE		0 204 123 341	23,8			
		07.00-11.02	24/43-44/ 51/55/66/80	Org.Nr. 8610→		BO	0 204 123 350	23,8			
1.8 D	ABO	07.96-06.00	24/43-44/ 51/55/66/80	Org.Nr. →8609			F 026 003 190	23,8			
		07.00-11.02	24/43-44/ 51/55/66/80	Org.Nr. 8610→		BO	0 204 123 373	23,8			
1.8 i	ABS	07.96-06.00	24/43-44/ 51/55/66/80	Org.Nr. →8609	LLE		F 026 003 192	23,8			
					RLE		0 204 123 341	23,8			
		07.00-11.02	24/43-44/ 51/55/66/80	Org.Nr. 8610→		BO	0 204 123 350	23,8			
1.9 D	ABO	07.96-06.00	50-51/52	Org.Nr. →8609			F 026 003 190	23,8			
		07.00-11.02	50-51/52	Org.Nr. 8610→		BO	0 204 123 373	23,8			
ABS	ABO	07.96-06.00	50-51/52	Org.Nr. →8609	LLE		F 026 003 192	23,8			
					RLE		0 204 123 341	23,8			
		07.00-11.02	50-51/52	Org.Nr. 8610→		BO	0 204 123 350	23,8			
2.0 HDi	ABO	12.99-11.02	66				0 204 123 373	23,8			
		ABS	12.99-11.02	66			0 204 123 350	23,8			
	Electrique	07.96-06.00	24/43-44/ 50-51/55/ 66/80	Org.Nr. →8609			0 204 125 134				
		1.1 i									
1.4, i	ABO	07.00-11.02	24/43-44/ 50-51/55/ 66/80	Org.Nr. 8610→		BO	0 204 125 764				
		1.6 i 16V									
1.8 D, i											
1.9 D											
1.9 D	ABO	07.98-06.00	52	Org.Nr. →8609			0 204 125 134				
		07.00-11.02	52	Org.Nr. 8610→		BO	0 204 125 764				
		09.00-11.02	52				0 204 125 764				
2.0 HDi	ABO	12.99-11.02	66			0 204 125 514					
	1.1 i 1.4, i 1.6 i 16V 1.8 D, i 1.9 D 2.0 HDi	07.96-11.02	43-44/ 50-51/52/ 55/66/80			TW	0 986 482 029				
	1.1 i	07.96-11.99	44	Org.Nr. →8393			1 987 477 576	← 1745			
							1 987 477 577	→ 1818			
		12.99-11.02	44	Org.Nr. 8394→			1 987 477 576	← 1745			
							1 987 477 595	→ 1850			
		06.00-11.02	44				1 987 477 576	← 1745			
							1 987 477 595	→ 1850			
		1.4	ABO	10.96-11.99	51	Org.Nr. →8393			1 987 477 576	← 1745	
									1 987 477 577	→ 1818	
				12.99-11.02	51	Org.Nr. 8394→			1 987 477 576	← 1745	
								1 987 477 595	→ 1850		
		1.4 i	ABO	07.96-11.99	55	Org.Nr. →8393			1 987 477 576	← 1745	
									1 987 477 577	→ 1818	
12.99-11.02	55			Org.Nr. 8394→			1 987 477 576	← 1745			
						1 987 477 595	→ 1850				
06.00-11.02	ABO	55					1 987 477 576	← 1745			
							1 987 477 595	→ 1850			
1.6 i 16V	ABO	06.00-11.02	80				1 987 477 576	← 1745			
							1 987 477 595	→ 1850			

		S							
1.8D		07.96-11.99	43-44/	Org.Nr. →8393			1 987 477 576	← 1745	
1.8i			50-51/66				1 987 477 577	→ 1818	
1.9D		12.99-11.02	43-44/	Org.Nr. 8394→			1 987 477 576	← 1745	
			50-51/66				1 987 477 595	→ 1850	
1.9D		07.98-11.99	52	Org.Nr. →8393			1 987 477 576	← 1745	
							1 987 477 577	→ 1818	
		12.99-11.02	52	Org.Nr. 8394→			1 987 477 576	← 1745	
							1 987 477 595	→ 1850	
		09.00-11.02	52				1 987 477 576	← 1745	
							1 987 477 595	→ 1850	
2.0HDi		12.99-11.02	66				1 987 477 576	← 1745	
							1 987 477 595	→ 1850	

	Electrique	07.96-11.02	24/43-44/				0 265 216 721 ¹¹		
	1.1i		50-51/52/						
	1.4, i		55/66/80						
	1.6 i 16V								
	1.8D, i								
	1.9D								
	2.0HDi								

	Electrique	07.96-11.02	24/43-44/				0 273 004 112 ¹⁶		
	1.1i		50-51/52/						
	1.4, i		55/66/80						
	1.6 i 16V								
	1.8D, i								
	1.9D								
	2.0HDi								

	Electrique	07.96-05.01	24/43-44/	Org.Nr. →8938			0 265 006 209 ⁴		
	1.1i		50-51/52/						
	1.4, i		55/66/80						
	1.6 i 16V	07.96-11.02	24/43-44/				0 265 006 200 ³		
	1.8D, i		50-51/52/						
	1.9D		55/66/80						
	2.0HDi	06.01-11.02	24/43-44/	Org.Nr. 8939→			0 265 006 659 ⁴		
			50-51/52/						
			55/66/80						

Berlingo [M59]













	Electrique	11.02→	28/44/55				1 987 476 651	440	
	1.1i								
	1.4i								
	1.6HDi								
	1.6HDi	ESP 11.02→	66/80				1 987 476 785	455	
	1.6 i 16V	OFD 11.02→	66/80				1 987 476 651	440	
	1.9D	11.02→	52				1 987 476 651	440	
	2.0HDi	ESP 11.02→	66				1 987 476 785	455	
		OFD 11.02→	66				1 987 476 651	440	

	Electrique	11.02→	28/44/55				0 204 102 971	← 54	
	1.1i						0 204 103 971		
	1.4i						0 204 102 972	→ 54	
	1.6HDi						0 204 103 972		



























		S							
◀ CITROEN Berlingo [M59]									
1.6 HDi		ESP	11.02→	66/80			0 204 103 973		← 54
1.6 i 16V							0 204 103 974		→ 54
		OFD	11.02→	66/80			0 204 102 971		← 54
							0 204 103 971		
							0 204 102 972		→ 54
							0 204 103 972		
1.9 D			11.02→	52			0 204 102 971		← 54
							0 204 103 971		
							0 204 102 972		→ 54
							0 204 103 972		
2.0 HDi		ESP	11.02→	66			0 204 103 973		← 54
							0 204 103 974		→ 54
		OFD	11.02→	66			0 204 102 971		← 54
							0 204 103 971		
							0 204 102 972		→ 54
							0 204 103 972		
Electrique			11.02→	28/44/52/			1987 476 178		280
1.1 i									
1.4 i				55/66/80					
1.6 HDi, i 16V									
1.9 D									
2.0 HDi									
Electrique			11.02→	28/44/52/			0986 475 836		↔ 22,19
1.1 i									
1.4 i				55/66/80					
1.6 HDi, i 16V									
1.9 D									
2.0 HDi									
Electrique		ABO	11.02→	28/44/55			0 204 123 373		23,8
1.1 i		ABS	11.02→	28/44/55			0 204 123 350		23,8
1.4 i									
1.6 HDi		ABO	09.05→	28/44/55			0 204 123 373		23,8
				66			0 204 123 373		23,8
		ABS	09.05→	55			0 204 123 350		23,8
				66			0 204 123 350		23,8
		ESP	09.05→	66		LLE	0 204 123 644		23,8
						RLE	0 204 123 645		23,8
1.6 i 16V		ABO	11.02→	80			0 204 123 373		23,8
		ABS	11.02→	80			0 204 123 350		23,8
		ESP	11.02→	80		LLE	0 204 123 644		23,8
						RLE	0 204 123 645		23,8
1.9 D		ABO	11.02→	52			0 204 123 373		23,8
		ABS	11.02→	52			0 204 123 350		23,8
2.0 HDi		ABO	11.02→	66			0 204 123 373		23,8
		ABS	11.02→	66			0 204 123 350		23,8
		ESP	11.02→	66		LLE	0 204 123 644		23,8
						RLE	0 204 123 645		23,8
Electrique			11.02-03.04	28/44	Org.Nr. →9974		RLE	0 204 125 805	
1.1 i			11.02→	28/44			LLE	0 204 125 804	
			04.04→	28/44	Org.Nr. 9975→		RLE	0 204 125 804	
1.4 i			11.02-03.04	55	Org.Nr. →9974		RLE	0 204 125 805	
			11.02→	55			LLE	0 204 125 804	
			04.04→	55	Org.Nr. 9975→		RLE	0 204 125 804	

		S							
1.6 HDi		09.05→	55				0 204 125 804		
			66				0 204 125 804		
1.6 i 16V		11.02-03.04	52/66/80	Org.Nr. →9974	RLE		0 204 125 805		
		11.02→	52/66/80		LLE		0 204 125 804		
		04.04→	52/66/80	Org.Nr. 9975→	RLE		0 204 125 804		
1.9 D		11.02-03.04	52/66/80	Org.Nr. →9974	RLE		0 204 125 805		
2.0 HDi		11.02→	52/66/80		LLE		0 204 125 804		
		04.04→	52/66/80	Org.Nr. 9975→	RLE		0 204 125 804		
 Electrique		11.02→	28/44/55				1 987 477 576	← 1745	
1.1 i							1 987 477 595	→ 1850	
1.4 i									
1.6 HDi									
1.6 HDi		11.02→	66/80		SBR		1 987 482 116	← 600	
1.6 i 16V							1 987 482 117	→ 1627	
					TBR		1 987 477 576	← 1745	
							1 987 477 595	→ 1850	
1.9 D		11.02→	52				1 987 477 576	← 1745	
							1 987 477 595	→ 1850	
2.0 HDi		11.02→	66		SBR		1 987 482 116	← 600	
							1 987 482 117	→ 1627	
					TBR		1 987 477 576	← 1745	
							1 987 477 595	→ 1850	
 Electrique		11.02-11.04	28/44	Org.Nr. →10220			0 265 216 721 ¹¹		
1.1 i		12.04-12.07	28/44	Org.Nr. 10221→11346			0 265 231 523 ¹¹		
1.4 i		11.02-11.04	55	Org.Nr. →10220			0 265 216 721 ¹¹		
		12.04-12.07	55	Org.Nr. 10221→11346			0 265 231 523 ¹¹		
1.6 HDi		09.05-12.07	55	Org.Nr. →11346			0 265 231 523 ¹¹		
			66	Org.Nr. →11346			0 265 231 523 ¹¹		
							0 265 234 061 ²⁶		
1.6 i 16V		11.02-11.04	80	Org.Nr. →10220			0 265 216 721 ¹¹		
							0 265 225 130 ²⁶		
		12.04-12.07	80	Org.Nr. 10221→11346			0 265 231 523 ¹¹		
							0 265 234 061 ²⁶		
1.9 D		11.02-11.04	52	Org.Nr. →10220			0 265 216 721 ¹¹		
		12.04-12.07	52	Org.Nr. 10221→11346			0 265 231 523 ¹¹		
2.0 HDi		11.02-11.04	66	Org.Nr. →10220			0 265 216 721 ¹¹		
							0 265 225 130 ²⁶		
		12.04-12.07	66	Org.Nr. 10221→11346			0 265 231 523 ¹¹		
							0 265 234 061 ²⁶		
 Electrique		11.02-02.03	28/44	Org.Nr. →9582			0 265 006 659 ⁴		
1.1 i		11.02-11.04	28/44	Org.Nr. →10220			0 265 006 200 ³		
		03.03-11.04	28/44	Org.Nr. 9583→10220			0 265 006 793 ⁴		
		12.04-07.05	28/44	Org.Nr. 10221→10478	RAB		0 265 007 667 ⁴		
		12.04→	28/44	Org.Nr. 10221→			0 265 007 666 ³		
					LAB		0 265 007 668 ⁴		
		08.05→	28/44	Org.Nr. 10479→	RAB		0 265 007 883 ⁴		
1.4 i		11.02-02.03	55	Org.Nr. →9582			0 265 006 659 ⁴		
		11.02-11.04	55	Org.Nr. →10220			0 265 006 200 ³		
		03.03-11.04	55	Org.Nr. 9583→10220			0 265 006 793 ⁴		
		12.04-07.05	55	Org.Nr. 10221→10478	RAB		0 265 007 667 ⁴		
		12.04→	55	Org.Nr. 10221→			0 265 007 666 ³		
					LAB		0 265 007 668 ⁴		
		08.05→	55	Org.Nr. 10479→	RAB		0 265 007 883 ⁴		
1.6 HDi		09.05→	55				0 265 007 666 ³		
					LAB		0 265 007 668 ⁴		
					RAB		0 265 007 883 ⁴		
			66				0 265 007 666 ³		
					LAB		0 265 007 668 ⁴		
					RAB		0 265 007 883 ⁴		



		S								
CITROEN Berlingo [M59]										
1.6 i 16V	11.02-02.03	80	Org.Nr. →9582	STB	0 265 006 659 ⁴					
	11.02-11.04	80	Org.Nr. →10220		0 265 006 200 ³					
				SBR	0 265 006 732 ⁴					
	03.03-11.04	80	Org.Nr. 9583→10220	STB	0 265 006 793 ⁴					
	12.04-07.05	80	Org.Nr. 10221→10478	RAB	0 265 007 667 ⁴					
	12.04→	80	Org.Nr. 10221→		0 265 007 666 ³					
				LAB	0 265 007 668 ⁴					
	08.05→	80	Org.Nr. 10479→	RAB	0 265 007 883 ⁴					
	1.9 D	11.02-02.03	52	Org.Nr. →9582		0 265 006 659 ⁴				
		11.02-11.04	52	Org.Nr. →10220		0 265 006 200 ³				
03.03-11.04		52	Org.Nr. 9583→10220		0 265 006 793 ⁴					
12.04-07.05		52	Org.Nr. 10221→10478	RAB	0 265 007 667 ⁴					
12.04→		52	Org.Nr. 10221→		0 265 007 666 ³					
				LAB	0 265 007 668 ⁴					
2.0 HDi	08.05→	52	Org.Nr. 10479→	RAB	0 265 007 883 ⁴					
	11.02-02.03	66	Org.Nr. →9582	STB	0 265 006 659 ⁴					
	11.02-11.04	66	Org.Nr. →10220		0 265 006 200 ³					
				SBR	0 265 006 732 ⁴					
	03.03-11.04	66	Org.Nr. 9583→10220	STB	0 265 006 793 ⁴					
	12.04-07.05	66	Org.Nr. 10221→10478	RAB	0 265 007 667 ⁴					
2.0 HDi	12.04→	66	Org.Nr. 10221→		0 265 007 666 ³					
				LAB	0 265 007 668 ⁴					
	08.05→	66	Org.Nr. 10479→	RAB	0 265 007 883 ⁴					
		1.6 HDi	11.02-12.07	66/80	Org.Nr. →11346	0 265 005 290				
		1.6	01.08→	66/80	Org.Nr. 11347→	0 265 005 758				
		2.0 HDi								
C										
	25 1.9 D	07.87-03.94	51	Org.Nr. →172000		1987 476 548	385			
				Org.Nr. 172000→	OE	1987 476 462	435			
					UE	1987 476 463	435			
	25 1.9 D Turbo	04.92-03.94	60	Org.Nr. 172000→	OE	1987 476 462	435			
					UE	1987 476 463	435			
	25 2.5 D Turbo	08.87-03.94	70	Org.Nr. →172000		1987 476 548	385			
			Org.Nr. 172000→	OE	1987 476 462	435				
				UE	1987 476 463	435				
	25 1.9 D	07.87-03.94	51	Org.Nr. 15548→	L03	0986 473 776	38			
						0986 473 777	38			
	25 1.9 D Turbo	08.87-03.94	60/70			0986 473 779	43			
	25 2.5 D Turbo				CSA	0986 473 778	43			
	25 E 1.8, E 2.0	08.87-03.94	49-51/55-63		L02,VEA	1987 476 688	290			
	25 1.9 D	07.87-03.94	51		L03	1987 476 244	265			
		08.87-03.94	51		L02,VEA	1987 476 688	290			
	25 1.9 D Turbo, 2.5 D	08.87-03.94	54-55/60		L02,VEA	1987 476 688	290			
25 2.5 D Turbo	08.87-03.94	70		L02,VEA	1987 476 688	290				
				L03	1987 476 244	265				
	25 1.9 D	07.87-03.94	51/60/70		L02	0986 475 612	27			
	25 1.9 D Turbo			Org.Nr. 73501→	L03	0986 475 420	25,4			
	25 2.5 D Turbo									

		S							
									
	25 1.9 D	07.87-03.94	51				F 026 003 150	22,19	
	25 E 1.8	08.90-03.94	49-51/		L02		0 204 125 550 ²⁵		
	25 E 2.0		55-63	Org.Nr. 273004→	AS2,L03		0 204 125 420 ²⁵		
	25 1.9 D	07.87-07.90	51		L02		0 204 125 345 ²⁵		
		08.90-03.94	51		L02		0 204 125 550 ²⁵		
				Org.Nr. 273004→	AS2,L03		0 204 125 420 ²⁵		
	25 1.9 D Turbo	04.92-03.94	60				0 204 125 550 ²⁵		
	25 2.5 D	08.90-03.94	54-55		L02		0 204 125 550 ²⁵		
				Org.Nr. 273004→	AS2,L03		0 204 125 420 ²⁵		
	25 2.5 D Turbo	08.87-07.90	70				0 204 125 345 ²⁵		
		08.90-03.94	70				0 204 125 550 ²⁵		
	25 1.9 D	07.87-03.94	51/60/70	Org.Nr. →73500			0 204 131 226 ¹⁰		
	25 1.9 D Turbo								
	25 2.5 D Turbo								
	25 1.9 D	07.87-03.94	51/60/70		ABM,LLE		1 987 477 417	1608	
	25 1.9 D Turbo						1 987 477 419	2338	
	25 2.5 D Turbo				AA		1 987 477 515	↔ 2566	
C 15									
									
	E 1.0	11.86-05.88	32	Org.Nr. →4195			1 987 476 150	370	
		06.88-07.88	32	Org.Nr. 4196→			1 987 476 519	355	
		07.88-12.97	32				1 987 476 519	355	
	E 1.1, i	07.87-12.96	35-40/44/				1 987 476 519	355	
	E 1.3		47						
	E 1.4	07.86-07.87	44/50-51	Org.Nr. →4195			1 987 476 150	370	
		07.87-05.88	40-46	Org.Nr. →4195			1 987 476 150	370	
			51	Org.Nr. →4195			1 987 476 150	370	
		06.88-12.96	40-46	Org.Nr. 4196→			1 987 476 519	355	
			51	Org.Nr. 4196→			1 987 476 519	355	
	E 1.4, i	05.91-12.96	44/52/55-58				1 987 476 519	355	
	1.8 D	07.86-12.05	44/52/55-58				1 987 476 519	355	
	1.9 D								
	E 1.0	06.88-07.88	32	Org.Nr. 4196→			0 986 471 672	← 48	
							0 986 473 672		
							0 986 472 672	→ 48	
							0 986 474 672		
		07.88-12.97	32				0 986 471 672	← 48	
							0 986 473 672		
							0 986 472 672	→ 48	
							0 986 474 672		
	E 1.1	07.87-12.96	35-40/44/				0 986 471 672	← 48	
	E 1.1 i		47				0 986 473 672		
	E 1.3						0 986 472 672	→ 48	
							0 986 474 672		
	E 1.4	06.88-12.96	40-46/51	Org.Nr. 4196→			0 986 471 672	← 48	
							0 986 473 672		
							0 986 472 672	→ 48	
							0 986 474 672		

CITROEN C 15								
E 1.4	07.86-05.00	44/55-58				0986 471 672	← 48	
E 1.4 i						0986 473 672		
1.8 D						0986 472 672	→ 48	
						0986 474 672		
1.9 D	06.00-12.05	52				0204 102 289	← 48	0204 100 062 ⁸
						0986 473 103		0204 104 039 ⁷
						0204 102 290	→ 48	0204 100 062 ⁸
						0986 474 103		
	E 1.0	07.86-12.05	32/35-46/			1987 476 686	205	
	E 1.1, i		47/50-51/					
	E 1.3		52/55-58					
	E 1.4, i							
	1.8 D							
	1.9 D							
	E 1.0	07.86-12.05	32/35-46/			F 026 002 080	↔ 22,19	
	E 1.1, i		47/50-51/					
	E 1.3		52/55-58					
	E 1.4, i							
	1.8 D							
	1.9 D							
	E 1.0	11.86-05.88	32	Org.Nr. →4195	LLE			0204 124 041 ⁶
		11.86-07.88	32	Org.Nr. →4195	RLE	F 026 003 060	19	0204 124 042 ⁶
		06.88-07.88	32	Org.Nr. 4196→	LLE	F 026 003 076	20,6	0204 124 050 ⁶
					RLE	0204 123 113	20,6	
		07.88-12.97	32		LLE	F 026 003 076	20,6	0204 124 050 ⁶
					RLE	0204 123 113	20,6	
	E 1.1	07.87-07.88	35-40			F 026 003 076	20,6	0204 124 050 ⁶
	E 1.1	07.88-12.96	44		LLE	F 026 003 076	20,6	0204 124 050 ⁶
	E 1.1 i				RLE	0204 123 113	20,6	
	E 1.3	07.87-07.88	47			F 026 003 076	20,6	0204 124 050 ⁶
	E 1.4	07.86-07.87	44/50-51			F 026 003 060	19	0204 124 042 ⁶
		07.87-12.96	40-46	Org.Nr. →4195		F 026 003 060	19	0204 124 042 ⁶
			51	Org.Nr. →4195		F 026 003 060	19	0204 124 042 ⁶
		06.88-12.96	40-46	Org.Nr. 4196→	LLE	F 026 003 076	20,6	0204 124 050 ⁶
					RLE	0204 123 113	20,6	
			51	Org.Nr. 4196→	LLE	F 026 003 076	20,6	0204 124 050 ⁶
					RLE	0204 123 113	20,6	
	E 1.4	05.91-12.96	55-58			F 026 003 076	20,6	0204 124 050 ⁶
	E 1.4 i					0204 123 113	20,6	
	1.8 D	07.86-12.05	44/52			F 026 003 076	20,6	0204 124 050 ⁶
	1.9 D							
	E 1.0	07.86-12.05	32/35-46/			0204 131 039 ¹⁰		
	E 1.1, i		47/50-51/					
	E 1.3		52/55-58					
	E 1.4, i							
	1.8 D							
	1.9 D							
	E 1.0	07.86-12.05	32/35-46/		ABM	1987 477 486	1780	
	E 1.1, i		47/50-51/					
	E 1.3		52/55-58					
	E 1.4, i							
	1.8 D							
	1.9 D							



Jumper



	2.8	ABO 12.01→	63/77/93	INB,L02	0 986 473 163	↻ ← 44,95	
	2.8 HDI				0 986 474 163	↻ → 44,95	
	2.8 T				INB,L03	0 986 473 162	↻ ← 40,39
						0 986 474 162	↻ → 40,39
					INB,L03	0 986 473 161	↻ ← 40,39
						0 986 474 161	↻ → 40,39



	2.8	12.01→	63/77/93	APD	0 986 475 906	↔ 26,99
	2.8 HDI			L02	0 986 475 803	↔ 28,6
	2.8 T			L03	0 986 475 801	↔ 25,4
						0 986 475 802



	2.8	12.01→	63/77/93	KL	0 204 123 615	25,4
	2.8 HDI			KL	0 204 123 616	25,4
	2.8 T	ABS 12.01→	63/77/93	L02,LLE	F 026 003 313	25,4

	2.8	12.01→	63/77/93		0 204 125 801	
	2.8 HDI			Fg.Nr. →15064995 L03	0 204 125 445	
	2.8 T			Fg.Nr. 15064996→15984271 L03	0 204 125 746	
				Fg.Nr. 15984272→	0 204 125 772	

	2.8	12.01→	63/77/93	Fg.Nr. 15445358→	L02	0 265 216 530 ¹¹
	2.8 HDI				L03	0 265 216 436 ¹¹
	2.8 T					

	2.8	12.01→	63/77/93	Fg.Nr. 15445358→	LAB	0 265 006 405 ⁴
	2.8 HDI				RAB	0 265 006 406 ⁴
	2.8 T					

Jumper [U5]



	2.0 HDi, i	ABO 02.02→	62/74/80/	UE	1 987 481 004	470
	2.2 HDi		90/94/107			
	2.8 D Turbo, HDi					



	2.0 HDi, i	02.02→	62/74/80/90	SBR	1 987 476 629 ²	160
		ABO 02.02→	62/74/80/90		1 987 481 002 ¹	360
		ABS 02.02→	62/74/80/90	LAB	1 987 481 018 ¹	385
	2.2 HDi			RAB	1 987 481 019 ¹	385
		02.02→	62/74/80/90	SBR	1 987 476 629 ²	160
		ABO 02.02→	62/74/80/90		1 987 481 002 ¹	360
		ABS 02.02→	62/74/80/90	LAB	1 987 481 018 ¹	385
				RAB	1 987 481 019 ¹	385
	2.8 D Turbo	02.02→	62/74/80/90	SBR	1 987 476 629 ²	160
		ABO 02.02→	62/74/80/90		1 987 481 002 ¹	360
		ABS 02.02→	62/74/80/90	LAB	1 987 481 018 ¹	385
				RAB	1 987 481 019 ¹	385





CITROEN Jumper [U5]











	2.8 HDi	02.02→	94/107	SBR	1987 476 629 ²	160
		ABO 02.02→	94/107		1987 481 002 ¹	360
		ABS 02.02→	94/107	LAB	1987 481 018 ¹	385
				RAB	1987 481 019 ¹	385
	2.0 HDi, i	02.02→	62/74/80/	APD	0986 475 906	↔ 26,99
	2.2 HDi		90/94/107			
	2.8 D Turbo, HDi					
	2.0 HDi, i	02.02→	62/74/80/	KL	0204 123 615	25,4
	2.2 HDi		90/94/107	KL	0204 123 616	25,4
	2.8 D Turbo, HDi					
	2.0 HDi, i	02.02→	62/74/80/		0204 125 801	
	2.2 HDi		90/94/107			
	2.8 D Turbo, HDi					

Jumper [U9]













	2.2 HDi	06.06→	74/88/115		1987 482 213	↔ 1593
	3.0 HDi				1987 482 214	↔ 335
	2.2 HDi	06.06-01.07	74/88/115		0265 008 018 ⁴	
	3.0 HDi					

Jumper [23]

	1.9 D	02.94-02.02	51/62/63/64/66-68/76/79/80/90/94		1987 476 329	485
	1.9 D Turbo	ABO 02.94-02.02	51/62/63/64/66-68/76/79/80/90/94	UE	1987 481 063	490
	2.0, HDi	02.94-02.02	51/62/63/64/66-68/76/79/80/90/94		1987 476 329	485
	2.0 i	ABO 02.94-02.02	51/62/63/64/66-68/76/79/80/90/94	UE	1987 481 063	490
	2.5 D, D Turbo	02.94-02.02	51/62/63/64/66-68/76/79/80/90/94		1987 476 329	485
	2.5 TDi	ABO 02.94-02.02	51/62/63/64/66-68/76/79/80/90/94	UE	1987 481 063	490
	2.8 D, D Turbo	01.99-02.02	51/62/63/64/66-68/76/79/80/90/94		1987 476 329	485
	2.8 HDi	ABO 01.99-02.02	51/62/63/64/66-68/76/79/80/90/94	UE	1987 481 063	490
		1.9 D, D Turbo	ABO 02.94-02.02	51/62/63/64/66-68/76/79/80/90/94	INB,L02	0986 473 163
2.0, HDi, i					0986 474 163	↔ 44,95
2.5 D, D Turbo, TDi				INB,L03	0986 473 162	↔ 40,39
2.8 D, D Turbo, HDi					0986 474 162	↔ 40,39
				INB,L03	0986 473 161	↔ 40,39
	1.9 D, D Turbo	ABO 02.94-02.02	51/62/63/64/66-68/76/79/80/90/94	FCC,FEN	1987 481 017	360
				VFC	1987 481 002	360
		ABS 02.94-02.02	51/62/63/64/66-68/76/79/80/90/94	FCC,FEN	1987 476 689	← 335
					1987 481 061	360
						→ 360
				VFC	1987 481 019	385
					→ 385	

		S															
2.0, HDi, i		ABO	02.94-02.02	51/62/63/64/66-68/76/79/80/90/94		FCC,FEN	1 987 481 017	360									
						VFC	1 987 481 002	360									
						ABS	02.94-02.02	51/62/63/64/66-68/ 76/79/80/90/94	FCC,FEN	1 987 476 689	← 335						
										1 987 481 061	360	→ 360					
						VFC	1 987 481 019	385	→ 385								
2.5 D, D Turbo 2.5 TDi		ABO	02.94-02.02	51/62/63/64/66-68/76/79/80/90/94		FCC,FEN	1 987 481 017	360									
						VFC	1 987 481 002	360									
						ABS	02.94-02.02	51/62/63/64/66-68/ 76/79/80/90/94	FCC,FEN	1 987 476 689	← 335						
										1 987 481 061	360	→ 360					
						VFC	1 987 481 019	385	→ 385								
2.8 D, D Turbo 2.8 HDi		ABO	01.99-02.02	51/62/63/64/66-68/76/79/80/90/94		FCC,FEN	1 987 481 017	360									
						VFC	1 987 481 002	360									
						ABS	01.99-02.02	51/62/63/64/66-68/ 76/79/80/90/94	FCC,FEN	1 987 476 689	← 335						
										1 987 481 061	360	→ 360					
						VFC	1 987 481 019	385	→ 385								
	1.9 D, D Turbo 2.0, HDi, i 2.5 D, D Turbo, TDi 2.8 D, D Turbo, HDi		02.94-02.02	51/62/63/ 64/66-68/ 76/79/80/ 90/94		L02	0 986 475 803	↔ 28,6									
						L03	0 986 475 801	↔ 25,4									
							0 986 475 802	↔ 27									
	1.9 D 1.9 D Turbo	ABO	02.94-12.94	51/66-68/79		L03,RLE	0 204 123 319	22,19									
						L02,RLE	0 204 123 314	25,4									
						L03,RLE	0 204 123 325	23,8									
						ABS	02.94-12.94	51/66-68/79	L03	0 204 123 320	22,19						
									L03,LLE	F 026 003 318	22,19						
							02.94-02.02	51/66-68/79		F 026 003 315	25,4						
									L02,LLE	F 026 003 313	25,4						
						2.0	ABO	02.94-12.94	51/66-68/79		L03,RLE	0 204 123 319	22,19				
											L02,RLE	0 204 123 314	25,4				
											L03,RLE	0 204 123 325	23,8				
											ABS	02.94-12.94	51/66-68/79	L03	0 204 123 320	22,19	
														L03,LLE	F 026 003 318	22,19	
							02.94-02.02	51/66-68/79		F 026 003 315	25,4						
						2.0 HDi	ABO	03.01-02.02	62		L02,RLE	0 204 123 314	25,4				
											L03,RLE	0 204 123 325	23,8				
											ABS	03.01-02.02	62	F 026 003 315	25,4		
														L02,LLE	F 026 003 313	25,4	
											2.0 i	ABO	02.94-12.94	63/76/80		L03,RLE	0 204 123 319
						L02,RLE	0 204 123 314	25,4									
						L03,RLE	0 204 123 325	23,8									
ABS	02.94-12.94	63/76/80	L03	0 204 123 320	22,19												
			L03,LLE	F 026 003 318	22,19												
	02.94-02.02	63/76/80		F 026 003 315	25,4												
2.5 D 2.5 D Turbo	ABO	02.94-12.94	63/76/80		L03,RLE	0 204 123 319	22,19										
					L02,RLE	0 204 123 314	25,4										
					L03,RLE	0 204 123 325	23,8										
					ABS	02.94-12.94	63/76/80	L03	0 204 123 320	22,19							
								L03,LLE	F 026 003 318	22,19							
	02.94-02.02	63/76/80		F 026 003 315	25,4												
			L02,LLE	F 026 003 313	25,4												

		S										
◀ CITROEN Jumper [23]												
2.5 TDi	ABO	10.96-02.02	64/79/90/94		L02,RLE	0 204 123 314	25,4					
					L03,RLE	0 204 123 325	23,8					
2.8 D 2.8 D Turbo 2.8 HDi	ABS	10.96-02.02	64/79/90/94			F 026 003 315	25,4					
					L02,LLE	F 026 003 313	25,4					
					L02,RLE	0 204 123 314	25,4					
2.8 D Turbo 2.8 HDi	ABS	01.99-02.02	64/79/90/94		L03,RLE	0 204 123 325	23,8					
					L02,LLE	F 026 003 315	25,4					
	1.9 D	02.94-02.02	51	Fg.Nr. →15064995	L03	0 204 125 445						
					Fg.Nr. 15064996→15984271	L03,LLE	0 204 125 746					
					Fg.Nr. 15687087→15984271	RLE	0 204 125 746					
					Fg.Nr. →15984271	L02,LLE	0 204 125 746					
					Fg.Nr. 15984272→	LLE	0 204 125 772					
						L02,RLE	0 204 125 772					
1.9 D Turbo	01.99-02.02	51	Fg.Nr. →15984271	LLE	0 204 125 746							
				02.94-02.02	66-68	Fg.Nr. →15064995	L03	0 204 125 445				
							Fg.Nr. 15064996→15984271	L03,LLE	0 204 125 746			
							Fg.Nr. 15687087→15984271	RLE	0 204 125 746			
							Fg.Nr. →15984271	L02,LLE	0 204 125 746			
							Fg.Nr. 15984272→	LLE	0 204 125 772			
	L02,RLE	0 204 125 772										
2.0	02.94-02.02	79	Fg.Nr. →15064995	L03	0 204 125 445							
				Fg.Nr. 15064996→15984271	L03	0 204 125 746						
				Fg.Nr. →15984271	L02	0 204 125 746						
				Fg.Nr. 15984272→		0 204 125 772						
				2.0 HDi	03.01-02.02	62	Fg.Nr. →15984271		0 204 125 746			
								Fg.Nr. 15984272→		0 204 125 772		
2.0 i	02.94-02.02	63/76/80	Fg.Nr. →15064995					L03	0 204 125 445			
								Fg.Nr. 15064996→15984271	L03	0 204 125 746		
								Fg.Nr. →15984271	L02	0 204 125 746		
								Fg.Nr. 15984272→		0 204 125 772		
				2.5 D 2.5 D Turbo	02.94-02.02	63/76/80	Fg.Nr. →15064995	L03	0 204 125 445			
								Fg.Nr. 15064996→15984271	L03	0 204 125 746		
Fg.Nr. →15984271	L02	0 204 125 746										
Fg.Nr. 15984272→		0 204 125 772										
2.5 TDi 2.8 D, D Turbo, HDi	10.96-02.02	64/79/90/94	Fg.Nr. →15984271						0 204 125 746			
								Fg.Nr. 15984272→		0 204 125 772		
	1.9 D, D Turbo	ABO	02.94-02.02	51/63/66-68/ 76/79/80		0 204 131 232 ¹⁰						
					12.94-06.97	51/63/ 66-68/76/ 79/80	Fg.Nr. →15445357		0 204 131 217 ¹⁰			
	2.0, i	ABO	02.94-02.02	51/63/66-68/ 76/79/80					0 204 131 232 ¹⁰			
					12.94-06.97	51/63/ 66-68/76/ 79/80	Fg.Nr. →15445357		0 204 131 217 ¹⁰			
	2.5 D 2.5 D Turbo	ABO	02.94-02.02	51/63/66-68/ 76/79/80					0 204 131 232 ¹⁰			
					12.94-06.97	51/63/ 66-68/76/ 79/80	Fg.Nr. →15445357		0 204 131 217 ¹⁰			
	2.5 TDi	ABS	12.94-06.97	51/63/ 66-68/76/ 79/80					0 204 131 217 ¹⁰			
					2.8 D, D Turbo	ABO	01.99-02.02	64/90		0 204 131 232 ¹⁰		

		S							
	1.9 D	02.94-02.02	51/66-68		AA	1 987 482 005	4100		
	1.9 D Turbo				LLE	1 987 477 114	1059		
					RLE	1 987 482 046	1137		
				Fg.Nr. →16158427	AA,FCC, FEN	1 987 477 113	3025		
				Fg.Nr. 16158428→	AA,VFC	1 987 477 115	3040		
					AA,FCC, FEN	1 987 477 262	2806		
					AA,VFC	1 987 482 006	2827		
	2.0	02.94-02.02	79		LLE	1 987 477 114	1059		
				Fg.Nr. →16158427	RLE	1 987 482 046	1137		
					FCC,FEN	1 987 477 113	3025		
			Fg.Nr. 16158428→	VFC	1 987 477 115	3040			
				FCC,FEN	1 987 477 262	2806			
				VFC	1 987 482 006	2827			
2.0 HDi	03.01-02.02	62		AA	1 987 482 005	4100			
				LLE	1 987 477 114	1059			
				RLE	1 987 482 046	1137			
			Fg.Nr. →16158427	AA,FCC, FEN	1 987 477 113	3025			
			Fg.Nr. 16158428→	AA,VFC	1 987 477 115	3040			
				AA,FCC, FEN	1 987 477 262	2806			
				AA,VFC	1 987 482 006	2827			
2.0 i	02.94-02.02	80		LLE	1 987 477 114	1059			
				RLE	1 987 482 046	1137			
			Fg.Nr. →16158427	FCC,FEN	1 987 477 113	3025			
				VFC	1 987 477 115	3040			
			Fg.Nr. 16158428→	FCC,FEN	1 987 477 262	2806			
				VFC	1 987 482 006	2827			
2.5 D	02.94-02.02	63/64/76/		AA	1 987 482 005	4100			
2.5 D Turbo		79/90/94		LLE	1 987 477 114	1059			
2.5 TDi				RLE	1 987 482 046	1137			
2.8 D			Fg.Nr. →16158427	AA,FCC, FEN	1 987 477 113	3025			
2.8 D Turbo				AA,VFC	1 987 477 115	3040			
2.8 HDi			Fg.Nr. 16158428→	AA,FCC, FEN	1 987 477 262	2806			
				AA,VFC	1 987 482 006	2827			
	1.9 D, D Turbo	02.94-02.02	51/62/63/	Fg.Nr. 15445358→	L02	0 265 216 530 ¹¹			
	2.0, HDi, i		64/66-68/		L03	0 265 216 436 ¹¹			
	2.5 D, D Turbo, TDi		76/79/80/						
	2.8 D, D Turbo, HDi		90/94						
	1.9 D, D Turbo	02.94-02.02	51/62/63/	Fg.Nr. 15445358→	L03	1 273 004 168 ¹⁶			
	2.0, HDi, i		64/66-68/						
	2.5 D, D Turbo, TDi		76/79/80/						
	2.8 D, D Turbo, HDi		90/94						
	1.9 D	02.94-04.00	51/66-68/	Fg.Nr. 15445358→		0 265 006 427 ³			
	1.9 D Turbo		79						
	2.0	02.94-02.02	51/66-68/	Fg.Nr. 15445358→	LAB	0 265 006 405 ⁴			
			79		RAB	0 265 006 406 ⁴			
	2.0 HDi	03.01-02.02	62	Fg.Nr. 15445358→	LAB	0 265 006 405 ⁴			
					RAB	0 265 006 406 ⁴			
	2.0 i	02.94-04.00	63/64/76/	Fg.Nr. 15445358→		0 265 006 427 ³			
	2.5 D, D Turbo, TDi		79/80/90						
	2.8 D, D Turbo	02.94-02.02	63/64/76/	Fg.Nr. 15445358→	LAB	0 265 006 405 ⁴			
			79/80/90		RAB	0 265 006 406 ⁴			
	2.8 HDi	09.00-02.02	94	Fg.Nr. 15445358→	LAB	0 265 006 405 ⁴			
					RAB	0 265 006 406 ⁴			

















Jumpy [G9]

	1.6 HDi	02.07→	66			0986 475 950	↔	
	1.6 HDi	02.07→	66	FKR,SBR	1987 482 007	↔ 1614		
				FLR,SBR	1987 482 008	↔ 1737		
				TBR	1987 482 118	↔ 1718		
	2.0 HDi, i 16V	02.07→	88/100/103	FKR	1987 482 007	↔ 1614		
				FLR	1987 482 008	↔ 1737		
	1.6 HDi	08.07-07.08	66/88/100/	Org.Nr. 11208→11556		0265 234 213 ²⁶		
	2.0 HDi		103					
	2.0 i 16V	08.08→	66/88/100/	Org.Nr. 11557→		0265 230 078 ²⁶		
			103					
	1.6 HDi	02.07→	66/88/100/			0265 007 790 ³		
	2.0 HDi		103			0265 007 791 ⁴		
	2.0 i 16V							
	1.6 HDi	02.07-11.07	66/88/100/	Org.Nr. →11318		0265 005 606		
	2.0 HDi		103					
	2.0 i 16V	12.07-07.08	66/88/100/	Org.Nr. 11319→11556		0265 005 724		
			103					
		12.08→	66/88/100/	Org.Nr. 11683→		0265 005 765		
			103					

Jumpy [U64]

	1.6 i	10.95-09.03	50-52/58	Org.Nr. →9792		1987 476 951	470	
	1.9 D							
	1.9 D	10.98→	51/52			1987 476 951	470	
	1.9 D Turbo	10.95-09.03	66/67-68/	Org.Nr. →9792		1987 476 951	470	
	2.0 HDi		70/80/81/					
	2.0 i		100					
	1.6 i	10.95→	50-52/58/		BSY	0204 102 521	← 57	0204 100 316 ⁸
	1.9 D		66/67-68/			0204 103 521		0204 104 177 ⁷
	1.9 D Turbo		70/80/81/			0204 102 523	→ 57	0204 100 316 ⁸
	2.0 HDi		100			0204 103 523		
	2.0 i				LUC	0986 473 115	← 57,1	
						0986 474 115	→ 57,1	
	1.6 i	10.95→	50-52/58/66/67-68/			1987 476 947 ¹	250	
	1.9 D, D Turbo		70/80/81/100					
	2.0 HDi, i							
	1.6 i	10.95→	50-52/58/66/67-68/			F 026 002 181	↔ 19,05	
	1.9 D, D Turbo		70/80/81/100					
	2.0 HDi, i							

		S							
									
	1.6 i	ABO	10.95-05.99	58	Org.Nr. →8206		F 026 003 166	23,8	
			06.99→	58	Org.Nr. 8207→		F 026 003 188	22,19	0 204 124 059 ⁶
							F 026 003 188	22,19	
							F 026 003 517	23,8	
	ABS	10.95-05.99	58	Org.Nr. →8206			F 026 003 518	22,19	0 204 124 136 ⁶
			06.99→	58	Org.Nr. 8207→		0 204 123 182	23,8	
							F 026 003 516	23,8	
							F 026 003 518	22,19	
	1.9 D	ABO	10.95-05.99	50-52	Org.Nr. →8206		F 026 003 166	23,8	
			06.99→	50-52	Org.Nr. 8207→		F 026 003 188	22,19	0 204 124 059 ⁶
							F 026 003 188	22,19	
			09.01→	52			F 026 003 517	23,8	
							F 026 003 517	23,8	
	ABS	10.95-05.99	50-52	Org.Nr. →8206			F 026 003 518	22,19	0 204 124 136 ⁶
			06.99→	50-52	Org.Nr. 8207→		0 204 123 182	23,8	
							F 026 003 516	23,8	
							F 026 003 518	22,19	
	1.9 D Turbo	ABO	10.95-05.99	66/67-68	Org.Nr. →8206		F 026 003 166	23,8	
			06.99→	66/67-68	Org.Nr. 8207→		F 026 003 188	22,19	0 204 124 059 ⁶
							F 026 003 188	22,19	
							F 026 003 517	23,8	
	ABS	10.95-05.99	66/67-68	Org.Nr. →8206			F 026 003 518	22,19	0 204 124 136 ⁶
			06.99→	66/67-68	Org.Nr. 8207→		0 204 123 182	23,8	
							F 026 003 516	23,8	
							F 026 003 518	22,19	
	2.0 HDi	ABO	10.99→	70/80/81			F 026 003 517	23,8	
	ABS	10.99→	70/80/81				F 026 003 516	23,8	
	2.0 i	ABO	04.00→	100			F 026 003 517	23,8	
	ABS	04.00→	100				F 026 003 516	23,8	
	1.6 i		10.95→	50-52/58/		FCC,LLE	0 204 125 714		
	1.9 D			66/67-68		FCC,LLE BSY	0 204 125 715		
	1.9 D Turbo						0 204 125 716		
						RLE	0 204 125 109		
	2.0 HDi		10.99→	70/80/81/		FCC,LLE	0 204 125 714		
	2.0 i			100		FCC,LLE BSY	0 204 125 715		
						RLE	0 204 125 109		
	1.6 i		10.95→	50-52/58/66/67-68/			0 204 131 085 ¹⁰		
	1.9 D, D Turbo			70/80/81/100					
	2.0 HDi, i								
	1.6 i		10.95→	50-52/58/		FKR	1 987 477 565	500	
	1.9 D			66/67-68/		FLR	1 987 477 774	900	
	1.9 D Turbo			70/80/81/		LLE	1 987 477 568	← 1063	
	2.0 HDi			100			1 987 477 569	→ 2286	
	2.0 i					RLE	1 987 477 568	← 1063	
							1 987 477 773	→ 2368	
	1.6 i		06.97-05.99	50-52/58	Org.Nr. 7481→8420		0 265 216 496 ¹¹		
	1.9 D		06.99→	50-52/58	Org.Nr. 8421→		0 265 216 725 ¹¹		
	1.9 D		09.01→	52			0 265 216 725 ¹¹		
	1.9 D Turbo		06.97-05.99	66/67-68	Org.Nr. 7481→8420		0 265 216 496 ¹¹		
			06.99→	66/67-68	Org.Nr. 8421→		0 265 216 725 ¹¹		
	2.0 HDi, i		10.99→	70/80/81/100			0 265 216 725 ¹¹		





◀ CITROEN Jumpy [U64]

	1.6 i	06.97-09.97	50-52/58	Org.Nr. 7481→7601	0 265 006 426 ⁴	
	1.9 D	06.97-08.01	50-52/58	Org.Nr. 7481→9050	0 265 006 388 ³	
		10.97-08.01	50-52/58	Org.Nr. 7602→9050	0 265 006 504 ⁴	
		09.01→	50-52/58	Org.Nr. 9051→	0 265 006 730 ³	
					0 265 006 731 ⁴	
	1.9 D	10.98-08.01	51		0 265 006 388 ³	
					0 265 006 504 ⁴	
		09.01→	52		0 265 006 730 ³	
					0 265 006 731 ⁴	
	1.9 D Turbo	06.97-09.97	66/67-68	Org.Nr. 7481→7601	0 265 006 426 ⁴	
		06.97-08.01	66/67-68	Org.Nr. 7481→9050	0 265 006 388 ³	
		10.97-08.01	66/67-68	Org.Nr. 7602→9050	0 265 006 504 ⁴	
		09.01→	66/67-68	Org.Nr. 9051→	0 265 006 730 ³	
					0 265 006 731 ⁴	
	2.0 HDi	10.99-08.01	70/80/81/	Org.Nr. →9050	0 265 006 388 ³	
	2.0 i		100		0 265 006 504 ⁴	
			09.01→	70/80/81/	Org.Nr. 9051→	0 265 006 730 ³
			100		0 265 006 731 ⁴	

Nemo [A9]



	1.4 HDi	02.08→	50		1987 482 207	→ 1650
					1987 482 208	← 1584
	1.4 i	02.08→	54		1987 482 205	→ 1604
					1987 482 206	← 1555

EBRO (MISA)

L



	60 .09	05.85-06.90	69/72/88/		0 204 123 241	28,57
	80, Turbo, .09, .14		99			

Trade



	2.8	05.85-02.87	56		0 204 162 048	
	2.8	05.85-02.87	56		0 204 163 055	

FIAT

Cityvan [257..]



	1.1	01.85-08.89	43/44		1987 476 881	384
	1.7 D					



	1.1 1.7 D	01.85-08.89	43/44			1 987 476 954 ¹	255	
	1.1 1.7 D	01.85-08.89	43/44			F 026 002 454	↔ 19,05	
	1.1 1.7 D	01.85-08.89	43/44		BSY	0 204 032 347		
	1.1 1.7 D	01.85-08.89	43/44			0 204 131 223		
	1.1 1.7 D	01.85-08.89	43/44			1 987 477 296	2828	

Doblo Cargo [223..]

	1.2 i.e. 8V 1.3 JTD 16V 1.6 i.e. 16V, i.e. 16V Bipower 1.9D, JTD	07.00-09.05	46/47/51/ 68-76/77			1 987 476 879	504	
	1.2 i.e. 8V	07.00-09.05	47		MIH	0 986 473 125	↻ ← 54	
						0 986 474 125	↻ → 54	
	1.3 JTD	10.05→	55/62		FCC,FEN, KOB	0 204 004 566	← 54	
						0 204 004 567	→ 54	
				Ricam.Nr →5749151	KOB,VAN,	0 204 004 564	← 54	
					VFC	0 204 004 565	→ 54	
				Ricam.Nr 5749152→	KOB,VAN,	0 204 902 119	←	
					VFC	0 204 902 120	→	
	1.3 JTD 16V	02.04-09.05	51		MIH	0 986 473 125	↻ ← 54	
						0 986 474 125	↻ → 54	
	1.4 i.e.	10.05→	57		FCC,FEN, KOB	0 204 004 566	← 54	
						0 204 004 567	→ 54	
				Ricam.Nr →5749151	KOB,VAN,	0 204 004 564	← 54	
					VFC	0 204 004 565	→ 54	
				Ricam.Nr 5749152→	KOB,VAN,	0 204 902 119	←	
					VFC	0 204 902 120	→	
	1.6 i.e. 16V Bipower	10.05→	76			0 204 004 564	← 54	
						0 204 004 565	→ 54	
	1.6 i.e. 16V	10.01-09.05	68-76		MIH	0 986 473 125	↻ ← 54	
	1.6 i.e. 16V Bipower					0 986 474 125	↻ → 54	
	1.9D	07.00-09.05	46		MIH	0 986 473 125	↻ ← 54	
						0 986 474 125	↻ → 54	





FIAT Doblo Cargo [223..]

1.9 JTD	10.01-01.04	74	MIH	0986 473 125	← 54
				0986 474 125	→ 54
	11.02-09.05	77	MIH	0986 473 125	← 54
				0986 474 125	→ 54
	10.05→	74		0204 004 564	← 54
				0204 004 565	→ 54
		77	FCC,FEN, KOB	0204 004 566	← 54
				0204 004 567	→ 54
			Ricam.Nr →5749151	0204 004 564	← 54
				0204 004 565	→ 54
			Ricam.Nr 5749152→	0204 902 119	←
				0204 902 120	→
		88	FCC,FEN, KOB	0204 004 566	← 54
				0204 004 567	→ 54
			Ricam.Nr →5749151	0204 004 564	← 54
				0204 004 565	→ 54
			Ricam.Nr 5749152→	0204 902 119	←
				0204 902 120	→

	1.2 i.e. 8V	07.00→	46/47/51/	ZE	1987 476 125	465
	1.3 JTD, JTD 16V		55/57/62/			
	1.4 i.e.		74/76/77			
	1.6 i.e. 16V, i.e. 16V Bipower					
	1.9 D, JTD					

F

	1.2 i.e. 8V	07.00-09.05	47		0986 475 901	↔ 20,64
		02.04-09.05	47	APD	0986 475 816	↔ 20,64
	1.3 JTD	10.05→	55/62		0986 475 936	↔ 20,64
		1.3 JTD 16V	02.04-09.05	51	ATE	0986 475 901
APD	0986 475 816				↔ 20,64	
	1.4 i.e.	10.05→	57		0986 475 936	↔ 20,64
	1.6 i.e. 16V	10.01-09.05	76		0986 475 901	↔ 20,64
		02.04-09.05	76	APD	0986 475 816	↔ 20,64
	1.6 i.e. 16V Bipower	01.03-09.05	68-76	ATE	0986 475 901	↔ 20,64
		02.04-09.05	68-76	APD	0986 475 816	↔ 20,64
		10.05→	76		0986 475 936	↔ 20,64
	1.9 D	07.00-09.05	46		0986 475 901	↔ 20,64
		02.04-09.05	46	APD	0986 475 816	↔ 20,64
	1.9 JTD	10.01-01.04	74		0986 475 901	↔ 20,64
		11.02-09.05	77	ATE	0986 475 901	↔ 20,64
		02.04-09.05	77	APD	0986 475 816	↔ 20,64
		10.05→	74		0986 475 936	↔ 20,64
			77		0986 475 936	↔ 20,64
			88		0986 475 936	↔ 20,64

	1.2 i.e. 8V	A BO	07.00-09.05	47	LLE	0986 480 866	22
		1.3 JTD	A BO	10.05-06.08	55/62	LLE	0204 123 714
			ABS	10.05→	55/62	LLE	0204 123 713
	1.3 JTD 16V	A BO	02.04-09.05	51	LLE	0986 480 866	22
	1.4 i.e.	A BO	10.05-06.08	57	LLE	0204 123 712	22,19
		ABS	10.05-06.08	57	LLE	0204 123 711	22,19
	1.6 i.e. 16V Bipower	A BO	10.05-06.08	76	LLE	0204 123 712	22,19
		ABS	10.05-06.08	76	LLE	0204 123 711	22,19
	1.6 i.e. 16V	A BO	10.01-09.05	68-76	LLE	0986 480 866	22
	1.6 i.e. 16V Bipower						
	1.9 D	A BO	07.00-09.05	46	LLE	0986 480 866	22

		S							
1.9 JTD	ABO	10.01-09.05	74/77			LLE	0 986 480 866	22	
		10.05-06.08	74/77			LLE	0 204 123 714	23,8	
	ABS	10.05→	74/77			LLE	0 204 123 713	23,8	
1.3 JTD		10.05-06.08	55/62			LLE	0 204 125 856		
1.4 i.e.		10.05-06.08	57/76			LLE	0 204 125 866		
1.6 i.e. 16V Bipower									
1.9 JTD		10.05-06.08	74/77			LLE	0 204 125 856		
1.3 JTD 16V		07.00-09.05	46/51/			LLE	0 986 486 091		
1.6 i.e. 16V, i.e. 16V Bipower			68-76/77						
1.9 D, JTD									
1.3 JTD, 16V		02.04→	51/55/62				0 986 486 556		
1.4 i.e.		10.05→	57/68-76			LLE	0 986 486 563		
						RLE	0 986 486 556		
1.6 i.e. 16V Bipower		10.05→	46/76				0 986 486 556		
1.6 i.e. 16V, i.e. 16V Bipower		10.01-09.05	57/68-76			LLE	0 986 486 563		
						RLE	0 986 486 556		
1.9 D		07.00-09.05	46/76				0 986 486 556		
1.9 JTD		10.01-01.04	74				0 986 486 556		
						RLE	0 986 486 556		
		11.02→	77/88				0 986 486 556		
		10.05→	74				0 986 486 556		
1.2 i.e. 8V		07.00→	46/47/51/			KOB	1 987 477 723	↔ 1810	
1.3 JTD, JTD 16V			55/57/62/						
1.4 i.e.			74/76/77/						
1.6 i.e. 16V			88						
1.9 D, JTD									

Ducato

2.5 D		11.97-12.99	62				0 986 475 802	↔ 27	
2.8 D		04.00-05.05	63				0 986 475 802	↔ 27	
2.8 D Turbo, D Turbo Interc.		04.00-04.02	90/103,3				0 986 475 802	↔ 27	
2.5 D	ABO	11.97-12.99	62				F 026 003 313	25,4	
	ABS	11.97-12.99	62				F 026 003 315	25,4	
2.8 D	ABO	04.00-05.05	63				F 026 003 313	25,4	
	ABS	04.00-05.05	63				F 026 003 315	25,4	
2.8 D Turbo		05.02-05.05	90/103,3				0 204 123 615	25,4	
2.8 D Turbo Interc.	ABO	04.00-04.02	90/103,3				F 026 003 313	25,4	
	ABS	04.00-04.02	90/103,3				F 026 003 315	25,4	
2.8 JTD Combinato, JTD Maxi Cargo	ABO	06.05-08.09	93				0 204 123 616	25,4	
JTD Minibus, JTD Multi T.A., JTD Multi T.B.	ABS	06.05-08.09	93				0 204 123 615	25,4	
2.5 D		11.97-12.99	62				0 204 125 746		
2.8 D		04.00-05.05	63				0 204 125 746		
2.8 D Turbo		04.00-10.00	90				0 204 125 746		
		11.00-04.02	90				0 204 125 772		
		05.02-05.05	90				0 204 125 801		
2.8 D Turbo Interc.		10.00-04.02	103,3				0 204 125 772		
		05.02-05.05	103,3				0 204 125 801		
2.8 JTD Combinato, JTD Maxi Cargo		06.05-08.09	93				0 204 125 801		
JTD Minibus, JTD Multi T.A. JTD Multi T.B.									





FIAT Ducato

	2.5 D	11.97-12.99	62	1987 477 114	1059
	2.8 D	04.00-05.05	63	1987 477 114	1059
	2.8 D Turbo	04.00-04.02	90	1987 477 114	1059
		05.02-05.05	90	1987 482 002	1078
	2.8 D Turbo Interc.	10.00-04.02	103,3	1987 477 114	1059
	2.8 JTD Combinato, JTD Maxi Cargo JTD Minibus, JTD Multi T.A. JTD Multi T.B.	06.05-08.09	93	1987 482 003	2715

	2.8 JTD Combinato, JTD Maxi Cargo JTD Minibus, JTD Multi T.A. JTD Multi T.B.	06.05-08.09	93	0 265 006 673 ³	
				LAB 0 265 006 688 ⁴	
				RAB 0 265 006 689 ⁴	

Ducato Cargo



	2.5 D	11.97-05.05	62/63	0 986 475 803	↔ 28,6
	2.8 D				
	2.8 D Turbo 2.8 D Turbo Interc.	04.00-04.02	90/103,3	0 986 475 803	↔ 28,6



	2.5 D	ABO	11.97-05.05	62	F 026 003 313	25,4
		ABS	11.97-05.05	62	F 026 003 315	25,4
	2.8 D	ABO	04.00-05.05	63	F 026 003 313	25,4
			01.04-05.05	63	0 204 123 616	25,4
		ABS	04.00-05.05	63	F 026 003 315	25,4
			01.04-05.05	63	0 204 123 615	25,4
	2.8 D Turbo		05.02-05.05	90	0 204 123 615	25,4
		ABO	04.00-04.02	90	F 026 003 313	25,4
			01.04-05.05	90	0 204 123 616	25,4
		ABS	04.00-04.02	90	F 026 003 315	25,4
			01.04-05.05	90	0 204 123 615	25,4
		2.8 D Turbo Interc.	05.02-05.05	103,3	0 204 123 615	25,4
	2.8 D Turbo Interc.	ABO	10.00-04.02	103,3	F 026 003 313	25,4
			ABS	10.00-04.02	103,3	F 026 003 315
		2.8 JTD	ABO	06.05-08.09	93	0 204 123 616
		ABS	06.05-08.09	93	0 204 123 615	25,4

	2.8 D	01.04-05.05	63	0 204 125 801	
	2.8 D Turbo	11.00-04.02	90	0 204 125 772	
		05.02-05.05	90	0 204 125 801	
		2.8 D Turbo Interc.	10.00-04.02	103,3	0 204 125 772
		05.02-05.05	103,3	0 204 125 801	
	2.8 JTD	06.05-08.09	93	0 204 125 801	

	2.5 D	11.97-05.05	62	1987 477 114	1059
	2.8 D	04.00-05.05	63	1987 477 114	1059
		01.04-05.05	63	1987 482 003	2715
		2.8 D Turbo	04.00-04.02	90	1987 477 114
		05.02-05.05	90	1987 482 002	1078
		01.04-05.05	90	1987 482 003	2715
	2.8 D Turbo Interc.	10.00-04.02	103,3	1987 477 114	1059
		05.02-05.05	103,3	1987 482 002	1078
2.8 JTD	06.05-08.09	93	1987 482 003	2715	

	2.8 D	01.04-08.09	63/90/93	0 265 006 673 ³	
	2.8 D Turbo			LAB 0 265 006 688 ⁴	
	2.8 JTD			RAB 0 265 006 689 ⁴	



Ducato Maxi 17 [251..]

	2.3 JTD	06.06→	88/96/116		0 204 902 000	← 48	
	3.0 JTD				0 204 902 001	→ 48	
	2.3 JTD	ESP 06.06→	88/96	GS	0 204 123 721	26,9	
				HAG	0 204 123 725	26,9	
	3.0 JTD	OFD 06.06→	88/96	GS	0 204 123 720	26,9	
				HAG	0 204 123 724	26,9	
	2.3 JTD	ESP 06.06→	116	GS	0 204 123 721	26,9	
				HAG	0 204 123 725	26,9	
3.0 JTD	OFD 06.06→	116	GS	0 204 123 720	26,9		
			HAG	0 204 123 724	26,9		
	2.3 JTD	06.06→	88/96/116	BSS	0 204 125 860		
	3.0 JTD			BSS	0 204 125 861		
	2.3 JTD	06.06→	88/96/116	FKR,FMR	1 987 482 213	↔ 1593	
	3.0 JTD			FLR	1 987 482 214	↔ 335	
	2.3 JTD	06.06-01.08	88/96/116		0 265 231 618 ¹¹		
	3.0 JTD				0 265 233 330 ¹⁴		
	2.3 JTD	06.06→	88/96/116	GS	0 265 234 069 ²⁶		
	3.0 JTD						
	2.3 JTD	06.06→	88/96/116		0 265 007 685 ³		
	3.0 JTD			FLR	0 265 007 833 ⁴		

Ducato Maxi 20 [251..]

	2.3 JTD	06.06→	88/96/116		0 204 902 000	← 48	
	3.0 JTD				0 204 902 001	→ 48	
	2.3 JTD	ESP 06.06→	88/96	GS	0 204 123 721	26,9	
				HAG	0 204 123 725	26,9	
	3.0 JTD	OFD 06.06→	88/96	GS	0 204 123 720	26,9	
				HAG	0 204 123 724	26,9	
	2.3 JTD	ESP 06.06→	116	GS	0 204 123 721	26,9	
				HAG	0 204 123 725	26,9	
3.0 JTD	OFD 06.06→	116	GS	0 204 123 720	26,9		
			HAG	0 204 123 724	26,9		
	2.3 JTD	06.06→	88/96/116	BSS	0 204 125 860		
	3.0 JTD			BSS	0 204 125 861		
	2.3 JTD	06.06→	88/96/116	FKR,FMR	1 987 482 213	↔ 1593	
	3.0 JTD			FLR	1 987 482 214	↔ 335	





◀ FIAT Ducato Maxi 20 [251..]

	2.3 JTD	06.06-01.08	88/96/116		0 265 231 618 ¹¹	
	3.0 JTD				0 265 233 330 ¹⁴	
		06.06→	88/96/116	GS	0 265 234 069 ²⁶	
	2.3 JTD	06.06→	88/96/116		0 265 007 685 ³	
	3.0 JTD			FLR	0 265 007 833 ⁴	

Ducato 10 [230..]













	1.9 D	ABO 03.94-10.01	50/51	OE	1 987 476 329	485
				UE	1 987 481 063	490
		ABS 03.94-02.00	50/51		1 987 476 329	485
	1.9 TD	ABO 03.94-10.01	60/66	OE	1 987 476 329	485
				UE	1 987 481 063	490
		ABS 03.94-02.00	60/66		1 987 476 329	485
	1.9 TD CAT	ABO 03.94-03.98	59/62/63/ 64/79/80/85	OE	1 987 476 329	485
				UE	1 987 481 063	490
		ABS 03.94-03.98	59/62/63/ 64/79/80/85		1 987 476 329	485
	2.0	ABO 03.94-03.02	59/62/63/ 64/79/80/85	OE	1 987 476 329	485
				UE	1 987 481 063	490
	2.0 i.e.					
	2.0 JTD	ABS 03.94-03.02	59/62/63/64/79/80/85		1 987 476 329	485
	2.5 D	ABO 03.94-03.98	59/62/63/ 64/79/80/85	OE	1 987 476 329	485
				UE	1 987 481 063	490
	2.5 TD ECO					
	2.5 TD EGR	ABS 03.94-03.98	59/62/63/64/79/80/85		1 987 476 329	485
	2.8 D	ABO 04.98-03.02	59/62/63/64/79/80/85	OE	1 987 476 329	485
				UE	1 987 481 063	490
		ABS 04.98-03.02	59/62/63/64/79/80/85		1 987 476 329	485
	2.8 JTD, JTD EGR	ABO 08.00-03.02	94	OE	1 987 476 329	485
	2.8 TD	ABO 10.97-03.02	90	OE	1 987 476 329	485
	2.8 TD EGR			UE	1 987 481 063	490
			ABS 10.97-03.02	90		1 987 476 329

	1.9 D, TD, TD CAT	ABO 03.94-03.02	50/51/59/ 60/62/63/ 66/79/80		0 986 473 161	← 40,39
	2.0, i.e., JTD				0 986 474 161	→ 40,39
	2.5 D					
	2.5 TD ECO	ABO 03.94-03.98	80/85		0 986 473 162	← 40,39
	2.5 TD EGR				0 986 474 162	→ 40,39
	2.8 D	ABO 04.98-03.02	64		0 986 473 161	← 40,39
						0 986 474 161
	2.8 TD	ABO 10.97-03.02	90		0 986 473 162	← 40,39
	2.8 TD EGR				0 986 474 162	→ 40,39



	1.9 D	ABO 03.94-10.01	50/51	FEN	1 987 481 017 ¹	360
		ABS 03.94-03.98	51	FEN,LAB	1 987 476 689 ¹	335
				LVF	1 987 481 018 ¹	385
				RNF	1 987 481 061	360
					1 987 481 061 ¹	360
				RVF	1 987 481 019 ¹	385
		04.98-10.01	50	FEN,LAB	1 987 476 689 ¹	335
				RNF	1 987 481 061	360
					1 987 481 061 ¹	360

		S										
1.9 TD	ABO	03.94-10.01	60/66			FEN	1 987 481 017 ¹	360				
	ABS	03.94-10.01	60/66			FEN,LAB	1 987 476 689 ¹	335				
						LVF	1 987 481 018 ¹	385				
						RNF	1 987 481 061	360				
							1 987 481 061 ¹	360				
1.9 TD CAT	ABO	03.94-03.98	59			FEN	1 987 481 017 ¹	360				
	ABS	03.94-03.98	59			FEN,LAB	1 987 476 689 ¹	335				
						LVF	1 987 481 018 ¹	385				
						RNF	1 987 481 061	360				
							1 987 481 061 ¹	360				
2.0, i.e., JTD	ABO	03.94-03.02	63/79/80			FEN	1 987 481 017 ¹	360				
	2.5 D	ABO	03.94-03.98	62/64/80/85			FEN	1 987 481 017 ¹	360			
		ABS	03.94-03.98	62/64/80/			FEN,LAB	1 987 476 689 ¹	335			
		2.5 TD ECO					RNF	1 987 481 061	360			
								1 987 481 061 ¹	360			
2.5 TD EGR			85				1 987 481 061 ¹	360				
							1 987 481 061 ¹	360				
2.8 D	ABO	04.98-03.02	62/64/80/85			FEN	1 987 481 017 ¹	360				
	ABS	04.98-03.02	62/64/80/			FEN,LAB	1 987 476 689 ¹	335				
			85			RNF	1 987 481 061	360				
						1 987 481 061 ¹	360					
2.8 TD	ABS	10.97-03.02	90			FEN,LAB	1 987 476 689 ¹	335				
						LVF	1 987 481 018 ¹	385				
						RNF	1 987 481 061	360				
							1 987 481 061 ¹	360				
							1 987 481 019 ¹	385				
2.8 TD EGR	ABS	10.97-03.02	90			FEN,LAB	1 987 476 689 ¹	335				
						RNF	1 987 481 061	360				
							1 987 481 061 ¹	360				
2.8 TD	ABO	10.97-03.02	90			FEN	1 987 481 017 ¹	360				
2.8 TD EGR												
	1.9 D, TD, TD CAT	03.94-03.02	50/51/59/				0 986 475 802	↔ 27				
	2.0, i.e.		60/62/66/									
	2.5 D		79/80									
	2.5 TD ECO	03.94-03.98	80/85			KOB	0 986 475 801	↔ 25,4				
	2.5 TD EGR					KW	0 986 475 802	↔ 27				
	2.8 D	04.98-03.02	64				0 986 475 802	↔ 27				
2.8 JTD, JTD EGR, TD, TD EGR	10.97-03.02	90/94				0 986 475 801	↔ 25,4					
	1.9 D	ABO	03.94-03.98	51	Fg.Nr. →5064996	LLE	F 026 003 318	22,19				
						RLE	0 204 123 319	22,19				
							Fg.Nr. 5064997→	RLE	0 204 122 270	23,8		
			04.98-10.01	50	Fg.Nr. 5687088→5984271	RLE	0 204 122 270	23,8				
					Fg.Nr. 5984272→	LLE	F 026 003 313	25,4				
			09.00-10.01	50	Fg.Nr. 5984272→	RLE	0 204 123 325	23,8				
		ABS	03.94-03.98	51	Fg.Nr. →5064996		0 204 123 320	22,19				
						Fg.Nr. 5064997→	F 026 003 315	25,4				
			04.98-10.01	50			F 026 003 315	25,4				
		1.9 TD	ABO	03.94-03.98	60	Fg.Nr. →5064996	LLE	F 026 003 318	22,19			
							RLE	0 204 123 319	22,19			
								Fg.Nr. 5064997→	RLE	0 204 122 270	23,8	
				04.98-10.01	66	Fg.Nr. 5687088→5984271	RLE	0 204 122 270	23,8			
						Fg.Nr. 5984272→	LLE	F 026 003 313	25,4			
	09.00-10.01		66	Fg.Nr. 5984272→	RLE	0 204 123 325	23,8					
ABS	03.94-03.98		60	Fg.Nr. →5064996		0 204 123 320	22,19					
					Fg.Nr. 5064997→	F 026 003 315	25,4					
	04.98-10.01	66			F 026 003 315	25,4						













FIAT Ducato 10 [230..]

1.9 TD CAT	ABO	03.94-03.98	59	Fg.Nr. →5064996	LLE	F 026 003 318	22,19
					RLE	0 204 123 319	22,19
				Fg.Nr. 5064997→	RLE	0 204 122 270	23,8
ABS	03.94-03.98	59	Fg.Nr. →5064996		0 204 123 320	22,19	
			Fg.Nr. 5064997→		F 026 003 315	25,4	
2.0	ABO	03.94-08.00	79/80	Fg.Nr. 5687088→5984271	RLE	0 204 123 325	23,8
2.0 i.e.		03.94-03.02	79/80	Fg.Nr. →5064996	LLE	F 026 003 318	22,19
					RLE	0 204 123 319	22,19
				Fg.Nr. 5064997→5687087	RLE	0 204 122 270	23,8
				Fg.Nr. 5984272→6194400	LLE	F 026 003 313	25,4
				Fg.Nr. 6194401→		0 204 123 616	25,4
ABS	03.94-03.02	79/80	Fg.Nr. →5064996		0 204 123 320	22,19	
			Fg.Nr. 5064997→6194400		F 026 003 315	25,4	
			Fg.Nr. 6194401→		0 204 123 615	25,4	
2.0 JTD	ABO	10.01-03.02	63	Fg.Nr. →6194400	LLE	F 026 003 313	25,4
				Fg.Nr. 6194401→		0 204 123 616	25,4
ABS	10.01-03.02	63	Fg.Nr. →6194400		F 026 003 315	25,4	
			Fg.Nr. 6194401→		0 204 123 615	25,4	
2.5 D	ABO	03.94-03.98	62/80/85	Fg.Nr. →5064996	LLE	F 026 003 318	22,19
					RLE	0 204 123 319	22,19
2.5 TD ECO				Fg.Nr. 5064997→	RLE	0 204 122 270	23,8
2.5 TD EGR	ABS	03.94-03.98	62/80/85	Fg.Nr. →5064996		0 204 123 320	22,19
				Fg.Nr. 5064997→		F 026 003 315	25,4
2.8 D	ABO	04.98-08.00	64	Fg.Nr. 5687088→5984271	RLE	0 204 123 325	23,8
					RLE	0 204 122 270	23,8
		04.98-03.02	64	Fg.Nr. 5064997→5687087	RLE	0 204 122 270	23,8
				Fg.Nr. 5984272→6194400	LLE	F 026 003 313	25,4
				Fg.Nr. 6194401→		0 204 123 616	25,4
ABS	04.98-03.02	64	Fg.Nr. →6194400		F 026 003 315	25,4	
			Fg.Nr. 6194401→		0 204 123 615	25,4	
2.8 JTD	ABO	08.00-03.02	94	Fg.Nr. 6194401→		0 204 123 616	25,4
2.8 JTD EGR		09.00-11.01	94	Fg.Nr. 5984272→6194400	LLE	F 026 003 313	25,4
						F 026 003 315	25,4
ABS	08.00-03.02	94	Fg.Nr. →6194400		F 026 003 315	25,4	
			Fg.Nr. 6194401→		0 204 123 615	25,4	
2.8 TD	ABO	10.97-08.00	90	Fg.Nr. 5687088→5984271	RLE	0 204 123 325	23,8
					LLE	F 026 003 318	22,19
		10.97-03.02	90	Fg.Nr. →5064996	RLE	0 204 123 319	22,19
				Fg.Nr. 5064997→5687087	RLE	0 204 122 270	23,8
				Fg.Nr. 5984272→	LLE	F 026 003 313	25,4
				Fg.Nr. 6194401→	RLE	F 026 003 313	25,4
ABS	10.97-03.02	90	Fg.Nr. →5064996		0 204 123 320	22,19	
			Fg.Nr. 5064997→		F 026 003 315	25,4	
2.8 TD EGR	ABO	10.97-08.00	90	Fg.Nr. 5687088→5984271	RLE	0 204 123 325	23,8
					RLE	0 204 122 270	23,8
		10.97-03.02	90	Fg.Nr. 5064997→5687087	RLE	0 204 122 270	23,8
				Fg.Nr. 6194401→		0 204 123 616	25,4
		09.00-11.01	90	Fg.Nr. 5984272→6194400	LLE	F 026 003 313	25,4
ABS	10.97-03.02	90	Fg.Nr. →5064997		F 026 003 315	25,4	
			Fg.Nr. 6194401→		0 204 123 615	25,4	



1.9 D	ABO	03.94-03.98	51	Fg.Nr. →5064996		0 204 125 445	
						0 204 125 746	
ABS	04.98-08.00	50	Fg.Nr. 5687088→5984271	LLE	0 204 125 746		
				LLE	0 204 125 772		
		09.00-10.01	50	Fg.Nr. 5984272→	RLE	0 204 125 773	
ABS	04.98-08.00	50	Fg.Nr. 5687088→5984271		0 204 125 746		
			Fg.Nr. 5984272→		0 204 125 772		
1.9 TD	ABO	03.94-03.98	60	Fg.Nr. →5064996		0 204 125 445	
					LLE	0 204 125 746	
ABS	04.98-08.00	66	Fg.Nr. 5687088→5984271	LLE	0 204 125 746		
				LLE	0 204 125 772		
		09.00-10.01	66	Fg.Nr. 5984272→	RLE	0 204 125 773	
ABS	04.98-08.00	66	Fg.Nr. 5687088→5984271		0 204 125 746		
			Fg.Nr. 5984272→		0 204 125 772		
1.9 TD CAT		03.94-03.98	59	Fg.Nr. →5064996		0 204 125 445	

		S							
2.0		03.94-08.00	79/80		Fg.Nr. 5687088→5984271		0 204 125 746		
2.0 i.e.		03.94-03.02	79/80		Fg.Nr. →5064996		0 204 125 445		
					Fg.Nr. 5984272→6194400		0 204 125 772		
					Fg.Nr. 6194401→		0 204 125 801		
	ABO	12.01-03.02	79/80		Fg.Nr. 6194401→		0 204 024 593 ²⁵		
	ABS	03.94-03.02	79/80		Fg.Nr. 6194401→		0 204 024 592 ²⁵		
2.0 JTD		10.01-03.02	63		Fg.Nr. →6194400		0 204 125 772		
					Fg.Nr. 6194401→		0 204 125 801		
	ABO	12.01-03.02	63		Fg.Nr. 6194401→		0 204 024 593 ²⁵		
	ABS	10.01-03.02	63		Fg.Nr. 6194401→		0 204 024 592 ²⁵		
2.5 D, TD ECO, TD EGR		03.94-03.98	62/80/85		Fg.Nr. →5064996		0 204 125 445		
2.8 D		04.98-08.00	64		Fg.Nr. 5687088→5984271		0 204 125 746		
		04.98-03.02	64		Fg.Nr. 5984272→6194400		0 204 125 772		
					Fg.Nr. 6194401→		0 204 125 801		
2.8 JTD		08.00-03.02	94		Fg.Nr. →6194400		0 204 125 772		
2.8 JTD EGR					Fg.Nr. 6194401→		0 204 125 801		
	ABO	12.01-03.02	94		Fg.Nr. 6194401→		0 204 024 593 ²⁵		
	ABS	08.00-03.02	94		Fg.Nr. 6194401→		0 204 024 592 ²⁵		
2.8 TD		10.97-08.00	90		Fg.Nr. 5687088→5984271		0 204 125 746		
		10.97-03.02	90		Fg.Nr. →5064996		0 204 125 445		
					Fg.Nr. 5984272→		0 204 125 772		
2.8 TD EGR		10.97-08.00	90		Fg.Nr. 5687088→5984271		0 204 125 746		
		10.97-03.02	90		Fg.Nr. 5984272→		0 204 125 772		
1.9 D	ABO	03.94-03.98	51			LAB,WIF	0 204 031 056 ¹⁰		
						RAB	0 204 131 232 ¹⁰		
		04.98-10.01	50			KOB	0 204 131 232 ¹⁰		
	ABS	03.94-07.97	51		Fg.Nr. →5445358		0 204 031 050 ¹⁰		
1.9 TD	ABO	03.94-10.01	60/66			LAB,WIF	0 204 031 056 ¹⁰		
						RAB	0 204 131 232 ¹⁰		
	ABS	03.94-07.97	60		Fg.Nr. →5445358		0 204 031 050 ¹⁰		
1.9 TD CAT	ABO	03.94-03.98	59			LAB,WIF	0 204 031 056 ¹⁰		
						RAB	0 204 131 232 ¹⁰		
	ABS	03.94-07.97	59		Fg.Nr. →5445358		0 204 031 050 ¹⁰		
2.0	ABO	03.94-03.02	79/80				0 204 131 232 ¹⁰		
2.0 i.e.	ABS	03.94-07.97	79/80		Fg.Nr. →5445358		0 204 031 050 ¹⁰		
2.0 JTD	ABO	10.01-03.02	63		Fg.Nr. 5048611→		0 204 131 232 ¹⁰		
2.5 D	ABO	03.94-03.98	62/80			KOB	0 204 131 232 ¹⁰		
2.5 TD ECO	ABS	03.94-07.97	62/80		Fg.Nr. →5445358		0 204 031 050 ¹⁰		
2.5 TD EGR	ABO	03.94-03.98	85				0 204 131 232 ¹⁰		
	ABS	03.94-07.97	85		Fg.Nr. →5445358		0 204 031 050 ¹⁰		
2.8 D	ABO	04.98-03.02	64			KOB	0 204 131 232 ¹⁰		
2.8 JTD, JTD EGR	ABO	08.00-03.02	94				0 204 131 232 ¹⁰		
2.8 TD		10.97-03.02	90				0 204 131 232 ¹⁰		
	ABO	10.97-03.02	90			LAB,WIF	0 204 031 056 ¹⁰		
2.8 TD EGR	ABO	10.97-03.02	90				0 204 131 232 ¹⁰		
1.9 D		04.98-10.01	50			LLE	1 987 477 114	1059	
						RLE	1 987 482 046	1137	
					Fg.Nr. →6158428	FEN	1 987 477 113	3025	
1.9 D		03.94-10.01	51/59/60/			LLE	1 987 477 114	1059	
1.9 TD			66			RLE	1 987 482 046	1137	
1.9 TD CAT					Fg.Nr. →6158428	FEN	1 987 477 113	3025	
						FEV	1 987 477 115	3040	
2.0		03.94-11.01	79			LLE	1 987 477 114	1059	
						RLE	1 987 482 046	1137	
					Fg.Nr. 6158429→	FEN	1 987 477 262	2806	
		03.94-03.02	79		Fg.Nr. →6158428	FEN	1 987 477 113	3025	
		12.01-03.02	79			SBR	1 987 482 003	2715	
						TBR	1 987 477 263	2827	



FIAT Ducato 10 [230..]

2.0 i.e.	03.94-11.01	80		LLE	1987	477 114	1059
				RLE	1987	482 046	1137
			Fg.Nr. 6158429→	FEN	1987	477 262	2806
	03.94-03.02	80	Fg.Nr. →6158428	FEN	1987	477 113	3025
12.01-03.02	80			LLE	1987	482 002	1078
				RLE	1987	482 004	1170
				SBR	1987	482 003	2715
				TBR	1987	477 263	2827
				LLE	1987	477 114	1059
				RLE	1987	482 046	1137
				FEN	1987	477 113	3025
2.0 JTD	10.01-11.01	63		LLE	1987	477 114	1059
				RLE	1987	482 046	1137
				FEN	1987	477 113	3025
	10.01-03.02	63	Fg.Nr. →6158428	FEV	1987	477 115	3040
2.5 D	03.94-03.98	62/80		LLE	1987	477 114	1059
				RLE	1987	482 046	1137
2.5 TD ECO				FEN	1987	477 113	3025
				FEN	1987	477 262	2806
2.5 TD EGR	03.94-03.98	85		LLE	1987	477 114	1059
				RLE	1987	482 046	1137
				FEN	1987	477 113	3025
				FEV	1987	477 115	3040
				FEN	1987	477 262	2806
				FEV	1987	482 006	2827
				FEN	1987	477 113	3025
2.8 D	04.98-11.01	64		LLE	1987	477 114	1059
				RLE	1987	482 046	1137
				FEN	1987	477 262	2806
				FEN	1987	477 113	3025
				LLE	1987	482 002	1078
				RLE	1987	482 004	1170
				SBR	1987	482 003	2715
2.8 JTD	08.00-11.01	94		LLE	1987	477 114	1059
				RLE	1987	482 046	1137
				FEN	1987	477 262	2806
				FEV	1987	482 006	2827
				FEN	1987	477 113	3025
				FEV	1987	477 115	3040
				FEN	1987	477 113	3025
2.8 JTD EGR	08.00-03.02	94	Fg.Nr. →6158428	LLE	1987	482 002	1078
				RLE	1987	482 004	1170
				SBR	1987	482 003	2715
				TBR	1987	477 263	2827
				LLE	1987	477 114	1059
				RLE	1987	482 046	1137
				FEN	1987	477 262	2806
2.8 TD	10.97-11.01	90		LLE	1987	477 114	1059
				RLE	1987	482 046	1137
				FEN	1987	477 262	2806
				FEV	1987	477 115	3040
				FEN	1987	477 113	3025
				FEV	1987	477 115	3040
				FEN	1987	477 113	3025
2.8 TD EGR	10.97-11.01	90		LLE	1987	482 002	1078
				RLE	1987	482 004	1170
				SBR	1987	482 003	2715
				TBR	1987	477 263	2827
				LLE	1987	477 114	1059
				RLE	1987	482 046	1137
				FEN	1987	477 262	2806
12.01-03.02	90			LLE	1987	482 002	1078
				RLE	1987	482 004	1170
				SBR	1987	482 003	2715
				TBR	1987	477 263	2827
				LLE	1987	482 002	1078
				RLE	1987	482 004	1170
				SBR	1987	482 003	2715



1.9 D, TD, TD CAT	08.97-10.01	50/51/59/60/66	Fg.Nr. 5445359→6194400	L06,L07	BO	0 265	216 436¹¹
2.0, i.e., JTD	08.97-11.01	63/79/80	Fg.Nr. 5445359→6194400	L06,L07	BO	0 265	216 436¹¹
	12.01-03.02	63/79/80	Fg.Nr. 6194401→		BO	0 265	216 709¹¹



2.5 D, TD ECO, TD EGR	08.97-03.98	62/80/85	Fg.Nr. 5445359→6194400	L06,L07	BO	0 265 216 436 ¹¹
2.8 D, JTD, JTD EGR, TD, TD EGR	10.97-11.01	64/90/94	Fg.Nr. 5445359→6194400	L06,L07	BO	0 265 216 436 ¹¹
	12.01-03.02	64/90/94	Fg.Nr. 6194401→		BO	0 265 216 709 ¹¹

	1.9 D, TD, TD CAT	08.97-11.01	50/51/59/	Fg.Nr. 5445359→6194400	L06,L07	BO	1 273 004 168 ¹⁶
	2.0 i.e., JTD		60/62/63/				
	2.5 D, TD ECO, TD EGR		64/66/79/				
	2.8 D, JTD, JTD EGR, TD, TD EGR		80/85/90/94				





















	1.9 D	04.98-10.01	50	Fg.Nr. 5445359→	LAB	BO	0 265 006 405 ⁴
					RAB	BO	0 265 006 406 ⁴
				Fg.Nr. 5445359→5946342		BO	0 265 006 427 ³
				Fg.Nr. 5946343→		BSY	0 265 006 673 ³
1.9 D	08.97-03.98	51/60	Fg.Nr. 5445359→	LAB	BO	0 265 006 405 ⁴	
1.9 TD				RAB	BO	0 265 006 406 ⁴	
			Fg.Nr. 5445359→5946342		BO	0 265 006 427 ³	
1.9 TD	04.98-10.01	66	Fg.Nr. 5445359→	LAB	BO	0 265 006 405 ⁴	
				RAB	BO	0 265 006 406 ⁴	
			Fg.Nr. 5445359→5946342		BO	0 265 006 427 ³	
			Fg.Nr. 5946343→		BSY	0 265 006 673 ³	
1.9 TD CAT	08.97-03.98	59	Fg.Nr. 5445359→	LAB	BO	0 265 006 405 ⁴	
				RAB	BO	0 265 006 406 ⁴	
			Fg.Nr. 5445359→5946342		BO	0 265 006 427 ³	
2.0	03.94-03.02	79/80	Fg.Nr. 5946343→		BSY	0 265 006 673 ³	
2.0 i.e.	08.97-11.01	79/80	Fg.Nr. 5445359→	LAB	BO	0 265 006 405 ⁴	
				RAB	BO	0 265 006 406 ⁴	
	08.97-03.02	79/80	Fg.Nr. 5445359→5946342		BO	0 265 006 427 ³	
	12.01-03.02	79/80		LAB		0 265 006 688 ⁴	
				RAB		0 265 006 689 ⁴	
2.0 JTD	10.01-11.01	63	Fg.Nr. 5445359→	LAB	BO	0 265 006 405 ⁴	
				RAB	BO	0 265 006 406 ⁴	
	10.01-03.02	63	Fg.Nr. 5946343→		BSY	0 265 006 673 ³	
	12.01-03.02	63		LAB		0 265 006 688 ⁴	
				RAB		0 265 006 689 ⁴	
2.5 D, TD ECO, TD EGR	08.97-03.98	62/80/85	Fg.Nr. 5445359→	LAB	BO	0 265 006 405 ⁴	
				RAB	BO	0 265 006 406 ⁴	
			Fg.Nr. 5445359→5946342		BO	0 265 006 427 ³	
2.8 D	04.98-11.01	64	Fg.Nr. 5445359→	LAB	BO	0 265 006 405 ⁴	
				RAB	BO	0 265 006 406 ⁴	
	04.98-03.02	64	Fg.Nr. 5445359→5946342		BO	0 265 006 427 ³	
			Fg.Nr. 5946343→		BSY	0 265 006 673 ³	
	12.01-03.02	64		LAB		0 265 006 688 ⁴	
				RAB		0 265 006 689 ⁴	
2.8 JTD	08.00-11.01	94	Fg.Nr. 5445359→	LAB	BO	0 265 006 405 ⁴	
2.8 JTD EGR				RAB	BO	0 265 006 406 ⁴	
	08.00-03.02	94	Fg.Nr. 5946343→		BSY	0 265 006 673 ³	
	12.01-03.02	94		LAB		0 265 006 688 ⁴	
				RAB		0 265 006 689 ⁴	
2.8 TD	10.97-11.01	90	Fg.Nr. 5445359→	LAB	BO	0 265 006 405 ⁴	
2.8 TD EGR				RAB	BO	0 265 006 406 ⁴	
	10.97-03.02	90	Fg.Nr. 5445359→5946342		BO	0 265 006 427 ³	
			Fg.Nr. 5946343→		BSY	0 265 006 673 ³	
	12.01-03.02	90		LAB		0 265 006 688 ⁴	
				RAB		0 265 006 689 ⁴	

Ducato 10 [234..]



	2.0 i.e. Bipower CNG 4x4	ABO	03.94-03.02	80/85/90/94	OE	1 987 476 329	485
					UE	1 987 481 063	490
		ABS	03.94-03.02	80/85/90/94		1 987 476 329	485



									
	◀ FIAT Ducato 10 [234..]								
2.5 TD EGR 4x4	ABO	03.94-03.98	80/85/90/94		OE	1987	476 329	485	
2.5 TD 4x4					UE	1987	481 063	490	
	ABS	03.94-03.98	80/85/90/94			1987	476 329	485	
2.8 JTD EGR 4x4, JTD 4x4	ABO	10.97-03.02	80/85/90/94		OE	1987	476 329	485	
2.8 TD EGR 4x4, TD 4x4					UE	1987	481 063	490	
	ABS	10.97-03.02	80/85/90/94			1987	476 329	485	
	2.0 i.e. Bipower CNG 4x4	ABO	03.94-03.02	80		0986	473 161	40,39	
						0986	474 161	40,39	
	2.5 TD EGR 4x4, TD 4x4	ABO	03.94-03.02	85/90/94		0986	473 162	40,39	
	2.8 JTD EGR 4x4, JTD 4x4					0986	474 162	40,39	
	2.8 TD EGR 4x4, TD 4x4								
									
	2.0 i.e. Bipower CNG 4x4	ABO	03.94-03.02	80	FEN	1987	481 017¹	360	
		ABS	03.94-03.02	80	FEN,LAB	1987	476 689¹	335	
					RNF	1987	481 061	360	
						1987	481 061¹	360	
	2.5 TD EGR 4x4, TD 4x4	ABO	03.94-03.98	85	FEN	1987	481 017¹	360	
	2.8 JTD EGR 4x4	ABS	10.97-03.02	90/94	FEN,LAB	1987	476 689¹	335	
	2.8 JTD 4x4				LVF	1987	481 018¹	385	
	2.8 TD EGR 4x4				RNF	1987	481 061	360	
	2.8 TD 4x4					1987	481 061¹	360	
					RVF	1987	481 019¹	385	
	2.0 i.e. Bipower CNG 4x4		03.94-03.02	80/85/90/94		0986	475 802		
	2.5 TD EGR 4x4, TD 4x4								
	2.8 JTD EGR 4x4, JTD 4x4								
	2.8 TD EGR 4x4, TD 4x4								
									
	2.0 i.e. Bipower CNG 4x4	ABO	03.94-08.00	80	Fg.Nr. 5687088→5984271	RLE	0 204 123 325	23,8	
			03.94-03.02	80	Fg.Nr. →5064996	LLE	F 026 003 318	22,19	
						RLE	0 204 123 319	22,19	
					Fg.Nr. 5064997→5687087	RLE	0 204 122 270	23,8	
					Fg.Nr. 5984272→6194400	LLE	F 026 003 313	25,4	
					Fg.Nr. 6194401→		0 204 123 616	25,4	
		ABS	03.94-03.02	80	Fg.Nr. →5064996		0 204 123 320	22,19	
					Fg.Nr. 5064997→6194400		F 026 003 315	25,4	
					Fg.Nr. 6194401→		0 204 123 615	25,4	
	2.5 TD EGR 4x4	ABO	03.94-03.98	85	Fg.Nr. →5064996	LLE	F 026 003 318	22,19	
						RLE	0 204 123 319	22,19	
					Fg.Nr. 5064997→	RLE	0 204 122 270	23,8	
		ABS	03.94-03.98	85	Fg.Nr. →5064996		0 204 123 320	22,19	
					Fg.Nr. 5064997→		F 026 003 315	25,4	
	2.5 TD 4x4	ABO	03.94-03.98	85	Fg.Nr. →5064996	LLE	F 026 003 318	22,19	
						RLE	0 204 123 319	22,19	
					Fg.Nr. 5064997→5687087	RLE	0 204 122 270	23,8	
		ABS	03.94-03.98	85	Fg.Nr. →5064996		0 204 123 320	22,19	
					Fg.Nr. 5064997→5687087		F 026 003 315	25,4	
	2.8 JTD EGR 4x4	ABO	08.00-03.02	94	Fg.Nr. 5984272→6194400	LLE	F 026 003 313	25,4	
	2.8 JTD 4x4				Fg.Nr. 6194401→		0 204 123 616	25,4	
		ABS	08.00-03.02	94	Fg.Nr. →6194400		F 026 003 315	25,4	
					Fg.Nr. 6194401→		0 204 123 615	25,4	
	2.8 TD EGR 4x4	ABO	10.97-08.00	90	Fg.Nr. 5687088→5984271	RLE	0 204 123 325	23,8	
	2.8 TD 4x4		10.97-03.02	90	Fg.Nr. 5064997→5687087	RLE	0 204 122 270	23,8	
					Fg.Nr. 6194401→		0 204 123 616	25,4	
			09.00-11.01	90	Fg.Nr. 5984272→6194400	LLE	F 026 003 313	25,4	
		ABS	10.97-03.02	90			F 026 003 315	25,4	
					Fg.Nr. 6194401→		0 204 123 615	25,4	



	2.0 i.e. Bipower CNG 4x4	03.94-08.00	80	Fg.Nr. 5687088→5984271		0 204 125 746
		03.94-03.02	80	Fg.Nr. →5064996		0 204 125 445
				Fg.Nr. 5984272→6194400		0 204 125 772
				Fg.Nr. 6194401→		0 204 125 801
		ABO 12.01-03.02	80	Fg.Nr. 6194401→		0 204 024 593 ²⁵
		ABS 03.94-03.02	80	Fg.Nr. 6194401→		0 204 024 592 ²⁵
	2.5 TD EGR 4x4	03.94-03.98	85	Fg.Nr. →5064996		0 204 125 445
	2.5 TD 4x4					
	2.8 JTD EGR 4x4	08.00-03.02	94	Fg.Nr. 5984272→6194400		0 204 125 772
	2.8 JTD 4x4			Fg.Nr. 6194401→		0 204 125 801
	ABO 12.01-03.02	94	Fg.Nr. 6194401→		0 204 024 593 ²⁵	
	ABS 08.00-03.02	94	Fg.Nr. 6194401→		0 204 024 592 ²⁵	
2.8 TD EGR 4x4	10.97-08.00	90	Fg.Nr. 5687088→5984271		0 204 125 746	
2.8 TD 4x4	10.97-03.02	90	Fg.Nr. 5984272→		0 204 125 772	

	2.0 i.e. Bipower CNG 4x4	ABO 03.94-03.02	80		KOB	0 204 131 232 ¹⁰
		ABS 03.94-07.97	80	Fg.Nr. →5445358		0 204 031 050 ¹⁰
	2.5 TD EGR 4x4, TD 4x4	ABO 03.94-07.97	85	Fg.Nr. →5445358		0 204 031 050 ¹⁰
	2.8 JTD EGR 4x4, JTD 4x4	ABO 08.00-03.02	94			0 204 131 232 ¹⁰
	2.8 TD EGR 4x4	ABO 10.97-03.02	90		LAB,WIF	0 204 031 056 ¹⁰
2.8 TD 4x4				RAB	0 204 131 232 ¹⁰	

	2.0 i.e. Bipower CNG 4x4	03.94-11.01	80		FEV	1 987 477 115	3040	
					FMR	1 987 477 113	3025	
					LLE	1 987 477 114	1059	
					RLE	1 987 482 046	1137	
					LLE	1 987 482 002	1078	
		12.01-03.02	80			RLE	1 987 482 004	1170
						SBR	1 987 482 003	2715
						TBR	1 987 477 263	2827
	2.5 TD EGR 4x4	03.94-03.98	85		FEV	1 987 477 115	3040	
					FMR	1 987 477 113	3025	
					LLE	1 987 477 114	1059	
					RLE	1 987 482 046	1137	
	2.5 TD 4x4	03.94-03.98	85		FMR	1 987 477 113	3025	
					LLE	1 987 477 114	1059	
					RLE	1 987 482 046	1137	
				Fg.Nr. →6158428	FEV	1 987 477 115	3040	
2.8 JTD EGR 4x4	10.97-11.01	90/94		FEV	1 987 477 115	3040		
2.8 JTD 4x4				FMR	1 987 477 113	3025		
2.8 TD EGR 4x4				LLE	1 987 477 114	1059		
2.8 TD 4x4				RLE	1 987 482 046	1137		
	12.01-03.02	90/94		LLE	1 987 482 002	1078		
				RLE	1 987 482 004	1170		
				SBR	1 987 482 003	2715		
				TBR	1 987 477 263	2827		

	2.0 i.e. Bipower CNG 4x4	08.97-11.01	80	Fg.Nr. 5445359→6194400	L06,L07 BO	0 265 216 436 ¹¹
		12.01-03.02	80	Fg.Nr. 6194401→	BO	0 265 216 709 ¹¹
	2.5 TD EGR 4x4	08.97-03.98	85	Fg.Nr. 5445359→6194400	L06,L07 BO	0 265 216 436 ¹¹
	2.5 TD 4x4					
	2.8 JTD EGR 4x4, JTD 4x4	10.97-11.01	90/94	Fg.Nr. 5445359→6194400	L06,L07 BO	0 265 216 436 ¹¹
2.8 TD EGR 4x4, TD 4x4	12.01-03.02	90/94	Fg.Nr. 6194401→	BO	0 265 216 709 ¹¹	

	2.0 i.e. Bipower CNG 4x4	08.97-11.01	80/85/90/	Fg.Nr. 5445359→6194400	L06,L07 BO	1 273 004 168 ¹⁶
	2.5 TD EGR 4x4, TD 4x4		94			
	2.8 JTD EGR 4x4, JTD 4x4					
	2.8 TD EGR 4x4, TD 4x4					





◀ FIAT Ducato 10 [234..]

	2.0 i.e. Bipower CNG 4x4	03.94-03.02	80	Fg.Nr. 5946343→	BSY	0 265 006 673 ³	
		08.97-11.01	80	Fg.Nr. 5445359→	LAB BO	0 265 006 405 ⁴	
					RAB BO	0 265 006 406 ⁴	
		08.97-03.02	80	Fg.Nr. 5445359→5946342	BO	0 265 006 427 ³	
		12.01-03.02	80		LAB	0 265 006 688 ⁴	
					RAB	0 265 006 689 ⁴	
	2.5 TD EGR 4x4	08.97-03.98	85	Fg.Nr. 5445359→	LAB BO	0 265 006 405 ⁴	
	2.5 TD 4x4				RAB BO	0 265 006 406 ⁴	
				Fg.Nr. 5445359→5946342	BO	0 265 006 427 ³	
	2.8 JTD EGR 4x4	10.97-11.01	90/94	Fg.Nr. 5445359→	LAB BO	0 265 006 405 ⁴	
	2.8 JTD 4x4				RAB BO	0 265 006 406 ⁴	
	2.8 TD EGR 4x4	10.97-03.02	90/94	Fg.Nr. 5445359→5946342	BO	0 265 006 427 ³	
	2.8 TD 4x4			Fg.Nr. 5946343→	BSY	0 265 006 673 ³	
		12.01-03.02	90/94		LAB	0 265 006 688 ⁴	
					RAB	0 265 006 689 ⁴	

Ducato 10 [279..]



	1.9 D, TD	07.90-02.94	52/55/60/		OE,ZE	1 987 476 462	435
	2.0		63/70		UE,ZE	1 987 476 463	435
	2.5 TD						

	1.9 D, TD	07.90-02.94	52/55/60/		MH	0 986 473 776	 ← 38
	2.0		63/70			0 986 473 777	 → 38
	2.5 TD						



	1.9 D, TD	07.90-02.94	52/55/60/		FCC	1 987 476 244 ¹	265
	2.0		63				
	2.5 TD	07.90-02.94	70			1 987 476 688 ¹	290
					FCC	1 987 476 244 ¹	265

	1.9 D, TD	07.90-02.94	52/55/60/			0 986 475 420	↔ 25,4
	2.0		63/70				
	2.5 TD						



	1.9 D	07.90-02.94	52/60		RLE	F 026 003 150	22,19
	1.9 TD			Fg.Nr. →0273004, →0169505	LLE BSY	F 026 003 150	22,19
				Fg.Nr. 0273005→, 0169506→	LLE BSY	F 026 003 194	22,19
	2.0	07.90-02.94	55	Fg.Nr. →0273004, →0169505	LLE BSY	F 026 003 150	22,19
				Fg.Nr. 0273005→, 0169506→	LLE BSY	F 026 003 194	22,19
	2.0	07.90-02.94	63/70		RLE	F 026 003 150	22,19
	2.5 TD			Fg.Nr. →0273004, →0169505	LLE BSY	F 026 003 150	22,19
				Fg.Nr. 0273005→, 0169506→	LLE BSY	F 026 003 194	22,19



	1.9D	07.90-02.94	52/55/60/	RLE	BSY	0 204 125 416 ²⁵	
	1.9TD		63/70			0 204 125 417	
	2.0			Fg.Nr. →0169505	LLE	BSY	0 204 125 417
	2.5TD			Fg.Nr. 0169506→	LLE	BSY	0 204 125 423
				Fg.Nr. →0273004, →0169505	LLE	BSY	0 204 125 416 ²⁵
			Fg.Nr. 0273005→, 0169506→	LLE	BSY	0 204 125 420 ²⁵	

	2.0	07.90-02.94	55			1 987 477 515	2566
					LLE	1 987 477 417	1608
					RLE	1 987 477 420	1642
				63	LLE	1 987 477 417	1608
					RLE	1 987 477 420	1642

Ducato 10 [280..]



	1.8	06.85-06.90	49-51/52/	OE,ZE		1 987 476 462	435	
	1.9D, TD		60	UE,ZE		1 987 476 463	435	
	2.0	06.85-12.85	55				1 987 476 548	385
		06.88-06.90	54-55/63	OE,ZE			1 987 476 462	435
	2.5D	01.86-06.90	54-55/63	UE,ZE			1 987 476 463	435
				OE,ZE			1 987 476 462	435
			UE,ZE			1 987 476 463	435	

	1.8	06.85-06.90	49-51			0 986 473 776	↻ ← 38			
						0 986 473 777	↻ → 38			
	1.9D	02.87-06.90	52		MIH		0 986 473 776	↻ ← 38		
							0 986 473 777	↻ → 38		
	1.9TD	02.87-06.90	60				0 986 473 776	↻ ← 38		
							0 986 473 777	↻ → 38		
	2.0	06.85-12.85	55	Ricam.Nr VETT.0154463→			0 986 473 776	↻ ← 38		
							0 986 473 777	↻ → 38		
						06.88-06.90	63		0 986 473 776	↻ ← 38
									0 986 473 777	↻ → 38
	2.5D	01.86-06.90	54-55		MIH		0 986 473 776	↻ ← 38		
							0 986 473 777	↻ → 38		



	1.8	06.85-06.90	49-51/52/	FKR		1 987 476 244 ¹	265
	1.9D, TD		54-55/60/	FMR		1 987 476 688 ¹	290
	2.0		63				
	2.5D						

	1.8	06.85-06.90	49-51/52/			0 986 475 420	↔ 25,4	
	1.9D, TD		60					
	2.0	06.85-12.85	55	Ricam.Nr VETT.77161→ Ricam.Nr →VET77160			0 986 475 420	↔ 25,4
							F 026 002 453	↔ 22,19
		06.88-06.90	54-55/63				0 986 475 420	↔ 25,4
2.5D	01.86-06.90	54-55/63				0 986 475 420	↔ 25,4	



	1.8	01.86-06.90	49-51/52/		BSY	F 026 003 150	22,19	
	1.9D, TD		60					
	2.0	06.85-12.85	55				F 026 003 150	22,19
						BSY	F 026 003 150	22,19
	2.5D	01.86-06.90	54-55/63			BSY	F 026 003 150	22,19





◀ FIAT Ducato 10 [280..]

	1.8	06.85-06.90	49-51/52/		0 204 125 417	
	1.9D, TD		54-55/60/			
	2.0		63			
	2.5D					

	1.8	06.85-06.90	49-51/55/		1 987 477 515	2566
	2.0		63			

Ducato 11 [243..]

















	2.0 i.e.	ABO	04.02-08.06	81	UE	1 987 481 004	470
			02.04-08.06	81	OE	1 987 481 067	500
			ABS 04.02-08.06	81		1 987 481 067	500
	2.0 JTD	ABO	04.02-08.06	62	UE	1 987 481 004	470
			02.04-08.06	62	OE	1 987 481 067	500
			ABS 04.02-08.06	62		1 987 481 067	500
	2.3 JTD	ABO	04.02-08.06	81	UE	1 987 481 004	470
			02.04-08.06	81	OE	1 987 481 067	500
			01.08→	81	OE	1 987 481 067	500
					UE	1 987 481 004	470
			ABS 04.02-08.06	81		1 987 481 067	500
	2.3 JTD EGR	ABO	04.02-08.06	81	UE	1 987 481 004	470
02.04-08.06			81	OE	1 987 481 067	500	
2.8 JTD, JTD EGR	ABO	04.02-08.06	81/90/94	UE	1 987 481 067	500	
		02.04-08.06	81/90/94	OE	1 987 481 067	500	
2.8 TD, TD EGR	ABS	04.02-08.06	81/90/94		1 987 481 067	500	



	2.0 i.e.	ABO	04.02-08.06	62/81		1 987 481 002 ¹	360
			2.0 JTD	ABS 04.02-08.06	62/81	LAB	1 987 481 018 ¹
	2.3 JTD	ABO	04.02-08.06	81		1 987 481 019 ¹	385
			01.08→	81		1 987 481 002 ¹	360
			ABS 04.02-08.06	81	LAB	1 987 481 018 ¹	385
		01.08→	81		RAB	1 987 481 019 ¹	385
					LAB	1 987 481 018 ¹	385
					RAB	1 987 481 019 ¹	385
	2.3 JTD EGR	ABO	04.02-08.06	81		1 987 481 002 ¹	360
			ABS 04.02-08.06	81	LAB	1 987 481 018 ¹	385
	2.8 JTD, JTD EGR	ABO	04.02-08.06	81/90/94	RAB	1 987 481 019 ¹	385
2.8 TD, TD EGR	ABS	04.02-08.06	81/90/94	LAB	1 987 481 002 ¹	360	
				RAB	1 987 481 018 ¹	385	
				RAB	1 987 481 019 ¹	385	

	2.0 i.e.	04.02-08.06	81	APD	0 986 475 906	↔ 26,99
	2.0 JTD	04.02-08.06	62	APD	0 986 475 906	↔ 26,99
	2.3 JTD	04.02-08.06	81	APD	0 986 475 906	↔ 26,99
			01.08→	81	APD	0 986 475 906
	2.3 JTD EGR	04.02-08.06	81/90/94	APD	0 986 475 906	↔ 26,99
	2.8 JTD, JTD EGR					
2.8 TD, TD EGR						

									
									
	2.0 i.e.	ABO	04.02-08.06	81			0 204 123 616	25,4	
		ABS	04.02-08.06	81			0 204 123 615	25,4	
	2.0 JTD	ABO	04.02-08.06	62			0 204 123 616	25,4	
		ABS	04.02-08.06	62			0 204 123 615	25,4	
	2.3 JTD	ABO	04.02-08.06	81			0 204 123 616	25,4	
			01.08→	81			0 204 123 616	25,4	
		ABS	04.02-08.06	81			0 204 123 615	25,4	
	2.3 JTD EGR	ABO	04.02-08.06	81			0 204 123 616	25,4	
		ABS	04.02-08.06	81			0 204 123 615	25,4	
	2.8 JTD	ABO	04.02-08.06	94			0 204 123 616	25,4	
	2.8 JTD EGR	ABO	04.02-08.06	94		AG	0 204 123 615	25,4	
						GS	0 204 123 616	25,4	
	2.8 JTD, JTD EGR	ABS	04.02-08.06	94			0 204 123 615	25,4	
	2.8 TD	ABO	10.02-08.06	90			0 204 123 616	25,4	
	2.8 TD EGR	ABS	10.02-08.06	90			0 204 123 615	25,4	
	2.0 i.e.		04.02-08.06	81			0 204 125 801		
		ABO	04.02-08.06	81			0 204 024 593 ²⁵		
		ABS	04.02-08.06	81			0 204 024 592 ²⁵		
	2.0 JTD		04.02-08.06	62			0 204 125 801		
		ABO	04.02-08.06	62			0 204 024 593 ²⁵		
		ABS	04.02-08.06	62			0 204 024 592 ²⁵		
	2.3 JTD		04.02-08.06	81			0 204 125 801		
			01.08→	81			0 204 125 801		
	2.3 JTD EGR		04.02-08.06	81			0 204 125 801		
	2.3 JTD	ABO	04.02-08.06	81			0 204 024 593 ²⁵		
	2.3 JTD EGR	ABS	04.02-08.06	81			0 204 024 592 ²⁵		
	2.8 JTD		04.02-08.06	94			0 204 125 801		
		ABO	04.02-08.06	94			0 204 024 593 ²⁵		
		ABS	04.02-08.06	94			0 204 024 592 ²⁵		
	2.8 JTD EGR		04.02-08.06	94		BUS,FKR	0 204 125 849		
						BUS,KLR	0 204 125 801		
		ABO	04.02-08.06	94		GS	0 204 024 593 ²⁵		
		ABS	04.02-08.06	94		GS	0 204 024 592 ²⁵		
2.8 TD		10.02-08.06	90			0 204 125 801			
2.8 TD EGR	ABO	10.02-08.06	90			0 204 024 593 ²⁵			
	ABS	10.02-08.06	90			0 204 024 592 ²⁵			
	2.0 i.e., JTD	ABO	04.02-08.06	62/81			0 204 031 182 ¹⁰		
	2.3 JTD		01.08→	81			0 204 031 182 ¹⁰		
		ABO	04.02-08.06	81			0 204 031 182 ¹⁰		
	2.3 JTD EGR	ABO	04.02-08.06	81			0 204 031 182 ¹⁰		
	2.8 JTD, JTD EGR	ABO	04.02-08.06	90/94			0 204 031 182 ¹⁰		
2.8 TD, TD EGR									
	2.0 i.e.		04.02-08.06	81	SBR	1 987 482 003	2715		
					TBR	1 987 477 263	2827		
	2.0 JTD		04.02-08.06	62	SBR	1 987 482 003	2715		
					TBR	1 987 477 263	2827		
	2.3 JTD		04.02-08.06	81	SBR	1 987 482 003	2715		
					TBR	1 987 477 263	2827		
			01.08→	81	TBR	1 987 477 263	2827		
	2.3 JTD EGR		04.02-08.06	81	SBR	1 987 482 003	2715		
				81/90/94	TBR	1 987 477 263	2827		
	2.8 JTD, JTD EGR		04.02-08.06	81/90/94	SBR	1 987 482 003	2715		
2.8 TD, TD EGR				TBR	1 987 477 263	2827			





◀ FIAT Ducato 11 [243..]

	2.0 i.e.	04.02-08.06	81		0 265 216 709 ¹¹	
	2.0 JTD	04.02-08.06	62		0 265 216 709 ¹¹	
	2.3 JTD	04.02-08.06	81		0 265 216 709 ¹¹	
		01.08→	81		0 265 216 709 ¹¹	
	2.3 JTD EGR	04.02-08.06	81/90/94		0 265 216 709 ¹¹	
2.8 JTD, JTD EGR						
2.8 TD, TD EGR						

	2.0 i.e., JTD	04.02-08.06	62/81/90/		0 265 006 673 ³	
	2.3 JTD, JTD EGR		94	LAB	0 265 006 688 ⁴	
	2.8 JTD, JTD EGR			RAB	0 265 006 689 ⁴	
	2.8 TD, TD EGR					

Ducato 11 [247..]



	2.0 i.e. 4x4	ABO	04.02-08.06	81	UE	1 987 481 004	470
			02.04-08.06	81	OE	1 987 481 067	500
	2.8 JTD EGR 4x4	ABS	04.02-08.06	81		1 987 481 067	500
		ABO	04.02-08.06	94	UE	1 987 481 004	470
			02.04-08.06	94	OE	1 987 481 067	500
	2.8 JTD 4x4	ABS	04.02-08.06	94		1 987 481 067	500
		ABO	04.02-08.06	94	UE	1 987 481 004	470
	2.8 TD EGR 4x4	ABO	10.02-08.06	90	UE	1 987 481 004	470
			02.04-08.06	90	OE	1 987 481 067	500
		ABS	10.02-08.06	90		1 987 481 067	500



	2.0 i.e. 4x4	ABO	04.02-08.06	81		1 987 481 002 ¹	360
		ABS	04.02-08.06	81	LAB	1 987 481 018 ¹	385
	2.8 JTD EGR 4x4				RAB	1 987 481 019 ¹	385
		ABO	04.02-08.06	94		1 987 481 002 ¹	360
		2.8 JTD 4x4	ABS	04.02-08.06	94	LAB	1 987 481 018 ¹
	2.8 JTD 4x4				RAB	1 987 481 019 ¹	385
		2.8 JTD 4x4		04.02-08.06	94		1 987 476 006 ¹
	2.8 TD EGR 4x4					1 987 476 629 ²	160
		ABO	10.02-08.06	90		1 987 481 002 ¹	360
		ABS	10.02-08.06	90	LAB	1 987 481 018 ¹	385
				RAB	1 987 481 019 ¹	385	



	2.0 i.e. 4x4	ABO	04.02-08.06	81		0 204 123 616	25,4
		ABS	04.02-08.06	81		0 204 123 615	25,4
	2.8 JTD EGR 4x4	ABO	04.02-08.06	94	AG	0 204 123 615	25,4
					GS	0 204 123 616	25,4
	2.8 JTD EGR 4x4, JTD 4x4	ABS	04.02-08.06	94		0 204 123 615	25,4
	2.8 JTD 4x4	ABO	04.02-08.06	94		0 204 123 616	25,4
	2.8 TD EGR 4x4	ABO	10.02-08.06	90		0 204 123 616	25,4
		ABS	10.02-08.06	90		0 204 123 615	25,4

	2.0 i.e. 4x4		04.02-08.06	81		0 204 125 801	
		ABO	04.02-08.06	81		0 204 024 593 ²⁵	
		ABS	04.02-08.06	81		0 204 024 592 ²⁵	
	2.8 JTD EGR 4x4		04.02-08.06	94		0 204 125 801	
	2.8 JTD 4x4	ABO	04.02-08.06	94	GS	0 204 024 593 ²⁵	
		ABS	04.02-08.06	94	GS	0 204 024 592 ²⁵	
	2.8 TD EGR 4x4		10.02-08.06	90		0 204 125 801	
		ABO	10.02-08.06	90		0 204 024 593 ²⁵	
		ABS	10.02-08.06	90		0 204 024 592 ²⁵	



	2.0 i.e. 4x4	ABO	04.02-08.06	81	KOB, KW	0 204 131 232 ¹⁰	
		ABS	04.02-08.06	81		0 204 031 050 ¹⁰	
	2.8 JTD EGR 4x4	ABO	04.02-08.06	94	KOB, KW	0 204 131 232 ¹⁰	
					LAB, WIF	0 204 031 056 ¹⁰	
					RAB, WIF	0 204 131 232 ¹⁰	
	2.8 JTD EGR 4x4, JTD 4x4	ABS	04.02-08.06	94		0 204 031 050 ¹⁰	
	2.8 JTD 4x4		04.02-08.06	94		0 204 131 232 ¹⁰	
		ABO	04.02-08.06	94	LAB, WIF	0 204 031 056 ¹⁰	
	2.8 TD EGR 4x4	ABO	10.02-08.06	90	KOB, KW	0 204 131 232 ¹⁰	
					LAB, WIF	0 204 031 056 ¹⁰	
			ABS	10.02-08.06	90	RAB, WIF	0 204 131 232 ¹⁰

	2.0 i.e. 4x4		04.02-08.06	81		1 987 482 003	2715
	2.8 JTD EGR 4x4		04.02-08.06	94		1 987 482 003	2715
	2.8 JTD 4x4		04.02-08.06	94	SBR	1 987 482 003	2715
	2.8 TD EGR 4x4		10.02-08.06	90		1 987 482 003	2715

	2.0 i.e. 4x4		04.02-08.06	81/90/94		0 265 216 707 ¹¹	
	2.8 JTD EGR 4x4, JTD 4x4						
	2.8 TD EGR 4x4						

	2.0 i.e. 4x4		04.02-08.06	81		0 265 006 673 ³	
	2.8 JTD EGR 4x4		04.02-08.06	94		0 265 006 673 ³	
	2.8 JTD 4x4		04.02-08.06	94		0 265 006 673 ³	
					LAB	0 265 006 688 ⁴	
					RAB	0 265 006 689 ⁴	
	2.8 TD EGR 4x4		10.02-08.06	90		0 265 006 673 ³	

Ducato 11 [250..]



	2.2 JTD		06.06→	74/88/96/		0 204 902 000	← 48
	2.3 JTD			116		0 204 902 001	→ 48
	3.0 JTD						



	2.2 JTD	ESP	06.06→	74	GS	0 204 123 719	25,4
					HAG	0 204 123 723	25,4
		OFD	06.06→	74	GS	0 204 123 718	25,4
					HAG	0 204 123 722	25,4
	2.3 JTD	ESP	06.06→	88/96	GS	0 204 123 719	25,4
					HAG	0 204 123 723	25,4
		OFD	06.06→	88/96	GS	0 204 123 718	25,4
					HAG	0 204 123 722	25,4
	3.0 JTD	ESP	06.06→	116	GS	0 204 123 719	25,4
					HAG	0 204 123 723	25,4
		OFD	06.06→	116	GS	0 204 123 718	25,4
					HAG	0 204 123 722	25,4

	2.2 JTD		06.06→	74/88/96/	BSS	0 204 125 858	
	2.3 JTD			116	BSS	0 204 125 859	
	3.0 JTD						

	2.2 JTD		06.06→	74/88/96/	FKR, FMR	1 987 482 213	↔ 1593
	2.3 JTD			116	FLR	1 987 482 214	↔ 335
	3.0 JTD						





◀ FIAT Ducato 11 [250..]

	2.2 JTD	06.06-01.08	74/88/96/		0 265 231 618 ¹¹	
	2.3 JTD		116		0 265 233 330 ¹⁴	
	3.0 JTD	06.06→	74/88/96/116	GS	0 265 234 069 ²⁶	
	2.2 JTD	06.06→	74/88/96/		0 265 007 685 ³	
	2.3 JTD		116	FLR	0 265 007 833 ⁴	
	3.0 JTD					

Ducato 12 [284..]



	2.0 4x4	07.90-02.94	55/63/70	OE,ZE	1 987 476 462	435
	2.5 D 4x4			UE,ZE	1 987 476 463	435
	2.5 TD 4x4					

	2.0 4x4	07.90-02.94	63	MHH	0 986 473 776	← 38
					0 986 473 777	→ 38
	2.5 D 4x4	07.90-02.94	55		0 986 473 776	← 38
					0 986 473 777	→ 38



	2.0 4x4	07.90-02.94	55/63/70		1 987 476 688 ¹	290
	2.5 D 4x4					
	2.5 TD 4x4					

	2.0 4x4	07.90-02.94	63		0 986 475 420	↔ 25,4
--	---------	-------------	----	--	----------------------	--------



	2.0 4x4	07.90-02.94	63	RLE	F 026 003 150	22,19
				LLE	BSY F 026 003 150	22,19
				LLE	BSY F 026 003 194	22,19
				LLE	BSY F 026 003 150	22,19
	2.5 D 4x4	07.90-02.94	55		F 026 003 150	22,19

	2.0 4x4	07.90-02.94	55/63	RLE	BSY 0 204 125 416 ²⁵	
	2.5 D 4x4			LLE	BSY 0 204 125 417	
				LLE	BSY 0 204 125 423	
				LLE	BSY 0 204 125 416 ²⁵	
				LLE	BSY 0 204 125 420 ²⁵	
				LLE	BSY 0 204 125 550 ²⁵	
				RLE	BSY 0 204 125 416 ²⁵	

	2.0 4x4	07.90-02.94	63	LLE	1 987 477 417	1608
				RLE	1 987 477 420	1642

Ducato 13 [280..]



	2.0	06.85-12.85	55	Ricam.Nr VETT.0154463→	0 986 473 776	← 38
					0 986 473 777	→ 38



	2.0	06.85-12.85	55	Ricam.Nr VETT.77161→	0 986 475 420	↔ 25,4
				Ricam.Nr →VET77160	F 026 002 453	↔ 22,19



	2.0	06.85-12.85	55		F 026 003 150	22,19
--	-----	-------------	----	--	---------------	-------

	2.0	06.85-12.85	55		0 204 125 417	
--	-----	-------------	----	--	---------------	--

	2.0	06.85-12.85	55		1 987 477 515	2566
--	-----	-------------	----	--	---------------	------

Ducato 14 [231..]



	1.9 TD	ABO 03.94-10.01	60/66	OE	1 987 476 329	485
				UE	1 987 481 063	490
		ABS 03.94-10.01	60/66		1 987 476 329	485
	1.9 TD CAT	ABO 03.94-03.98	59/62/63/64/79/80/ 85/90	OE	1 987 476 329	485
				UE	1 987 481 063	490
		ABS 03.94-03.98	59/62/63/64/79/80/85/90		1 987 476 329	485
	2.0	ABO 03.94-03.02	59/62/63/64/79/80/ 85/90	OE	1 987 476 329	485
	2.0 i.e.			UE	1 987 481 063	490
	2.0 JTD	ABS 03.94-03.02	59/62/63/64/79/80/85/90		1 987 476 329	485
	2.5 D, TD	ABO 03.94-03.98	59/62/63/64/79/80/ 85/90	OE	1 987 476 329	485
	2.5 TD ECO			UE	1 987 481 063	490
	2.5 TD EGR	ABS 03.94-03.98	59/62/63/64/79/80/85/90		1 987 476 329	485
	2.8 D	ABO 10.97-03.02	59/62/63/64/79/80/ 85/90	OE	1 987 476 329	485
	2.8 TD			UE	1 987 481 063	490
	2.8 TD EGR	ABS 10.97-03.02	59/62/63/64/79/80/85/90		1 987 476 329	485

	1.9 TD, TD CAT	ABO 03.94-03.02	59/60/62/63/66/79/80		0 986 473 161	↻ ← 40,39
	2.0, i.e., JTD				0 986 474 161	↻ → 40,39
	2.5 D					
	2.5 TD, TD ECO	ABO 03.94-03.98	80/85		0 986 473 162	↻ ← 40,39
	2.5 TD EGR				0 986 474 162	↻ → 40,39
	2.8 D	ABO 04.98-03.02	64		0 986 473 161	↻ ← 40,39
					0 986 474 161	↻ → 40,39
	2.8 TD	ABO 10.97-03.02	90		0 986 473 162	↻ ← 40,39
	2.8 TD EGR				0 986 474 162	↻ → 40,39



	1.9 TD	ABO 03.94-10.01	60/66	FEN	1 987 481 017 ¹	360		
				ABS 03.94-10.01	60/66	FEN,LAB	1 987 476 689 ¹	335
						LVF	1 987 481 018 ¹	385
						RNF	1 987 481 061	360
							1 987 481 061 ¹	360
							RVF	1 987 481 019 ¹





FIAT Ducato 14 [231..]

1.9 TD CAT	ABO	03.94-03.98	59/79/80	FEN	1987 481 017 ¹	360
	ABS	03.94-03.98	59/79/80	FEN,LAB	1987 476 689 ¹	335
				LVF	1987 481 018 ¹	385
				RNF	1987 481 061 ¹	360
					1987 481 061 ¹	360
				RVF	1987 481 019 ¹	385
2.0	ABO	03.94-03.02	59/79/80	FEN	1987 481 017 ¹	360
	ABS	03.94-03.02	59/79/80	FEN,LAB	1987 476 689 ¹	335
2.0 i.e.				LVF	1987 481 018 ¹	385
				RNF	1987 481 061 ¹	360
					1987 481 061 ¹	360
				RVF	1987 481 019 ¹	385
2.0 JTD	ABO	10.01-03.02	63	FEN	1987 481 017 ¹	360
2.5 D	ABO	03.94-03.98	62/64/80/ 85/90	FEN	1987 481 017 ¹	360
2.5 TD	ABS	03.94-03.98	62/64/80/ 85/90	FEN,LAB	1987 476 689 ¹	335
				LVF	1987 481 018 ¹	385
				RNF	1987 481 061 ¹	360
					1987 481 061 ¹	360
				RVF	1987 481 019 ¹	385
2.5 TD ECO						
2.5 TD EGR						
2.8 D	ABS	10.97-03.02	62/64/80/ 85/90	FEN,LAB	1987 476 689 ¹	335
				LVF	1987 481 018 ¹	385
				RNF	1987 481 061 ¹	360
					1987 481 061 ¹	360
				RVF	1987 481 019 ¹	385
2.8 D, TD, TDEGR	ABO	10.97-03.02	62/64/80/85/90	FEN	1987 481 017 ¹	360
2.8 TD EGR	ABS	10.97-03.02	62/64/80/ 85/90	FEN,LAB	1987 476 689 ¹	335
				RNF	1987 481 061 ¹	360
					1987 481 061 ¹	360

1.9 TD, TD CAT		03.94-03.02	59/60/62/ 66/79/80		0986 475 802	↔ 27
	2.0, i.e.					
2.5 D						
2.5 TD, TD ECO		03.94-03.98	80/85	KOB	0986 475 801	↔ 25,4
	2.5 TD EGR			KW	0986 475 802	↔ 27
2.8 D		04.98-03.02	64		0986 475 802	↔ 27
2.8 JTD, JTD EGR		10.97-03.02	90/94		0986 475 801	↔ 25,4
2.8 TD, TD EGR						



1.9 TD	ABO	03.94-03.98	60	Fg.Nr. →5064996	LLE	F 026 003 318	22,19	
					RLE	0 204 123 319	22,19	
				Fg.Nr. 5064997→	RLE	0 204 122 270	23,8	
		04.98-10.01	66	Fg.Nr. 5687088→	RLE	0 204 123 325	23,8	
				Fg.Nr. 5984272→	LLE	F 026 003 313	25,4	
		ABS	03.94-03.98	60	Fg.Nr. →5064996	0 204 123 320	22,19	
				Fg.Nr. 5064997→	F 026 003 315	25,4		
			04.98-10.01	66		F 026 003 315	25,4	
	1.9 TD CAT	ABO	03.94-03.98	59	Fg.Nr. →5064996	LLE	F 026 003 318	22,19
						RLE	0 204 123 319	22,19
					Fg.Nr. 5064997→	RLE	0 204 122 270	23,8
			ABS	03.94-03.98	59	Fg.Nr. →5064996	0 204 123 320	22,19
				Fg.Nr. 5064997→	F 026 003 315	25,4		

		S							
2.0	ABO	03.94-08.00	79/80	Fg.Nr. 5687088→5984271	RLE		0 204 123 325	23,8	
2.0 i.e.		03.94-03.02	79/80	Fg.Nr. →5064996	LLE		F 026 003 318	22,19	
					RLE		0 204 123 319	22,19	
				Fg.Nr. 5064997→5687087	RLE		0 204 122 270	23,8	
				Fg.Nr. 5984272→6194400	LLE		F 026 003 313	25,4	
				Fg.Nr. 6194401→			0 204 123 616	25,4	
	ABS	03.94-03.02	79/80	Fg.Nr. →5064996			0 204 123 320	22,19	
				Fg.Nr. 5064997→6194400			F 026 003 315	25,4	
				Fg.Nr. 6194401→			0 204 123 615	25,4	
2.0 JTD	ABO	10.01-03.02	63	Fg.Nr. →6194400	LLE		F 026 003 313	25,4	
				Fg.Nr. 6194401→			0 204 123 616	25,4	
	ABS	10.01-03.02	63	Fg.Nr. →6194400			F 026 003 315	25,4	
				Fg.Nr. 6194401→			0 204 123 615	25,4	
2.5 D	ABO	03.94-03.98	62/80/85	Fg.Nr. →5064996	LLE		F 026 003 318	22,19	
2.5 TD					RLE		0 204 123 319	22,19	
2.5 TD ECO				Fg.Nr. 5064997→	RLE		0 204 122 270	23,8	
2.5 TD EGR	ABS	03.94-03.98	62/80/85	Fg.Nr. →5064996			0 204 123 320	22,19	
				Fg.Nr. 5064997→			F 026 003 315	25,4	
2.8 D	ABO	04.98-08.00	64	Fg.Nr. 5687088→5984271	RLE		0 204 123 325	23,8	
		04.98-03.02	64	Fg.Nr. 5064997→5687087	RLE		0 204 122 270	23,8	
				Fg.Nr. 5984272→6194400	LLE		F 026 003 313	25,4	
				Fg.Nr. 6194401→			0 204 123 616	25,4	
	ABS	04.98-03.02	64	Fg.Nr. →6194400			F 026 003 315	25,4	
				Fg.Nr. 6194401→			0 204 123 615	25,4	
2.8 JTD	ABO	08.00-03.02	94	Fg.Nr. 6194401→			0 204 123 616	25,4	
2.8 JTD EGR		09.00-11.01	94	Fg.Nr. 5984272→6194400	LLE		F 026 003 313	25,4	
	ABS	08.00-03.02	94	Fg.Nr. 6194401→			0 204 123 615	25,4	
		09.00-11.01	94	Fg.Nr. 5984272→6194400	LLE		F 026 003 315	25,4	
2.8 TD	ABO	10.97-08.00	90	Fg.Nr. 5687088→5984271	RLE		0 204 123 325	23,8	
2.8 TD EGR		10.97-03.02	90	Fg.Nr. 5064997→5687087	RLE		0 204 122 270	23,8	
				Fg.Nr. 5984272→6194400	LLE		F 026 003 313	25,4	
				Fg.Nr. 6194401→			F 026 003 313	25,4	
	ABS	10.97-03.02	90				F 026 003 315	25,4	
1.9 TD		03.94-03.98	60	Fg.Nr. →5064996			0 204 125 445		
		04.98-08.00	66	Fg.Nr. 5687088→5984271			0 204 125 746		
	ABO	09.00-10.01	66	Fg.Nr. 5984272→	LLE		0 204 125 772		
					RLE		0 204 125 773		
	ABS	09.00-10.01	66	Fg.Nr. 5984272→			0 204 125 772		
1.9 TD CAT		03.94-03.98	59	Fg.Nr. →5064996			0 204 125 445		
2.0		03.94-08.00	79/80	Fg.Nr. 5687088→5984271			0 204 125 746		
2.0 i.e.		03.94-03.02	79/80	Fg.Nr. →5064996			0 204 125 445		
				Fg.Nr. 5984272→6194400			0 204 125 772		
				Fg.Nr. 6194401→			0 204 125 801		
	ABO	12.01-03.02	79/80	Fg.Nr. 6194401→			0 204 024 593 ²⁵		
	ABS	03.94-03.02	79/80	Fg.Nr. 6194401→			0 204 024 592 ²⁵		
2.0 JTD		10.01-03.02	63	Fg.Nr. →6194400			0 204 125 772		
				Fg.Nr. 6194401→			0 204 125 801		
	ABO	12.01-03.02	63	Fg.Nr. 6194401→			0 204 024 593 ²⁵		
	ABS	10.01-03.02	63	Fg.Nr. 6194401→			0 204 024 592 ²⁵		
2.5 D, TD, TD ECO, TD EGR		03.94-03.98	62/80/85	Fg.Nr. →5064996			0 204 125 445		
2.8 D		04.98-08.00	64	Fg.Nr. 5687088→5984271			0 204 125 746		
		04.98-03.02	64	Fg.Nr. 5984272→6194400			0 204 125 772		
				Fg.Nr. 6194401→			0 204 125 801		
2.8 JTD		08.00-03.02	94	Fg.Nr. →6194400			0 204 125 772		
2.8 JTD EGR				Fg.Nr. 6194401→			0 204 125 801		
	ABO	12.01-03.02	94	Fg.Nr. 6194401→			0 204 024 593 ²⁵		
	ABS	08.00-03.02	94	Fg.Nr. 6194401→			0 204 024 592 ²⁵		
2.8 TD		10.97-08.00	90	Fg.Nr. 5687088→5984271			0 204 125 746		
2.8 TD EGR		10.97-03.02	90	Fg.Nr. 5984272→			0 204 125 772		





◀ FIAT Ducato 14 [231..]

	1.9 TD	ABO	03.94-10.01	60/66		LAB,WIF	0 204 031 056 ¹⁰	
						RAB	0 204 131 232 ¹⁰	
		ABS	03.94-07.97	60	Fg.Nr. →5445358		0 204 031 050 ¹⁰	
			03.94-03.98	60			0 204 131 217	
	1.9 TD CAT	ABO	03.94-03.98	59		LAB,WIF	0 204 031 056 ¹⁰	
						RAB	0 204 131 232 ¹⁰	
		ABS	03.94-07.97	59	Fg.Nr. →5445358		0 204 031 050 ¹⁰	
			03.94-03.98	59			0 204 131 217	
	2.0	ABO	03.94-03.02	79/80			0 204 131 232 ¹⁰	
	2.0 i.e.	ABS	03.94-07.97	79/80	Fg.Nr. →5445358		0 204 031 050 ¹⁰	
	2.0 JTD	ABO	10.01-03.02	63	Fg.Nr. 5048611→		0 204 131 232 ¹⁰	
	2.5 D	ABO	03.94-03.98	62/80/85		LAB,WIF	0 204 031 056 ¹⁰	
						RAB	0 204 131 232 ¹⁰	
	2.5 TD							
	2.5 TD ECO	ABS	03.94-07.97	62/80/85	Fg.Nr. →5445358		0 204 031 050 ¹⁰	
	2.5 TD EGR	ABO	03.94-03.98	85		LAB,WIF	0 204 031 056 ¹⁰	
						RAB	0 204 131 232 ¹⁰	
		ABS	03.94-07.97	85	Fg.Nr. →5445358		0 204 031 050 ¹⁰	
			03.94-03.98	85			0 204 131 217	
	2.8 D, JTD, JTD EGR	ABO	10.97-03.02	64/90/94		LAB,WIF	0 204 031 056 ¹⁰	
	2.8 TD, TD EGR					RAB	0 204 131 232 ¹⁰	

	1.9 TD		03.94-11.01	59/60/66/		LLE	1 987 477 114	1059
				79		RLE	1 987 482 046	1137
	1.9 TD CAT							
	2.0		03.94-03.02	59/60/66/	Fg.Nr. →6158428	FEN	1 987 477 113	3025
					79		FEV	1 987 477 115
	2.0 i.e.		03.94-11.01	80		LLE	1 987 477 114	1059
							RLE	1 987 482 046
					Fg.Nr. 6158429→	FEN	1 987 477 262	2806
						FEV	1 987 482 006	2827
			03.94-03.02	80	Fg.Nr. →6158428	FEN	1 987 477 113	3025
						FEV	1 987 477 115	3040
			12.01-03.02	80		LLE	1 987 482 002	1078
						RLE	1 987 482 004	1170
						SBR	1 987 482 003	2715
						TBR	1 987 477 263	2827
	2.0 JTD		10.01-11.01	63		LLE	1 987 477 114	1059
							RLE	1 987 482 046
			10.01-03.02	63			1 987 477 263	2827
					Fg.Nr. →6158428	FEN	1 987 477 113	3025
						FEV	1 987 477 115	3040
	2.5 D		03.94-03.98	62/80/85		LLE	1 987 477 114	1059
	2.5 TD					RLE	1 987 482 046	1137
	2.5 TD ECO				Fg.Nr. →6158428	FEN	1 987 477 113	3025
	2.5 TD EGR					FEV	1 987 477 115	3040
						Fg.Nr. 6158429→	FEN	1 987 477 262
						FEV	1 987 482 006	2827
	2.8 D		10.97-11.01	64/90/94		LLE	1 987 477 114	1059
	2.8 JTD					RLE	1 987 482 046	1137
	2.8 JTD EGR				Fg.Nr. 6158429→	FEN	1 987 477 262	2806
	2.8 TD					FEV	1 987 482 006	2827
	2.8 TD EGR		10.97-03.02	64/90/94	Fg.Nr. →6158428	FEN	1 987 477 113	3025
							FEV	1 987 477 115
			12.01-03.02	64/90/94		LLE	1 987 482 002	1078
						RLE	1 987 482 004	1170
						SBR	1 987 482 003	2715
						TBR	1 987 477 263	2827

		S								
	1.9 TD, TD CAT	08.97-10.01	59/60/66	Fg.Nr. 5445359→6194400	L06,L07	BO	0 265 216 436 ¹¹			
	2.0, i.e., JTD	08.97-11.01	63/79/80	Fg.Nr. 5445359→6194400	L06,L07	BO	0 265 216 436 ¹¹			
		12.01-03.02	63/79/80	Fg.Nr. 6194401→		BO	0 265 216 709 ¹¹			
	2.5 D, TD, TD ECO, TD EGR	08.97-03.98	62/80/85	Fg.Nr. 5445359→6194400	L06,L07	BO	0 265 216 436 ¹¹			
	2.8 D, JTD, JTD EGR	10.97-11.01	64/90/94	Fg.Nr. 5445359→6194400	L06,L07	BO	0 265 216 436 ¹¹			
2.8 TD, TD EGR	12.01-03.02	64/90/94	Fg.Nr. 6194401→		BO	0 265 216 709 ¹¹				
	1.9 TD, TD CAT	08.97-11.01	59/60/62/	Fg.Nr. 5445359→6194400	L06,L07	BO	1 273 004 168 ¹⁶			
	2.0, i.e., JTD		63/64/66/							
	2.5 D, TD, TD ECO, TD EGR		79/80/85/							
	2.8 D, JTD, JTD EGR		90/94							
	1.9 TD	08.97-03.98	60	Fg.Nr. 5445359→	LAB	BO	0 265 006 405 ⁴			
					RAB	BO	0 265 006 406 ⁴			
					Fg.Nr. 5445359→5946342		BO	0 265 006 427 ³		
	04.98-10.01	66	Fg.Nr. 5445359→	LAB	BO	0 265 006 405 ⁴				
				RAB	BO	0 265 006 406 ⁴				
					Fg.Nr. 5445359→5946342		BO	0 265 006 427 ³		
					Fg.Nr. 5946343→		BSY	0 265 006 673 ³		
	1.9 TD CAT	08.97-03.98	59	Fg.Nr. 5445359→	LAB	BO	0 265 006 405 ⁴			
					RAB	BO	0 265 006 406 ⁴			
					Fg.Nr. 5445359→5946342		BO	0 265 006 427 ³		
	2.0	03.94-03.02	79/80	Fg.Nr. 5946343→		BSY	0 265 006 673 ³			
	2.0 i.e.	08.97-11.01	79/80	Fg.Nr. 5445359→	LAB	BO	0 265 006 405 ⁴			
					RAB	BO	0 265 006 406 ⁴			
		08.97-03.02	79/80	Fg.Nr. 5445359→5946342		BO	0 265 006 427 ³			
		12.01-03.02	79/80					0 265 006 688 ⁴		
	2.0 JTD	10.01-11.01	63	Fg.Nr. 5445359→	LAB	BO	0 265 006 405 ⁴			
					RAB	BO	0 265 006 406 ⁴			
		10.01-03.02	63	Fg.Nr. 5946343→		BSY	0 265 006 673 ³			
		12.01-03.02	63					0 265 006 688 ⁴		
								0 265 006 689 ⁴		
	2.5 D, TD	08.97-03.98	62/80/85	Fg.Nr. 5445359→	LAB	BO	0 265 006 405 ⁴			
	2.5 TD ECO				RAB	BO	0 265 006 406 ⁴			
2.5 TD EGR			Fg.Nr. 5445359→5946342		BO	0 265 006 427 ³				
2.8 D	04.98-11.01	64	Fg.Nr. 5445359→	LAB	BO	0 265 006 405 ⁴				
				RAB	BO	0 265 006 406 ⁴				
	04.98-03.02	64	Fg.Nr. 5445359→5946342		BO	0 265 006 427 ³				
	12.01-03.02	64	Fg.Nr. 5946343→		BSY	0 265 006 673 ³				
				LAB		0 265 006 688 ⁴				
				RAB		0 265 006 689 ⁴				
2.8 JTD	08.00-11.01	94	Fg.Nr. 5445359→	LAB	BO	0 265 006 405 ⁴				
2.8 JTD EGR	08.00-03.02	94	Fg.Nr. 5946343→	RAB	BO	0 265 006 406 ⁴				
					BSY	0 265 006 673 ³				
	12.01-03.02	94		LAB		0 265 006 688 ⁴				
				RAB		0 265 006 689 ⁴				
2.8 TD	10.97-11.01	90	Fg.Nr. 5445359→	LAB	BO	0 265 006 405 ⁴				
2.8 TD EGR	10.97-03.02	90	Fg.Nr. 5445359→5946342	RAB	BO	0 265 006 406 ⁴				
					BO	0 265 006 427 ³				
			Fg.Nr. 5946343→		BSY	0 265 006 673 ³				
	12.01-03.02	90		LAB		0 265 006 688 ⁴				
				RAB		0 265 006 689 ⁴				





Ducato 14 [234..]

	2.0 i.e. Bipower CNG 4x4	ABO 03.94-03.02	80/85/90/94	OE	1987 476 329	485		
				UE	1987 481 063	490		
		ABS 03.94-03.02	80/85/90/94		1987 476 329	485		
	2.5 TD ECO 4x4	ABO 03.94-03.98	80/85/90/94	OE	1987 476 329	485		
				UE	1987 481 063	490		
			ABS 03.94-03.98	80/85/90/94		1987 476 329	485	
2.8 JTD EGR 4x4, JTD 4x4	ABO 10.97-03.02	80/85/90/94	OE	1987 476 329	485			
			UE	1987 481 063	490			
		ABS 10.97-03.02	80/85/90/94		1987 476 329	485		

	2.0 i.e. Bipower CNG 4x4	ABO 03.94-03.02	80		0986 473 161	← 40,39
					0986 474 161	→ 40,39
	2.5 TD ECO 4x4	ABO 03.94-03.98	80		0986 473 162	← 40,39
					0986 474 162	→ 40,39
	2.5 TD EGR 4x4	ABO 03.94-03.02	85/90/94		0986 473 162	← 40,39
	2.8 JTD EGR 4x4, JTD 4x4				0986 474 162	→ 40,39
2.8 TD EGR 4x4, TD 4x4						

	2.5 TD ECO 4x4, TD EGR 4x4	ABS 03.94-03.02	80/85/90/94	FEN,LAB	1987 476 689 ¹	335	
				LVF	1987 481 018 ¹	385	
				RNF	1987 481 061	360	
					1987 481 061 ¹	360	
					RVF	1987 481 019 ¹	385

	2.0 i.e. Bipower CNG 4x4	03.94-03.02	80/85/90/94		0986 475 802	↔ 27	
		2.5 TD ECO 4x4, TD EGR 4x4					
	2.8 JTD EGR 4x4, JTD 4x4						
	2.8 TD EGR 4x4, TD 4x4						

	2.0 i.e. Bipower CNG 4x4	ABO 03.94-08.00	80	Fg.Nr. 5687088→5984271	RLE	0 204 123 325	23,8	
				Fg.Nr. →5064996	LLE	F 026 003 318	22,19	
					RLE	0 204 123 319	22,19	
				Fg.Nr. 5064997→5687087	RLE	0 204 122 270	23,8	
				Fg.Nr. 5984272→6194400	LLE	F 026 003 313	25,4	
				Fg.Nr. 6194401→		0 204 123 616	25,4	
		ABS 03.94-03.02	80	Fg.Nr. →5064996		0 204 123 320	22,19	
				Fg.Nr. 5064997→6194400		F 026 003 315	25,4	
				Fg.Nr. 6194401→		0 204 123 615	25,4	
				Fg.Nr. →5064996	LLE	F 026 003 318	22,19	
					RLE	0 204 123 319	22,19	
				Fg.Nr. 5064997→	RLE	0 204 122 270	23,8	
		2.5 TD ECO 4x4	ABO 03.94-03.98	80	Fg.Nr. →5064996		0 204 123 320	22,19
					Fg.Nr. 5064997→		F 026 003 315	25,4
					Fg.Nr. →5064996	LLE	F 026 003 318	22,19
						RLE	0 204 123 319	22,19
					Fg.Nr. 5064997→	RLE	0 204 122 270	23,8
					Fg.Nr. →5064996		0 204 123 320	22,19
		2.5 TD EGR 4x4	ABO 03.94-03.98	85	Fg.Nr. →5064996		F 026 003 315	25,4
					Fg.Nr. →5064996	LLE	F 026 003 318	22,19
						RLE	0 204 123 319	22,19
					Fg.Nr. 5064997→	RLE	0 204 122 270	23,8
					Fg.Nr. →5064996		0 204 123 320	22,19
					Fg.Nr. 5064997→		F 026 003 315	25,4
2.8 JTD EGR 4x4	ABO 08.00-03.02	94	Fg.Nr. 5984272→6194400	LLE	F 026 003 313	25,4		
			Fg.Nr. 6194401→		0 204 123 616	25,4		
			Fg.Nr. 5984272→6194400		F 026 003 315	25,4		
			Fg.Nr. 6194401→		0 204 123 615	25,4		

		S							
2.8 TD EGR 4x4	ABO	10.97-08.00	90	Fg.Nr. 5687088→5984271	RLE		0 204 123 325	23,8	
2.8 TD 4x4		10.97-03.02	90	Fg.Nr. 5064997→5687087	RLE		0 204 122 270	23,8	
				Fg.Nr. 5984272→6194400	LLE		F 026 003 313	25,4	
				Fg.Nr. 6194401→			F 026 003 313	25,4	
	ABS	10.97-03.02	90				F 026 003 315	25,4	
2.0 i.e. Bipower CNG 4x4		03.94-08.00	80	Fg.Nr. 5687088→5984271			0 204 125 746		
		03.94-03.02	80	Fg.Nr. →5064996			0 204 125 445		
				Fg.Nr. 5984272→6194400			0 204 125 772		
				Fg.Nr. 6194401→			0 204 125 801		
	ABO	12.01-03.02	80	Fg.Nr. 6194401→			0 204 024 593 ²⁵		
	ABS	03.94-03.02	80	Fg.Nr. 6194401→			0 204 024 592 ²⁵		
2.5 TD ECO 4x4		03.94-03.98	80	Fg.Nr. →5064996			0 204 125 445		
2.5 TD EGR 4x4		03.94-03.98	85	Fg.Nr. →5064996			0 204 125 445		
2.8 JTD EGR 4x4		08.00-03.02	94	Fg.Nr. 5984272→6194400			0 204 125 772		
2.8 JTD 4x4				Fg.Nr. 6194401→			0 204 125 801		
	ABO	12.01-03.02	94	Fg.Nr. 6194401→			0 204 024 593 ²⁵		
	ABS	08.00-03.02	94	Fg.Nr. 6194401→			0 204 024 592 ²⁵		
2.8 TD EGR 4x4		10.97-08.00	90	Fg.Nr. 5687088→5984271			0 204 125 746		
2.8 TD 4x4		10.97-03.02	90	Fg.Nr. 5984272→			0 204 125 772		
2.0 i.e. Bipower CNG 4x4	ABS	03.94-07.97	80/85	Fg.Nr. →5445358			0 204 031 050 ¹⁰		
2.5 TD ECO 4x4, TD EGR 4x4									
2.8 JTD EGR 4x4	ABO	08.00-03.02	94		LAB,WIF		0 204 031 056 ¹⁰		
2.8 JTD 4x4					RAB		0 204 131 232 ¹⁰		
2.0 i.e. Bipower CNG 4x4		03.94-11.01	80		FEV	1 987 477 115	3040		
					FMR	1 987 477 113	3025		
					LLE	1 987 477 114	1059		
					RLE	1 987 482 046	1137		
		12.01-03.02	80		LLE	1 987 482 002	1078		
					RLE	1 987 482 004	1170		
					SBR	1 987 482 003	2715		
					TBR	1 987 477 263	2827		
2.5 TD ECO 4x4		03.94-03.98	80		FMR	1 987 477 113	3025		
					LLE	1 987 477 114	1059		
					RLE	1 987 482 046	1137		
				Fg.Nr. →6158428	FEV	1 987 477 115	3040		
2.5 TD EGR 4x4		03.94-03.98	85		FEV	1 987 477 115	3040		
					FMR	1 987 477 113	3025		
					LLE	1 987 477 114	1059		
					RLE	1 987 482 046	1137		
2.8 JTD EGR 4x4		10.97-11.01	90/94		FEV	1 987 477 115	3040		
2.8 JTD 4x4					FMR	1 987 477 113	3025		
2.8 TD EGR 4x4					LLE	1 987 477 114	1059		
2.8 TD 4x4					RLE	1 987 482 046	1137		
		12.01-03.02	90/94		LLE	1 987 482 002	1078		
					RLE	1 987 482 004	1170		
					SBR	1 987 482 003	2715		
					TBR	1 987 477 263	2827		
2.0 i.e. Bipower CNG 4x4		08.97-11.01	80	Fg.Nr. 5445359→6194400	L06,L07 BO	0 265 216 436 ¹¹			
		12.01-03.02	80	Fg.Nr. 6194401→	BO	0 265 216 709 ¹¹			
2.5 TD ECO 4x4		08.97-03.98	80	Fg.Nr. 5445359→6194400	L06,L07 BO	0 265 216 436 ¹¹			
2.5 TD EGR 4x4		08.97-03.98	85	Fg.Nr. 5445359→6194400	L06,L07 BO	0 265 216 436 ¹¹			
2.8 JTD EGR 4x4, JTD 4x4		10.97-11.01	90/94	Fg.Nr. 5445359→6194400	L06,L07 BO	0 265 216 436 ¹¹			
2.8 TD EGR 4x4, TD 4x4		12.01-03.02	90/94	Fg.Nr. 6194401→	BO	0 265 216 709 ¹¹			
2.0 i.e. Bipower CNG 4x4		08.97-11.01	80/85/90/94	Fg.Nr. 5445359→6194400	L06,L07 BO	1 273 004 168 ¹⁶			
2.5 TD ECO 4x4, TD EGR 4x4									
2.8 JTD EGR 4x4, JTD 4x4									
2.8 TD EGR 4x4, TD 4x4									





FIAT Ducato 14 [234..]

	2.0 i.e. Bipower CNG 4x4	03.94-03.02	80	Fg.Nr. 5946343→	BSY	0 265 006 673 ³	
		08.97-11.01	80	Fg.Nr. 5445359→	LAB BO	0 265 006 405 ⁴	
					RAB BO	0 265 006 406 ⁴	
		08.97-03.02	80	Fg.Nr. 5445359→5946342	BO	0 265 006 427 ³	
		12.01-03.02	80		LAB	0 265 006 688 ⁴	
					RAB	0 265 006 689 ⁴	
	2.5 TD ECO 4x4	08.97-03.98	80	Fg.Nr. 5445359→	LAB BO	0 265 006 405 ⁴	
				Fg.Nr. 5445359→5946342	BO	0 265 006 427 ³	
	2.5 TD EGR 4x4	08.97-03.98	85	Fg.Nr. 5445359→	LAB BO	0 265 006 405 ⁴	
					RAB BO	0 265 006 406 ⁴	
				Fg.Nr. 5445359→5946342	BO	0 265 006 427 ³	
	2.8 JTD EGR 4x4	10.97-11.01	90/94	Fg.Nr. 5445359→	LAB BO	0 265 006 405 ⁴	
	2.8 JTD 4x4				RAB BO	0 265 006 406 ⁴	
	2.8 TD EGR 4x4	10.97-03.02	90/94	Fg.Nr. 5445359→5946342	BO	0 265 006 427 ³	
	2.8 TD 4x4			Fg.Nr. 5946343→	BSY	0 265 006 673 ³	
		12.01-03.02	90/94		LAB	0 265 006 688 ⁴	
					RAB	0 265 006 689 ⁴	

Ducato 14 [280..]



	1.9 TD	01.86-02.94	55/60/63/		OE,ZE	1 987 476 462	435
	2.0		68/70		UE,ZE	1 987 476 463	435
	2.5 D, D 4x4, TD, TD 4x4						
	1.9 TD	01.86-06.90	55/60/63			0 986 473 776	← 38
	2.0					0 986 473 777	→ 38
		07.90-02.94	55/60/63		MH	0 986 473 776	← 38
						0 986 473 777	→ 38
	2.5 D	01.86-02.94	55		MH	0 986 473 776	← 38
	2.5 D 4x4					0 986 473 777	→ 38
	2.5 TD	01.86-06.90	68			0 986 473 776	← 38
						0 986 473 777	→ 38
		07.90-02.94	70		MH	0 986 473 776	← 38
						0 986 473 777	→ 38



	1.9 TD	01.86-06.90	55/60/63		FKR	1 987 476 244 ¹	265
	2.0				FMR	1 987 476 688 ¹	290
		07.90-02.94	55/60/63		FCC	1 987 476 244 ¹	265
	2.5 D	01.86-06.90	55		FKR	1 987 476 244 ¹	265
					FMR	1 987 476 688 ¹	290
		07.90-02.94	55		FCC	1 987 476 688 ¹	290
					FCC	1 987 476 244 ¹	265
	2.5 TD	01.86-06.90	68		FKR	1 987 476 244 ¹	265
					FMR	1 987 476 688 ¹	290
		07.90-02.94	70		FCC	1 987 476 688 ¹	290
					FCC	1 987 476 244 ¹	265

	1.9 TD	01.86-02.94	55/60/63/			0 986 475 420	↔ 25,4
	2.0		68/70				
	2.5 D, D 4x4, TD						

		S							
	1.9 TD	01.86-06.90	55/60/63			BSY	F 026 003 150	22,19	
	2.0	07.90-02.94	55/60/63			RLE	F 026 003 150	22,19	
	2.5 D			Fg.Nr. →0273004, →0169505		LLE	BSY	F 026 003 150	22,19
				Fg.Nr. 0273005→, 0169506→		LLE	BSY	F 026 003 194	22,19
	2.5 D 4x4	01.89-06.90	55/60/63			BSY	F 026 003 150	22,19	
	2.5 TD	01.86-06.90	68			BSY	F 026 003 150	22,19	
		07.90-02.94	70			RLE	F 026 003 150	22,19	
				Fg.Nr. →0273004, →0169505		LLE	BSY	F 026 003 150	22,19
				Fg.Nr. 0273005→, 0169506→		LLE	BSY	F 026 003 194	22,19
	1.9 TD	02.87-06.90	60				0 204 125 417		
		07.90-02.94	60			RLE	BSY	0 204 125 416 ²⁵	
							0 204 125 417		
				Fg.Nr. →0169505		LLE	BSY	0 204 125 417	
				Fg.Nr. 0169506→		LLE	BSY	0 204 125 423	
				Fg.Nr. →0273004, →0169505		LLE	BSY	0 204 125 416 ²⁵	
				Fg.Nr. 0273005→, 0169506→		LLE	BSY	0 204 125 420 ²⁵	
	2.0	01.86-06.90	55/63				0 204 125 417		
		07.90-02.94	55/63			RLE	BSY	0 204 125 416 ²⁵	
				Fg.Nr. →0169505		LLE	BSY	0 204 125 417	
				Fg.Nr. 0169506→		LLE	BSY	0 204 125 423	
				Fg.Nr. →0273004, →0169505		LLE	BSY	0 204 125 416 ²⁵	
				Fg.Nr. 0273005→, 0169506→		LLE	BSY	0 204 125 420 ²⁵	
	2.5 D	01.86-06.90	55				0 204 125 417		
		07.90-02.94	55			RLE	BSY	0 204 125 416 ²⁵	
							0 204 125 417		
				Fg.Nr. →0169505		LLE	BSY	0 204 125 417	
				Fg.Nr. 0169506→		LLE	BSY	0 204 125 423	
				Fg.Nr. →0273004, →0169505		LLE	BSY	0 204 125 416 ²⁵	
				Fg.Nr. 0273005→, 0169506→		LLE	BSY	0 204 125 420 ²⁵	
	2.5 D 4x4	01.89-06.90	55				0 204 125 417		
	2.5 TD	01.86-06.90	68				0 204 125 417		
		07.90-02.94	70			RLE	BSY	0 204 125 416 ²⁵	
							0 204 125 417		
				Fg.Nr. →0169505		LLE	BSY	0 204 125 417	
				Fg.Nr. 0169506→		LLE	BSY	0 204 125 423	
				Fg.Nr. →0273004, →0169505		LLE	BSY	0 204 125 416 ²⁵	
				Fg.Nr. 0273005→, 0169506→		LLE	BSY	0 204 125 420 ²⁵	
	2.5 TD 4x4	01.89-06.90	68				0 204 125 345 ²⁵		
	2.0	01.86-02.94	55				1 987 477 515	2566	
		06.88-02.94	63				1 987 477 515	2566	
		07.90-02.94	55			LLE	1 987 477 417	1608	
						RLE	1 987 477 420	1642	
			63			RLE	1 987 477 420	1642	
	2.5 D 4x4	01.89-06.90	55/68			LLE	1 987 477 417	1608	
	2.5 TD 4x4					RLE	1 987 477 420	1642	





Ducato 15 [244..]

















	2.0 i.e.	ABO	04.02-08.06	81	UE	1987 481 004	470
			02.04-08.06	81	OE	1987 481 067	500
		ABS	04.02-08.06	81		1987 481 067	500
	2.0 i.e. Bipower CNG	ABO	04.02-08.06	62/71-81	UE	1987 481 004	470
	2.0 i.e. Bipower LPG		02.04-08.06	62/71-81	OE	1987 481 067	500
	2.0 JTD	ABS	04.02-08.06	62/71-81		1987 481 067	500
	2.3 JTD	ABO	04.02-08.06	81	UE	1987 481 004	470
			02.04-08.06	81	OE	1987 481 067	500
			01.08->	81	OE	1987 481 067	500
					UE	1987 481 004	470
		ABS	04.02-08.06	81		1987 481 067	500
			01.08->	81		1987 481 067	500
	2.3 JTD EGR	ABO	04.02-08.06	81	UE	1987 481 004	470
			02.04-08.06	81	OE	1987 481 067	500
			01.08->	81	OE	1987 481 067	500
					UE	1987 481 004	470
		ABS	04.02-08.06	81		1987 481 067	500
			01.08->	81		1987 481 067	500
	2.8 JTD, JTD CGV, JTD EGR	ABO	04.02-08.06	90/94/107	UE	1987 481 004	470
	2.8 TD, TD EGR		02.04-08.06	90/94/107	OE	1987 481 067	500
		ABS	04.02-08.06	90/94/107		1987 481 067	500



	2.0 i.e.	ABO	04.02-08.06	62/71-81		1987 481 002¹	360	
	2.0 i.e. Bipower CNG	ABS	04.02-08.06	62/71-81	LAB	1987 481 018¹	385	
	2.0 i.e. Bipower LPG				RAB	1987 481 019¹	385	
	2.0 JTD							
	2.3 JTD	ABO	04.02-08.06	81		1987 481 002¹	360	
			01.08->	81		1987 481 002¹	360	
			ABS	04.02-08.06	81	LAB	1987 481 018¹	385
					RAB	1987 481 019¹	385	
			01.08->	81	LAB	1987 481 018¹	385	
					RAB	1987 481 019¹	385	
	2.3 JTD EGR	ABO	04.02-08.06	81		1987 481 002¹	360	
			01.08->	81		1987 481 002¹	360	
			ABS	04.02-08.06	81	LAB	1987 481 018¹	385
						RAB	1987 481 019¹	385
			01.08->	81	LAB	1987 481 018¹	385	
					RAB	1987 481 019¹	385	
	2.8 JTD, JTD CGV, JTD EGR	ABO	04.02-08.06	90/94/107		1987 481 002¹	360	
	2.8 TD, TD EGR	ABS	04.02-08.06	90/94/107	LAB	1987 481 018¹	385	
					RAB	1987 481 019¹	385	

	2.0 i.e.		04.02-08.06	81	APD	0986 475 906	↔ 26,99
	2.0 i.e. Bipower CNG		04.02-08.06	62/71-81	APD	0986 475 906	↔ 26,99
	2.0 i.e. Bipower LPG						
	2.0 JTD						
	2.3 JTD		04.02-08.06	81	APD	0986 475 906	↔ 26,99
			01.08->	81	APD	0986 475 906	↔ 26,99
	2.3 JTD EGR		04.02-08.06	81	APD	0986 475 906	↔ 26,99
			01.08->	81	APD	0986 475 906	↔ 26,99
	2.8 JTD, JTD CGV, JTD EGR		04.02-08.06	90/94/107	APD	0986 475 906	↔ 26,99
	2.8 TD, TD EGR						

									
									
	2.0 i.e.	ABO	04.02-08.06	81			0 204 123 616	25,4	
		ABS	04.02-08.06	81			0 204 123 615	25,4	
	2.0 i.e. Bipower CNG	ABO	04.02-08.06	62/71-81			0 204 123 616	25,4	
	2.0 i.e. Bipower LPG, JTD	ABS	04.02-08.06	62/71-81			0 204 123 615	25,4	
	2.3 JTD	ABO	04.02-08.06	81			0 204 123 616	25,4	
			01.08→	81			0 204 123 616	25,4	
		ABS	04.02-08.06	81			0 204 123 615	25,4	
			01.08→	81			0 204 123 615	25,4	
	2.3 JTD EGR	ABO	04.02-08.06	81			0 204 123 616	25,4	
			01.08→	81			0 204 123 616	25,4	
		ABS	04.02-08.06	81			0 204 123 615	25,4	
			01.08→	81			0 204 123 615	25,4	
	2.8 JTD EGR	ABO	04.02-08.06	94		AG	0 204 123 615	25,4	
						GS	0 204 123 616	25,4	
		ABS	04.02-08.06	94			0 204 123 615	25,4	
2.8 JTD	ABO	04.02-08.06	94/107			0 204 123 616	25,4		
2.8 JTD CGV	ABS	04.02-08.06	94/107			0 204 123 615	25,4		
2.8 TD	ABO	10.02-08.06	90			0 204 123 616	25,4		
2.8 TD EGR	ABS	10.02-08.06	90			0 204 123 615	25,4		
	2.0 i.e.		04.02-08.06	81			0 204 125 801		
		ABO	04.02-08.06	81			0 204 024 593 ²⁵		
		ABS	04.02-08.06	81			0 204 024 592 ²⁵		
	2.0 i.e. Bipower CNG		04.02-08.06	62/71-81			0 204 125 801		
	2.0 i.e. Bipower LPG	ABO	04.02-08.06	62/71-81			0 204 024 593 ²⁵		
	2.0 JTD	ABS	04.02-08.06	62/71-81			0 204 024 592 ²⁵		
	2.3 JTD		04.02-08.06	81			0 204 125 801		
			01.08→	81			0 204 125 801		
	2.3 JTD EGR		04.02-08.06	81			0 204 125 801		
			01.08→	81			0 204 125 801		
	2.3 JTD	ABO	04.02-08.06	81			0 204 024 593 ²⁵		
	2.3 JTD EGR	ABS	04.02-08.06	81			0 204 024 592 ²⁵		
	2.8 JTD		04.02-08.06	94/107			0 204 125 801		
	2.8 JTD CGV	ABO	04.02-08.06	94/107		GS	0 204 024 593 ²⁵		
	2.8 JTD EGR	ABS	04.02-08.06	94/107		GS	0 204 024 592 ²⁵		
2.8 TD		10.02-08.06	90			0 204 125 801			
2.8 TD EGR	ABO	10.02-08.06	90			0 204 024 593 ²⁵			
	ABS	10.02-08.06	90			0 204 024 592 ²⁵			
	2.0 i.e., i.e. Bipower CNG	ABO	04.02-08.06	62/71-81		DOP,FGS	0 204 031 183 ¹⁰		
	2.0 i.e. Bipower LPG, JTD					FEV	0 204 031 184 ¹⁰		
						KOB,KW	0 204 031 182 ¹⁰		
	2.3 JTD		01.08→	81			0 204 031 182 ¹⁰		
	2.3 JTD EGR	ABO	04.02-08.06	81		DOP,FGS	0 204 031 183 ¹⁰		
						FEV	0 204 031 184 ¹⁰		
						KOB,KW	0 204 031 182 ¹⁰		
2.8 JTD, JTD CGV, JTD EGR	ABO	04.02-08.06	90/94/107		DOP,FGS	0 204 031 183 ¹⁰			
2.8 TD, TD EGR					FEV	0 204 031 184 ¹⁰			
					KOB,KW	0 204 031 182 ¹⁰			
	2.0 i.e.		04.02-08.06	81		SBR	1 987 482 003	2715	
						TBR	1 987 477 263	2827	
	2.0 i.e. Bipower CNG		04.02-08.06	62/71-81		SBR	1 987 482 003	2715	
	2.0 i.e. Bipower LPG, JTD					TBR	1 987 477 263	2827	
	2.3 JTD		04.02-08.06	81		SBR	1 987 482 003	2715	
						TBR	1 987 477 263	2827	
			01.08→	81		TBR	1 987 477 263	2827	
	2.3 JTD EGR		04.02-08.06	81		SBR	1 987 482 003	2715	
						TBR	1 987 477 263	2827	
		01.08→	81		TBR	1 987 477 263	2827		





	◀ FIAT Ducato 15 [244..]						
	2.8 JTD, JTD CGV, JTD EGR	04.02-08.06	90/94/107	SBR	1987	482 003	2715
	2.8 TD, TD EGR			TBR	1987	477 263	2827

	2.0 i.e.	04.02-08.06	81		0 265	216 709 ¹¹	
	2.0 i.e. Bipower CNG	04.02-08.06	62/71-81		0 265	216 709 ¹¹	
	2.0 i.e. Bipower LPG, JTD						
	2.3 JTD	04.02-08.06	81		0 265	216 709 ¹¹	
		01.08→	81		0 265	216 709 ¹¹	
	2.3 JTD EGR	04.02-08.06	81		0 265	216 709 ¹¹	
		01.08→	81		0 265	216 709 ¹¹	
	2.8 JTD, JTD CGV, JTD EGR	04.02-08.06	90/94/107		0 265	216 709 ¹¹	
	2.8 TD, TD EGR						

	2.0 i.e., i.e. Bipower CNG	04.02-08.06	62/71-81/		0 265	006 673 ³	
	2.0 i.e. Bipower LPG, JTD		90/94/107	LAB	0 265	006 688 ⁴	
	2.3 JTD, JTD EGR			RAB	0 265	006 689 ⁴	
	2.8 JTD, JTD CGV, JTD EGR						
	2.8 TD, TD EGR						

Ducato 15 [247..]

	2.0 i.e. Bipower CNG 4x4	ABO	04.02-08.06	71-81/90/94	UE	1987	481 004	470
	2.0 i.e. 4x4	ABO	02.04-08.06	71-81/90/94	OE	1987	481 067	500
		ABS	04.02-08.06	71-81/90/94		1987	481 067	500
	2.8 JTD EGR 4x4, JTD 4x4	ABO	04.02-08.06	71-81/90/94	UE	1987	481 004	470
	2.8 TD EGR 4x4, TD 4x4	ABO	02.04-08.06	71-81/90/94	OE	1987	481 067	500
		ABS	04.02-08.06	71-81/90/94		1987	481 067	500

	2.0 i.e. Bipower CNG 4x4	ABO	04.02-08.06	71-81/94		1987	481 002 ¹	360
	2.0 i.e. 4x4	ABS	04.02-08.06	71-81/94	LAB	1987	481 018 ¹	385
					RAB	1987	481 019 ¹	385
	2.8 JTD EGR 4x4	ABO	04.02-08.06	71-81/94		1987	481 002 ¹	360
	2.8 JTD 4x4	ABS	04.02-08.06	71-81/94	LAB	1987	481 018 ¹	385
					RAB	1987	481 019 ¹	385
	2.8 TD EGR 4x4	ABO	10.02-08.06	90		1987	481 002 ¹	360
	2.8 TD 4x4	ABS	10.02-08.06	90	LAB	1987	481 018 ¹	385
					RAB	1987	481 019 ¹	385
	2.8 TD 4x4		10.02-08.06	90		1987	476 006 ¹	200
						1987	476 629 ²	160

	2.8 TD 4x4		10.02-08.06	90	APD	0986	475 906	↔ 26,99
--	------------	--	-------------	----	-----	------	----------------	---------

	2.0 i.e. Bipower CNG 4x4	ABO	04.02-08.06	71-81		0 204	123 616	25,4
	2.0 i.e. 4x4	ABS	04.02-08.06	71-81		0 204	123 615	25,4
	2.8 JTD EGR 4x4	ABO	04.02-08.06	94	AG	0 204	123 615	25,4
					GS	0 204	123 616	25,4
	2.8 JTD EGR 4x4, JTD 4x4	ABS	04.02-08.06	94		0 204	123 615	25,4
	2.8 JTD 4x4	ABO	04.02-08.06	94		0 204	123 616	25,4
	2.8 TD EGR 4x4	ABO	10.02-08.06	90		0 204	123 616	25,4
	2.8 TD 4x4	ABS	10.02-08.06	90		0 204	123 615	25,4



	2.0 i.e. Bipower CNG 4x4	04.02-08.06	71-81		0 204 125 801	
	2.0 i.e. 4x4	ABO 04.02-08.06	71-81		0 204 024 593 ²⁵	
		ABS 04.02-08.06	71-81		0 204 024 592 ²⁵	
	2.8 JTD EGR 4x4	04.02-08.06	94		0 204 125 801	
	2.8 JTD 4x4	ABO 04.02-08.06	94	GS	0 204 024 593 ²⁵	
		ABS 04.02-08.06	94	GS	0 204 024 592 ²⁵	
	2.8 TD EGR 4x4	10.02-08.06	90		0 204 125 801	
	2.8 TD 4x4	ABO 10.02-08.06	90		0 204 024 593 ²⁵	
	ABS 10.02-08.06	90		0 204 024 592 ²⁵		

	2.0 i.e. Bipower CNG 4x4	04.02-08.06	71-81	FEV	0 204 031 184 ¹⁰	
				FLR	0 204 031 183 ¹⁰	
		ABO 04.02-08.06	71-81	FKR	0 204 031 182 ¹⁰	
				KOB,KW	0 204 131 232 ¹⁰	
		ABS 04.02-08.06	71-81		0 204 031 050 ¹⁰	
	2.0 i.e. 4x4	ABO 04.02-08.06	81	KOB,KW	0 204 131 232 ¹⁰	
		ABS 04.02-08.06	81		0 204 031 050 ¹⁰	
	2.8 JTD EGR 4x4	04.02-08.06	94	FEV	0 204 031 184 ¹⁰	
	2.8 JTD 4x4			FLR	0 204 031 183 ¹⁰	
		ABO 04.02-08.06	94	FKR	0 204 031 182 ¹⁰	
				KOB,KW	0 204 131 232 ¹⁰	
				LAB,WIF	0 204 031 056 ¹⁰	
			RAB,WIF	0 204 131 232 ¹⁰		
	ABS 04.02-08.06	94		0 204 031 050 ¹⁰		
2.8 TD EGR 4x4	ABO 10.02-08.06	90	KOB,KW	0 204 131 232 ¹⁰		
2.8 TD 4x4			LAB,WIF	0 204 031 056 ¹⁰		
			RAB,WIF	0 204 131 232 ¹⁰		
	ABS 10.02-08.06	90		0 204 031 050 ¹⁰		

	2.0 i.e. 4x4	04.02-08.06	81/90/94		1 987 482 003	2715
	2.8 JTD EGR 4x4, JTD 4x4					
	2.8 TD EGR 4x4, TD 4x4					

	2.0 i.e. Bipower CNG 4x4, i.e. 4x4	04.02-08.06	71-81/90/94		0 265 216 707 ¹¹	
	2.8 JTD EGR 4x4, JTD 4x4					
	2.8 TD EGR 4x4, TD 4x4					

	2.0 i.e. Bipower CNG 4x4, i.e. 4x4	04.02-08.06	71-81/90/94		0 265 006 673 ³	
	2.8 JTD EGR 4x4, JTD 4x4					
	2.8 TD EGR 4x4, TD 4x4					

Ducato 15 [250..]



	2.2 JTD	06.06→	74/88/96/		0 204 902 000	← 48
	2.3 JTD		116		0 204 902 001	→ 48
	3.0 JTD					



	2.2 JTD	ESP 06.06→	74	GS	0 204 123 719	25,4
				HAG	0 204 123 723	25,4
	2.3 JTD	ESP 06.06→	88/96	GS	0 204 123 719	25,4
				HAG	0 204 123 723	25,4
	2.2 JTD	OFD 06.06→	74	GS	0 204 123 718	25,4
				HAG	0 204 123 722	25,4
2.3 JTD	OFD 06.06→	88/96	GS	0 204 123 718	25,4	
			HAG	0 204 123 722	25,4	



		S							
FIAT Ducato 15 [250..]									
	3.0 JTD	ESP	06.06→	116		GS	0 204 123 719	25,4	
						HAG	0 204 123 723	25,4	
		OFD	06.06→	116		GS	0 204 123 718	25,4	
						HAG	0 204 123 722	25,4	
	2.2 JTD	06.06→	74/88/96/	116		BSS	0 204 125 858		
	2.3 JTD					BSS	0 204 125 859		
	3.0 JTD								
	2.2 JTD	06.06→	74/88/96/	116		FKR,FMR	1 987 482 213	↔ 1593	
	2.3 JTD					FLR	1 987 482 214	↔ 335	
	3.0 JTD								
	2.2 JTD	06.06-01.08	74/88/96/	116			0 265 231 618 ¹¹		
	2.3 JTD						0 265 233 330 ¹⁴		
	3.0 JTD					06.06→	74/88/96/116	GS	0 265 234 069 ²⁶
	2.2 JTD	06.06→	74/88/96/	116			0 265 007 685 ³		
	2.3 JTD					FLR	0 265 007 833 ⁴		
	3.0 JTD								
Ducato 17 [250..]									
	2.2 JTD	06.06→	74/88/96/	116			0 204 902 000	← 48	
	2.3 JTD						0 204 902 001	→ 48	
	3.0 JTD								
	2.2 JTD	ESP	06.06→	74		GS	0 204 123 721	26,9	
						HAG	0 204 123 725	26,9	
		OFD	06.06→	74		GS	0 204 123 720	26,9	
						HAG	0 204 123 724	26,9	
	2.3 JTD	ESP	06.06→	88/96		GS	0 204 123 721	26,9	
						HAG	0 204 123 725	26,9	
		OFD	06.06→	88/96		GS	0 204 123 720	26,9	
						HAG	0 204 123 724	26,9	
	3.0 JTD	ESP	06.06→	116		GS	0 204 123 721	26,9	
						HAG	0 204 123 725	26,9	
		OFD	06.06→	116		GS	0 204 123 720	26,9	
						HAG	0 204 123 724	26,9	
	2.2 JTD	06.06→	74/88/96/	116		BSS	0 204 125 860		
	2.3 JTD					BSS	0 204 125 861		
	3.0 JTD								
	2.2 JTD	06.06→	74/88/96/	116		FKR,FMR	1 987 482 213	↔ 1593	
	2.3 JTD					FLR	1 987 482 214	↔ 335	
	3.0 JTD								
	2.2 JTD	06.06-01.08	74/88/96/	116			0 265 231 618 ¹¹		
	2.3 JTD						0 265 233 330 ¹⁴		
	3.0 JTD					06.06→	74/88/96/116	GS	0 265 234 069 ²⁶
	2.2 JTD	06.06→	74/88/96/	116			0 265 007 685 ³		
	2.3 JTD					FLR	0 265 007 833 ⁴		
	3.0 JTD								



Ducato 18 [232..]



	2.0 i.e. Bipower CNG	ABO 03.94-03.02	62/64/80/	OE	1 987 476 329	485
			85/90/94	UE	1 987 481 063	490
		ABS 03.94-03.02	62/64/80/85/90/94		1 987 476 329	485
	2.5 D	ABO 03.94-03.98	62/64/80/	OE	1 987 476 329	485
	2.5 TD		85/90/94	UE	1 987 481 063	490
	2.5 TD ECO	ABS 03.94-03.98	62/64/80/85/90/94		1 987 476 329	485
2.8 D, JTD, JTD EGR, TD, TD EGR	ABO 10.97-03.02	62/64/80/	OE	1 987 476 329	485	
		85/90/94	UE	1 987 481 063	490	
	ABS 10.97-03.02	62/64/80/85/90/94		1 987 476 329	485	

	2.0 i.e. Bipower CNG	ABO 03.94-03.02	80		0 986 473 163	↔ 44,95
					0 986 474 163	↔ 44,95
	2.5 D, TD, TD ECO	ABO 03.94-03.02	62/64/80/	MIH	0 986 473 163	↔ 44,95
2.8 D, JTD, JTD EGR, TD, TD EGR		85/90/94		0 986 474 163	↔ 44,95	



	2.0 i.e. Bipower CNG	ABO 03.94-03.02	62/64/80/85/90/94	FEN	1 987 481 017 ¹	360
		ABS 03.94-03.02	62/64/80/	FEN,LAB	1 987 476 689 ¹	335
			85/90/94	LVF	1 987 481 018 ¹	385
				RNF	1 987 481 061	360
					1 987 481 061 ¹	360
		RVF	1 987 481 019 ¹	385		
	2.5 D	ABO 03.94-03.98	62/64/80/85/90/94	FEN	1 987 481 017 ¹	360
	2.5 TD	ABS 03.94-03.98	62/64/80/	FEN,LAB	1 987 476 689 ¹	335
	2.5 TD ECO		85/90/94	LVF	1 987 481 018 ¹	385
				RNF	1 987 481 061	360
					1 987 481 061 ¹	360
	RVF	1 987 481 019 ¹	385			
2.8 D, JTD, JTD EGR, 2.8 TD, TD EGR	ABO 10.97-03.02	62/64/80/85/90/94	FEN	1 987 481 017 ¹	360	
		ABS 10.97-03.02	62/64/80/	FEN,LAB	1 987 476 689 ¹	335
		85/90/94	LVF	1 987 481 018 ¹	385	
			RNF	1 987 481 061	360	
				1 987 481 061 ¹	360	
	RVF	1 987 481 019 ¹	385			

	2.0 i.e. Bipower CNG	03.94-03.02	62/64/80/		0 986 475 803	↔ 28,6
	2.5 D, TD, TD ECO		85/90/94			
	2.8 D, JTD, JTD EGR					
	2.8 TD, TD EGR					



	2.0 i.e. Bipower CNG	ABO 03.94-03.02	80	Fg.Nr. →5687087	RLE	0 204 123 314	25,4
				Fg.Nr. →6194400	LLE	F 026 003 313	25,4
				Fg.Nr. 6194401→		0 204 123 616	25,4
		ABS 03.94-03.02	80	Fg.Nr. →6194400		F 026 003 315	25,4
				Fg.Nr. 6194401→		0 204 123 615	25,4
	2.5 D	ABO 03.94-03.98	62/80/85		LLE	F 026 003 313	25,4
	2.5 TD				RLE	0 204 123 314	25,4
	2.5 TD ECO	ABS 03.94-03.98	62/80/85			F 026 003 315	25,4
	2.8 D	ABO 04.98-03.02	64	Fg.Nr. →5687087	RLE	0 204 123 314	25,4
				Fg.Nr. →6194400	LLE	F 026 003 313	25,4
				Fg.Nr. 6194401→		0 204 123 616	25,4
				Fg.Nr. 6194401→		0 204 123 615	25,4



		S							
◀ FIAT Ducato 18 [232..]									
2.8 JTD	ABO	08.00-03.02	94	Fg.Nr. →6194400	LLE	F 026	003 313	25,4	
2.8 JTD EGR				Fg.Nr. 6194401→		0 204	123 616	25,4	
	ABS	08.00-03.02	94	Fg.Nr. →6194400		F 026	003 315	25,4	
				Fg.Nr. 6194401→		0 204	123 615	25,4	
2.8 TD	ABO	10.97-03.02	90	Fg.Nr. →5687087	RLE	0 204	123 314	25,4	
2.8 TD EGR				Fg.Nr. →6194400	LLE	F 026	003 313	25,4	
				Fg.Nr. 6194401→		F 026	003 313	25,4	
	ABS	10.97-03.02	90			F 026	003 315	25,4	
2.0 i.e. Bipower CNG		03.94-08.00	80	Fg.Nr. 5687088→5984271		0 204	125 746		
		03.94-03.02	80	Fg.Nr. 5984272→6194400		0 204	125 772		
				Fg.Nr. 6194401→		0 204	125 801		
	ABO	12.01-03.02	80	Fg.Nr. 6194401→		0 204	024 593²⁵		
	ABS	03.94-03.02	80	Fg.Nr. 6194401→		0 204	024 592²⁵		
2.8 D		04.98-08.00	64	Fg.Nr. 5687088→5984271		0 204	125 746		
		04.98-03.02	64	Fg.Nr. 5984272→6194400		0 204	125 772		
				Fg.Nr. 6194401→		0 204	125 801		
2.8 JTD		08.00-03.02	94	Fg.Nr. →6194400		0 204	125 772		
2.8 JTD EGR				Fg.Nr. 6194401→		0 204	125 801		
	ABO	12.01-03.02	94	Fg.Nr. 6194401→		0 204	024 593²⁵		
	ABS	08.00-03.02	94	Fg.Nr. 6194401→		0 204	024 592²⁵		
2.8 TD		10.97-08.00	90	Fg.Nr. 5687088→5984271		0 204	125 746		
2.8 TD EGR		10.97-03.02	90	Fg.Nr. 5984272→		0 204	125 772		
2.0 i.e. Bipower CNG	ABO	03.94-03.02	80			0 204	131 232¹⁰		
	ABS	03.94-07.97	80	Fg.Nr. →5445358		0 204	031 050¹⁰		
2.5 D	ABO	03.94-03.98	62/80/85		LAB,WIF	0 204	031 056¹⁰		
2.5 TD					RAB	0 204	131 232¹⁰		
2.5 TD ECO	ABS	03.94-07.97	62/80/85	Fg.Nr. →5445358		0 204	031 050¹⁰		
2.8 D, JTD, JTD EGR	ABO	10.97-03.02	64/90/94		LAB,WIF	0 204	031 056¹⁰		
2.8 TD, TD EGR					RAB	0 204	131 232¹⁰		
2.0 i.e. Bipower CNG		03.94-11.01	80		LLE	1 987	477 114	1059	
					RLE	1 987	482 046	1137	
				Fg.Nr. 6158429→	FEN	1 987	477 262	2806	
					FEV	1 987	482 006	2827	
		03.94-03.02	80	Fg.Nr. →6158428	FEN	1 987	477 113	3025	
					FEV	1 987	477 115	3040	
		12.01-03.02	80		LLE	1 987	482 002	1078	
					RLE	1 987	482 004	1170	
					SBR	1 987	482 003	2715	
					TBR	1 987	477 263	2827	
2.5 D		03.94-03.98	62		LLE	1 987	477 114	1059	
					RLE	1 987	482 046	1137	
				Fg.Nr. →6158428	FEN	1 987	477 113	3025	
					FEV	1 987	477 115	3040	
2.5 TD		03.94-03.98	80/85		LLE	1 987	477 114	1059	
2.5 TD ECO					RLE	1 987	482 046	1137	
				Fg.Nr. →6158428	FEN	1 987	477 113	3025	
					FEV	1 987	477 115	3040	
				Fg.Nr. 6158429→	FEN	1 987	477 262	2806	
					FEV	1 987	482 006	2827	
2.8 D		10.97-11.01	64/90/94		LLE	1 987	477 114	1059	
2.8 JTD					RLE	1 987	482 046	1137	
2.8 JTD EGR				Fg.Nr. 6158429→	FEN	1 987	477 262	2806	
2.8 TD					FEV	1 987	482 006	2827	
2.8 TD EGR		10.97-03.02	64/90/94	Fg.Nr. →6158428	FEN	1 987	477 113	3025	
					FEV	1 987	477 115	3040	
		12.01-03.02	64/90/94		LLE	1 987	482 002	1078	
					RLE	1 987	482 004	1170	
					SBR	1 987	482 003	2715	
					TBR	1 987	477 263	2827	



	2.0 i.e. Bipower CNG	08.97-11.01	80	Fg.Nr. 5445359→6194400	L02	BO	0 265 216 530 ¹¹	
		12.01-03.02	80	Fg.Nr. 6194401→		BO	0 265 216 709 ¹¹	
	2.5 D, TD, TD ECO	08.97-03.98	62/80/85	Fg.Nr. 5445359→6194400	L02	BO	0 265 216 530 ¹¹	
	2.8 D, JTD, JTD EGR	10.97-11.01	64/90/94	Fg.Nr. 5445359→6194400	L02	BO	0 265 216 530 ¹¹	
	2.8 TD, TD EGR	12.01-03.02	64/90/94	Fg.Nr. 6194401→		BO	0 265 216 709 ¹¹	

	2.0 i.e. Bipower CNG	03.94-03.02	80	Fg.Nr. 5946343→		BSY	0 265 006 673 ³	
		08.97-11.01	80	Fg.Nr. 5445359→	LAB	BO	0 265 006 405 ⁴	
					RAB	BO	0 265 006 406 ⁴	
		08.97-03.02	80	Fg.Nr. 5445359→5946342		BO	0 265 006 427 ³	
		12.01-03.02	80		LAB		0 265 006 688 ⁴	
					RAB		0 265 006 689 ⁴	
	2.5 D	08.97-03.98	62/80/85	Fg.Nr. 5445359→		BO	0 265 006 427 ³	
	2.5 TD				LAB	BO	0 265 006 405 ⁴	
	2.5 TD ECO				RAB	BO	0 265 006 406 ⁴	
	2.8 D	04.98-11.01	64	Fg.Nr. 5445359→	LAB	BO	0 265 006 405 ⁴	
					RAB	BO	0 265 006 406 ⁴	
		04.98-03.02	64	Fg.Nr. 5445359→5946342		BO	0 265 006 427 ³	
				Fg.Nr. 5946343→		BSY	0 265 006 673 ³	
		12.01-03.02	64		LAB		0 265 006 688 ⁴	
				RAB		0 265 006 689 ⁴		
2.8 JTD	08.00-11.01	94	Fg.Nr. 5445359→	LAB	BO	0 265 006 405 ⁴		
2.8 JTD EGR				RAB	BO	0 265 006 406 ⁴		
	08.00-03.02	94	Fg.Nr. 5946343→		BSY	0 265 006 673 ³		
	12.01-03.02	94		LAB		0 265 006 688 ⁴		
				RAB		0 265 006 689 ⁴		
2.8 TD	10.97-11.01	90	Fg.Nr. 5445359→	LAB	BO	0 265 006 405 ⁴		
2.8 TD EGR				RAB	BO	0 265 006 406 ⁴		
	10.97-03.02	90	Fg.Nr. 5445359→5946342		BO	0 265 006 427 ³		
			Fg.Nr. 5946343→		BSY	0 265 006 673 ³		
	12.01-03.02	90		LAB		0 265 006 688 ⁴		
				RAB		0 265 006 689 ⁴		



Ducato 18 [234..]



	2.5 D 4x4	ABO	03.94-03.98	62/64/85/		OE	1 987 476 329	485
	2.5 TD 4x4			90/94		UE	1 987 481 063	490
		ABS	03.94-03.98	62/64/85/90/94			1 987 476 329	485
	2.8 D 4x4, JTD EGR 4x4, JTD 4x4	ABO	10.97-03.02	62/64/85/		OE	1 987 476 329	485
2.8 TD EGR 4x4, TD 4x4			90/94		UE	1 987 481 063	490	
	ABS	10.97-03.02	62/64/85/90/94			1 987 476 329	485	

	2.5 D 4x4, TD 4x4	ABO	03.94-03.02	62/64/85		MIH	0 986 473 163	☹ ← 44,95
	2.8 D 4x4						0 986 474 163	☹ → 44,95
	2.8 JTD EGR 4x4	ABO	08.00-03.02	94			0 986 473 162	☹ ← 40,39
							0 986 474 162	☹ → 40,39
						MIH	0 986 473 163	☹ ← 44,95
							0 986 474 163	☹ → 44,95
2.8 JTD 4x4	ABO	08.00-03.02	94		MIH	0 986 473 163	☹ ← 44,95	
						0 986 474 163	☹ → 44,95	
2.8 TD EGR 4x4, TD 4x4	ABO	10.97-03.02	90		MIH	0 986 473 163	☹ ← 44,95	
						0 986 474 163	☹ → 44,95	



	2.5 D 4x4, TD 4x4	ABO	03.94-03.98	62/85		FEN	1 987 481 017 ¹	360
--	-------------------	-----	-------------	-------	--	-----	----------------------------	-----

FIAT Ducato 18 [234..]									
2.8 D 4x4	ABS	10.97-03.02	64/90/94		FEN,LAB	1987 476 689 ¹	335		
2.8 JTD EGR 4x4					LVF	1987 481 018 ¹	385		
2.8 JTD 4x4					RNF	1987 481 061	360		
2.8 TD EGR 4x4						1987 481 061 ¹	360		
2.8 TD 4x4					RVF	1987 481 019 ¹	385		
2.5 D 4x4, TD 4x4		03.94-03.02	62/64/85/			0986 475 803		↔ 28,6	
2.8 D 4x4, TD EGR 4x4, TD 4x4			90						
2.5 D 4x4	ABO	03.94-03.98	62/85		LLE	F 026 003 313	25,4		
2.5 TD 4x4				Fg.Nr. →5687087	RLE	0 204 123 314	25,4		
	ABS	03.94-03.98	62/85			F 026 003 315	25,4		
2.8 D 4x4	ABO	04.98-03.02	64	Fg.Nr. →6194400	RLE	0 204 123 314	25,4		
				Fg.Nr. 6194401→	LLE	F 026 003 313	25,4		
						0 204 123 616	25,4		
	ABS	04.98-03.02	64	Fg.Nr. →6194400		F 026 003 315	25,4		
				Fg.Nr. 6194401→		0 204 123 615	25,4		
2.8 JTD EGR 4x4	ABO	08.00-03.02	94	Fg.Nr. →6194400	LLE	F 026 003 313	25,4		
2.8 JTD 4x4				Fg.Nr. 6194401→		0 204 123 616	25,4		
	ABS	08.00-03.02	94	Fg.Nr. →6194400		F 026 003 315	25,4		
				Fg.Nr. 6194401→		0 204 123 615	25,4		
2.8 TD EGR 4x4	ABO	10.97-03.02	90	Fg.Nr. →5687087	RLE	0 204 123 314	25,4		
2.8 TD 4x4				Fg.Nr. →6194400	LLE	F 026 003 313	25,4		
				Fg.Nr. 6194401→		F 026 003 313	25,4		
	ABS	10.97-03.02	90			F 026 003 315	25,4		
2.5 D 4x4, TD 4x4		03.94-03.98	62/85	Fg.Nr. 5687088→		0 204 125 746			
2.8 D 4x4		04.98-08.00	64	Fg.Nr. 5687088→5984271		0 204 125 746			
		04.98-03.02	64	Fg.Nr. 5984272→6194400		0 204 125 772			
				Fg.Nr. 6194401→		0 204 125 801			
2.8 JTD EGR 4x4		08.00-03.02	94	Fg.Nr. 5971211→5984271		0 204 125 746			
2.8 JTD 4x4				Fg.Nr. 5984272→6194400		0 204 125 772			
				Fg.Nr. 6194401→		0 204 125 801			
	ABO	12.01-03.02	94	Fg.Nr. 6194401→		0 204 024 593 ²⁵			
	ABS	08.00-03.02	94	Fg.Nr. 6194401→		0 204 024 592 ²⁵			
2.8 TD EGR 4x4		10.97-08.00	90	Fg.Nr. 5687088→5984271		0 204 125 746			
2.8 TD 4x4		10.97-03.02	90	Fg.Nr. 5984272→		0 204 125 772			
2.5 D 4x4, TD 4x4	ABS	03.94-07.97	62/85	Fg.Nr. →5445358		0 204 031 050 ¹⁰			
2.8 JTD EGR 4x4	ABO	08.00-03.02	94		LAB,WIF	0 204 031 056 ¹⁰			
2.8 JTD 4x4					RAB	0 204 131 232 ¹⁰			
2.5 D 4x4		03.94-03.98	62		FEV	1987 477 115	3040		
					FMR	1987 477 113	3025		
					LLE	1987 477 114	1059		
					RLE	1987 482 046	1137		
2.5 TD 4x4		03.94-03.98	85		FMR	1987 477 113	3025		
					LLE	1987 477 114	1059		
					RLE	1987 482 046	1137		
				Fg.Nr. →6158428	FEV	1987 477 115	3040		
2.8 D 4x4		04.98-11.01	64		LLE	1987 477 114	1059		
					RLE	1987 482 046	1137		
				Fg.Nr. 6158429→	FEN	1987 477 262	2806		
					FEV	1987 482 006	2827		
		04.98-03.02	64	Fg.Nr. →6158428	FEN	1987 477 113	3025		
					FEV	1987 477 115	3040		
		12.01-03.02	64		LLE	1987 482 002	1078		
					RLE	1987 482 004	1170		
					SBR	1987 482 003	2715		
					TBR	1987 477 263	2827		

	S							
2.8 JTD EGR 4x4	10.97-11.01	90/94			FEV	1 987 477 115	3040	
2.8 JTD 4x4					FMR	1 987 477 113	3025	
2.8 TD EGR 4x4					LLE	1 987 477 114	1059	
2.8 TD 4x4					RLE	1 987 482 046	1137	
	12.01-03.02	90/94			LLE	1 987 482 002	1078	
					RLE	1 987 482 004	1170	
					SBR	1 987 482 003	2715	
					TBR	1 987 477 263	2827	

	2.5 D 4x4, TD 4x4	08.97-03.98	62/85	Fg.Nr. 5445359→6194400	L02	BO	0 265 216 530 ¹¹	
	2.8 D 4x4, JTD EGR 4x4, JTD 4x4	10.97-11.01	64/90/94	Fg.Nr. 5445359→6194400	L02	BO	0 265 216 530 ¹¹	
	2.8 TD EGR 4x4, TD 4x4	12.01-03.02	64/90/94	Fg.Nr. 6194401→		BO	0 265 216 709 ¹¹	

	2.5 D 4x4	08.97-03.98	62/85	Fg.Nr. 5445359→	LAB	BO	0 265 006 405 ⁴	
	2.5 TD 4x4				RAB	BO	0 265 006 406 ⁴	
				Fg.Nr. 5445359→5946342		BO	0 265 006 427 ³	
	2.8 D 4x4	10.97-11.01	64/90/94	Fg.Nr. 5445359→	LAB	BO	0 265 006 405 ⁴	
	2.8 JTD EGR 4x4				RAB	BO	0 265 006 406 ⁴	
	2.8 JTD 4x4	10.97-03.02	64/90/94	Fg.Nr. 5445359→5946342		BO	0 265 006 427 ³	
	2.8 TD EGR 4x4			Fg.Nr. 5946343→		BSY	0 265 006 673 ³	
	2.8 TD 4x4	12.01-03.02	64/90/94		LAB		0 265 006 688 ⁴	
					RAB		0 265 006 689 ⁴	

Ducato 18 [245..]

	2.0 i.e.	ABO	04.02-08.06	71-81		UE	1 987 481 004	470
	2.0 i.e. Bipower CNG		02.04-08.06	71-81		OE	1 987 481 067	500
		ABS	04.02-08.06	71-81			1 987 481 067	500
	2.3 JTD	ABO	04.02-08.06	81		UE	1 987 481 004	470
			02.04-08.06	81		OE	1 987 481 067	500
			01.08→	81		OE	1 987 481 067	500
						UE	1 987 481 004	470
		ABS	04.02-08.06	81			1 987 481 067	500
			01.08→	81			1 987 481 067	500
	2.3 JTD EGR	ABO	01.08→	81		OE	1 987 481 067	500
						UE	1 987 481 004	470
		ABS	01.08→	81/94			1 987 481 067	500
	2.8 JTD	ABO	04.02-08.06	81/94		UE	1 987 481 004	470
			02.04-08.06	81/94		OE	1 987 481 067	500
	2.8 JTD CGV, JTD EGR, TD	ABO	04.02-08.06	90/94/107		UE	1 987 481 004	470
			02.04-08.06	90/94/107		OE	1 987 481 067	500
	2.8 JTD, JTD CGV, JTD EGR, TD	ABS	04.02-08.06	90/94/107			1 987 481 067	500

	2.0 i.e.	ABO	04.02-08.06	71-81			1 987 481 002 ¹	360
	2.0 i.e. Bipower CNG	ABS	04.02-08.06	71-81		LAB	1 987 481 018 ¹	385
						RAB	1 987 481 019 ¹	385
	2.3 JTD	ABO	04.02-08.06	81			1 987 481 002 ¹	360
			01.08→	81			1 987 481 002 ¹	360
		ABS	04.02-08.06	81		LAB	1 987 481 018 ¹	385
						RAB	1 987 481 019 ¹	385
			01.08→	81		LAB	1 987 481 018 ¹	385
						RAB	1 987 481 019 ¹	385
	2.3 JTD EGR	ABO	01.08→	81			1 987 481 002 ¹	360
		ABS	01.08→	81		LAB	1 987 481 018 ¹	385
						RAB	1 987 481 019 ¹	385
	2.8 JTD, JTD CGV, JTD EGR, TD	ABO	04.02-08.06	90/94/107			1 987 481 002 ¹	360
		ABS	04.02-08.06	90/94/107		LAB	1 987 481 018 ¹	385
						RAB	1 987 481 019 ¹	385





◀ FIAT Ducato 18 [245..]

	2.0 i.e., i.e. Bipower CNG 2.3 JTD 2.8 JTD, JTD CGV, JTD EGR, TD	04.02-08.06	71-81/90/ 94/107	APD	0 986 475 906	↔ 26,99
--	--	-------------	---------------------	-----	----------------------	---------



	2.0 i.e.	ABO 04.02-08.06	81		0 204 123 616	25,4
		ABS 04.02-08.06	81		0 204 123 615	25,4
	2.0 i.e. Bipower CNG	ABO 04.02-08.06	71-81		0 204 123 616	25,4
		ABS 04.02-08.06	71-81		0 204 123 615	25,4
	2.3 JTD	ABO 04.02-08.06	81		0 204 123 616	25,4
		01.08 →	81		0 204 123 616	25,4
		ABS 04.02-08.06	81		0 204 123 615	25,4
		01.08 →	81		0 204 123 615	25,4
2.3 JTD EGR	ABO 01.08 →	81		0 204 123 616	25,4	
	ABS 01.08 →	81		0 204 123 615	25,4	
2.8 JTD, JTD CGV, JTD EGR, TD	ABO 04.02-08.06	90/94/107		0 204 123 616	25,4	
	ABS 04.02-08.06	90/94/107		0 204 123 615	25,4	

	2.0 i.e.	04.02-08.06	81		0 204 125 801	
		ABO 04.02-08.06	81		0 204 024 593 ²⁵	
	2.0 i.e. Bipower CNG	ABS 04.02-08.06	81		0 204 024 592 ²⁵	
		04.02-08.06	71-81		0 204 125 801	
	2.3 JTD	ABO 04.02-08.06	71-81		0 204 024 593 ²⁵	
		ABS 04.02-08.06	71-81		0 204 024 592 ²⁵	
	2.3 JTD EGR	04.02-08.06	81		0 204 125 801	
		01.08 →	81		0 204 125 801	
		ABO 04.02-08.06	81		0 204 024 593 ²⁵	
		ABS 04.02-08.06	81		0 204 024 592 ²⁵	
2.8 JTD EGR	01.08 →	81		0 204 125 801		
2.8 JTD	2.8 JTD CGV	04.02-08.06	94		0 204 125 801	
		ABO 04.02-08.06	94	GS	0 204 024 593 ²⁵	
		ABS 04.02-08.06	94	GS	0 204 024 592 ²⁵	
2.8 TD	04.02-08.06	94/107		0 204 125 801		
2.8 TD	2.8 TD	ABO 04.02-08.06	94/107		0 204 024 593 ²⁵	
		ABS 04.02-08.06	94/107		0 204 024 592 ²⁵	
		10.02-08.06	90		0 204 125 801	
	2.8 TD	ABO 10.02-08.06	90		0 204 024 593 ²⁵	
		ABS 10.02-08.06	90		0 204 024 592 ²⁵	

	2.0 i.e.	ABO 04.02-08.06	71-81	FEV	0 204 031 202 ¹⁰	
				FKR	0 204 031 182 ¹⁰	
	2.0 i.e. Bipower CNG	ABO 04.02-08.06	81	FLR,FMR	0 204 031 185 ¹⁰	
				FEV	0 204 031 202 ¹⁰	
				FKR	0 204 031 182 ¹⁰	
2.3 JTD	2.3 JTD	ABO 04.02-08.06	81	FLR,FMR	0 204 031 185 ¹⁰	
				FEV	0 204 031 202 ¹⁰	
				FKR	0 204 031 182 ¹⁰	
2.3 JTD, JTD EGR	2.3 JTD, JTD EGR	01.08 →	81		0 204 031 185 ¹⁰	
2.8 JTD, JTD CGV, JTD EGR, TD	2.8 JTD, JTD CGV, JTD EGR, TD	ABO 04.02-08.06	90/94/107	FEV	0 204 031 202 ¹⁰	
				FKR	0 204 031 182 ¹⁰	
				FLR,FMR	0 204 031 185 ¹⁰	

	2.0 i.e.	04.02-08.06	81	SBR	1 987 482 003	2715
				TBR	1 987 477 263	2827
	2.0 i.e. Bipower CNG	04.02-08.06	71-81	SBR	1 987 482 003	2715
				TBR	1 987 477 263	2827
2.3 JTD	2.3 JTD	04.02-08.06	81	SBR	1 987 482 003	2715
				TBR	1 987 477 263	2827
	2.3 JTD EGR	01.08 →	81	SBR	1 987 482 003	2715
				TBR	1 987 477 263	2827
2.8 JTD, JTD CGV, JTD EGR, TD	2.8 JTD, JTD CGV, JTD EGR, TD	04.02-08.06	90/94/107	SBR	1 987 482 003	2715
				TBR	1 987 477 263	2827



	2.0 i.e.	04.02-08.06	81		0 265 216 709 ¹¹	
	2.0 i.e. Bipower CNG	04.02-08.06	71-81		0 265 216 709 ¹¹	
	2.3 JTD	04.02-08.06	81		0 265 216 709 ¹¹	
		01.08→	81		0 265 216 709 ¹¹	
	2.3 JTD EGR	01.08→	81		0 265 216 709 ¹¹	
	2.8 JTD	04.02-08.06	94		0 265 216 709 ¹¹	
	2.8 JTD CGV	04.04-08.06	107		0 265 216 707 ¹¹	
2.8 JTD EGR, TD	04.02-08.06	90/94		0 265 216 709 ¹¹		

	2.0 i.e., i.e. Bipower CNG	04.02-08.06	71-81/90/		0 265 006 673 ³	
	2.3 JTD		94/107	LAB	0 265 006 688 ⁴	
	2.8 JTD, JTD CGV, JTD EGR, TD			RAB	0 265 006 689 ⁴	

Ducato 18 [247..]



	2.0 i.e. Bipower CNG 4x4	ABO	04.02-08.06	71-81/90/94	UE	1 987 481 004	470
	2.0 i.e. 4x4		02.04-08.06	71-81/90/94	OE	1 987 481 067	500
		ABS	04.02-08.06	71-81/90/94		1 987 481 067	500
	2.8 JTD EGR 4x4	ABO	04.02-08.06	71-81/90/94	UE	1 987 481 004	470
	2.8 JTD 4x4		02.04-08.06	71-81/90/94	OE	1 987 481 067	500
	2.8 TD 4x4	ABS	04.02-08.06	71-81/90/94		1 987 481 067	500



	2.0 i.e. Bipower CNG 4x4	ABO	04.02-08.06	71-81/90/		1 987 481 017 ¹	360
	2.0 i.e. 4x4			94			
	2.8 JTD EGR 4x4, JTD 4x4						
	2.8 TD 4x4						



	2.0 i.e. Bipower CNG 4x4	ABO	04.02-08.06	71-81/90/94		0 204 123 616	25,4
	2.0 i.e. 4x4	ABS	04.02-08.06	71-81/90/94		0 204 123 615	25,4
	2.8 JTD EGR 4x4, JTD 4x4	ABO	04.02-08.06	71-81/90/94		0 204 123 616	25,4
	2.8 TD 4x4	ABS	04.02-08.06	71-81/90/94		0 204 123 615	25,4

	2.0 i.e. Bipower CNG 4x4		04.02-08.06	71-81		0 204 125 801	
	2.0 i.e. 4x4	ABO	04.02-08.06	71-81		0 204 024 593 ²⁵	
		ABS	04.02-08.06	71-81		0 204 024 592 ²⁵	
	2.8 JTD EGR 4x4	ABO	04.02-08.06	94	GS	0 204 024 593 ²⁵	
		ABS	04.02-08.06	94	GS	0 204 024 592 ²⁵	
	2.8 JTD EGR 4x4, JTD 4x4		04.02-08.06	94		0 204 125 801	
	2.8 JTD 4x4	ABO	04.02-08.06	94		0 204 024 593 ²⁵	
		ABS	04.02-08.06	94		0 204 024 592 ²⁵	
	2.8 TD 4x4		10.02-08.06	90		0 204 125 801	
		ABO	10.02-08.06	90		0 204 024 593 ²⁵	
		ABS	10.02-08.06	90		0 204 024 592 ²⁵	

	2.0 i.e. Bipower CNG 4x4	ABO	04.02-08.06	71-81	FEV	0 204 031 202 ¹⁰	
	2.0 i.e. 4x4				FKR	0 204 031 182 ¹⁰	
					FLR,FMR	0 204 031 185 ¹⁰	
					KOB,KW	0 204 131 232 ¹⁰	
		ABS	04.02-08.06	71-81		0 204 031 050 ¹⁰	
	2.8 JTD EGR 4x4	ABO	04.02-08.06	94	FEV	0 204 031 202 ¹⁰	
	2.8 JTD 4x4				FKR	0 204 031 182 ¹⁰	
					FLR,FMR	0 204 031 185 ¹⁰	
					KOB,KW	0 204 131 232 ¹⁰	
					LAB,WIF	0 204 031 056 ¹⁰	
					RAB,WIF	0 204 131 232 ¹⁰	
		ABS	04.02-08.06	94		0 204 031 050 ¹⁰	

























2.8 TD 4x4		ABO 10.02-08.06 90		KOB,KW		0 204 131 232 ¹⁰			
				LAB,WIF		0 204 031 056 ¹⁰			
				RAB,WIF		0 204 131 232 ¹⁰			
		ABS 10.02-08.06 90				0 204 031 050 ¹⁰			
2.0 i.e. 4x4		04.02-08.06 81/90/94				1987 482 003		2715	
2.8 JTD EGR 4x4, JTD 4x4									
2.8 TD 4x4									
2.0 i.e. Bipower CNG 4x4		04.02-08.06 71-81/90/				0 265 216 707 ¹¹			
2.0 i.e. 4x4		94							
2.8 JTD EGR 4x4, JTD 4x4									
2.8 TD 4x4									
2.0 i.e. Bipower CNG 4x4		04.02-08.06 71-81/90/				0 265 006 673 ³			
2.0 i.e. 4x4		94							
2.8 JTD EGR 4x4, JTD 4x4									
2.8 TD 4x4									

Ducato 18 [280..]

		2.0, Maxi		01.86-06.90 55/63/68		OE,ZE		1 987 476 462		435
		2.5 D Maxi, TD Maxi				UE,ZE		1 987 476 463		435
		2.5 D Maxi		01.86-06.90 55				0 986 473 776		38
								0 986 473 777		38
		2.0, Maxi		01.86-06.90 55/63/68				1 987 476 688 ¹		290
		2.5 D Maxi, TD Maxi								
		2.0		01.86-06.90 55/63/68				0 986 475 612		27
		2.5 D Maxi								
		2.5 TD Maxi								
		2.0		06.86-06.90 63		LLE		0 204 125 345 ²⁵		
		2.0 Maxi				Fg.Nr. ->TEL0476624		RLE		0 204 125 345 ²⁵
		2.5 D Maxi, TD Maxi		01.86-06.90 55/68				LLE		0 204 125 345 ²⁵
		2.0		06.86-06.90 63				1 987 477 515		2566
		2.0 Maxi								

Ducato 18 [282..]

		2.0 Maxi		07.90-02.94 55/63/70		OE,ZE		1 987 476 462		435
		2.5 D Maxi				UE,ZE		1 987 476 463		435
		2.5 TD Maxi								
		2.5 D Maxi		07.90-02.94 55		MH		0 986 473 776		38
								0 986 473 777		38

		S							
									
	2.0 Maxi 2.5 D Maxi 2.5 TD Maxi	07.90-02.94	55/63/70				1 987 476 688 ¹	290	
	2.0 Maxi 2.5 D Maxi 2.5 TD Maxi	07.90-02.94	55/63/70				0 986 475 612	↔ 27	
									
	2.0 Maxi	07.90-02.94	63		LLE		0 204 125 550 ²⁵		
					RLE		0 204 125 422 ²⁵		
	2.5 D Maxi, TD Maxi	07.90-02.94	55/70				0 204 125 550 ²⁵		
	2.0 Maxi	07.90-02.94	63				1 987 477 515	2566	
						RLE	1 987 477 421	2377	
Fiorino Furgao									
									
	1.0, SPI	01.94-11.95	35/42				1 987 481 190	385	
	1.3 MPI 8V	02.03-12.06	49				1 987 481 190	385	
	1.5 MPI	09.97-06.02	56				1 987 481 190	385	
									
	1.0	01.94-11.95	35/42				0 204 032 301	22,21	
	1.0 SPI						0 204 032 601		
	1.3 MPI	01.03-09.04	49				0 204 032 601		
		ABO 01.03-09.04	49			BSY	0 204 032 301	22,21	
	1.3 MPI 8V	02.03-12.08	49				0 204 032 301	22,21	
							0 204 032 601		
	1.5 MPI	09.97-06.02	56				0 204 032 301	22,21	
						0 204 032 601			
	1.7 D	01.04-12.08	52				0 204 032 301	22,21	
							0 204 032 601		
	1.0, SPI	01.94-11.95	35/42				0 204 032 359		
	1.3 MPI	01.03-09.04	49			BSY	0 204 032 926		
	1.3 MPI 8V	01.04-12.08	49				0 204 032 926		
	1.5 MPI	09.97-06.02	56				0 204 032 359		
	1.7 D	01.04-12.08	52				0 204 032 926		
	1.0, SPI	01.94-11.95	35/42				1 987 477 989	3105	
	1.3 MPI, MPI 8V	01.03-12.08	49				1 987 477 989	3105	
	1.5 MPI	09.97-06.02	56				1 987 477 989	3105	
	1.7 D	01.04-12.08	52				1 987 477 989	3105	
	1.3 MPI 8V	02.03-12.06	49			CSA, LAB	0 265 006 539 ⁴		
						LAB	0 265 006 538 ³		
						RAB	0 265 006 537 ³		
							0 265 006 540 ⁴		
	1.5 MPI	09.97-06.02	56			CSA, LAB	0 265 006 539 ⁴		
						LAB	0 265 006 538 ³		
						RAB	0 265 006 537 ³		
						0 265 006 540 ⁴			





Fiorino Pick-up

	1.5	12.88-10.93	52		1987 481 190	385
	1.5 MPI	09.97-06.02	56		1987 481 190	385
	1.6	05.91-10.94	66		1987 481 190	385
	1.6 MPI	10.95-10.96	66		1987 481 190	385

	1.5	12.88-10.94	52/66	ATE	F 026 002 454	↔ 19,05
	1.6					

	1.5 MPI	09.97-06.02	56		0 204 032 301	22,21
					0 204 032 601	
	1.6 MPI	10.95-10.96	66		0 204 032 301	22,21
					0 204 032 601	

	1.5	07.92-10.93	52	BSY	0 204 032 347	
	1.5 MPI	09.97-06.02	56		0 204 032 359	
	1.6 MPI	10.95-10.96	66	BSY	0 204 032 359	
					0 204 032 926	

	1.5	12.88-10.93	52		1987 477 296	2828
	1.5 MPI	09.97-06.02	56		1987 477 989	3105
	1.6	05.91-10.94	66		1987 477 296	2828
	1.6 MPI	10.95-10.96	66		1987 477 989	3105

	1.5 MPI	09.97-06.02	56	CSA,LAB	0 265 006 539⁴	
				LAB	0 265 006 538³	
				RAB	0 265 006 537³	
					0 265 006 540⁴	

Fiorino Qubo [300..]

	1.3 MJTD	09.08→	55		1987 476 451	425
	1.4 i.e.					

	1.3 MJTD	09.08→	55		0 204 004 564	← 54
	1.4 i.e.				0 204 004 565	→ 54

	1.3 MJTD	09.08→	55		0986 475 936	↔ 20,64
	1.4 i.e.					

	1.3 MJTD	09.08→	55	LLE	0 204 123 767	22,19
				RLE	0 204 123 685	22,19
	1.4 i.e.	09.08→	55	LLE	0 204 123 767	22,19
		ESP 09.08→	55	RLE	0 204 123 686	22,19
		OFD 09.08→	55	RLE	0 204 123 685	22,19

		S							
	1.3 MJTD	09.08→	55			LLE	0 204 125 900		
	1.4 i.e.					RLE	0 204 125 852		
	1.3 MJTD	09.08→	55			RLE	0 986 486 556		
	1.3 MJTD	09.08→	55				1 987 482 207	→ 1650	
							1 987 482 208	← 1584	
	1.4 i.e.	09.08→	55				1 987 482 205	→ 1604	
							1 987 482 206	← 1555	
	1.3 MJTD	09.08→	55				0 265 005 607		
Fiorino [225..]									
	1.3 MJTD	12.07→	55				1 987 476 451	425	
	1.4 i.e.								
	1.3 MJTD	12.07→	55				0 204 004 564	← 54	
	1.4 i.e.						0 204 004 565	→ 54	
	1.3 MJTD	12.07→	55				0 986 475 936	↔ 20,64	
	1.4 i.e.								
	1.3 MJTD	12.07→	55			LLE	0 204 123 767	22,19	
						RLE	0 204 123 685	22,19	
	1.4 i.e.	12.07→	55			LLE	0 204 123 767	22,19	
		ESP 12.07→	55			RLE	0 204 123 686	22,19	
		OFD 12.07→	55			RLE	0 204 123 685	22,19	
	1.3 MJTD	12.07→	55			LLE	0 204 125 900		
	1.4 i.e.					RLE	0 204 125 852		
	1.3 MJTD	12.07→	55			RLE	0 986 486 556		
	1.3 MJTD	12.07→	55				1 987 482 207	→ 1650	
							1 987 482 208	← 1584	
	1.4 i.e.	12.07→	55				1 987 482 205	→ 1604	
							1 987 482 206	← 1555	
	1.3 MJTD	12.07→	55				0 265 005 607		





Fiorino [255..]



	1.1	01.88-08.93	40	Fg.Nr. →VET8174365	1987 476 881	384
	1.3	01.88-08.93	49	Fg.Nr. →VET8174365	1987 476 881	384
		09.93-12.01	49		1987 481 190	385
	1.3D	01.88-08.93	33		1987 476 881	384
	1.4 i.e.	06.95-12.01	49		1987 481 190	385
		ABS 09.93-06.95	52		1987 481 190	385
	1.5 i.e.	01.88-08.93	55	Fg.Nr. →VET8174365	1987 476 881	384
	1.6 i.e.	06.95-12.01	59		1987 481 190	385
		ABS 09.93-06.95	59		1987 481 190	385
	1.7D	01.88-08.93	42		1987 476 881	384
			43		1987 476 881	384
	1.7 TDS	ABS 09.93-12.01	43		1987 481 190	385
	ABS 02.97-12.01	46		1987 481 190	385	



	1.1	01.88-08.93	40		1987 476 954¹	255
	1.3	01.88-08.93	49		1987 476 954¹	255
		ABO 09.93-12.01	49		ZE 1987 481 118¹	394
	1.3D	01.88-08.93	33		1987 476 954¹	255
	1.4 i.e.	ABO 09.93-12.01	49/52		ZE 1987 481 118¹	394
	1.5 i.e.	01.88-08.93	55		1987 476 954¹	255
	1.6 i.e.	ABO 09.93-12.01	59		ZE 1987 481 118¹	394
	1.7D	01.88-08.93	42		1987 476 954¹	255
			43		1987 476 954¹	255
		ABO 09.93-12.01	43		ZE 1987 481 118¹	394
	1.7 TDS	ABO 02.97-12.01	46		ZE 1987 481 118¹	394





















	1.1	01.88-08.93	40		F 026 002 454	↔ 19,05
	1.3	01.88-08.93	49		F 026 002 454	↔ 19,05
		09.93-12.01	49		BSY 0986 475 867	↔ 20,64
	1.3D	01.88-08.93	33		F 026 002 454	↔ 19,05
	1.4 i.e.	09.93-12.01	49/52		BSY 0986 475 867	↔ 20,64
	1.5 i.e.	01.88-08.93	55		F 026 002 454	↔ 19,05
	1.6 i.e.	09.93-12.01	59		BSY 0986 475 867	↔ 20,64
	1.7D	01.88-08.93	42		F 026 002 454	↔ 19,05
			43		F 026 002 454	↔ 19,05
		09.93-12.01	43		BSY 0986 475 867	↔ 20,64
	1.7 TDS	02.97-12.01	46		BSY 0986 475 867	↔ 20,64



	1.1	01.88-08.93	40		ATE 0986 480 656	20,6
	1.3	01.88-08.93	49		ATE 0986 480 656	20,6
		ABO 09.93-12.01	49		BSY 0204 032 301	22,21
	1.3D	01.88-08.93	33		ATE 0986 480 656	20,6
	1.4 i.e.	ABO 09.93-12.01	49/52		BSY 0204 032 301	22,21
	1.5 i.e.	01.88-08.93	55		ATE 0986 480 656	20,6
	1.6 i.e.	ABO 09.93-12.01	59		BSY 0204 032 301	22,21
	1.7D	01.88-12.90	43		ATE 0986 480 656	20,6
		01.88-08.93	42		ATE 0986 480 656	20,6
		ABO 09.93-12.01	43		BSY 0204 032 301	22,21
	1.7 TDS	ABO 02.97-12.01	46		BSY 0204 032 301	22,21

	1.1	01.88-08.93	40		BSY 0204 032 347	
	1.3	01.88-08.93	49		BSY 0204 032 347	
		ABO 09.93-12.01	49		0204 032 359	
1.3D	01.88-08.93	33		BSY 0204 032 347		

		S							
1.4 i.e.		ABO	09.93-12.01	49/52			0 204 032 359		
1.5 i.e.			01.88-08.93	55		BSY	0 204 032 347		
1.6 i.e.		ABO	09.93-12.01	59			0 204 032 359		
1.7 D			01.88-08.93	42		BSY	0 204 032 347		
				43		BSY	0 204 032 347		
		ABO	09.93-12.01	43		BSY	0 204 032 926		
1.7 TDS		ABO	02.97-12.01	46		BSY	0 204 032 926		
 1.1			01.88-08.93	40	Ricam.Nr →VET8174365		0 204 131 223		
1.3			01.88-08.93	49	Ricam.Nr →VET8174365		0 204 131 223		
			09.93-12.01	49		BSY	0 204 131 202 ¹⁰		
1.3 D			01.88-08.93	33			0 204 131 223 ¹⁰		
1.4 i.e.			09.93-12.01	49/52		BSY	0 204 131 202 ¹⁰		
1.5 i.e.			01.88-08.93	55	Ricam.Nr →VET8174365		0 204 131 223		
1.6 i.e.			09.93-12.01	59		BSY	0 204 131 202 ¹⁰		
1.7 D			01.88-08.93	42			0 204 131 223 ¹⁰		
				43			0 204 131 223 ¹⁰		
			09.93-12.01	43		BSY	0 204 131 202 ¹⁰		
1.7 TDS			02.97-12.01	46		BSY	0 204 131 202 ¹⁰		
 1.1			01.88-08.93	40			1 987 477 296	2828	
1.3			01.88-08.93	49			1 987 477 296	2828	
			09.93-12.01	49			1 987 477 989	3105	
1.3 D			01.88-08.93	33			1 987 477 296	2828	
1.4 i.e.			09.93-12.01	49/52			1 987 477 989	3105	
1.5 i.e.			01.88-08.93	55			1 987 477 296	2828	
1.6 i.e.			09.93-12.01	59			1 987 477 989	3105	
1.7 D			01.88-08.93	42			1 987 477 296	2828	
				43			1 987 477 296	2828	
			09.93-12.01	43			1 987 477 989	3105	
1.7 TDS			02.97-12.01	46			1 987 477 989	3105	
 1.4 i.e.			09.93-06.95	52/59			1 273 004 290 ¹⁶		
1.6 i.e.									
 1.3			09.93-12.01	43/46/49/	CSA, LAB		0 265 006 539 ⁴		
1.4 i.e.				52/59	LAB		0 265 006 538 ³		
1.6 i.e.					RAB		0 265 006 537 ³		
1.7 D, TDS							0 265 006 540 ⁴		
Panda Van [241..]									
									
 1000 ACT			10.87-05.91	33			1 987 476 239	280	
 1000 ACT			10.87-05.91	33			0 204 102 447	← 48	0 204 104 184
							0 986 473 104		
							0 204 102 448	→ 48	0 204 104 184
							0 986 474 104		
									
 1000 ACT			10.87-05.91	33			1 987 476 416 ¹	185	





◀ FIAT Panda Van [241..]

	1000 ACT	10.87-05.91	33		F 026 002 454	↔ 19,05
	1000 ACT	10.87-05.91	33	LLE	F 026 003 226	19,05
				RLE	0 204 122 237	19,05
	1000 ACT	10.87-05.91	33		1 987 477 331	1300

Scudo [222..]

	1.6 i	10.95-05.04	51/52/58		1 987 476 951	470
	1.9D					
	1.9D	ABS 06.04-01.07	51		1 987 476 951	470
	1.9 TD	10.95-05.00	66/68/70/81		1 987 476 951	470
	2.0 16V	05.00-05.04	81/100		1 987 476 951	470
	2.0 16V JTD	ABS 06.04-01.07	81/100		1 987 476 951	470
	2.0 8V JTD	10.99-05.04	66/68/70/81		1 987 476 951	470
		ABS 06.04-01.07	70/81		1 987 476 951	470
	1.6 i	10.95-05.00	58	BSY	0 204 102 521	← 57 0 204 100 316 ⁸
					0 204 103 521	→ 57 0 204 104 177 ⁷
					0 204 102 523	→ 57 0 204 100 316 ⁸
					0 204 103 523	→ 57 0 204 100 316 ⁸
				LUC	0 986 473 115	← 57,1
					0 986 474 115	→ 57,1
	1.9D	10.95-08.01	51	BSY	0 204 102 521	← 57 0 204 100 316 ⁸
					0 204 103 521	→ 57 0 204 104 177 ⁷
					0 204 102 523	→ 57 0 204 100 316 ⁸
					0 204 103 523	→ 57 0 204 100 316 ⁸
				LUC	0 986 473 115	← 57,1
					0 986 474 115	→ 57,1
		09.01-05.04	52	BSY	0 204 102 521	← 57 0 204 100 316 ⁸
					0 204 103 521	→ 57 0 204 104 177 ⁷
					0 204 102 523	→ 57 0 204 100 316 ⁸
					0 204 103 523	→ 57 0 204 100 316 ⁸
				LUC	0 986 473 115	← 57,1
					0 986 474 115	→ 57,1
		06.04-01.07	51	BSY	0 204 102 521	← 57 0 204 104 177 ⁷
					0 204 103 521	→ 57 0 204 104 177 ⁷
					0 204 102 523	→ 57 0 204 104 177 ⁷
					0 204 103 523	→ 57 0 204 104 177 ⁷
	1.9 TD	10.95-05.00	66/68	BSY	0 204 102 521	← 57 0 204 100 316 ⁸
					0 204 103 521	→ 57 0 204 104 177 ⁷
					0 204 102 523	→ 57 0 204 100 316 ⁸
					0 204 103 523	→ 57 0 204 100 316 ⁸
				LUC	0 986 473 115	← 57,1
					0 986 474 115	→ 57,1

		S											
2.0 16V 2.0 16V JTD 2.0 8V JTD		10.99-05.04	70/81/100			BSY	0 204 102 521	← 57	0 204 100 316 ⁸				
							0 204 103 521						
							0 204 102 523	→ 57	0 204 100 316 ⁸				
							0 204 103 523						
							LUC	0 986 473 115	← 57,1				
								0 986 474 115	→ 57,1				
		10.99-01.07	70/81/100			BSY	0 204 102 521	← 57	0 204 104 177 ⁷				
		06.04-01.07	70/81/100			BSY	0 204 103 521						
							0 204 102 523	→ 57	0 204 104 177 ⁷				
							0 204 103 523						
<hr/>													
	1.6 i 1.9 D, TD 2.0 16V, 16V JTD, 8V JTD	10.95-01.07	51/52/58/ 66/68/70/ 81/100				1 987 476 947 ¹	250					
	1.6 i 1.9 D, TD 2.0 16V, 16V JTD, 8V JTD	10.95-01.07	51/52/58/ 66/68/70/ 81/100				F 026 002 181	↔ 19,05					
<hr/>													
	1.6 i	ABO	10.95-05.99	51/58	Ricam.Nr →8211	RLE	F 026 003 166	23,8					
			ABS	10.95-05.99	51/58	Ricam.Nr →8211	LLE	F 026 003 518	22,19				
		1.9 D	ABO	10.95-05.99	51/58	Ricam.Nr →8211	RLE	F 026 003 166	23,8				
				ABS	10.95-05.99	51/58	Ricam.Nr →8211	LLE	F 026 003 518	22,19			
		1.9 TD	ABO	10.95-05.99	68	Ricam.Nr →8211		F 026 003 166	23,8				
				03.97-05.99	66	Ricam.Nr →8211	RLE	F 026 003 166	23,8				
				ABS	10.95-05.99	68	Ricam.Nr →8211		0 204 123 182	23,8			
			03.97-05.99	66	Ricam.Nr →8211	L01,LLE	F 026 003 518	22,19					
						LLE	F 026 003 518	22,19					
						RLE	0 204 123 182	23,8					
			1.9 D 1.9 TD 2.0 16V, 16V JTD 2.0 8V JTD	06.98-01.07	51/52			L09,LLE	0 204 125 715				
								10.95-05.00	68		F0G,L09, LLE	0 204 125 715	
05.00-01.07	81/100							LLE	0 204 125 715				
								10.99-05.04	81		LLE	0 204 125 715	
								10.99-01.07	70		F0G,LLE	0 204 125 715	
								06.04-01.07	81		F0G,LLE	0 204 125 715	
<hr/>													
	1.6 i 1.9 D, TD 2.0 16V, 16V JTD, 8V JTD	10.95-01.07	51/52/58/ 66/68/70/ 81/100				FKR	1 987 477 565	500				
							FLR	1 987 477 774	900				
							LLE	1 987 477 569	→ 2286				
<hr/>													
	1.6 i 1.9 D, TD 2.0 8V JTD	06.97-12.99	51/58/66/ 68/70/81	Ricam.Nr 7480→8420			0 265 216 496 ¹¹						
	1.6 i 1.9 D 1.9 TD 2.0 16V, 16V JTD, 8V JTD	05.97-09.97	51/58/66/ 68	Ricam.Nr 7480→7608			0 265 006 426 ⁴						
							06.97-08.01	51/58/66/ 68	Ricam.Nr 7480→9050			0 265 006 388 ³	
		09.97-08.01	51/58/66/ 68	Ricam.Nr 7609→9050		0 265 006 504 ⁴							
													10.99-08.01
					Ricam.Nr 7609→9050		0 265 006 504 ⁴						





Scudo [272..]

	1.6 D Multijet	01.07→	66	FKR,SBR	1987 482 007	1614	
				FLR,SBR	1987 482 008	1737	
				TBR	1987 482 118	1718	
	2.0 D Multijet	01.07→	88/103	FKR	1987 482 007	1614	
	2.0 D Multijet FAP			FLR	1987 482 008	1737	
	1.6 D Multijet	12.07-06.08	66/88/103	Ricam.Nr →11557	0265 005 724		
	2.0 D Multijet	07.08-11.08	66/88/103	Ricam.Nr 11558→11683	0265 005 765		
		12.08→	66/88/103	Ricam.Nr 11684→	0265 005 765		
	2.0 D Multijet FAP	10.08-11.08	88	Ricam.Nr 11558→11683	0265 005 765		
		12.08→	88	Ricam.Nr 11684→	0265 005 765		

Strada

	1.3 MPI 8V	ABS	09.02-05.05	49		1987 476 879	504
	1.5 MPI 8V		10.98-09.00	56		1987 476 879	504
	1.6 MPI 16V		02.98-02.03	78		1987 476 879	504
	1.5 MPI 8V		10.98-01.02	56		0986 473 125	← 54
						0986 474 125	→ 54
	1.6 MPI 16V		02.98-04.99	78		0986 473 125	← 54
						0986 474 125	→ 54
	1.3 MPI 8V		10.98-05.05	49/52/56		0204 032 601	
	1.5 MPI 8V	ABO	10.98-05.05	49/52/56	BSY	0204 032 301	22,21
	1.7 D Turbo						
	1.3 MPI 8V	ABO	10.98-05.05	49/52/56	BSY	0204 032 385	
	1.5 MPI 8V						
	1.7 D Turbo						
	1.3 MPI 8V		02.98-05.05	49/52/56/		1987 477 829	→ 1710
	1.5 MPI 8V			78		1987 477 830	← 1710
	1.6 MPI 16V						
	1.7 D Turbo						
	1.3 MPI 8V		09.02-05.05	49		0265 216 828 ¹	
	1.5 MPI 8V		10.98-02.03	56		0265 216 572 ¹	
	1.6 MPI 16V		02.98-09.00	78		0265 216 572 ¹	
			10.00-02.03	78		0265 216 828 ¹	
	1.7 D Turbo		01.04-12.04	52		0265 216 828 ¹	
	1.3 MPI 8V		02.98-05.05	49/56/78	LAB	0265 007 049 ³	
	1.5 MPI 8V					0265 007 054 ⁴	
	1.6 MPI 16V				RAB	0265 007 050 ³	
						0265 007 055 ⁴	
	1.7 D Turbo		01.04-12.04	52	LAB	0265 007 054 ⁴	
						0265 007 103 ³	
					RAB	0265 007 055 ⁴	
					0265 007 102 ³		





Strada Adventure [Fase II]

	1.7 TD	10.06-12.08	52			0 986 473 125 ← 54 0 986 474 125 → 54
	1.7 TD	10.06-12.08	52			0 204 032 601
		ABO 10.06-12.08	52		BSY	0 204 032 301 22,21
	1.7 TD	ABO 10.06-12.08	52		BSY	0 204 032 385
	1.7 TD	10.06-12.08	52			0 204 131 202 ¹⁰
	1.7 TD	10.06-12.08	52			1 987 477 829 → 1710 1 987 477 830 ← 1710
	1.7 TD	10.06-12.08	52			0 265 216 828 ¹¹
	1.7 TD	10.06-12.08	52		LAB	0 265 007 054 ⁴
						0 265 007 103 ³
					RAB	0 265 007 055 ⁴
						0 265 007 102 ³

Strada [Fase II]

	1.7 D Turbo	01.05-12.08	52			0 986 473 125 ← 54 0 986 474 125 → 54
	1.7 D Turbo	01.05-12.08	52			0 204 032 601
		ABO 01.05-12.08	52		BSY	0 204 032 301 22,21
	1.7 D Turbo	ABO 01.05-12.08	52		BSY	0 204 032 385
	1.7 D Turbo	01.05-12.08	52			1 987 477 829 → 1710 1 987 477 830 ← 1710
	1.7 D Turbo	01.05-12.08	52			0 265 216 828 ¹¹





FIAT Strada [Fase II]

	1.7 D Turbo	01.05-12.08	52	LAB	0 265 007 054 ⁴		
					0 265 007 103 ³		
					RAB	0 265 007 055 ⁴	
					0 265 007 102 ³		

Strada [278]



	1.2 MPI 8V	03.99-04.03	44/46/51/		1987 476 879	504
	1.7 TDS		54			
	1.9 D					

	1.2 MPI 8V	03.99→	44/46/51/	MIH	0986 473 125	← 54
	1.3 JTD		54/59/63		0986 474 125	→ 54
	1.7 TDS					
	1.9 D, JTD					



	1.2 MPI 8V	ABS 04.03→	46/54/59/		1987 476 879 ²	504
	1.3 JTD		63			
	1.9 D, JTD					



	1.2 MPI 8V	03.99-03.05	44			0 204 032 601	
		05.01-03.03	54			0 204 032 601	
		07.05→	54			0 204 123 524	22,21
		ABO 03.99-04.03	44		ATN BSY	0 204 032 301	22,21
		03.99-03.05	44		ATJ BSY	F 026 003 671	22,19
		05.01-03.03	54		BSY	0 204 032 301	22,21
		1.3 JTD	07.05→	63		0 204 032 601	
		ABO 07.05→	63		BSY	0 204 032 301	22,21
		1.7 TDS	03.99-03.03	46/51		0 204 032 601	
		1.9 D	ABO 03.99-03.03	46/51		BSY	0 204 032 301

	1.2 MPI 8V	07.05→	54			0 204 125 728	
		ABO 03.99-04.03	44	Fg.Nr. 2724992→	ATN BSY	0 204 032 385	
		03.99-03.05	44		ATJ BSY	0 204 125 807	
		05.01-03.03	54	Fg.Nr. 2724992→	BSY	0 204 032 385	
		1.3 JTD	ABO 07.05→	63		BSY	0 204 032 385
1.7 TDS	ABO 03.99-03.03	46/51	Fg.Nr. 2724992→	BSY	0 204 032 385		
1.9 D							

	1.2 MPI 8V	07.05→	54			F 009 D00 769	
--	------------	--------	----	--	--	---------------	--

	1.3 JTD	07.05→	63			0986 486 556	
--	---------	--------	----	--	--	--------------	--

	1.2 MPI 8V	07.05→	54			0 204 131 202 ¹⁰	
	1.2 MPI 8V	ABO 03.99→	44/46/51/			0 204 131 202 ¹⁰	
	1.3 JTD		54/59/63				
	1.7 TDS						
1.9 D, JTD							



	1.2 MPI 8V	03.99→	44/46/51/		1 987 477 829	→ 1710
	1.3 JTD		54/59/63		1 987 477 830	← 1710
	1.7 TDS					
	1.9 D, JTD					

	1.2 MPI 8V	03.99-04.03	44		0 265 216 572 ¹¹	
		05.01-03.03	54		0 265 216 572 ¹¹	
		04.03-06.05	54		0 265 216 828 ¹¹	
	1.3 JTD	07.05→	63		0 265 216 828 ¹¹	
	1.7 TDS	03.99-03.03	51		0 265 216 572 ¹¹	
	1.9 D	11.00-03.03	46		0 265 216 572 ¹¹	
		04.03-06.05	46		0 265 216 828 ¹¹	
1.9 JTD	04.03-06.05	59		0 265 216 828 ¹¹		

	1.2 MPI 8V	03.99-03.05	44		LAB	0 265 007 049 ³		
						0 265 007 054 ⁴		
					RAB	0 265 007 050 ³		
			05.01-03.03	54		LAB	0 265 007 049 ³	
						RAB	0 265 007 050 ³	
			05.01-06.05	54		LAB	0 265 007 054 ⁴	
						RAB	0 265 007 054 ⁴	
			04.03-06.05	54		ATJ,LAB	0 265 007 103 ³	
						ATJ,RAB	0 265 007 102 ³	
						ATN,LAB	0 265 007 049 ³	
						ATN,RAB	0 265 007 050 ³	
	1.3 JTD	07.05→	63			LAB	0 265 007 054 ⁴	
							0 265 007 103 ³	
						RAB	0 265 007 054 ⁴	
							0 265 007 102 ³	
1.7 TDS	03.99-06.05	46/51/59			LAB	0 265 007 049 ³		
						0 265 007 054 ⁴		
1.9 D						0 265 007 050 ³		
1.9 JTD					RAB	0 265 007 050 ³		
						0 265 007 054 ⁴		

Talento



	1.9 D	03.88-02.94	51/55		OE,ZE	1 987 476 462	435
	2.0				UE,ZE	1 987 476 463	435

	1.9 D	03.88-02.94	51/55			0 986 473 776	← 38
	2.0					0 986 473 777	→ 38



	1.9 D	03.88-12.94	51/55			0 986 475 056	↔ 22,19
	2.0						



	1.9 D	08.89-12.94	51/55	Fg.Nr. →0273004,		F 026 003 150	22,19
	2.0			→0169505			
				Fg.Nr. 0273005→,		F 026 003 194	22,19
				0169506→			





◀ FIAT Talento

	1.9D	09.89-12.94	51/55	Fg.Nr. →0169505	LLE	BSY	0 204 125 417		
	2.0			Fg.Nr. →0273004, →0169505			0 204 125 416 ²⁵		
				Fg.Nr. 0273005→, 0169506→			0 204 125 420 ²⁵		
							0 204 125 423		

	1.9D	03.88-12.94	51/55				0 204 031 056 ¹⁰		
	2.0								

Uno Furgoneta



	1.5 MPI 8V	04.97-12.00	56				1 987 481 190	385	



	1.5 MPI 8V	04.97-12.00	56				1 987 476 954	255	

	1.5 MPI 8V	04.97-12.00	56		ATE	F 026	002 454	↔ 19,05	



	1.5 MPI 8V	04.97-12.00	56		ATE	0 986	480 656	20,6	

	1.5 MPI 8V	04.97-12.00	56				0 204 032 347		

Uno Van [246..]























	0.9	09.89-03.94	33				1 987 476 413	410	
	1.0, i.e.								
	1.7D	01.91-03.94	42				1 987 476 445	435	

	0.9	09.89-03.94	33		MIH	0 204 102 447	← 48	0 204 104 184
	1.0					0 986 473 104	↻	
	1.0 i.e.					0 204 102 448	→ 48	0 204 104 184
						0 986 474 104	↻	
	1.7D	01.91-03.94	42		MIH	0 204 102 524	← 48	
						0 204 102 547	→ 48	
					MIH	0 204 102 524	← 48	0 204 104 234 ⁷
						0 204 103 524	↻	
						0 204 102 525	→ 48	0 204 104 234 ⁷
						0 204 103 525	↻	



	0.9	09.89-03.94	33/42				1 987 476 006 ¹	200	
	1.0, i.e.								
	1.7D								

		S							
	0.9 1.0, i.e. 1.7D	09.89-03.94	33/42				F 026 002 454	↔ 19,05	
									
	0.9 1.0, i.e. 1.7D	09.89-03.94	33/42		LLE		F 026 003 296	20,6	
	1.0 1.0 i.e. 1.7D	09.89-03.94	33		LLE		0 204 125 351		
		01.91-03.94	42		LLE		0 204 125 360		
	1.0 1.0 i.e.	09.89-03.94	33		RLE		0 204 162 081		
	1.0 1.0 i.e.	04.92-09.92	33		RLE		F 026 005 580		
		09.89-03.94	33	Ricam.Nr →0984009, →9307923	RLE		F 026 005 580		
				Ricam.Nr →1696083, →4528492	RLE		F 026 005 580		
				Ricam.Nr →9307260	RLE		F 026 005 580		
	0.9 1.0, i.e. 1.7D	09.89-03.94	33/42				0 204 131 223 ¹⁰		
	0.9 1.0 1.0 i.e. 1.7D	09.89-03.94	33/42	Ricam.Nr →7767870, →7466388			1 987 477 091	← 520	
				Ricam.Nr 7767871→, 7466389→			1 987 477 289	→ 2015	
							1 987 477 377	→ 2016	
							1 987 482 108	← 1776	
FORD									
Courier									
									
	1.3i 1.4i16V	07.97-08.99	44/66				0 204 032 828		
F									
									
	250	10.98→	107/132/ 149/150				0 204 032 819		
							0 204 032 820		
					STB		0 204 032 594		
					4SB		0 204 0A2 169		
							0 204 032 611		
	350	11.98-08.05	104				0 204 032 594		
							0 204 032 819		
	1000	03.95-10.98	150				0 204 032 307		





P 100

	1.8 L TD 2.0 L	01.88-12.92	55/57		0986 473 912 CSA 0986 473 911	54 54	1987 470 506 ⁸

	1.8 L TD 2.0 L	01.88-12.92	55/57		0986 475 703 0986 475 704	23,8 23,8	

	1.8 L TD 2.0 L	01.88-12.92	55/57		RLE 0204 123 471	23,8	

	1.8 L TD 2.0 L	01.88-12.92	55/57		BSY 0204 125 064		

Ranger























	2.3 i 2.3 i 16V XLS 3.0 D Eletronic 4.0 i	06.94-10.97 03.01-06.09 01.05-06.09 01.95-10.97 11.97-12.02	100 100 120 119 119		GES GES GES	0204 032 824 0204 022 753 0204 022 753 0204 032 824 0204 022 753	

	2.3 i 16V XLS 2.5 D, i 3.0 D Eletronic 4.0 i	10.97-06.09	85/89/100/ 119/120			0204 022 747	

Transit

	FT 280 S 2.4 TDI FT 300 S 2.0 TDCi FT 300 S 2.4 TDI FT 310 S 2.4 TDI FT 330 L 2.4 TDI FT 330 M 2.4 TDI FT 330 S 2.4 TDI FT 350 E 2.4 TDI FT 350 L 2.4 TDI FT 350 M 2.4 TDI FT 430 E 2.4 TDI	01.01-05.06 05.02-05.06 01.01-05.06 01.01-05.06 66/74/88/ 96 66/74/88/ 96	66 92 66/74/88/ 96			1987 481 045 1987 481 070 1987 481 046 1987 481 047 1987 481 045 1987 481 070 1987 481 045 1987 481 070	475 475 478 410 410 410 475 475 478 475 475 478	



		S							
	FT 260 2.2 TDCi	04.06→	63/81/85/				0 204 004 617	← 48	
	FT 280 2.2 TDCi		96/103				0 204 004 618	→	
	FT 280 S 2.4 TDI	01.01-05.06	66				0 204 204 992	← 48	0 204 201 289 ^B
							0 986 473 272		0 204 201 476
							0 204 204 993	→ 48	0 204 201 289 ^B
							0 986 474 272		
	FT 300 S 2.0 TDCi	01.01-05.06	66/74/88/				0 204 204 992	← 48	0 204 201 289 ^B
	FT 300 S 2.4 TDI		92				0 986 473 272		0 204 201 476
	FT 310 S 2.4 TDI						0 204 204 993	→ 48	0 204 201 289 ^B
							0 986 474 272		
	FT 300 2.2 TDCi	04.06→	63/81/85/				0 204 004 617	← 48	
			96/103				0 204 004 618	→	
	FT 300 2.4 TDCi	07.06→	74				0 204 004 615	← 48	0 204 104 261 ^B
							0 204 004 616	→ 48	0 204 104 261 ^B
	FT 330 L 2.4 TDI	01.01-05.06	66/74/88				0 204 204 992	← 48	0 204 201 289 ^B
	FT 330 M 2.4 TDI						0 986 473 272		0 204 201 476
	FT 330 S 2.4 TDI						0 204 204 993	→ 48	0 204 201 289 ^B
							0 986 474 272		
	FT 330 2.2 TDCi, 2.3i, 2.3i CNG	04.06→	74/81/85/				0 204 004 615	← 48	0 204 104 261 ^B
	FT 330 2.3i LPG, 2.4 TDCi		96/100-107				0 204 004 616	→ 48	0 204 104 261 ^B
	FT 330 2.4 TDCi 4x4								
	FT 350 E 2.4 TDI	01.01-05.06	66/88/96				0 204 204 992	← 48	0 204 201 289 ^B
	FT 350 L 2.4 TDI						0 986 473 272		0 204 201 476
	FT 350 M 2.4 TDI						0 204 204 993	→ 48	0 204 201 289 ^B
							0 986 474 272		
	FT 350 2.2 TDCi, 2.3i, 2.3i CNG	04.06→	74/81/85/				0 204 004 615	← 48	0 204 104 261 ^B
	FT 350 2.3i LPG, 2.4 TDCi		96/100-107/147				0 204 004 616	→ 48	0 204 104 261 ^B
	FT 350 2.4 TDCi 4x4, 3.2 TDCi								
	FT 430 E 2.4 TDI	06.04-05.06	96				0 204 204 992	← 48	0 204 201 289 ^B
							0 986 473 272		0 204 201 476
							0 204 204 993	→ 48	0 204 201 289 ^B
							0 986 474 272		
	FT 430 2.4 TDCi	07.06→	74/85/103				0 204 004 615	← 48	0 204 104 261 ^B
	FT 430 2.4 TDCi 4x4						0 204 004 616	→ 48	0 204 104 261 ^B
	FT 460 2.4 TDCi, 2.4 TDCi 4x4	07.06→	103/147				0 204 004 615	← 48	0 204 104 261 ^B
	FT 460 3.2 TDCi						0 204 004 616	→ 48	0 204 104 261 ^B
	2.8	12.97→	68		14Z		0 204 102 925	→ 42	0 204 100 277 ^B
							0 204 103 925		0 204 104 135 ⁷
							0 204 102 926	← 42	0 204 100 277 ^B
							0 204 103 926		
					6LO		0 204 102 934	→ 42	0 204 104 135 ⁷
							0 204 102 935	← 42	0 204 104 135 ⁷
	FT 280 S 2.4 TDI	01.01-05.06	66/74/88/			BUS,KOB,KW	1 987 481 072 ¹	375	
	FT 300 S 2.0 TDCi, 2.4 TDI		92/96			FGS,PW	1 987 481 073 ¹	425	
	FT 310 S 2.4 TDI								
	FT 330 L 2.4 TDI								
	FT 330 M 2.4 TDI								
	FT 330 S 2.4 TDI								
	FT 350 E 2.4 TDI								
	FT 350 L 2.4 TDI								
	FT 350 M 2.4 TDI								
	FT 430 E 2.4 TDI								















◀ FORD Transit

	FT 260 2.2 TDCi	01.01→	63/66/74/	F 026 002 578	↔ 25,4
	FT 280 S 2.4 TDI		81/85/88/		
	FT 280 2.2 TDCi		92/96/103		
	FT 300 S 2.0 TDCi, 2.4 TDI				
	FT 300 2.2 TDCi, 2.4 TDCi				
	FT 310 S 2.4 TDI				
	FT 330 L 2.4 TDI				
	FT 330 M 2.4 TDI				
	FT 330 S 2.4 TDI				
	FT 330 2.2 TDCi				
	FT 350 E 2.4 TDI				
	FT 350 L 2.4 TDI				
	FT 350 M 2.4 TDI				
FT 430 E 2.4 TDI					

	FT 260 2.2 TDCi	04.06→	63/74/81/	0 204 902 026	← 48
	FT 280 2.2 TDCi		85/96/	0 204 902 027	→ 48
	FT 300 2.2 TDCi, 2.4 TDCi		100-107/147		
	FT 330 2.2 TDCi, 2.3i, 2.3i CNG				
	FT 330 2.3i LPG, 2.4 TDCi				
	FT 330 2.4 TDCi 4x4				
	FT 350 2.2 TDCi, 2.3i, 2.3i CNG				
	FT 350 2.3i LPG, 2.4 TDCi				
	FT 350 2.4 TDCi 4x4, 3.2 TDCi				
	FT 430 2.4 TDCi, 2.4 TDCi 4x4				











	FT 260 2.2 TDCi	ABO 04.06→	63/81/85/96/103	0 204 123 717	25,4
	FT 280 2.2 TDCi	ABS 04.06→	63/81/85/96/103	0 204 123 716	25,4
	FT 280 S 2.4 TDI	ABO 01.01-05.06	66	0 204 024 070	25,4
		ABS 01.01-05.06	66	0 204 024 071	25,4
	FT 300 S 2.0 TDCi	ABO 05.02-05.06	92	0 204 024 070	25,4
		ABS 05.02-05.06	92	0 204 024 071	25,4
	FT 300 S 2.4 TDI	ABO 01.01-05.06	66/74	0 204 024 070	25,4
		ABS 01.01-05.06	66/74	0 204 024 071	25,4
	FT 300 2.2 TDCi	ABO 04.06→	63/81/85/96/103	0 204 123 717	25,4
		ABS 04.06→	63/81/85/96/103	0 204 123 716	25,4
	FT 300 2.4 TDCi	ABO 07.06→	74	0 204 123 717	25,4
		ABS 07.06→	74	0 204 123 716	25,4
	FT 310 S 2.4 TDI	ABO 01.01-05.06	88	0 204 024 070	25,4
		ABS 01.01-05.06	88	0 204 024 071	25,4
	FT 330 L 2.4 TDI	ABO 01.01-05.06	66/88	0 204 024 070	25,4
	FT 330 M 2.4 TDI	ABS 01.01-05.06	66/88	0 204 024 071	25,4
	FT 330 S 2.4 TDI	ABO 01.01-05.06	66/74/88	0 204 024 070	25,4
		ABS 01.01-05.06	66/74/88	0 204 024 071	25,4
	FT 330 2.2 TDCi	ABO 04.06→	81/85/96/103	0 204 123 717	25,4
		ABS 04.06→	81/85/96/103	0 204 123 716	25,4
	FT 330 2.3i, 2.3i CNG	ABO 04.06→	100-107	0 204 123 717	25,4
	FT 330 2.3i LPG	ABS 04.06→	100-107	0 204 123 716	25,4
	FT 330 2.4 TDCi	ABO 07.06→	74/85/103	0 204 123 717	25,4
		ABS 07.06→	74/85	0 204 123 716	25,4
	FT 330 2.4 TDCi, 2.4 TDCi 4x4	ABS 07.06→	103	0 204 123 716	25,4
	FT 330 2.4 TDCi 4x4	ABO 09.07→	103	0 204 123 717	25,4
	FT 350 E 2.4 TDI	ABO 01.01-05.06	66/88/96	0 204 024 070	25,4
	FT 350 L 2.4 TDI	ABS 01.01-05.06	66/88/96	0 204 024 071	25,4
	FT 350 M 2.4 TDI				
	FT 350 2.2 TDCi	ABO 04.06→	81/85/96/103	0 204 123 717	25,4
		ABS 04.06→	81/85/96/103	0 204 123 716	25,4
	FT 350 2.3i, 2.3i CNG	ABO 04.06→	100-107	0 204 123 717	25,4
FT 350 2.3i LPG	ABS 04.06→	100-107	0 204 123 716	25,4	

									
FT 350 2.4 TDCi	ABO	07.06→	74/85/103				0 204 123 717	25,4	
	ABS	07.06→	74/85				0 204 123 716	25,4	
FT 350 2.4 TDCi, 2.4 TDCi 4x4	ABS	07.06→	103				0 204 123 716	25,4	
FT 350 2.4 TDCi 4x4	ABO	09.07→	103				0 204 123 717	25,4	
FT 350 3.2 TDCi	ABO	08.07→	147				0 204 123 717	25,4	
	ABS	08.07→	147				0 204 123 716	25,4	
FT 430 E 2.4 TDI	ABO	06.04-05.06	96				0 204 024 070	25,4	
	ABS	06.04-05.06	96				0 204 024 071	25,4	
FT 430 2.4 TDCi	ABO	07.06→	74/85/103				0 204 123 717	25,4	
	ABS	07.06→	74/85				0 204 123 716	25,4	
FT 430 2.4 TDCi, 2.4 TDCi 4x4	ABS	07.06→	103				0 204 123 716	25,4	
FT 430 2.4 TDCi 4x4	ABO	09.07→	103				0 204 123 717	25,4	
FT 460 2.4 TDCi, 2.4 TDCi 4x4	ABO	07.06→	103/147				0 204 123 717	25,4	
FT 460 3.2 TDCi	ABS	07.06→	103/147				0 204 123 716	25,4	
2.8		12.97→	68				F 026 003 354	23,8	
	FT 260 2.2 TDCi	04.06→	63/74/81/				0 204 125 857		0 204 127 528
	FT 280 2.2 TDCi		85/96/						
	FT 300 2.2 TDCi, 2.4 TDCi		100-107/147						
	FT 330 2.2 TDCi, 2.3i, 2.3i CNG								
	FT 330 2.3i LPG, 2.4 TDCi								
	FT 330 2.4 TDCi 4x4								
	FT 350 2.2 TDCi, 2.3i, 2.3i CNG								
	FT 350 2.3i LPG, 2.4 TDCi								
	FT 350 2.4 TDCi 4x4, 3.2 TDCi								
	FT 430 2.4 TDCi, 2.4 TDCi 4x4								
	FT 460 2.4 TDCi, 2.4 TDCi 4x4								
	FT 460 3.2 TDCi								
	FT 280 S 2.4 TDI	01.01-05.06	66		KW2		0 204 131 711 ¹⁰		
		12.02-02.04	66		KZB,KZE		0 204 131 703 ¹⁰		
		12.02-05.06	66		KZG,KZW		0 204 131 706 ¹⁰		
	FT 280 2.2 TDCi	04.06→	63/81/85/		KZB,KZE		0 204 131 703 ¹⁰		
			96/103		KZB,KZW		0 204 131 702 ¹⁰		
	FT 300 S 2.0 TDCi	05.02-05.06	92		KZB,KZE		0 204 131 703 ¹⁰		
		12.02-02.04	92		KZS,KZW		0 204 131 705 ¹⁰		
		12.02-05.06	92		KW2		0 204 131 711 ¹⁰		
					KZW,ORA		0 204 131 704 ¹⁰		
	FT 300 S 2.4 TDI	01.01-05.06	66/74/88		KW2		0 204 131 711 ¹⁰		
					KZW,ORA		0 204 131 704 ¹⁰		
		12.02-02.04	66/74/88		KZB,KZE		0 204 131 703 ¹⁰		
		12.02-05.06	66/74/88		KZG,KZW		0 204 131 706 ¹⁰		
	FT 300 2.2 TDCi	04.06→	63/81/85/		KW2		0 204 131 711 ¹⁰		
			96/103		KZB,KZE		0 204 131 703 ¹⁰		
					KZW,RSA		0 204 131 710 ¹⁰		
	FT 300 2.4 TDCi	07.06→	74		KW2		0 204 131 711 ¹⁰		
					KZB,KZW		0 204 131 702 ¹⁰		
					KZG,KZW		0 204 131 706 ¹⁰		
	FT 310 S 2.4 TDI	01.01-05.06	66/74/88		KW2		0 204 131 711 ¹⁰		
					KZW,ORA		0 204 131 704 ¹⁰		
		12.02-02.04	66/74/88		KZB,KZE		0 204 131 703 ¹⁰		
		12.02-05.06	66/74/88		KZG,KZW		0 204 131 706 ¹⁰		
	FT 330 L 2.4 TDI	01.01-05.06	66/88		KZB,KZE		0 204 131 703 ¹⁰		
					KZW,ORA		0 204 131 704 ¹⁰		
		12.02-02.04	66/88		KW2		0 204 131 711 ¹⁰		
		12.02-05.06	66/88		KZG,KZW		0 204 131 706 ¹⁰		
	FT 330 M 2.4 TDI	01.01-05.06	66/88		KZS,KZW		0 204 131 705 ¹⁰		
					KZW,ORA		0 204 131 704 ¹⁰		
		12.02-02.04	66/88		KZB,KZE		0 204 131 703 ¹⁰		











		S									
◀ FORD Transit											
FT 330 S 2.4 TDI	01.01-02.04	66/74/88				KZB,KZE	0 204 131 703 ¹⁰				
						01.01-05.06	66/74/88	KB2	0 204 131 701 ¹⁰		
						KZA,KZW	0 204 131 708 ¹⁰				
						KZW,ORA	0 204 131 704 ¹⁰				
						12.02-05.06	66/74/88	KZG,KZW	0 204 131 706 ¹⁰		
						KZW,RSA	0 204 131 710 ¹⁰				
FT 330 2.2 TDCi	04.06→	81/85/96/ 103				KB2	0 204 131 701 ¹⁰				
						KZA,KZW	0 204 131 708 ¹⁰				
						KZS,KZW	0 204 131 705 ¹⁰				
						KZW,RSA	0 204 131 710 ¹⁰				
FT 330 2.3i, 2.3i CNG, 2.3i LPG	04.06→	74/85/				KW2	0 204 131 711 ¹⁰				
FT 330 2.4 TDCi, 2.4 TDCi 4x4		100-107				KZA,KZW	0 204 131 708 ¹⁰				
						KZG,KZW	0 204 131 706 ¹⁰				
						KZS,KZW	0 204 131 705 ¹⁰				
						FT 350 E 2.4 TDI	01.01-05.06	66/88/96			
						KZW,ORA	0 204 131 704 ¹⁰				
						12.02-05.06	66/88/96	KZG,KZW	0 204 131 706 ¹⁰		
						KZS,KZW	0 204 131 705 ¹⁰				
FT 350 L 2.4 TDI	01.01-05.06	66/88				KZB,KZE	0 204 131 703 ¹⁰				
						KZA,KZW	0 204 131 708 ¹⁰				
						12.02-02.04	66/88	KZA,KZE	0 204 131 709 ¹⁰		
						KZG,KZW	0 204 131 706 ¹⁰				
						12.02-05.06	66/88	KZS,KZW	0 204 131 705 ¹⁰		
						KZW,ORA	0 204 131 704 ¹⁰				
						KZW,RSA	0 204 131 710 ¹⁰				
						06.04-05.06	96	KZA,KZE	0 204 131 709 ¹⁰		
						KZB,KZE	0 204 131 703 ¹⁰				
						KZG,KZW	0 204 131 706 ¹⁰				
						KZS,KZW	0 204 131 705 ¹⁰				
						KZW,ORA	0 204 131 704 ¹⁰				
						KZW,RSA	0 204 131 710 ¹⁰				
FT 350 M 2.4 TDI	01.01-05.06	66/88				KW2	0 204 131 711 ¹⁰				
						KZS,KZW	0 204 131 705 ¹⁰				
						12.02-02.04	66/88	KZB,KZE	0 204 131 703 ¹⁰		
						KZG,KZW	0 204 131 706 ¹⁰				
						12.02-05.06	66/88	KZW,ORA	0 204 131 704 ¹⁰		
						06.04-05.06	96	KW2	0 204 131 711 ¹⁰		
						KZG,KZW	0 204 131 706 ¹⁰				
						KZS,KZW	0 204 131 705 ¹⁰				
						KZW,ORA	0 204 131 704 ¹⁰				
FT 350 2.2 TDCi	04.06→	81/85/96/103				KZW,RSA	0 204 131 710 ¹⁰				
FT 350 2.3i, 2.3i CNG, 2.3i LPG	04.06→	74/85/				KZB,KZE	0 204 131 703 ¹⁰				
FT 350 2.4 TDCi, 2.4 TDCi 4x4		100-107/				KZG,KZW	0 204 131 706 ¹⁰				
FT 350 3.2 TDCi		147				KZS,KZW	0 204 131 705 ¹⁰				
						KZW,ORA	0 204 131 704 ¹⁰				
						KZW,RSA	0 204 131 710 ¹⁰				
FT 430 E 2.4 TDI	06.04-05.06	96				KZB,KZE	0 204 131 703 ¹⁰				
						KZG,KZW	0 204 131 706 ¹⁰				
						KZS,KZW	0 204 131 705 ¹⁰				
						KZW,ORA	0 204 131 704 ¹⁰				
FT 260 2.2 TDCi	04.06→	63/81/85/				FGS,TBR	1 987 482 035	← 1648			
						FT 280 2.2 TDCi	96/103				1 987 482 135
						KOB,TBR	1 987 477 174	← 1547			
											1 987 482 036
							1 987 477 186	1052			
						FT 280 S 2.4 TDI	01.01-05.06	66			PW
							1 987 482 036	→ 1283			
											OZB,PW
							1 987 477 185	→ 1386			
											PW,ZWB
							1 987 477 177	→ 1332			

		S							
FT 300 S 2.0 TDCi		05.02-05.06	92				1 987 477 186	1052	
						FGS,PW	1 987 482 035	← 1648	
							1 987 482 135	→ 1463	
						PW	1 987 477 174	← 1547	
							1 987 482 036	→ 1283	
FT 300 S 2.4 TDI		01.01-05.06	66/74/88				1 987 477 186	1052	
						PW	1 987 477 178	← 1528	
							1 987 482 036	→ 1283	
						OZB,PW	1 987 477 180	← 1608	
							1 987 477 185	→ 1386	
						PW,ZWB	1 987 477 175	← 1587	
							1 987 477 177	→ 1332	
FT 300 2.2 TDCi		04.06→	63/81/85/ 96/103				1 987 482 035	← 1648	
						FGS,TBR	1 987 482 135	→ 1463	
						KOB,TBR	1 987 477 174	← 1547	
							1 987 482 036	→ 1283	
FT 310 S 2.4 TDI		01.01-05.06	66/74/88				1 987 477 186	1052	
						PW	1 987 477 178	← 1528	
							1 987 482 036	→ 1283	
						OZB,PW	1 987 477 180	← 1608	
							1 987 477 185	→ 1386	
						PW,ZWB	1 987 477 175	← 1587	
							1 987 477 177	→ 1332	
FT 330 L 2.4 TDI		01.01-05.06	66/88				1 987 477 186	1052	
						MI	1 987 482 195	1919	
						PW	1 987 477 178	← 1528	
							1 987 482 036	→ 1283	
						OZB,PW	1 987 477 180	← 1608	
							1 987 477 185	→ 1386	
						PW,ZWB	1 987 477 175	← 1587	
							1 987 477 177	→ 1332	
FT 330 M 2.4 TDI		01.01-05.06	66/88				1 987 477 186	1052	
						MI	1 987 482 194	300	
						PW	1 987 477 178	← 1528	
							1 987 482 036	→ 1283	
						OZB,PW	1 987 477 180	← 1608	
							1 987 477 185	→ 1386	
						PW,ZWB	1 987 477 175	← 1587	
							1 987 477 177	→ 1332	
FT 330 S 2.4 TDI		01.01-05.06	66/74/88				1 987 477 186	1052	
						PW	1 987 477 178	← 1528	
							1 987 482 036	→ 1283	
						OZB,PW	1 987 477 180	← 1608	
							1 987 477 185	→ 1386	
						PW,ZWB	1 987 477 175	← 1587	
							1 987 477 177	→ 1332	
FT 350 E 2.4 TDI		01.01-05.06	66/88/96				1 987 477 186	1052	
FT 350 L 2.4 TDI						MI	1 987 482 195	1919	
						PW	1 987 477 178	← 1528	
							1 987 482 036	→ 1283	
						OZB,PW	1 987 477 180	← 1608	
							1 987 477 185	→ 1386	
						PW,ZWB	1 987 477 175	← 1587	
							1 987 477 177	→ 1332	



		S							
◀ FORD Transit									
FT 350 M 2.4 TDI		01.01-05.06	66/88				1987 477 186	1052	
							MI 1987 482 194	300	
							PW 1987 477 178	← 1528	
							1987 482 036	→ 1283	
							OZB,PW 1987 477 180	← 1608	
							1987 477 185	→ 1386	
							PW,ZWB 1987 477 175	← 1587	
							1987 477 177	→ 1332	
		06.04-05.06	96				1987 477 186	1052	
							MI 1987 482 194	300	
							PW 1987 477 178	← 1528	
							1987 482 036	→ 1283	
							OZB,PW 1987 477 180	← 1608	
							1987 477 185	→ 1386	
							PW,ZWB 1987 477 175	← 1587	
							1987 477 177	→ 1332	
FT 430 E 2.4 TDI		06.04-05.06	96				1987 477 186	1052	
							MI 1987 482 195	1919	
							PW 1987 477 178	← 1528	
							1987 482 036	→ 1283	
							OZB,PW 1987 477 180	← 1608	
							1987 477 185	→ 1386	
							PW,ZWB 1987 477 175	← 1587	
							1987 477 177	→ 1332	
2.8		12.97→	68				1987 477 369	2823	
FT 260 2.2 TDCi		04.06→	63/81				0265 231 704 ¹¹		
							0265 233 341 ¹⁴		
						MBH	0265 234 354 ²⁶		
			63/81/96/				0265 231 704 ¹¹		
			103				0265 233 341 ¹⁴		
						MBH	0265 234 354 ²⁶		
		10.08→	85				0265 231 704 ¹¹		
							0265 233 341 ¹⁴		
FT 280 2.2 TDCi		04.06→	63/81/96/				0265 231 704 ¹¹		
			103				0265 233 341 ¹⁴		
						MBH	0265 234 354 ²⁶		
		10.08→	85				0265 231 704 ¹¹		
							0265 233 341 ¹⁴		
FT 300 2.2 TDCi		04.06→	63/81/96/				0265 231 704 ¹¹		
			103				0265 233 341 ¹⁴		
						MBH	0265 234 354 ²⁶		
			96/103				0265 231 704 ¹¹		
							0265 233 341 ¹⁴		
		10.08→	85				0265 234 354 ²⁶		
							0265 231 704 ¹¹		
							0265 233 341 ¹⁴		
FT 300 2.4 TDCi		07.06→	74				0265 231 705 ¹¹		
							0265 233 342 ¹⁴		
						MBH	0265 234 355 ²⁶		
FT 330 2.2 TDCi		04.06→	81				0265 231 704 ¹¹		
							0265 233 341 ¹⁴		
						MBH	0265 234 354 ²⁶		
			96/103				0265 231 704 ¹¹		
							0265 233 341 ¹⁴		
		10.08→	85				0265 234 354 ²⁶		
							0265 231 704 ¹¹		
							0265 233 341 ¹⁴		
FT 330 2.3i		04.06→	100-107				0265 231 705 ¹¹		
FT 330 2.3i CNG									
FT 330 2.3i LPG		04.06→	107				0265 231 705 ¹¹		
							0265 233 342 ¹⁴		



		S							
FT 330 2.4 TDCi		07.06→	74/85				0 265 231 705 ¹¹		
							0 265 233 342 ¹⁴		
						MBH	0 265 234 355 ²⁶		
			103				0 265 231 705 ¹¹		
							0 265 233 342 ¹⁴		
						MBH	0 265 234 355 ²⁶		
FT 330 2.4 TDCi 4x4		09.07→	103				0 265 231 912 ¹¹		
							0 265 233 342 ¹⁴		
FT 350 2.2 TDCi		04.06→	81				0 265 231 704 ¹¹		
							0 265 233 341 ¹⁴		
						MBH	0 265 234 354 ²⁶		
			96/103				0 265 231 704 ¹¹		
							0 265 233 341 ¹⁴		
						MBH	0 265 234 354 ²⁶		
		10.08→	85				0 265 231 704 ¹¹		
							0 265 233 341 ¹⁴		
FT 350 2.3i, 2.3i CNG, 2.3i LPG		04.06→	100-107				0 265 231 705 ¹¹		
FT 350 2.4 TDCi		07.06→	74/85				0 265 231 705 ¹¹		
							0 265 233 342 ¹⁴		
						MBH	0 265 234 355 ²⁶		
			103				0 265 231 705 ¹¹		
							0 265 233 342 ¹⁴		
						MBH	0 265 234 355 ²⁶		
FT 350 2.4 TDCi 4x4		09.07→	103				0 265 231 912 ¹¹		
FT 350 3.2 TDCi		08.07→	74/85/147				0 265 231 705 ¹¹		
							0 265 233 342 ¹⁴		
						MBH	0 265 234 355 ²⁶		
FT 430 2.4 TDCi		07.06→	74/85/147				0 265 231 705 ¹¹		
							0 265 233 342 ¹⁴		
						MBH	0 265 234 355 ²⁶		
			103				0 265 231 705 ¹¹		
							0 265 233 342 ¹⁴		
						MBH	0 265 234 355 ²⁶		
FT 430 2.4 TDCi 4x4		09.07→	103				0 265 231 912 ¹¹		
FT 460 2.4 TDCi		07.06→	103				0 265 231 705 ¹¹		
							0 265 233 342 ¹⁴		
						MBH	0 265 234 355 ²⁶		
FT 460 2.4 TDCi 4x4		09.07→	103				0 265 231 912 ¹¹		
FT 460 3.2 TDCi		08.07→	147				0 265 231 705 ¹¹		
							0 265 233 342 ¹⁴		
						MBH	0 265 234 355 ²⁶		
 FT 280 S 2.4 TDI		01.01-09.03	66			LAB,OZB	0 265 006 461 ⁴		
						OZB,RAB	0 265 006 460 ⁴		
		01.01-05.06	66				0 265 006 458 ³		
						LAB,ZWB	0 265 006 814 ⁴		
						RAB,ZWB	0 265 006 813 ⁴		
		10.03-05.06	66			LAB,OZB	0 265 006 812 ⁴		
						OZB,RAB	0 265 006 811 ⁴		
FT 300 S 2.0 TDCi		05.02-05.04	92			LAB,TW	0 265 006 818 ⁴		
		05.02-05.06	92			RAB,TW	0 265 006 815 ⁴		
							0 265 006 817 ⁴		
						TW	0 265 006 458 ³		
							0 265 006 784 ³		
		07.03-05.06	92			LAB,TW	0 265 006 784 ⁴		
		05.04-05.06	92			LAB,TW	0 265 006 816 ⁴		
FT 300 S 2.4 TDI		01.01-09.03	66/74/88			LAB,OZB	0 265 006 461 ⁴		
						OZB,RAB	0 265 006 460 ⁴		
		01.01-05.06	66/74/88				0 265 006 458 ³		
						LAB,ZWB	0 265 006 814 ⁴		
						RAB,ZWB	0 265 006 813 ⁴		
		10.03-05.06	66/74/88			LAB,OZB	0 265 006 812 ⁴		
						OZB,RAB	0 265 006 811 ⁴		





◀ FORD Transit

FT 310 S 2.4 TDI	01.01-09.03	66/74/88	LAB,OZB	0 265 006 461 ⁴	
FT 330 L 2.4 TDI			OZB,RAB	0 265 006 460 ⁴	
FT 330 M 2.4 TDI	01.01-05.06	66/74/88		0 265 006 458 ³	
FT 330 S 2.4 TDI			LAB,ZWB	0 265 006 814 ⁴	
FT 350 E 2.4 TDI			RAB,ZWB	0 265 006 813 ⁴	
	10.03-05.06	66/74/88	LAB,OZB	0 265 006 812 ⁴	
			OZB,RAB	0 265 006 811 ⁴	
FT 350 E 2.4 TDI	06.04-05.06	96		0 265 006 458 ³	
			LAB,OZB	0 265 006 812 ⁴	
			LAB,ZWB	0 265 006 814 ⁴	
			OZB,RAB	0 265 006 811 ⁴	
			RAB,ZWB	0 265 006 813 ⁴	
FT 350 L 2.4 TDI	01.01-09.03	66/88	LAB,OZB	0 265 006 461 ⁴	
	01.01-05.06	66/88	OZB,RAB	0 265 006 460 ⁴	
			LAB,ZWB	0 265 006 814 ⁴	
			RAB,ZWB	0 265 006 813 ⁴	
	10.03-05.06	66/88	LAB,OZB	0 265 006 812 ⁴	
			OZB,RAB	0 265 006 811 ⁴	
	06.04-05.06	96		0 265 006 458 ³	
			LAB,OZB	0 265 006 812 ⁴	
			LAB,ZWB	0 265 006 814 ⁴	
			OZB,RAB	0 265 006 811 ⁴	
			RAB,ZWB	0 265 006 813 ⁴	
FT 350 M 2.4 TDI	01.01-09.03	66/88	LAB,OZB	0 265 006 461 ⁴	
	01.01-05.06	66/88	OZB,RAB	0 265 006 460 ⁴	
				0 265 006 458 ³	
			LAB,ZWB	0 265 006 814 ⁴	
			RAB,ZWB	0 265 006 813 ⁴	
	10.03-05.06	66/88	LAB,OZB	0 265 006 812 ⁴	
			OZB,RAB	0 265 006 811 ⁴	
FT 350 M 2.4 TDI	06.04-05.06	96		0 265 006 458 ³	
FT 430 E 2.4 TDI			LAB,OZB	0 265 006 812 ⁴	
			LAB,ZWB	0 265 006 814 ⁴	
			OZB,RAB	0 265 006 811 ⁴	
			RAB,ZWB	0 265 006 813 ⁴	



- FT 260** 2.2 TDCi 04.06→ 63/74/81/
- FT 280** 2.2 TDCi 85/96/
- FT 300** 2.2 TDCi, 2.4 TDCi 100-107/147
- FT 330** 2.2 TDCi, 2.3i, 2.3i CNG
- FT 330** 2.3i LPG, 2.4 TDCi
- FT 330** 2.4 TDCi 4x4
- FT 350** 2.2 TDCi, 2.3i, 2.3i CNG
- FT 350** 2.3i LPG, 2.4 TDCi
- FT 350** 2.4 TDCi 4x4, 3.2 TDCi
- FT 430** 2.4 TDCi, 2.4 TDCi 4x4
- FT 460** 2.4 TDCi, 2.4 TDCi 4x4
- FT 460** 3.2 TDCi

Transit Connect [02]



	1.8 i	05.02→	55/66/	1987 476 059	368
	1.8 TDCi		81-85		
	1.8 TDDi				
	1.8 i	05.02→	55/66/	0986 473 417	54 1987 470 506 ⁸
	1.8 TDCi		81-85		
	1.8 TDDi				



	1.8 i 1.8 TDCi 1.8 TDDi	05.02-10.07	55/66/ 81-85	SBR	1 987 481 168	345
--	-------------------------------	-------------	-----------------	-----	----------------------	-----

	1.8 i 1.8 TDCi 1.8 TDDi	05.02-03.09	55/66/ 81-85		0 986 475 927	↔ 20,64
--	-------------------------------	-------------	-----------------	--	----------------------	---------

	1.8 i 1.8 TDCi 1.8 TDDi	05.02→	55/66/ 81-85		0 986 473 418	↶ ← 36
					0 986 474 418	↷ → 36



	1.8 i 1.8 TDCi 1.8 TDDi	05.02→	55/66/ 81-85		0 986 486 066	
--	-------------------------------	--------	-----------------	--	----------------------	--

	1.8 i 1.8 TDCi 1.8 TDDi	05.02→	55/66/ 81-85		1 987 477 929	326
--	-------------------------------	--------	-----------------	--	----------------------	-----

Transit [E_]



	FT 080 2.0i	08.94-09.99	51/56/84		1 987 476 510	→ 430
	FT 080 2.5 D				1 987 476 511	← 430
	FT 080 2.5 DI	ABS, 10.99-08.00	51/56/84	OAS	1 987 476 510	→ 430
					1 987 476 511	← 430
	FT 080 2.5 TD	08.94-09.99	55/63/74		1 987 476 510	→ 430
					1 987 476 511	← 430
	FT 080 2.5 TDI	ABS, 10.99-08.00	55/63/74	OAS	1 987 476 510	→ 430
					1 987 476 511	← 430
	FT 080 2.5 TDI	08.94-09.99	63/85		1 987 476 510	→ 430
					1 987 476 511	← 430
	FT 080 2.5 TDI	ABS, 10.99-08.00	63/85	OAS	1 987 476 510	→ 430
					1 987 476 511	← 430
	FT 100 2.0i	08.94-09.99	51/56/84		1 987 476 510	→ 430
					1 987 476 511	← 430
	FT 100 2.5 D				1 987 476 511	← 430
	FT 100 2.5 DI	ABS, 10.99-08.00	51/56/84	OAS	1 987 476 510	→ 430
					1 987 476 511	← 430
	FT 100 2.5 TD	08.94-09.99	63/74		1 987 476 510	→ 430
					1 987 476 511	← 430
	FT 100 2.5 TD	ABS, 10.99-08.00	63/74	OAS	1 987 476 510	→ 430
					1 987 476 511	← 430
	FT 100 2.5 TDI	08.94-09.99	63/85		1 987 476 510	→ 430
					1 987 476 511	← 430
	FT 100 2.5 TDI	ABS, 10.99-08.00	63/85	OAS	1 987 476 510	→ 430
					1 987 476 511	← 430
	FT 120 2.0i	08.94-09.99	51/56/84		1 987 476 510	→ 430
					1 987 476 511	← 430
	FT 120 2.5 D				1 987 476 511	← 430
	FT 120 2.5 DI	ABS, 10.99-08.00	51/56/84	OAS	1 987 476 510	→ 430
					1 987 476 511	← 430
	FT 120 2.5 TD	08.94-09.99	63/74		1 987 476 510	→ 430
					1 987 476 511	← 430
	FT 120 2.5 TD	ABS, 10.99-08.00	63/74	OAS	1 987 476 510	→ 430
					1 987 476 511	← 430



		S							
◀ FORD Transit [E_]									
FT 120 2.5 TDI		03.99-09.99	56/84/85				1987 476 510	→ 430	
							1987 476 511	← 430	
	ABS,	10.99-08.00	56/84/85				1987 476 510	→ 430	
	OAS						1987 476 511	← 430	
FT 150 2.0i		08.94-09.99	56/84/85				1987 476 510	→ 430	
FT 150 2.5 DI							1987 476 511	← 430	
	ABS,	10.99-08.00	56/84/85				1987 476 510	→ 430	
	OAS						1987 476 511	← 430	
FT 150 2.5 TD		08.94-09.99	63/74				1987 476 510	→ 430	
							1987 476 511	← 430	
	ABS,	10.99-08.00	63/74				1987 476 510	→ 430	
	OAS						1987 476 511	← 430	
FT 150 2.5 TDI		08.94-09.99	63/85				1987 476 510	→ 430	
							1987 476 511	← 430	
	ABS,	10.99-08.00	63/85				1987 476 510	→ 430	
	OAS						1987 476 511	← 430	
FT 190 2.0i		08.94-09.99	56/84				1987 476 510	→ 430	
FT 190 2.5 DI							1987 476 511	← 430	
	ABS,	10.99-08.00	56/84				1987 476 510	→ 430	
	OAS						1987 476 511	← 430	
FT 190 2.5 TD		08.94-09.99	63/74				1987 476 510	→ 430	
							1987 476 511	← 430	
	ABS,	10.99-08.00	63/74				1987 476 510	→ 430	
	OAS						1987 476 511	← 430	
FT 190 2.5 TDI		08.94-09.99	63/85				1987 476 510	→ 430	
							1987 476 511	← 430	
	ABS,	10.99-08.00	63/85				1987 476 510	→ 430	
	OAS						1987 476 511	← 430	
2.0 i LWB 100-190, i SWB 80-150		08.91-07.94	51-52/59/		LAB		1987 476 511	430	
2.0 LWB 100-190, SWB 80-150			63/66/72/		RAB		1987 476 510	430	
2.5 DI LWB 100 L, DI LWB 100-190			74/104						
2.5 DI SWB 80-120, DI SWB 80-150									
2.5 DI Turbo LWB 100-190									
2.5 DI Turbo LWB 150+190 L									
2.5 DI Turbo SWB 80-150									
2.5 DI Turbo SWB 150 S									
2.9 V6 LWB 100 L-190									
FT 080 2.0i, 2.5 D, 2.5 DI		08.94-08.00	51/55/56/		5LO		0 204 102 925	→ 42	0 204 104 135 ⁷
FT 080 2.5 TD, 2.5 TDI			63/74/84/				0 204 103 925		
FT 100 2.0i, 2.5 D, 2.5 DI			85				0 204 102 926	← 42	0 204 104 135 ⁷
FT 100 2.5 TD, 2.5 TDI							0 204 103 926		
FT 120 2.0i, 2.5 D, 2.5 DI					6LO		0 204 102 934	→ 42	0 204 104 135 ⁷
FT 120 2.5 TD, 2.5 TDI							0 204 102 935	← 42	0 204 104 135 ⁷
FT 150 2.0i, 2.5 DI, 2.5 TD, 2.5 TDI									
FT 190 2.0i, 2.5 DI									
FT 190 2.5 TD, 2.5 TDI									
2.0 i LWB 100-190, i SWB 80-150		08.91-07.94	51-52/59/		14Z		0 204 102 925	→ 42	0 204 100 277 ⁸
2.0 LWB 100-190, SWB 80-150			63/66/72/				0 204 103 925		0 204 104 135 ⁷
2.5 DI LWB 100 L, DI LWB 100-190			74/104				0 204 102 926	← 42	0 204 100 277 ⁸
2.5 DI SWB 80-120, DI SWB 80-150							0 204 103 926		
2.5 DI Turbo LWB 100-190					15Z		0 204 102 934	→ 42	0 204 100 277 ⁸
2.5 DI Turbo LWB 150+190 L							0986 474 179		0 204 104 135 ⁷
2.5 DI Turbo SWB 80-150							0 204 102 935	← 42	0 204 100 277 ⁸
2.5 DI Turbo SWB 150 S							0986 473 179		
2.9 V6 LWB 100 L-190									



	FT 080 2.0i		08.94-08.00	51/56/84		BRV	1 987 476 614	447
	FT 080 2.5 D	ABS,	08.94-08.00	51/56/84		BRD	1 987 476 615	415
	FT 080 2.5 DI	OAS						
	FT 080 2.5 TD		08.94-08.00	63/74		BRV	1 987 476 614	447
		ABS,	08.94-08.00	63/74		BRD	1 987 476 615	415
		OAS						
	FT 080 2.5 TDI		08.94-08.00	63/85		BRV	1 987 476 614	447
		ABS,	08.94-08.00	63/85		BRD	1 987 476 615	415
		OAS						
	FT 100 2.0i		08.94-08.00	51/56/84		BRV	1 987 476 614	447
	FT 100 2.5 D	ABS,	08.94-08.00	51/56/84		BRD	1 987 476 615	415
	FT 100 2.5 DI	OAS						
	FT 100 2.5 TD		08.94-08.00	63/74		BRV	1 987 476 614	447
		ABS,	08.94-08.00	63/74		BRD	1 987 476 615	415
		OAS						
	FT 100 2.5 TDI		08.94-08.00	63/85		BRV	1 987 476 614	447
		ABS,	08.94-08.00	63/85		BRD	1 987 476 615	415
		OAS						
	FT 120 2.0i		08.94-08.00	51/56/84		BRV	1 987 476 614	447
	FT 120 2.5 D	ABS,	08.94-08.00	51/56/84		BRD	1 987 476 615	415
	FT 120 2.5 DI	OAS						
	FT 120 2.5 TD		08.94-08.00	63/74		BRV	1 987 476 614	447
		ABS,	08.94-08.00	63/74		BRD	1 987 476 615	415
		OAS						
	FT 120 2.5 TDI		03.99-08.00	56/84/85		BRV	1 987 476 614	447
		ABS,	03.99-08.00	56/84/85		BRD	1 987 476 615	415
		OAS						
	FT 150 2.0i		08.94-08.00	56/84/85		BRV	1 987 476 614	447
	FT 150 2.5 DI	ABS,	08.94-08.00	56/84/85		BRD	1 987 476 615	415
		OAS						
	FT 150 2.5 TD		08.94-08.00	63/74		BRV	1 987 476 614	447
		ABS,	08.94-08.00	63/74		BRD	1 987 476 615	415
		OAS						
	FT 150 2.5 TDI		08.94-08.00	63/85		BRV	1 987 476 614	447
		ABS,	08.94-08.00	63/85		BRD	1 987 476 615	415
		OAS						
	FT 190 2.0i		08.94-08.00	56/84		BRV	1 987 476 614	447
	FT 190 2.5 DI	ABS,	08.94-08.00	56/84		BRD	1 987 476 615	415
		OAS						
	FT 190 2.5 TD		08.94-08.00	63/74		BRV	1 987 476 614	447
		ABS,	08.94-08.00	63/74		BRD	1 987 476 615	415
		OAS						
	FT 190 2.5 TDI		08.94-08.00	63/85		BRV	1 987 476 614	447
		ABS,	08.94-08.00	63/85		BRD	1 987 476 615	415
		OAS						
	2.0 i LWB 100-190, i SWB 80-150		08.91-07.94	51-52/59/		BRD	1 987 476 615	415
	2.0 LWB 100-190, SWB 80-150			63/66/72/		BRV	1 987 476 614	447
	2.5 DI LWB 100 L, DI LWB 100-190			74/104				
	2.5 DI SWB 80-120, DI SWB 80-150							
	2.5 DI Turbo LWB 100-190							
	2.5 DI Turbo LWB 150+190 L							
	2.5 DI Turbo SWB 80-150							
	2.5 DI Turbo SWB 150 S							
	2.9 V6 LWB 100 L-190							













◀ FORD Transit [E_]

	FT 080 2.0i, 2.5 D, 2.5 DI	08.94-08.00	51/56/63/	F 026 002 171	↔ 20,6
	FT 080 2.5 TD, 2.5 TDI		74/84/85	F 026 002 172	↔ 22,19
	FT 100 2.0i, 2.5 D, 2.5 DI				
	FT 100 2.5 TD, 2.5 TDI				
	FT 120 2.0i, 2.5 D, 2.5 DI				
	FT 120 2.5 TD, 2.5 TDI				
	FT 150 2.0i, 2.5 DI	08.94-08.00	56/63/74/	F 026 002 171	↔ 20,6
	FT 150 2.5 TD, 2.5 TDI		84/85		
	FT 190 2.0i, 2.5 DI, 2.5 TD	08.94-08.00	56/63/74/	F 026 002 173	↔ 25,4
	FT 190 2.5 TDI		84/85		
	2.0 i LWB 100-190, i SWB 80-150	08.91-07.94	51-52/59/	F 026 002 171	↔ 20,6
	2.0 LWB 100-190, SWB 80-150		63/66/72/	F 026 002 172	↔ 22,19
	2.5 DI LWB 100 L, DI LWB 100-190		74/104	F 026 002 173	↔ 25,4
	2.5 DI SWB 80-120, DI SWB 80-150				
	2.5 DI Turbo LWB 100-190				
	2.5 DI Turbo LWB 150+190 L				
	2.5 DI Turbo SWB 80-150				
	2.5 DI Turbo SWB 150 S				
	2.9 V6 LWB 100 L-190				



	FT 080 2.0i	ABO	08.94-03.97	51/56/84	F 026 003 136	23,8
	FT 080 2.5 D		04.97-08.00	51/56/84	F 026 003 354	23,8
	FT 080 2.5 DI	ABS	04.97-08.00	51/56/84	0 204 123 355	23,8
	FT 080 2.5 TD	ABO	08.94-03.97	55/63/74	F 026 003 136	23,8
			04.97-08.00	55/63/74	F 026 003 354	23,8
		ABS	04.97-08.00	55/63/74	0 204 123 355	23,8
	FT 080 2.5 TDI	ABO	08.94-03.97	63	F 026 003 136	23,8
			04.97-08.00	63	F 026 003 354	23,8
			03.99-08.00	85	F 026 003 354	23,8
		ABS	04.97-08.00	63/85	0 204 123 355	23,8
	FT 100 2.0i	ABO	08.94-03.97	51/56/84	F 026 003 136	23,8
	FT 100 2.5 D		04.97-08.00	51/56/84	F 026 003 354	23,8
	FT 100 2.5 DI	ABS	04.97-08.00	51/56/84	0 204 123 355	23,8
	FT 100 2.5 TD	ABO	08.94-03.97	63/74	F 026 003 136	23,8
			04.97-08.00	63/74	F 026 003 354	23,8
		ABS	04.97-08.00	63/74	0 204 123 355	23,8
	FT 100 2.5 TDI	ABO	08.94-03.97	63	F 026 003 136	23,8
			04.97-08.00	63	F 026 003 354	23,8
			03.99-08.00	85	F 026 003 354	23,8
		ABS	04.97-08.00	63/85	0 204 123 355	23,8
	FT 120 2.0i	ABO	08.94-03.97	51/56/84	F 026 003 136	23,8
	FT 120 2.5 D		04.97-08.00	51/56/84	F 026 003 354	23,8
	FT 120 2.5 DI	ABS	04.97-08.00	51/56/84	0 204 123 355	23,8
	FT 120 2.5 TD	ABO	08.94-03.97	63/74	F 026 003 136	23,8
			04.97-08.00	63/74	F 026 003 354	23,8
		ABS	04.97-08.00	63/74	0 204 123 355	23,8
	FT 120 2.5 TDI	ABO	03.99-08.00	85	F 026 003 354	23,8
		ABS	03.99-08.00	85	0 204 123 355	23,8
	FT 150 2.0i	ABO	08.94-03.97	56/84	F 026 003 136	23,8
	FT 150 2.5 DI		04.97-08.00	56/84	F 026 003 354	23,8
		ABS	04.97-08.00	56/84	0 204 123 355	23,8
	FT 150 2.5 TD	ABO	08.94-03.97	63/74	F 026 003 136	23,8
			04.97-08.00	63/74	F 026 003 354	23,8
		ABS	04.97-08.00	63/74	0 204 123 355	23,8
	FT 150 2.5 TDI	ABO	08.94-03.97	63	F 026 003 136	23,8
			04.97-08.00	63	F 026 003 354	23,8
			03.99-08.00	85	F 026 003 354	23,8
		ABS	04.97-08.00	63/85	0 204 123 355	23,8











		S							
FT 190 2.0i	ABO	08.94-03.97	56/84				F 026 003 136	23,8	
FT 190 2.5 DI		04.97-08.00	56/84				F 026 003 354	23,8	
	ABS	04.97-08.00	56/84				0 204 123 355	23,8	
FT 190 2.5 TD	ABO	08.94-03.97	63/74				F 026 003 136	23,8	
		04.97-08.00	63/74				F 026 003 354	23,8	
	ABS	04.97-08.00	63/74				0 204 123 355	23,8	
FT 190 2.5 TDI	ABO	08.94-03.97	63				F 026 003 136	23,8	
		04.97-08.00	63				F 026 003 354	23,8	
		03.99-08.00	85				F 026 003 354	23,8	
	ABS	04.97-08.00	63/85				0 204 123 355	23,8	
2.0i LWB 100-190, i SWB 80-150	ABO	08.91-07.94	51-52/59/				F 026 003 136	23,8	
2.0 LWB 100-190, SWB 80-150			63/66/72/						
2.5 DI LWB 100 L, DI LWB 100-190			74/104						
2.5 DI SWB 80-120, DI SWB 80-150									
2.5 DI Turbo LWB 100-190									
2.5 DI Turbo LWB 150+190 L									
2.5 DI Turbo SWB 80-150									
2.5 DI Turbo SWB 150 S									
2.9 V6 LWB 100 L-190									
 FT 080 2.0i		04.97-08.00	51/56/84		LLE		0 204 125 531		
FT 080 2.5 D	ABO	08.94-03.97	51/56/84		LLE		0 204 125 101		
FT 080 2.5 DI					LLE,Z9		0 204 125 127		
FT 080 2.5 TD		04.97-08.00	55/63/74		LLE		0 204 125 531		
	ABO	08.94-03.97	55/63/74		LLE		0 204 125 101		
					LLE,Z9		0 204 125 127		
FT 080 2.5 TDI		04.97-08.00	63/85		LLE		0 204 125 531		
	ABO	08.94-03.97	63		LLE		0 204 125 101		
					LLE,Z9		0 204 125 127		
FT 100 2.0i		04.97-08.00	51/56/84		LLE		0 204 125 531		
FT 100 2.5 D	ABO	08.94-03.97	51/56/84		LLE		0 204 125 101		
FT 100 2.5 DI					LLE,Z9		0 204 125 127		
FT 100 2.5 TD		04.97-08.00	63/74		LLE		0 204 125 531		
	ABO	08.94-03.97	63/74		LLE		0 204 125 101		
					LLE,Z9		0 204 125 127		
FT 100 2.5 TDI		04.97-08.00	63/85		LLE		0 204 125 531		
	ABO	08.94-03.97	63		LLE		0 204 125 101		
					LLE,Z9		0 204 125 127		
FT 120 2.0i		04.97-08.00	51/56/84		LLE		0 204 125 531		
FT 120 2.5 D	ABO	08.94-03.97	51/56/84		LLE		0 204 125 101		
FT 120 2.5 DI					LLE,Z9		0 204 125 127		
FT 120 2.5 TD		04.97-08.00	63/74		LLE		0 204 125 531		
	ABO	08.94-03.97	63/74		LLE		0 204 125 101		
					LLE,Z9		0 204 125 127		
FT 120 2.5 TDI		03.99-08.00	85		LLE		0 204 125 531		
FT 150 2.0i		04.97-08.00	56/84		LLE		0 204 125 531		
FT 150 2.5 DI	ABO	08.94-03.97	56/84		LLE		0 204 125 101		
					LLE,Z9		0 204 125 127		
FT 150 2.5 TD		04.97-08.00	63/74		LLE		0 204 125 531		
	ABO	08.94-03.97	63/74		LLE		0 204 125 101		
					LLE,Z9		0 204 125 127		
FT 150 2.5 TDI		04.97-08.00	63/85		LLE		0 204 125 531		
	ABO	08.94-03.97	63		LLE		0 204 125 101		
					LLE,Z9		0 204 125 127		
FT 190 2.0i		04.97-08.00	56/84		LLE		0 204 125 531		
FT 190 2.5 DI	ABO	08.94-03.97	56/84		LLE		0 204 125 101		
					LLE,Z9		0 204 125 127		
FT 190 2.5 TD		04.97-08.00	63/74		LLE		0 204 125 531		
	ABO	08.94-03.97	63/74		LLE		0 204 125 101		
					LLE,Z9		0 204 125 127		
FT 190 2.5 TDI		04.97-08.00	63/85		LLE		0 204 125 531		
	ABO	08.94-03.97	63		LLE		0 204 125 101		
					LLE,Z9		0 204 125 127		





◀ FORD Transit [E_...]						
2.0 i LWB 100-190, i SWB 80-150	ABO	08.91-07.94	51-52/59/			0 204 125 068
2.0 LWB 100-190, SWB 80-150			63/66/72/			
2.5 DI LWB 100 L, DI LWB 100-190			74/104			
2.5 DI SWB 80-120, DI SWB 80-150						
2.5 DI Turbo LWB 100-190						
2.5 DI Turbo LWB 150+190 L						
2.5 DI Turbo SWB 80-150						
2.5 DI Turbo SWB 150 S						
2.9 V6 LWB 100 L-190						
 FT 080 2.0i		08.94-07.00	84	Org.Nr. Typ 80,100S,120	BRD	0 204 131 359 ¹⁰
					BRV	0 204 131 354 ¹⁰
FT 080 2.5 D, 2.5 DI, 2.5 TD,		08.94-08.00	51/55/56/	Org.Nr. Typ 80,100S,120	BRD	0 204 131 367 ¹⁰
FT 080 2.5 TDI			63/74/85		BRV	0 204 031 299 ¹⁰
FT 100 2.0i		08.94-07.00	84	Org.Nr. Typ 80,100S,120	BRD	0 204 131 359 ¹⁰
					BRV	0 204 131 354 ¹⁰
				Org.Nr. Typ 100L-150L,150S	BRV	0 204 131 356 ¹⁰
				Org.Nr. Typ 130/150S/150L	BRV	0 204 131 368 ¹⁰
FT 100 2.5 D		08.94-08.00	51/56/63/	Org.Nr. Typ 80,100S,120	BRD	0 204 131 367 ¹⁰
FT 100 2.5 DI			74/85		BRV	0 204 031 299 ¹⁰
FT 100 2.5 TD				Org.Nr. Typ 100L-150L,150S	BRD	0 204 131 360 ¹⁰
FT 100 2.5 TDI					BRV	0 204 031 298 ¹⁰
FT 120 2.0i		08.94-07.00	84	Org.Nr. Typ 80,100S,120	BRD	0 204 131 359 ¹⁰
					BRV	0 204 131 354 ¹⁰
				Org.Nr. Typ 100L-150L,150S	BRV	0 204 131 356 ¹⁰
FT 120 2.5 D		08.94-08.00	51/56/63/	Org.Nr. Typ 80,100S,120	BRD	0 204 131 367 ¹⁰
FT 120 2.5 DI			74/85		BRV	0 204 031 299 ¹⁰
FT 120 2.5 TD				Org.Nr. Typ 100L-150L,150S	BRD	0 204 131 360 ¹⁰
FT 120 2.5 TDI					BRV	0 204 031 298 ¹⁰
FT 150 2.0i		08.94-07.00	84	Org.Nr. Typ 150L	BRV,TW	0 204 131 366 ¹⁰
				Org.Nr. Typ 150L,150S	BRV,TW	0 204 131 356 ¹⁰
				Org.Nr. Typ 150L,190	BRD	0 204 131 369 ¹⁰
				Org.Nr. Typ 150S,150L	BRV,TW	0 204 131 368 ¹⁰
FT 150 2.5 DI		08.94-08.00	56/63/74/	Org.Nr. Typ 100L-150L,150S	BRD,TW	0 204 131 360 ¹⁰
FT 150 2.5 TD			85		BRV	0 204 031 298 ¹⁰
FT 150 2.5 TDI				Org.Nr. Typ 150L	BRD,TW	0 204 131 680 ¹⁰
FT 190 2.0i		08.94-07.00	84	Org.Nr. Typ 150L,190	BRD	0 204 131 369 ¹⁰
					BRV	0 204 131 366 ¹⁰
FT 190 2.5 DI, 2.5 TD, 2.5 TDI		08.94-08.00	56/63/74/		BRD	0 204 131 680 ¹⁰
			85		BRV	0 204 131 358 ¹⁰
2.0 i LWB 100-190		08.91-07.94	66/72	Org.Nr. Typ 100L-150L,150S	BRD,BUS	0 204 131 368 ¹⁰
					BRV,BUS	0 204 131 356 ¹⁰
				Org.Nr. Typ 150L	BRV,BUS	0 204 131 366 ¹⁰
				Org.Nr. TYP 150L	BRD,BUS	0 204 131 369 ¹⁰
				Org.Nr. Typ 190	BRV	0 204 131 366 ¹⁰
				Org.Nr. TYP 190	BRD	0 204 131 369 ¹⁰
2.0 i SWB 80-150		08.91-07.94	66/72	Org.Nr. Typ 80,100S,120	BRD	0 204 131 359 ¹⁰
					BRV	0 204 131 354 ¹⁰
				Org.Nr. Typ 130/150S/150L	BRD	0 204 131 368 ¹⁰
					BRV	0 204 131 356 ¹⁰
2.0 LWB 100-190		08.91-07.94	66/72	Org.Nr. Typ 100L-150L,150S	BRD,BUS	0 204 131 368 ¹⁰
					BRV,BUS	0 204 131 356 ¹⁰
				Org.Nr. Typ 150L	BRV,BUS	0 204 131 366 ¹⁰
				Org.Nr. TYP 150L	BRD,BUS	0 204 131 369 ¹⁰
				Org.Nr. Typ 190	BRV	0 204 131 366 ¹⁰
				Org.Nr. TYP 190	BRD	0 204 131 369 ¹⁰
2.0 SWB 80-150		08.91-07.94	66/72	Org.Nr. Typ 80,100S,120	BRD	0 204 131 359 ¹⁰
					BRV	0 204 131 354 ¹⁰
				Org.Nr. Typ 130/150S/150L	BRD	0 204 131 368 ¹⁰
					BRV	0 204 131 356 ¹⁰
2.5 DI LWB 100 L		08.91-07.94	52	Org.Nr. Typ 100L-150L,150S	BRD,BUS	0 204 131 360 ¹⁰
				Org.Nr. 100L-150L,150S	BRV,BUS	0 204 031 298 ¹⁰



									
2.5 DI LWB 100-190	08.91-07.94	59	Org.Nr. Typ 100L-150L,150S	BRD,BUS	0 204 131 360 ¹⁰				
				Org.Nr. Typ 150L	BRD,BUS	0 204 131 680 ¹⁰			
					BRV,BUS	0 204 131 358 ¹⁰			
				Org.Nr. Typ 190	BRD	0 204 131 680 ¹⁰			
					BRV	0 204 131 358 ¹⁰			
2.5 DI SWB 80-120	08.91-07.94	51-52	Org.Nr. Typ 80,100S,120	BRD	0 204 131 367 ¹⁰				
					BRV	0 204 031 299 ¹⁰			
2.5 DI SWB 80-150	08.91-07.94	59	Org.Nr. Typ 80,100S,120	BRD	0 204 131 367 ¹⁰				
					BRV	0 204 031 299 ¹⁰			
				Org.Nr. Typ 130/150S/150L	BRD	0 204 131 360 ¹⁰			
				BRV	0 204 031 298 ¹⁰				
2.5 DI Turbo LWB 100-190 2.5 DI Turbo LWB 150+190 L	08.91-07.94	63/74	Org.Nr. Typ 100L-150L,150S	BRD,BUS	0 204 131 360 ¹⁰				
				Org.Nr. Typ 150L	BRD,BUS	0 204 131 680 ¹⁰			
					BRV,BUS	0 204 131 358 ¹⁰			
				Org.Nr. Typ 190	BRD	0 204 131 680 ¹⁰			
					BRV	0 204 131 358 ¹⁰			
				BRV,BUS	0 204 031 298 ¹⁰				
2.5 DI Turbo SWB 80-150	10.92-07.94	63	Org.Nr. Typ 80,100S,120	BRD	0 204 131 367 ¹⁰				
					BRV	0 204 031 299 ¹⁰			
				Org.Nr. Typ 130/150S/150L	BRD	0 204 131 360 ¹⁰			
				BRV	0 204 031 298 ¹⁰				
2.5 DI Turbo SWB 150 S	08.91-07.94	74	Org.Nr. Typ 130/150S/150L	BRD	0 204 131 360 ¹⁰				
					BRV	0 204 031 298 ¹⁰			
2.9 V6 LWB 100 L-190	08.91-07.94	104	Org.Nr. Typ 100L-150L,150S,	BRD	0 204 131 360 ¹⁰				
				Org.Nr. Typ 130	BRV	0 204 031 298 ¹⁰			
				Org.Nr. Typ 190	BRD	0 204 131 680 ¹⁰			
				BRV	0 204 131 358 ¹⁰				
	FT 080 2.0i, 2.5 D, 2.5 DI	08.94-08.00	51/55/56/		OZB	1 987 477 369	2823		
	FT 080 2.5 TD, 2.5 TDI		63/74/84/		ZWB	1 987 477 370	2730		
	FT 100 2.0i, 2.5 D, 2.5 DI		85						
	FT 100 2.5 TD, 2.5 TDI								
	FT 120 2.0i, 2.5 D, 2.5 DI								
	FT 120 2.5 TD, 2.5 TDI								
	FT 150 2.0i, 2.5 DI, 2.5 TD								
	FT 150 2.5 TDI								
	FT 190 2.0i, 2.5 DI								
	FT 190 2.5 TD, 2.5 TDI								
	2.0 i LWB 100-190, i SWB 80-150	08.91-07.94	51-52/59/		ABM,OZB	1 987 477 369	2823		
	2.0 LWB 100-190, SWB 80-150		63/66/72/		ABM,ZWB	1 987 477 370	2730		
	2.5 DI LWB 100 L, DI LWB 100-190		74/104						
2.5 DI SWB 80-120, DI SWB 80-150									
2.5 DI Turbo LWB 100-190									
2.5 DI Turbo LWB 150+190 L									
2.5 DI Turbo SWB 80-150									
2.5 DI Turbo SWB 150 S									
2.9 V6 LWB 100 L-190									
	FT 080 2.0i, 2.5 D	11.97-08.00	51/84			0 265 220 468 ¹⁸			
	FT 080 2.5 DI	11.97-08.00	56			0 265 220 468 ¹⁸			
		ABS, 11.97-08.00	56		AK	0 265 216 625 ¹⁶			
		OAS							
	FT 080 2.5 TD, 2.5 TDI	11.97-08.00	51/55/63/74/84/85			0 265 220 468 ¹⁸			
	FT 100 2.0i, 2.5 D	11.97-08.00	51/55/63/74/84/85			0 265 220 468 ¹⁸			
	FT 100 2.5 DI	11.97-08.00	56			0 265 220 468 ¹⁸			
		ABS, 11.97-08.00	56		AK	0 265 216 625 ¹⁶			
		OAS							
	FT 100 2.5 TD, 2.5 TDI	11.97-08.00	51/63/74/84/85			0 265 220 468 ¹⁸			
	FT 120 2.0i, 2.5 D	11.97-08.00	51/63/74/84/85			0 265 220 468 ¹⁸			
	FT 120 2.5 DI	11.97-08.00	56			0 265 220 468 ¹⁸			
		ABS, 11.97-08.00	56		AK	0 265 216 625 ¹⁶			
	OAS								





	◀ FORD Transit [E_...]							
	FT 120 2.5 TD, 2.5 TDI	11.97-08.00	63/74/84/85			0 265 220 468 ¹⁸		
	FT 150 2.0i, 2.5 TD, 2.5 TDI	11.97-08.00	63/74/84/85			0 265 220 468 ¹⁸		
	FT 150 2.5 DI	11.97-08.00	56			0 265 220 468 ¹⁸		
	ABS, 11.97-08.00	56			AK	0 265 216 625 ¹⁶		
	OAS							
	FT 190 2.0i	11.97-07.00	63/74/84/85			0 265 220 468 ¹⁸		
	FT 190 2.5 DI	11.97-08.00	56			0 265 220 468 ¹⁸		
	ABS, 11.97-08.00	56			AK	0 265 216 625 ¹⁶		
	OAS							
	FT 190 2.5 TD, 2.5 TDI	11.97-08.00	63/74/85			0 265 220 468 ¹⁸		

	FT 080 2.0i, 2.5 D	11.97-08.00	51/84			1 273 004 260 ¹⁸		
	FT 080 2.5 DI	11.97-08.00	56			1 273 004 260 ¹⁸		
	ABS, 11.97-08.00	56			AK	1 273 004 340 ¹⁶		
	OAS							
	FT 080 2.5 TD, 2.5 TDI	11.97-08.00	51/55/63/74/84/85			1 273 004 260 ¹⁸		
	FT 100 2.0i, 2.5 D	11.97-08.00	51/55/63/74/84/85			1 273 004 260 ¹⁸		
	FT 100 2.5 DI	11.97-08.00	56			1 273 004 260 ¹⁸		
	ABS, 11.97-08.00	56			AK	1 273 004 340 ¹⁶		
	OAS							
	FT 100 2.5 TD, 2.5 TDI	11.97-08.00	51/63/74/84/85			1 273 004 260 ¹⁸		
	FT 120 2.0i, 2.5 D	11.97-08.00	51/63/74/84/85			1 273 004 260 ¹⁸		
	FT 120 2.5 DI	11.97-08.00	56			1 273 004 260 ¹⁸		
	ABS, 11.97-08.00	56			AK	1 273 004 340 ¹⁶		
	OAS							
	FT 120 2.5 TD, 2.5 TDI	11.97-08.00	63/74/84/85			1 273 004 260 ¹⁸		
	FT 150 2.0i, 2.5 TD, 2.5 TDI	11.97-08.00	63/74/84/85			1 273 004 260 ¹⁸		
	FT 150 2.5 DI	11.97-08.00	56			1 273 004 260 ¹⁸		
	ABS, 11.97-08.00	56			AK	1 273 004 340 ¹⁶		
	OAS							
	FT 190 2.0i	11.97-07.00	63/74/84/85			1 273 004 260 ¹⁸		
	FT 190 2.5 DI	11.97-08.00	56			1 273 004 260 ¹⁸		
	ABS, 11.97-08.00	56			AK	1 273 004 340 ¹⁶		
	OAS							
	FT 190 2.5 TD, 2.5 TDI	11.97-08.00	63/74/85			1 273 004 260 ¹⁸		



Transit Euroline

	2.2 TDCi	04.06→	81/85/96/ 103			0 204 004 617	← 48	
						0 204 004 618	→	
	2.2 TDCi	04.06→	81/85/96/ 103			F 026 002 578	↔ 25,4	
	2.2 TDCi	04.06→	81/85/96/ 103			0 204 902 026	← 48	
						0 204 902 027	→ 48	
	2.2 TDCi	ABO 04.06→	81/85/96/103			0 204 123 717	25,4	
		ABS 04.06→	81/85/96/103			0 204 123 716	25,4	

		S							
	2.2 TDCi	04.06→	81/85/96/103				0 204 125 857		0 204 127 528
	2.2 TDCi	04.06→	81/85/96/103		KZB,KZE KZW,RSA		0 204 131 703 ¹⁰ 0 204 131 710 ¹⁰		
	2.2 TDCi	04.06→	81				0 265 231 704 ¹¹ 0 265 233 341 ¹⁴ MBH 0 265 234 354 ²⁶ 96/103 0 265 231 704 ¹¹ 0 265 233 341 ¹⁴ MBH 0 265 234 354 ²⁶ 10.08→ 85 0 265 231 704 ¹¹ 0 265 233 341 ¹⁴		
	2.2 TDCi	04.06→	81/85/96/103			TW	0 265 005 690		
Transit Euroline [E_]									
	2.0i	08.94-09.99	51/56/63/84/85				1 987 476 510 → 430 1 987 476 511 ← 430		
	ABS, 10.99-07.00		51/56/63/84/85				1 987 476 510 → 430 1 987 476 511 ← 430		
	2.5 D	08.94-09.99	51/56/63/84/85				1 987 476 510 → 430 1 987 476 511 ← 430		
	2.5 DI								
	2.5 TD	ABS, 10.99-08.00	51/56/63/84/85				1 987 476 510 → 430 1 987 476 511 ← 430		
	2.5 TDI	OAS							
	2.0i	08.94-08.00	51/56/63/84/85		5LO		0 204 102 925 → 42 0 204 103 925		0 204 104 135 ⁷
	2.5 D								
	2.5 DI						0 204 102 926 ← 42 0 204 103 926		0 204 104 135 ⁷
	2.5 TD								
	2.5 TDI				6LO		0 204 102 934 → 42 0 204 102 935 ← 42		0 204 104 135 ⁷ 0 204 104 135 ⁷
	2.0i	08.94-07.00	51/56/63/84/85		BRV		1 987 476 614 447 1 987 476 615 415		
	ABS, 08.94-07.00		51/56/63/84/85		BRD				
	OAS								
	2.5 D	08.94-08.00	51/56/63/84/85		BRV		1 987 476 614 447 1 987 476 615 415		
	2.5 DI	ABS, 08.94-08.00	51/56/63/84/85		BRD				
	2.5 TD	OAS							
	2.5 TDI								
	2.0i	08.94-08.00	51/56/63/84/85				F 026 002 171 ↔ 20,6 F 026 002 172 ↔ 22,19		
	2.5 D, DI, TD, TDI								
	2.0i	ABO 08.94-03.97	51/56/63/84				F 026 003 136 23,8 F 026 003 354 23,8 ABS 04.97-07.00 51/56/63/84 0 204 123 355 23,8		





FORD Transit Euroline [E_ _]

	2.5 D	ABO	08.94-03.97	51/56/63/84		F 026	003 136	23,8	
	2.5 DI		04.97-08.00	51/56/63/84		F 026	003 354	23,8	
	2.5 TD	ABS	04.97-08.00	51/56/63/84		0 204	123 355	23,8	
	2.5 TDI	ABO	03.99-08.00	85		F 026	003 354	23,8	
		ABS	03.99-08.00	85		0 204	123 355	23,8	
	2.0 i		04.97-07.00	51/56/63/84	LLE	0 204	125 531		
		ABO	08.94-03.97	51/56/63/84	LLE	0 204	125 101		
					LLE,Z9	0 204	125 127		
	2.5 D		04.97-08.00	51/56/63/84	LLE	0 204	125 531		
	2.5 DI	ABO	08.94-03.97	51/56/63/84	LLE	0 204	125 101		
	2.5 TD				LLE,Z9	0 204	125 127		
	2.5 TDI		03.99-08.00	85	LLE	0 204	125 531		
	2.0 i		08.94-07.00	84	Org.Nr. Typ 80,100S,120	BRD	0 204 131 359 ¹⁰		
						BRV	0 204 131 354 ¹⁰		
					Org.Nr. Typ 100L-150L,150S	BRV	0 204 131 356 ¹⁰		
					Org.Nr. Typ 130/150S/150L	BRV	0 204 131 368 ¹⁰		
	2.5 D		08.94-08.00	51/56/63/85	Org.Nr. Typ 80,100S,120	BRD	0 204 131 367 ¹⁰		
	2.5 DI					BRV	0 204 031 299 ¹⁰		
	2.5 TD				Org.Nr. Typ 100L-150L,150S	BRD	0 204 131 360 ¹⁰		
	2.5 TDI					BRV	0 204 031 298 ¹⁰		
	2.0 i		08.94-08.00	51/56/63/84/85		OZB	1 987 477 369	2823	
	2.5 D, DI, TD, TDI					ZWB	1 987 477 370	2730	
	2.0 i		11.97-08.00	51/84			0 265 220 468 ¹⁸		
	2.5 D						0 265 220 468 ¹⁸		
	2.5 DI		11.97-08.00	56			0 265 220 468 ¹⁸		
		ABS, OAS	11.97-08.00	56		AK	0 265 216 625 ¹⁶		
	2.5 TD		11.97-08.00	63/85			0 265 220 468 ¹⁸		
	2.5 TDI								
	2.0 i		11.97-08.00	51/84			1 273 004 260 ¹⁸		
	2.5 D						1 273 004 260 ¹⁸		
	2.5 DI		11.97-08.00	56			1 273 004 260 ¹⁸		
		ABS, OAS	11.97-08.00	56		AK	1 273 004 340 ¹⁶		
	2.5 TD		11.97-08.00	63/85			1 273 004 260 ¹⁸		
	2.5 TDI								

Transit Euroline [F_ _ _]









	2.0 TDCi		08.00-07.03	74/92		1 987	481 045	475	
	2.0 TDE							← 475	
							1 987	481 070	→ 478
			08.03-07.06	74/92			1 987	481 046	410
									← 410
							1 987	481 047	→ 410
	2.0 TDCi		08.00-07.06	74/92		0 204	204 992	← 48	0 204 201 289 ⁸
	2.0 TDE					0 986	473 272	→ 48	0 204 201 476
						0 204	204 993	→ 48	0 204 201 289 ⁸
						0 986	474 272	→ 48	

		S							
	2.0 TDCi 2.0 TDE	08.00-07.06	74/92				1 987 481 072 ¹	375	
	2.0 TDCi 2.0 TDE	08.00-07.06	74/92				F 026 002 578	↔ 25,4	
	2.0 TDCi 2.0 TDE	ABO 08.00-07.06 ABS 08.00-07.06	74/92				0 204 024 070 0 204 024 071	25,4 25,4	
	2.0 TDCi 2.0 TDE	08.00-07.03	74/92			RLE	0 204 024 181		
	2.0 TDCi 2.0 TDE	08.00-07.06 12.02-02.04 12.02-07.06 02.04-07.06	74/92 74/92 74/92 74/92			KZB,KZE KZB,KZW KW2 KZS,KZW KZW,RSA	0 204 131 703 ¹⁰ 0 204 131 702 ¹⁰ 0 204 131 711 ¹⁰ 0 204 131 705 ¹⁰ 0 204 131 710 ¹⁰		
	2.0 TDCi 2.0 TDE	08.00-07.06	74/92				1 987 477 174 1 987 482 036 LLE 1 987 477 186 RLE 1 987 477 190	← 1547 → 1283 1052 910	
	2.0 TDCi 2.0 TDE	08.00-07.06	74/92				0 265 220 539 ¹⁴		
	2.0 TDCi 2.0 TDE	08.00-05.04 08.00-07.06 07.03-07.06 11.03-05.04 05.04-07.06	74/92 74/92 74/92 74/92 74/92			LAB,TW RAB,TW TW LAB,TW TW RAB,TW RAB,TW	0 265 006 818 ⁴ 0 265 006 817 ⁴ 0 265 006 458 ³ 0 265 006 784 ⁴ 0 265 006 784 ³ 0 265 006 460 ⁴ 0 265 006 811 ⁴		
Transit [F_ _ _]									
	FT 240 K/S 2.0 TD FT 240 K/S 2.0 TDE FT 260 K/S 2.0 TD FT 260 K/S 2.0 TDCi FT 260 K/S 2.0 TDE	08.00-07.03	55/63/74/ 92				1 987 481 045 1 987 481 070 1 987 481 046 1 987 481 047	475 ← 475 → 478 410 ← 410 → 410	
	FT 260 K/S 2.3i FT 260 K/S 2.4 TDE	04.01-07.06	66/103-107				1 987 481 045 1 987 481 070	475 ← 475 → 478	
	FT 280 K/S 2.0 TD FT 280 K/S 2.0 TDCi FT 280 K/S 2.0 TDE	08.00-07.03 08.03-07.06	55/63/74/ 92 55/63/74/ 92				1 987 481 045 1 987 481 070 1 987 481 046 1 987 481 047	475 ← 475 → 478 410 ← 410 → 410	











		S							
◀ FORD Transit [F_ _ _]									
FT 280 K/S 2.3i, 2.4 TDE	01.00-07.06	55/66/85/					1987 481 045	475	
FT 280 L 2.3i, 2.4 TDE		92/103-107						← 475	
							1987 481 070	→ 478	
FT 280 M 2.0 TD	08.00-07.03	55/63/74/					1987 481 045	475	
FT 280 M 2.0 TDCi		92						← 475	
FT 280 M 2.0 TDE							1987 481 070	→ 478	
	08.03-07.06	55/63/74/					1987 481 046	410	
		92						← 410	
							1987 481 047	→ 410	
FT 280 M 2.3i	04.01-07.06	66/103-107					1987 481 045	475	
FT 280 M 2.4 TDE								← 475	
							1987 481 070	→ 478	
FT 300 K/S 2.0 TD	08.00-07.03	55/63/74/					1987 481 045	475	
FT 300 K/S 2.0 TDCi		92						← 475	
FT 300 K/S 2.0 TDE							1987 481 070	→ 478	
	08.03-07.06	55/63/74/					1987 481 046	410	
		92						← 410	
							1987 481 047	→ 410	
FT 300 K/S 2.3i	08.00-07.06	107					1987 481 045	475	
								← 475	
							1987 481 070	→ 478	
FT 300 L 2.0 TD	08.00-07.03	55/63/74/					1987 481 045	475	
FT 300 L 2.0 TDCi		92						← 475	
FT 300 L 2.0 TDE							1987 481 070	→ 478	
	08.03-07.06	55/63/74/					1987 481 046	410	
		92						← 410	
							1987 481 047	→ 410	
FT 300 L 2.3i	08.00-07.06	107					1987 481 045	475	
								← 475	
							1987 481 070	→ 478	
FT 300 M 2.0 TD	08.00-07.03	55/63/74/					1987 481 045	475	
FT 300 M 2.0 TDCi		92						← 475	
FT 300 M 2.0 TDE							1987 481 070	→ 478	
	08.03-07.06	55/63/74/					1987 481 046	410	
		92						← 410	
							1987 481 047	→ 410	
FT 300 M 2.3i	08.00-07.06	107					1987 481 045	475	
								← 475	
							1987 481 070	→ 478	
FT 330 K/S 2.0 TDCi	05.02-07.03	92					1987 481 045	475	
								← 475	
							1987 481 070	→ 478	
	08.03-07.06	92					1987 481 046	410	
								← 410	
							1987 481 047	→ 410	
FT 330 K/S 2.0 TDE	08.03-07.06	74					1987 481 046	410	
								← 410	
							1987 481 047	→ 410	
FT 330 K/S 2.3i, 2.4 TD	01.00-07.06	55/66/85/					1987 481 045	475	
FT 330 K/S 2.4 TDCi, 2.4 TDE		88/101/						← 475	
		103-107					1987 481 070	→ 478	
FT 330 K/S 2.4 TDE	01.00-07.06	92					1987 481 045	475	
								← 475	
							1987 481 070	→ 478	
FT 330 L 2.0 TDCi	05.02-07.03	92					1987 481 045	475	
								← 475	
							1987 481 070	→ 478	
	08.03-07.06	92					1987 481 046	410	
								← 410	
							1987 481 047	→ 410	
FT 330 L 2.0 TDE	08.03-07.06	74					1987 481 046	410	
								← 410	
							1987 481 047	→ 410	



		S							
FT 330 L 2.3i, 2.4 TD	01.00-07.06	55/66/85/					1 987 481 045	475	
FT 330 L 2.4 TDCi, 2.4 TDE		88/101/ 103-107						← 475	
							1 987 481 070	→ 478	
FT 330 L 2.4 TDE	01.00-07.06	92					1 987 481 045	475	
								← 475	
							1 987 481 070	→ 478	
FT 330 M 2.0 TDCi	05.02-07.03	92					1 987 481 045	475	
								← 475	
							1 987 481 070	→ 478	
	08.03-07.06	92					1 987 481 046	410	
								← 410	
							1 987 481 047	→ 410	
FT 330 M 2.0 TDE	08.03-07.06	74					1 987 481 046	410	
								← 410	
							1 987 481 047	→ 410	
FT 330 M 2.3i, 2.4 TD	01.00-07.06	55/66/85/					1 987 481 045	475	
FT 330 M 2.4 TDCi, 2.4 TDE		88/101/ 103-107						← 475	
							1 987 481 070	→ 478	
FT 330 M 2.4 TDE	01.00-07.06	92					1 987 481 045	475	
								← 475	
							1 987 481 070	→ 478	
FT 350 EL 2.0 TDCi	05.02-07.03	92					1 987 481 045	475	
								← 475	
							1 987 481 070	→ 478	
	08.03-07.06	92					1 987 481 046	410	
								← 410	
							1 987 481 047	→ 410	
FT 350 EL 2.0 TDE	08.03-07.06	74					1 987 481 046	410	
								← 410	
							1 987 481 047	→ 410	
FT 350 EL 2.3i, 2.4 TD	01.00-07.06	55/66/85/					1 987 481 045	475	
FT 350 EL 2.4 TDCi, 2.4 TDE		101/ 103-107						← 475	
							1 987 481 070	→ 478	
FT 350 EL 2.4 TDE	01.00-07.06	92					1 987 481 045	475	
								← 475	
							1 987 481 070	→ 478	
FT 350 L 2.0 TDCi	05.02-07.03	92					1 987 481 045	475	
								← 475	
							1 987 481 070	→ 478	
	08.03-07.06	92					1 987 481 046	410	
								← 410	
							1 987 481 047	→ 410	
FT 350 L 2.0 TDE	08.03-07.06	74					1 987 481 046	410	
								← 410	
							1 987 481 047	→ 410	
FT 350 L 2.3i, 2.4 TD	01.00-07.06	55/66/85/					1 987 481 045	475	
FT 350 L 2.4 TDCi, 2.4 TDE		88/101/ 103-107						← 475	
							1 987 481 070	→ 478	
FT 350 L 2.4 TDE	01.00-07.06	92					1 987 481 045	475	
								← 475	
							1 987 481 070	→ 478	
FT 350 M 2.0 TDCi	05.02-07.03	92					1 987 481 045	475	
								← 475	
							1 987 481 070	→ 478	
	08.03-07.06	92					1 987 481 046	410	
								← 410	
							1 987 481 047	→ 410	
FT 350 M 2.0 TDE	08.03-07.06	74					1 987 481 046	410	
								← 410	
							1 987 481 047	→ 410	
FT 350 M 2.3i, 2.4 TD	01.00-07.06	55/66/85/					1 987 481 045	475	
FT 350 M 2.4 TDCi, 2.4 TDE		88/92/101/ 103-107						← 475	
							1 987 481 070	→ 478	



◀ FORD Transit [F_...]								
	FT 430 EL 2.4 TD, 2.4 TDCi	08.02-07.06	55/66/85/			1987 481 045	475	
	FT 430 EL 2.4 TDE		88/92/101/				← 475	
	FT 430 M 2.4 TD, 2.4 TDCi		103-107			1987 481 070	→ 478	
	FT 430 M 2.4 TDE							
	FT 240 K/S 2.0 TD, 2.0 TDE	01.00-07.06	55/63/66/			0 204 204 992	← 48	0 204 201 289 ⁸
	FT 260 K/S 2.0 TD, 2.0 TDCi		74/85/88/			0986 473 272		0 204 201 476
	FT 260 K/S 2.0 TDE, 2.3i, 2.4 TDE		92/101/			0 204 204 993	→ 48	0 204 201 289 ⁸
	FT 280 K/S 2.0 TD, 2.0 TDCi		103-107			0986 474 272		
	FT 280 K/S 2.0 TDE, 2.3i							
	FT 280 K/S 2.4 TDE							
	FT 280 L 2.3i, 2.4 TDE							
	FT 280 M 2.0 TD, 2.0 TDCi							
	FT 280 M 2.0 TDE, 2.3i, 2.4 TDE							
	FT 300 K/S 2.0 TD, 2.0 TDCi							
	FT 300 K/S 2.0 TDE, 2.3i							
	FT 300 L 2.0 TD, 2.0 TDCi							
	FT 300 L 2.0 TDE, 2.3i	01.00-07.06	55/63/66/			0 204 204 992	← 48	0 204 201 289 ⁸
	FT 300 M 2.0 TD, 2.0 TDCi		74/85/88/			0986 473 272		0 204 201 476
	FT 300 M 2.0 TDE, 2.3i		92/101/			0 204 204 993	→ 48	0 204 201 289 ⁸
	FT 330 K/S 2.0 TDCi, 2.0 TDE		103-107			0986 474 272		
	FT 330 K/S 2.3i, 2.4 TD							
	FT 330 K/S 2.4 TDCi, 2.4 TDE							
	FT 330 L 2.0 TDCi, 2.0 TDE							
	FT 330 L 2.3i, 2.4 TD							
	FT 330 L 2.4 TDCi, 2.4 TDE							
	FT 330 M 2.0 TDCi, 2.0 TDE, 2.3i							
	FT 330 M 2.4 TD, 2.4 TDCi, 2.4 TDE							
	FT 350 EL 2.0 TDCi							
	FT 350 EL 2.0 TDE, 2.3i, 2.4 TD	01.00-07.06	55/63/66/			0 204 204 992	← 48	0 204 201 289 ⁸
	FT 350 EL 2.4 TDCi, 2.4 TDE		74/85/88/			0986 473 272		0 204 201 476
	FT 350 L 2.0 TDCi, 2.0 TDE		92/101/			0 204 204 993	→ 48	0 204 201 289 ⁸
	FT 350 L 2.3i, 2.4 TD, 2.4 TDCi		103-107			0986 474 272		
	FT 350 L 2.4 TDE							
	FT 350 M 2.0 TDCi, 2.0 TDE							
	FT 350 M 2.3i, 2.4 TD							
	FT 350 M 2.4 TDCi, 2.4 TDE							
	FT 430 EL 2.4 TD, 2.4 TDCi							
	FT 430 EL 2.4 TDE, 2.4 TD							
	FT 430 M 2.4 TDCi, 2.4 TDE							
<hr/>								
	FT 240 K/S 2.0 TD, 2.0 TDE	01.00-07.06	55/63/66/		BUS,KOB,KW	1987 481 072 ¹	375	
	FT 260 K/S 2.0 TD, 2.0 TDCi		74/85/92/		FGS,PW	1987 481 073 ¹	425	
	FT 260 K/S 2.0 TDE, 2.3i		103-107					
	FT 260 K/S 2.4 TDE							
	FT 280 K/S 2.0 TD, 2.0 TDCi							
	FT 280 K/S 2.0 TDE, 2.3i							
	FT 280 K/S 2.4 TDE							
	FT 280 L 2.3i, 2.4 TDE							
	FT 280 M 2.0 TD, 2.0 TDCi							
	FT 280 M 2.0 TDE, 2.3i							
	FT 280 M 2.4 TDE							
	FT 300 K/S 2.0 TD, 2.0 TDCi							
	FT 300 K/S 2.0 TDE, 2.3i							
	FT 300 L 2.0 TD, 2.0 TDCi							
	FT 300 L 2.0 TDE, 2.3i	08.00-07.06	55/63/66/		BUS,KOB,KW	1987 481 072 ¹	375	
	FT 300 M 2.0 TD, 2.0 TDCi		74/85/92/		FGS,PW	1987 481 073 ¹	425	
	FT 300 M 2.0 TDE, 2.3i		103-107					
	FT 330 K/S 2.0 TDCi	05.02-07.06	74/92		BUS,KOB,KW	1987 481 167	407	
	FT 330 K/S 2.0 TDE				FGS,PW	1987 481 166	445	

		S							
FT 330 K/S 2.3i, 2.4 TD	01.00-07.06	55/66/85/88/101/				BUS,KOB,KW	1 987 481 072 ¹	375	
FT 330 K/S 2.4 TDCi, 2.4 TDE		103-107				FGS,PW	1 987 481 073 ¹	425	
FT 330 K/S 2.4 TDE	01.00-07.06	92				BUS,KOB,KW	1 987 481 072 ¹	375	
						FGS,PW	1 987 481 073 ¹	425	
FT 330 L 2.0 TDCi	05.02-07.06	92				BUS,KOB,KW	1 987 481 167	407	
						FGS,PW	1 987 481 166	445	
FT 330 L 2.0 TDE	08.03-07.06	74				BUS,KOB,KW	1 987 481 167	407	
						FGS,PW	1 987 481 166	445	
FT 330 L 2.3i, 2.4 TD	01.00-07.06	55/66/85/88/101/				BUS,KOB,KW	1 987 481 072 ¹	375	
FT 330 L 2.4 TDCi, 2.4 TDE		103-107				FGS,PW	1 987 481 073 ¹	425	
FT 330 L 2.4 TDE	01.00-07.06	92				BUS,KOB,KW	1 987 481 072 ¹	375	
						FGS,PW	1 987 481 073 ¹	425	
FT 330 M 2.0 TDCi	05.02-07.06	92				BUS,KOB,KW	1 987 481 167	407	
						FGS,PW	1 987 481 166	445	
FT 330 M 2.0 TDE	08.03-07.06	74				BUS,KOB,KW	1 987 481 167	407	
						FGS,PW	1 987 481 166	445	
FT 330 M 2.3i, 2.4 TD, 2.4 TDCi	01.00-07.06	55/66/85/88/101/				BUS,KOB,KW	1 987 481 072 ¹	375	
FT 330 M 2.4 TDE		103-107				FGS,PW	1 987 481 073 ¹	425	
FT 330 M 2.4 TDE	01.00-07.06	92				BUS,KOB,KW	1 987 481 072 ¹	375	
						FGS,PW	1 987 481 073 ¹	425	
FT 350 EL 2.0 TDCi	05.02-07.06	92				BUS,KOB,KW	1 987 481 167	407	
						FGS,PW	1 987 481 166	445	
FT 350 EL 2.0 TDE	08.03-07.06	74				BUS,KOB,KW	1 987 481 167	407	
						FGS,PW	1 987 481 166	445	
FT 350 EL 2.3i, 2.4 TD	01.00-07.06	55/66/85/101/				BUS,KOB,KW	1 987 481 072 ¹	375	
FT 350 EL 2.4 TDCi, 2.4 TDE		103-107				FGS,PW	1 987 481 073 ¹	425	
FT 350 EL 2.4 TDE	01.00-07.06	92				BUS,KOB,KW	1 987 481 072 ¹	375	
						FGS,PW	1 987 481 073 ¹	425	
FT 350 L 2.0 TDCi	05.02-07.06	92				BUS,KOB,KW	1 987 481 167	407	
						FGS,PW	1 987 481 166	445	
FT 350 L 2.0 TDE	08.03-07.06	74				BUS,KOB,KW	1 987 481 167	407	
						FGS,PW	1 987 481 166	445	
FT 350 L 2.3i, 2.4 TD	01.00-07.06	55/66/85/88/101/				BUS,KOB,KW	1 987 481 072 ¹	375	
FT 350 L 2.4 TDCi, 2.4 TDE		103-107				FGS,PW	1 987 481 073 ¹	425	
FT 350 L 2.4 TDE	01.00-07.06	92				BUS,KOB,KW	1 987 481 072 ¹	375	
						FGS,PW	1 987 481 073 ¹	425	
FT 350 M 2.0 TDCi	05.02-07.06	92				BUS,KOB,KW	1 987 481 167	407	
						FGS,PW	1 987 481 166	445	
FT 350 M 2.0 TDE	08.03-07.06	74				BUS,KOB,KW	1 987 481 167	407	
						FGS,PW	1 987 481 166	445	
FT 350 M 2.3i, 2.4 TD	01.00-07.06	55/66/85/88/92/101/				BUS,KOB,KW	1 987 481 072 ¹	375	
FT 350 M 2.4 TDCi, 2.4 TDE		103-107				FGS,PW	1 987 481 073 ¹	425	
FT 430 EL 2.4 TD, 2.4 TDCi	08.02-07.06	55/66/85/88/92/101/				BUS,KOB,KW	1 987 481 072 ¹	375	
FT 430 EL 2.4 TDE		103-107				FGS,PW	1 987 481 073 ¹	425	
FT 430 M 2.4 TD, 2.4 TDCi									
FT 430 M 2.4 TDE									
 FT 240 K/S 2.0 TD, 2.0 TDE	01.00-07.06	55/63/66/					F 026 002 578	↔ 25,4	
FT 260 K/S 2.0 TD, 2.0 TDCi		74/85/88/							
FT 260 K/S 2.0 TDE, 2.3i, 2.4 TDE		92/101/							
FT 280 K/S 2.0 TD, 2.0 TDCi		103-107							
FT 280 K/S 2.0 TDE, 2.3i, 2.4 TDE									
FT 280 L 2.3i, 2.4 TDE									
FT 280 M 2.0 TD, 2.0 TDCi									
FT 280 M 2.0 TDE, 2.3i, 2.4 TDE									
FT 300 K/S 2.0 TD, 2.0 TDCi									
FT 300 K/S 2.0 TDE, 2.3i									
FT 300 L 2.0 TD, 2.0 TDCi									













	◀ FORD Transit [F_ _ _]							
	FT 300 L 2.0 TDE, 2.3i		01.00-07.06	55/63/66/		F 026 002 578	↔ 25,4	
	FT 300 M 2.0 TD, 2.0 TDCi			74/85/88/				
	FT 300 M 2.0 TDE, 2.3i			92/101/				
	FT 330 K/S 2.0 TDCi, 2.0 TDE			103-107				
	FT 330 K/S 2.3i, 2.4 TD							
	FT 330 K/S 2.4 TDCi, 2.4 TDE							
	FT 330 L 2.0 TDCi, 2.0 TDE, 2.3i							
	FT 330 L 2.4 TD, 2.4 TDCi, 2.4 TDE							
	FT 330 M 2.0 TDCi, 2.0 TDE, 2.3i							
	FT 330 M 2.4 TD, 2.4 TDCi, 2.4 TDE							
	FT 350 EL 2.0 TDCi							
	FT 350 EL 2.0 TDE, 2.3i, 2.4 TD		01.00-07.06	55/63/66/		F 026 002 578	↔ 25,4	
	FT 350 EL 2.4 TDCi, 2.4 TDE			74/85/88/				
	FT 350 L 2.0 TDCi, 2.0 TDE, 2.3i			92/101/				
	FT 350 L 2.4 TD, 2.4 TDCi, 2.4 TDE			103-107				
	FT 350 M 2.0 TDCi, 2.0 TDE, 2.3i							
	FT 350 M 2.4 TD, 2.4 TDCi, 2.4 TDE							
	FT 430 EL 2.4 TD, 2.4 TDCi, 2.4 TDE							
	FT 430 M 2.4 TD, 2.4 TDCi, 2.4 TDE							



	FT 240 K/S 2.0 TD	ABO	08.00-07.06	55/63/92		0 204 024 070	25,4
	FT 240 K/S 2.0 TDE	ABS	08.00-07.06	55/63/92		0 204 024 071	25,4
	FT 260 K/S 2.0 TD	ABO	08.00-07.06	55/63/92		0 204 024 070	25,4
	FT 260 K/S 2.0 TDCi	ABS	08.00-07.06	55/63/92		0 204 024 071	25,4
	FT 260 K/S 2.0 TDE	ABO	08.00-07.06	63/74		0 204 024 070	25,4
		ABS	08.00-07.06	63/74		0 204 024 071	25,4
	FT 260 K/S 2.3i	ABO	04.01-07.06	55/66/92/103-107		0 204 024 070	25,4
	FT 260 K/S 2.4 TDE	ABS	04.01-07.06	55/66/92/103-107		0 204 024 071	25,4
	FT 280 K/S 2.0 TD	ABO	08.00-07.06	55/66/92/103-107		0 204 024 070	25,4
	FT 280 K/S 2.0 TDCi	ABS	08.00-07.06	55/66/92/103-107		0 204 024 071	25,4
	FT 280 K/S 2.0 TDE	ABO	08.00-07.06	63/74		0 204 024 070	25,4
		ABS	08.00-07.06	63/74		0 204 024 071	25,4
	FT 280 K/S 2.3i	ABO	04.01-07.06	66/103-107		0 204 024 070	25,4
	FT 280 K/S 2.4 TDE	ABS	04.01-07.06	66/103-107		0 204 024 071	25,4
	FT 280 L 2.3i	ABO	08.01-07.06	66/103-107		0 204 024 070	25,4
		ABS	08.01-07.06	66/103-107		0 204 024 071	25,4
	FT 280 L 2.4 TDE	ABO	01.00-07.06	55/66/85/92		0 204 024 070	25,4
		ABS	01.00-07.06	55/66/85/92		0 204 024 071	25,4
	FT 280 M 2.0 TD	ABO	08.00-07.06	55/92		0 204 024 070	25,4
	FT 280 M 2.0 TDCi	ABS	08.00-07.06	55/92		0 204 024 071	25,4
	FT 280 M 2.0 TDE	ABO	08.00-07.06	63/74		0 204 024 070	25,4
		ABS	08.00-07.06	63/74		0 204 024 071	25,4
	FT 280 M 2.3i	ABO	04.01-07.06	55/66/92/103-107		0 204 024 070	25,4
	FT 280 M 2.4 TDE	ABS	04.01-07.06	55/66/92/103-107		0 204 024 071	25,4
	FT 300 K/S 2.0 TD	ABO	08.00-07.06	55/66/92/103-107		0 204 024 070	25,4
	FT 300 K/S 2.0 TDCi	ABS	08.00-07.06	55/66/92/103-107		0 204 024 071	25,4
	FT 300 K/S 2.0 TDE	ABO	08.00-07.06	63/74		0 204 024 070	25,4
		ABS	08.00-07.06	63/74		0 204 024 071	25,4
	FT 300 K/S 2.3i	ABO	08.00-07.06	55/92/107		0 204 024 070	25,4
		ABS	08.00-07.06	55/92/107		0 204 024 071	25,4
	FT 300 L 2.0 TD, 2.0 TDCi	ABO	08.00-07.06	55/92/107		0 204 024 070	25,4
	FT 300 L 2.3i	ABS	08.00-07.06	55/92/107		0 204 024 071	25,4
	FT 300 L 2.0 TDE	ABO	08.00-07.06	63/74		0 204 024 070	25,4
		ABS	08.00-07.06	63/74		0 204 024 071	25,4
	FT 300 M 2.0 TD	ABO	08.00-07.06	55/92/107		0 204 024 070	25,4
	FT 300 M 2.0 TDCi	ABS	08.00-07.06	55/92/107		0 204 024 071	25,4
	FT 300 M 2.0 TDE	ABO	08.00-07.06	63/74		0 204 024 070	25,4
		ABS	08.00-07.06	63/74		0 204 024 071	25,4
	FT 300 M 2.3i	ABO	08.00-07.06	74/92/107		0 204 024 070	25,4
		ABS	08.00-07.06	74/92/107		0 204 024 071	25,4

		S							
FT 330 K/S 2.0 TDCi	ABO	05.02-07.06	74/92/107				0 204 024 070	25,4	
FT 330 K/S 2.0 TDE	ABS	05.02-07.06	74/92/107				0 204 024 071	25,4	
FT 330 K/S 2.3i	ABO	12.00-07.06	103-107				0 204 024 070	25,4	
	ABS	12.00-07.06	103-107				0 204 024 071	25,4	
FT 330 K/S 2.4 TD	ABO	01.00-09.03	55				0 204 024 070	25,4	
	ABS	01.00-09.03	55				0 204 024 071	25,4	
FT 330 K/S 2.4 TDCi	ABO	03.04-07.06	101				0 204 024 070	25,4	
	ABS	03.04-07.06	101				0 204 024 071	25,4	
FT 330 K/S 2.4 TDE	ABO	01.00-07.06	66/85/88/92				0 204 024 070	25,4	
	ABS	01.00-07.06	66/85/88				0 204 024 071	25,4	
			92				0 204 024 071	25,4	
FT 330 L 2.0 TDCi	ABO	05.02-07.06	92				0 204 024 070	25,4	
FT 330 L 2.0 TDCi, 2.4 TDE	ABS	01.00-07.06	92				0 204 024 071	25,4	
FT 330 L 2.0 TDE	ABO	08.03-07.06	74				0 204 024 070	25,4	
	ABS	08.03-07.06	74				0 204 024 071	25,4	
FT 330 L 2.3i	ABO	12.00-07.06	103-107				0 204 024 070	25,4	
	ABS	12.00-07.06	103-107				0 204 024 071	25,4	
FT 330 L 2.4 TD	ABO	01.00-09.03	55				0 204 024 070	25,4	
	ABS	01.00-09.03	55				0 204 024 071	25,4	
FT 330 L 2.4 TDCi	ABO	03.04-07.06	101				0 204 024 070	25,4	
	ABS	03.04-07.06	101				0 204 024 071	25,4	
FT 330 L 2.4 TDE	ABO	01.00-07.06	66/85/88/92				0 204 024 070	25,4	
	ABS	01.00-07.06	66/85/88				0 204 024 071	25,4	
FT 330 M 2.0 TDCi	ABO	05.02-07.06	92				0 204 024 070	25,4	
FT 330 M 2.0 TDCi, 2.4 TDE	ABS	01.00-07.06	92				0 204 024 071	25,4	
FT 330 M 2.0 TDE	ABO	08.03-07.06	74				0 204 024 070	25,4	
	ABS	08.03-07.06	74				0 204 024 071	25,4	
FT 330 M 2.3i	ABO	12.00-07.06	103-107				0 204 024 070	25,4	
	ABS	12.00-07.06	103-107				0 204 024 071	25,4	
FT 330 M 2.4 TD	ABO	01.00-09.03	55				0 204 024 070	25,4	
	ABS	01.00-09.03	55				0 204 024 071	25,4	
FT 330 M 2.4 TDCi	ABO	03.04-07.06	101				0 204 024 070	25,4	
	ABS	03.04-07.06	101				0 204 024 071	25,4	
FT 330 M 2.4 TDE	ABO	01.00-07.06	66/85/88/92				0 204 024 070	25,4	
	ABS	01.00-07.06	66/85/88				0 204 024 071	25,4	
FT 350 EL 2.0 TDCi	ABO	05.02-07.06	92				0 204 024 070	25,4	
FT 350 EL 2.0 TDCi, 2.4 TDE	ABS	01.00-07.06	92				0 204 024 071	25,4	
FT 350 EL 2.0 TDE	ABO	08.03-07.06	74				0 204 024 070	25,4	
	ABS	08.03-07.06	74				0 204 024 071	25,4	
FT 350 EL 2.3i	ABO	12.00-07.06	103-107				0 204 024 070	25,4	
	ABS	12.00-07.06	103-107				0 204 024 071	25,4	
FT 350 EL 2.4 TD	ABO	01.00-09.03	55				0 204 024 070	25,4	
	ABS	01.00-09.03	55				0 204 024 071	25,4	
FT 350 EL 2.4 TDCi	ABO	03.04-07.06	101				0 204 024 070	25,4	
	ABS	03.04-07.06	101				0 204 024 071	25,4	
FT 350 EL 2.4 TDE	ABO	01.00-07.06	66/85/92				0 204 024 070	25,4	
	ABS	01.00-07.06	66/85				0 204 024 071	25,4	
FT 350 L 2.0 TDCi	ABO	05.02-07.06	92				0 204 024 070	25,4	
FT 350 L 2.0 TDCi, 2.4 TDE	ABS	01.00-07.06	92				0 204 024 071	25,4	
FT 350 L 2.0 TDE	ABO	08.03-07.06	74				0 204 024 070	25,4	
	ABS	08.03-07.06	74				0 204 024 071	25,4	
FT 350 L 2.3i	ABO	12.00-07.06	103-107				0 204 024 070	25,4	
	ABS	12.00-07.06	103-107				0 204 024 071	25,4	
FT 350 L 2.4 TD	ABO	01.00-09.03	55				0 204 024 070	25,4	
	ABS	01.00-09.03	55				0 204 024 071	25,4	
FT 350 L 2.4 TDCi	ABO	03.04-07.06	101				0 204 024 070	25,4	
	ABS	03.04-07.06	101				0 204 024 071	25,4	
FT 350 L 2.4 TDE	ABO	01.00-07.06	66/85/88/92				0 204 024 070	25,4	
	ABS	01.00-07.06	66/85/88				0 204 024 071	25,4	
FT 350 M 2.0 TDCi	ABO	05.02-07.06	92				0 204 024 070	25,4	
	ABS	05.02-07.06	92				0 204 024 071	25,4	
FT 350 M 2.0 TDE	ABO	08.03-07.06	74				0 204 024 070	25,4	
	ABS	08.03-07.06	74				0 204 024 071	25,4	













◀ FORD Transit [F_ _ _]						
FT 350 M 2.3i	ABO	12.00-07.06	103-107			0 204 024 070 25,4
	ABS	12.00-07.06	103-107			0 204 024 071 25,4
FT 350 M 2.4 TD	ABO	01.00-09.03	55			0 204 024 070 25,4
	ABS	01.00-09.03	55			0 204 024 071 25,4
FT 350 M 2.4 TDCi	ABO	03.04-07.06	101			0 204 024 070 25,4
	ABS	03.04-07.06	101			0 204 024 071 25,4
FT 350 M 2.4 TDE	ABO	01.00-07.06	66/85/88/92			0 204 024 070 25,4
	ABS	01.00-07.06	66/85/88/92			0 204 024 071 25,4
FT 430 EL 2.4 TD	ABO	08.02-09.03	55			0 204 024 070 25,4
	ABS	08.02-09.03	55			0 204 024 071 25,4
FT 430 EL 2.4 TDCi	ABO	03.04-07.06	101			0 204 024 070 25,4
	ABS	03.04-07.06	101			0 204 024 071 25,4
FT 430 EL 2.4 TDE	ABO	08.02-07.06	66/85/92			0 204 024 070 25,4
	ABS	08.02-07.06	66/85/92			0 204 024 071 25,4
FT 430 M 2.4 TD	ABO	08.02-09.03	55			0 204 024 070 25,4
	ABS	08.02-09.03	55			0 204 024 071 25,4
FT 430 M 2.4 TDCi	ABO	03.04-07.06	101			0 204 024 070 25,4
	ABS	03.04-07.06	101			0 204 024 071 25,4
FT 430 M 2.4 TDE	ABO	08.02-07.06	85/92			0 204 024 070 25,4
	ABS	08.02-07.06	85/92			0 204 024 071 25,4

 F	FT 240 K/S 2.0 TD, 2.0 TDE	08.00-07.03	55/63/74/	RLE	0 204 024 181
	FT 260 K/S 2.0 TD, 2.0 TDCi		92		
	FT 260 K/S 2.0 TDE				
	FT 280 K/S 2.0 TD, 2.0 TDCi				
	FT 280 K/S 2.0 TDE				
	FT 280 M 2.0 TD, 2.0 TDCi				
	FT 280 M 2.0 TDE				
	FT 300 K/S 2.0 TD, 2.0 TDCi				
	FT 300 K/S 2.0 TDE				
	FT 300 L 2.0 TD, 2.0 TDCi	08.00-07.03	55/63/74/92	BDM, RLE	0 204 024 181
	FT 300 L 2.0 TDE	07.03-07.06	55/63/74/92	BDM	0 204 024 692
	FT 300 M 2.0 TD, 2.0 TDCi	08.00-07.03	55/63/74/	RLE	0 204 024 181
	FT 300 M 2.0 TDE		92		
	FT 330 K/S 2.0 TDCi	05.02-07.03	92	RLE	0 204 024 181
	FT 330 L 2.0 TDCi				
FT 330 M 2.0 TDCi					
FT 350 EL 2.0 TDCi	05.02-07.03	92	BDM, RLE	0 204 024 181	
	07.03-07.06	92	BDM	0 204 024 692	
FT 350 EL 2.0 TDE	08.03-07.06	74	BDM	0 204 024 692	
FT 350 L 2.0 TDCi	05.02-07.03	92	BDM, RLE	0 204 024 181	
	07.03-07.06	92	BDM	0 204 024 692	
FT 350 L 2.0 TDE	08.03-07.06	74	BDM	0 204 024 692	
FT 350 M 2.0 TDCi	05.02-07.03	92	RLE	0 204 024 181	









 F	FT 240 K/S 2.0 TD	08.00-07.06	55/63	KZB, RSA	0 204 131 707 ¹⁰
	FT 240 K/S 2.0 TDE	12.02-07.06	55/63	KZB, KZE	0 204 131 703 ¹⁰
				KZS, KZW	0 204 131 705 ¹⁰
		02.04-07.06	55/63	KZW, RSA	0 204 131 710 ¹⁰
	FT 260 K/S 2.0 TD	08.00-07.06	55/63	KZB, RSA	0 204 131 707 ¹⁰
		12.02-02.04	55/63/74/92	KZS, KZW	0 204 131 705 ¹⁰
		12.02-07.06	55/63	KZB, KZE	0 204 131 703 ¹⁰
		02.04-07.06	55/63/74/92	KZW, RSA	0 204 131 710 ¹⁰
	FT 260 K/S 2.0 TDCi	08.00-07.06	55/63/74/92	KZB, RSA	0 204 131 707 ¹⁰
	FT 260 K/S 2.0 TDE	12.02-02.04	55/63/74/92	KZS, KZW	0 204 131 705 ¹⁰
		12.02-07.06	55/63/74/92	KZB, KZE	0 204 131 703 ¹⁰
		02.04-07.06	55/63/74/92	KZW, RSA	0 204 131 710 ¹⁰
	FT 260 K/S 2.3i	12.02-02.04	66/103-107	KZB, KZE	0 204 131 703 ¹⁰
	FT 260 K/S 2.4 TDE	12.02-07.06	66/103-107	KZG, KZW	0 204 131 706 ¹⁰

		S							
FT 280 K/S 2.0 TD	08.00-07.06	55/63/74/92				KZB,KZE	0 204 131 703 ¹⁰		
FT 280 K/S 2.0 TDCi						KZB,RSA	0 204 131 707 ¹⁰		
FT 280 K/S 2.0 TDE	12.02-02.04	55/63/74/92				KZS,KZW	0 204 131 705 ¹⁰		
	12.02-07.06	55/63/74/92				KZB,KZW	0 204 131 702 ¹⁰		
	02.04-07.06	55/63/74/92				KZW,RSA	0 204 131 710 ¹⁰		
FT 280 K/S 2.3i	04.01-07.06	66/103-107				KZB,KZE	0 204 131 703 ¹⁰		
FT 280 K/S 2.4 TDE						KZG,KZW	0 204 131 706 ¹⁰		
	12.02-07.06	66/103-107				KZW,ORA	0 204 131 704 ¹⁰		
FT 280 L 2.3i	01.00-07.06	55/66/85/				KB2	0 204 131 701 ¹⁰		
FT 280 L 2.4 TDE		92/103-107				KW2	0 204 131 711 ¹⁰		
						KZB,KZE	0 204 131 703 ¹⁰		
						KZB,KZW	0 204 131 702 ¹⁰		
						KZB,RSA	0 204 131 707 ¹⁰		
						KZG,KZW	0 204 131 706 ¹⁰		
						KZS,KZW	0 204 131 705 ¹⁰		
						KZW,RSA	0 204 131 710 ¹⁰		
	12.02-07.06	55/66/85/92/103-107				KZW,ORA	0 204 131 704 ¹⁰		
FT 280 M 2.0 TD	08.00-12.02	55/63/74/92				KB2	0 204 131 701 ¹⁰		
FT 280 M 2.0 TDCi	12.02-02.04	55/63/74/92				KZS,KZW	0 204 131 705 ¹⁰		
FT 280 M 2.0 TDE	12.02-07.06	55/63/74/92				KZB,KZE	0 204 131 703 ¹⁰		
						KZB,KZW	0 204 131 702 ¹⁰		
	02.04-07.06	55/63/74/92				KZW,RSA	0 204 131 710 ¹⁰		
FT 280 M 2.3i	04.01-07.06	66/103-107				KZB,KZE	0 204 131 703 ¹⁰		
FT 280 M 2.4 TDE	12.02-07.06	66/103-107				KZG,KZW	0 204 131 706 ¹⁰		
						KZW,ORA	0 204 131 704 ¹⁰		
FT 300 K/S 2.0 TD	08.00-07.06	55/63/74/92				KZB,KZE	0 204 131 703 ¹⁰		
FT 300 K/S 2.0 TDCi	12.02-02.04	55/63/74/92				KZS,KZW	0 204 131 705 ¹⁰		
FT 300 K/S 2.0 TDE	12.02-07.06	55/63/74/92				KW2	0 204 131 711 ¹⁰		
						KZW,ORA	0 204 131 704 ¹⁰		
	02.04-07.06	55/63/74/92				KZW,RSA	0 204 131 710 ¹⁰		
FT 300 K/S 2.3i	08.00-07.06	107				KW2	0 204 131 711 ¹⁰		
						KZG,KZW	0 204 131 706 ¹⁰		
	12.02-07.06	107				KZB,KZE	0 204 131 703 ¹⁰		
FT 300 L 2.0 TD	08.00-07.06	55/63/74/92				KZB,KZE	0 204 131 703 ¹⁰		
FT 300 L 2.0 TDCi	12.02-02.04	55/63/74/92				KZS,KZW	0 204 131 705 ¹⁰		
FT 300 L 2.0 TDE	02.04-07.06	55/63/74/92				KZW,RSA	0 204 131 710 ¹⁰		
FT 300 L 2.3i	08.00-12.02	107				KZB,KZW	0 204 131 702 ¹⁰		
	12.02-07.06	107				KZB,KZE	0 204 131 703 ¹⁰		
						KZB,RSA	0 204 131 707 ¹⁰		
						KZG,KZW	0 204 131 706 ¹⁰		
						KZW,ORA	0 204 131 704 ¹⁰		
FT 300 M 2.0 TD	08.00-07.06	55/63/74/92				KZB,KZE	0 204 131 703 ¹⁰		
FT 300 M 2.0 TDCi	12.02-02.04	55/63/74/92				KZS,KZW	0 204 131 705 ¹⁰		
FT 300 M 2.0 TDE	12.02-07.06	55/63/74/92				KZW,ORA	0 204 131 704 ¹⁰		
						KZW,RSA	0 204 131 710 ¹⁰		
FT 300 M 2.3i	08.00-07.06	107				KZB,KZW	0 204 131 702 ¹⁰		
						KZG,KZW	0 204 131 706 ¹⁰		
	12.02-02.04	107				KZS,KZW	0 204 131 705 ¹⁰		
	12.02-07.06	107				KZB,KZE	0 204 131 703 ¹⁰		
						KZW,ORA	0 204 131 704 ¹⁰		
FT 330 K/S 2.0 TDCi	05.02-07.06	74/92				KZB,KZE	0 204 131 703 ¹⁰		
FT 330 K/S 2.0 TDE	12.02-02.04	74/92				KZS,KZW	0 204 131 705 ¹⁰		
	12.02-07.06	74/92				KZW,ORA	0 204 131 704 ¹⁰		
						KZW,RSA	0 204 131 710 ¹⁰		
FT 330 K/S 2.3i	01.00-07.06	55/103-107				KB2	0 204 131 701 ¹⁰		
FT 330 K/S 2.4 TD						KZA,KZW	0 204 131 708 ¹⁰		
						KZW,ORA	0 204 131 704 ¹⁰		
	12.02-02.04	55/103-107				KZW,RSA	0 204 131 710 ¹⁰		
	12.02-07.06	55/103-107				KZB,KZE	0 204 131 703 ¹⁰		
						KZG,KZW	0 204 131 706 ¹⁰		











		S							
◀ FORD Transit [F_...]									
FT 330 K/S 2.4 TDCi	03.04-07.06	101		KB2	0 204 131 701 ¹⁰				
				KZA,KZW	0 204 131 708 ¹⁰				
				KZB,KZE	0 204 131 703 ¹⁰				
				KZG,KZW	0 204 131 706 ¹⁰				
				KZW,ORA	0 204 131 704 ¹⁰				
FT 330 K/S 2.4 TDE	01.00-07.06	66		KB2	0 204 131 701 ¹⁰				
				KZA,KZW	0 204 131 708 ¹⁰				
				KZW,ORA	0 204 131 704 ¹⁰				
		88		KB2	0 204 131 701 ¹⁰				
				KZA,KZW	0 204 131 708 ¹⁰				
				KZW,ORA	0 204 131 704 ¹⁰				
		92		KB2	0 204 131 701 ¹⁰				
				KZA,KZW	0 204 131 708 ¹⁰				
				KZW,ORA	0 204 131 704 ¹⁰				
	12.02-02.04	66		KZW,RSA	0 204 131 710 ¹⁰				
		88		KZW,RSA	0 204 131 710 ¹⁰				
		92		KZW,RSA	0 204 131 710 ¹⁰				
	12.02-07.06	66		KZB,KZE	0 204 131 703 ¹⁰				
				KZG,KZW	0 204 131 706 ¹⁰				
		88		KZB,KZE	0 204 131 703 ¹⁰				
			KZG,KZW	0 204 131 706 ¹⁰					
	92		KZB,KZE	0 204 131 703 ¹⁰					
			KZG,KZW	0 204 131 706 ¹⁰					
03.04-07.06	85		KB2	0 204 131 701 ¹⁰					
			KZA,KZW	0 204 131 708 ¹⁰					
			KZB,KZE	0 204 131 703 ¹⁰					
			KZG,KZW	0 204 131 706 ¹⁰					
			KZW,ORA	0 204 131 704 ¹⁰					
FT 330 L 2.0 TDCi	05.02-07.06	92		KZB,KZE	0 204 131 703 ¹⁰				
	12.02-02.04	92		KZS,KZW	0 204 131 705 ¹⁰				
	12.02-07.06	92		KZA,KZW	0 204 131 708 ¹⁰				
				KZW,ORA	0 204 131 704 ¹⁰				
	02.04-07.06	92		KZW,RSA	0 204 131 710 ¹⁰				
FT 330 L 2.0 TDE	08.03-02.04	74		KZS,KZW	0 204 131 705 ¹⁰				
	08.03-07.06	74		KZA,KZW	0 204 131 708 ¹⁰				
				KZB,KZE	0 204 131 703 ¹⁰				
			KZW,ORA	0 204 131 704 ¹⁰					
02.04-07.06	74		KZW,RSA	0 204 131 710 ¹⁰					
FT 330 L 2.3i	01.00-12.02	55/103-107		KZS,KZW	0 204 131 705 ¹⁰				
	FT 330 L 2.4 TD	01.00-07.06	55/103-107	KW2	0 204 131 711 ¹⁰				
				KZB,KZE	0 204 131 703 ¹⁰				
12.02-07.06		55/103-107		KZG,KZW	0 204 131 706 ¹⁰				
			KZW,ORA	0 204 131 704 ¹⁰					
FT 330 L 2.4 TDCi	03.04-07.06	101		KW2	0 204 131 711 ¹⁰				
				KZB,KZE	0 204 131 703 ¹⁰				
				KZG,KZW	0 204 131 706 ¹⁰				
				KZW,ORA	0 204 131 704 ¹⁰				
						KZW,ORA	0 204 131 704 ¹⁰		
FT 330 L 2.4 TDE	01.00-12.02	66		KZS,KZW	0 204 131 705 ¹⁰				
				88		KZS,KZW	0 204 131 705 ¹⁰		
				92		KZS,KZW	0 204 131 705 ¹⁰		
	01.00-07.06	66		KW2	0 204 131 711 ¹⁰				
				88		KZB,KZE	0 204 131 703 ¹⁰		
				92		KW2	0 204 131 711 ¹⁰		
				KZB,KZE	0 204 131 703 ¹⁰				
				KZB,KZE	0 204 131 703 ¹⁰				
		92		KW2	0 204 131 711 ¹⁰				
				KZB,KZE	0 204 131 703 ¹⁰				
	12.02-07.06	66		KZG,KZW	0 204 131 706 ¹⁰				
				KZW,ORA	0 204 131 704 ¹⁰				
	88		KZG,KZW	0 204 131 706 ¹⁰					
			KZW,ORA	0 204 131 704 ¹⁰					
	92		KZG,KZW	0 204 131 706 ¹⁰					
			KZW,ORA	0 204 131 704 ¹⁰					











		S								
FT 330 L 2.4 TDE	03.04-07.06	85				KW2	0 204 131 711 ¹⁰			
						KZB,KZE	0 204 131 703 ¹⁰			
						KZG,KZW	0 204 131 706 ¹⁰			
						KZW,ORA	0 204 131 704 ¹⁰			
FT 330 M 2.0 TDCi	05.02-07.06	92				KZB,KZE	0 204 131 703 ¹⁰			
	12.02-02.04	92				KZS,KZW	0 204 131 705 ¹⁰			
	12.02-07.06	92				KZA,KZW	0 204 131 708 ¹⁰			
						KZW,ORA	0 204 131 704 ¹⁰			
	02.04-07.06	92				KZW,RSA	0 204 131 710 ¹⁰			
FT 330 M 2.0 TDE	08.03-02.04	74				KZS,KZW	0 204 131 705 ¹⁰			
	08.03-07.06	74				KZA,KZW	0 204 131 708 ¹⁰			
						KZB,KZE	0 204 131 703 ¹⁰			
						KZW,ORA	0 204 131 704 ¹⁰			
	02.04-07.06	74				KZW,RSA	0 204 131 710 ¹⁰			
FT 330 M 2.3i	01.00-02.04	55/103-107				KZS,KZW	0 204 131 705 ¹⁰			
FT 330 M 2.4 TD	01.00-07.06	55/103-107				KZB,KZE	0 204 131 703 ¹⁰			
						KZW,ORA	0 204 131 704 ¹⁰			
	12.02-07.06	55/103-107				KZG,KZW	0 204 131 706 ¹⁰			
FT 330 M 2.4 TDCi	03.04-07.06	101				KZB,KZE	0 204 131 703 ¹⁰			
						KZG,KZW	0 204 131 706 ¹⁰			
						KZW,ORA	0 204 131 704 ¹⁰			
FT 330 M 2.4 TDE	01.00-02.04	66				KZS,KZW	0 204 131 705 ¹⁰			
		88				KZS,KZW	0 204 131 705 ¹⁰			
		92				KZS,KZW	0 204 131 705 ¹⁰			
	01.00-07.06	66				KZB,KZE	0 204 131 703 ¹⁰			
						KZW,ORA	0 204 131 704 ¹⁰			
		88				KZB,KZE	0 204 131 703 ¹⁰			
						KZW,ORA	0 204 131 704 ¹⁰			
		92				KZB,KZE	0 204 131 703 ¹⁰			
						KZW,ORA	0 204 131 704 ¹⁰			
	12.02-07.06	66				KZG,KZW	0 204 131 706 ¹⁰			
		88				KZG,KZW	0 204 131 706 ¹⁰			
		92				KZG,KZW	0 204 131 706 ¹⁰			
03.04-07.06	85					KZB,KZE	0 204 131 703 ¹⁰			
						KZG,KZW	0 204 131 706 ¹⁰			
						KZW,ORA	0 204 131 704 ¹⁰			
FT 350 EL 2.0 TDCi	05.02-07.06	92				KZB,KZE	0 204 131 703 ¹⁰			
						KZW,ORA	0 204 131 704 ¹⁰			
	12.02-02.04	92				KZS,KZW	0 204 131 705 ¹⁰			
	02.04-07.06	92				KZW,RSA	0 204 131 710 ¹⁰			
FT 350 EL 2.0 TDE	08.03-02.04	74				KZS,KZW	0 204 131 705 ¹⁰			
	08.03-07.06	74				KZB,KZE	0 204 131 703 ¹⁰			
						KZW,ORA	0 204 131 704 ¹⁰			
	02.04-07.06	74				KZW,RSA	0 204 131 710 ¹⁰			
FT 350 EL 2.3i	01.00-12.02	55/103-107				KW2	0 204 131 711 ¹⁰			
FT 350 EL 2.4 TD						KZW,RSA	0 204 131 710 ¹⁰			
	01.00-02.04	55/103-107				KZS,KZW	0 204 131 705 ¹⁰			
	01.00-07.06	55/103-107				KZB,KZE	0 204 131 703 ¹⁰			
	12.02-07.06	55/103-107				KZG,KZW	0 204 131 706 ¹⁰			
						KZW,ORA	0 204 131 704 ¹⁰			
FT 350 EL 2.4 TDCi	03.04-07.06	101				KZB,KZE	0 204 131 703 ¹⁰			
						KZG,KZW	0 204 131 706 ¹⁰			
						KZW,ORA	0 204 131 704 ¹⁰			
FT 350 EL 2.4 TDE	01.00-12.02	66				KW2	0 204 131 711 ¹⁰			
						KZW,RSA	0 204 131 710 ¹⁰			
		92				KW2	0 204 131 711 ¹⁰			
						KZW,RSA	0 204 131 710 ¹⁰			
	01.00-02.04	66				KZS,KZW	0 204 131 705 ¹⁰			
		92				KZS,KZW	0 204 131 705 ¹⁰			
	01.00-07.06	66				KZB,KZE	0 204 131 703 ¹⁰			
							KZB,KZE	0 204 131 703 ¹⁰		
		92					KZB,KZE	0 204 131 703 ¹⁰		



		S								
 ◀ FORD Transit [F_ _ _]										
FT 350 EL 2.4 TDE	12.02-07.06	66				KZG,KZW	0 204 131 706 ¹⁰			
						KZW,ORA	0 204 131 704 ¹⁰			
		92					KZG,KZW	0 204 131 706 ¹⁰		
							KZW,ORA	0 204 131 704 ¹⁰		
	03.04-07.06	85					KZB,KZE	0 204 131 703 ¹⁰		
							KZG,KZW	0 204 131 706 ¹⁰		
KZW,ORA							0 204 131 704 ¹⁰			
FT 350 L 2.0 TDCi	05.02-07.06	92				KZA,KZE	0 204 131 709 ¹⁰			
						KZA,KZW	0 204 131 708 ¹⁰			
	12.02-02.04	92					KZS,KZW	0 204 131 705 ¹⁰		
							KZB,KZE	0 204 131 703 ¹⁰		
	12.02-07.06	92					KZW,ORA	0 204 131 704 ¹⁰		
							KZW,RSA	0 204 131 710 ¹⁰		
KB2							0 204 131 701 ¹⁰			
FT 350 L 2.0 TDE	08.03-02.04	74				KZA,KZW	0 204 131 708 ¹⁰			
						KZS,KZW	0 204 131 705 ¹⁰			
	08.03-07.06	74					KB2	0 204 131 701 ¹⁰		
							KZA,KZE	0 204 131 709 ¹⁰		
							KZB,KZE	0 204 131 703 ¹⁰		
							KZW,ORA	0 204 131 704 ¹⁰		
FT 350 L 2.3i FT 350 L 2.4 TD	01.00-12.02	55/103-107				KW2	0 204 131 711 ¹⁰			
						KZW,RSA	0 204 131 710 ¹⁰			
	01.00-07.06	55/103-107					KZA,KZE	0 204 131 709 ¹⁰		
							KZB,KZE	0 204 131 703 ¹⁰		
	12.02-07.06	55/103-107					KZW,ORA	0 204 131 704 ¹⁰		
							KZG,KZW	0 204 131 706 ¹⁰		
FT 350 L 2.4 TDCi	03.04-07.06	101				KZA,KZE	0 204 131 709 ¹⁰			
						KZB,KZE	0 204 131 703 ¹⁰			
	03.04-07.06	101					KZG,KZW	0 204 131 706 ¹⁰		
							KZS,KZW	0 204 131 705 ¹⁰		
							KZW,ORA	0 204 131 704 ¹⁰		
							KW2	0 204 131 711 ¹⁰		
FT 350 L 2.4 TDE	01.00-12.02	66				KZW,RSA	0 204 131 710 ¹⁰			
						KW2	0 204 131 711 ¹⁰			
		88/92					KW2	0 204 131 711 ¹⁰		
							KZW,RSA	0 204 131 710 ¹⁰		
	01.00-07.06	66					KZA,KZE	0 204 131 709 ¹⁰		
							KZB,KZE	0 204 131 703 ¹⁰		
							KZW,ORA	0 204 131 704 ¹⁰		
							KZA,KZE	0 204 131 709 ¹⁰		
	01.00-07.06	66					KZB,KZE	0 204 131 703 ¹⁰		
							KZW,ORA	0 204 131 704 ¹⁰		
							KZA,KZE	0 204 131 709 ¹⁰		
							KZB,KZE	0 204 131 703 ¹⁰		
	12.02-07.06	66					KZW,ORA	0 204 131 704 ¹⁰		
							KZG,KZW	0 204 131 706 ¹⁰		
							KZS,KZW	0 204 131 705 ¹⁰		
							KZG,KZW	0 204 131 706 ¹⁰		
	12.02-07.06	66					KZS,KZW	0 204 131 705 ¹⁰		
							KZS,KZW	0 204 131 705 ¹⁰		
12.02-07.06	88/92					KZS,KZW	0 204 131 705 ¹⁰			
						KZS,KZW	0 204 131 705 ¹⁰			
03.04-07.06	85					KZA,KZE	0 204 131 709 ¹⁰			
						KZB,KZE	0 204 131 703 ¹⁰			
						KZG,KZW	0 204 131 706 ¹⁰			
						KZS,KZW	0 204 131 705 ¹⁰			
						KZW,ORA	0 204 131 704 ¹⁰			
						KZB,KZE	0 204 131 703 ¹⁰			
FT 350 M 2.0 TDCi	05.02-07.06	88/92				KZB,KZE	0 204 131 703 ¹⁰			
						KZS,KZW	0 204 131 705 ¹⁰			
	05.02-07.06	92					KZW,ORA	0 204 131 704 ¹⁰		
							KZW,RSA	0 204 131 710 ¹⁰		
	02.04-07.06	92					KZB,KZE	0 204 131 703 ¹⁰		
							KZS,KZW	0 204 131 705 ¹⁰		
FT 350 M 2.0 TDE	08.03-07.06	74				KZB,KZE	0 204 131 703 ¹⁰			
						KZS,KZW	0 204 131 705 ¹⁰			
	08.03-07.06	74					KZW,ORA	0 204 131 704 ¹⁰		
							KZW,RSA	0 204 131 710 ¹⁰		
	02.04-07.06	74					KZB,KZE	0 204 131 703 ¹⁰		
							KZS,KZW	0 204 131 705 ¹⁰		











		S							
FT 350 M 2.3i		01.00-02.04	55/103-107			KW2	0 204 131 711 ¹⁰		
FT 350 M 2.4 TD						KZS,KZW	0 204 131 705 ¹⁰		
		01.00-07.06	55/103-107			KZB,KZE	0 204 131 703 ¹⁰		
		12.02-07.06	55/103-107			KZG,KZW	0 204 131 706 ¹⁰		
						KZW,ORA	0 204 131 704 ¹⁰		
FT 350 M 2.4 TDCi		03.04-07.06	101			KZB,KZE	0 204 131 703 ¹⁰		
						KZG,KZW	0 204 131 706 ¹⁰		
						KZW,ORA	0 204 131 704 ¹⁰		
FT 350 M 2.4 TDE		01.00-02.04	66			KW2	0 204 131 711 ¹⁰		
						KZS,KZW	0 204 131 705 ¹⁰		
			88/92			KW2	0 204 131 711 ¹⁰		
						KZS,KZW	0 204 131 705 ¹⁰		
		01.00-07.06	66			KZB,KZE	0 204 131 703 ¹⁰		
			88/92			KZB,KZE	0 204 131 703 ¹⁰		
		12.02-07.06	66			KZG,KZW	0 204 131 706 ¹⁰		
						KZW,ORA	0 204 131 704 ¹⁰		
			88/92			KZG,KZW	0 204 131 706 ¹⁰		
						KZW,ORA	0 204 131 704 ¹⁰		
		03.04-07.06	85			KZB,KZE	0 204 131 703 ¹⁰		
						KZG,KZW	0 204 131 706 ¹⁰		
						KZW,ORA	0 204 131 704 ¹⁰		
FT 430 EL 2.4 TD, 2.4 TDCi		08.02-07.06	55/66/85/			KZB,KZE	0 204 131 703 ¹⁰		
FT 430 EL 2.4 TDE			92/101			KZW,ORA	0 204 131 704 ¹⁰		
FT 430 M 2.4 TD, 2.4 TDCi		12.02-07.06	55/66/85/			KZG,KZW	0 204 131 706 ¹⁰		
FT 430 M 2.4 TDE			92/101						
 FT 240 K/S 2.0 TD		08.00-07.06	55/63/74/			FGS,PW	1 987 482 035	← 1648	
FT 240 K/S 2.0 TDE			92				1 987 482 135	→ 1463	
FT 260 K/S 2.0 TD						LLE	1 987 477 186	1052	
FT 260 K/S 2.0 TDCi						PW	1 987 477 174	← 1547	
FT 260 K/S 2.0 TDE							1 987 482 036	→ 1283	
						RLE	1 987 477 190	910	
FT 260 K/S 2.3i		04.01-07.06	66/103-107			LLE	1 987 477 186	1052	
FT 260 K/S 2.4 TDE						PW	1 987 477 178	← 1528	
							1 987 482 036	→ 1283	
						OZB,PW	1 987 477 180	← 1608	
							1 987 477 185	→ 1386	
						PW,ZWB	1 987 477 175	← 1587	
							1 987 477 177	→ 1332	
						RLE	1 987 477 190	910	
FT 280 K/S 2.0 TD		08.00-07.06	55/63/74/			FGS,PW	1 987 482 035	← 1648	
FT 280 K/S 2.0 TDCi			92				1 987 482 135	→ 1463	
FT 280 K/S 2.0 TDE						LLE	1 987 477 186	1052	
						PW	1 987 477 174	← 1547	
							1 987 482 036	→ 1283	
						RLE	1 987 477 190	910	
FT 280 K/S 2.3i		04.01-07.06	66/103-107			LLE	1 987 477 186	1052	
FT 280 K/S 2.4 TDE						PW	1 987 477 178	← 1528	
							1 987 482 036	→ 1283	
						OZB,PW	1 987 477 180	← 1608	
							1 987 477 185	→ 1386	
						PW,ZWB	1 987 477 175	← 1587	
							1 987 477 177	→ 1332	
						RLE	1 987 477 190	910	
FT 280 L 2.3i		01.00-07.06	55/66/85/			LLE	1 987 477 186	1052	
FT 280 L 2.4 TDE			92/103-107			MI	1 987 482 195	1919	
						PW	1 987 477 178	← 1528	
							1 987 482 036	→ 1283	
						OZB,PW	1 987 477 180	← 1608	
							1 987 477 185	→ 1386	
						PW,ZWB	1 987 477 175	← 1587	
							1 987 477 177	→ 1332	
						RLE	1 987 477 190	910	



		S							
◀ FORD Transit [F_ _ _]									
FT 280 M 2.0 TD		08.00-07.06	55/63/74/			FGS,MI,PW	1987 482 194	300	
FT 280 M 2.0 TDCi			92			FGS,PW	1987 482 035	← 1648	
FT 280 M 2.0 TDE							1987 482 135	→ 1463	
						LLE	1987 477 186	1052	
						PW	1987 477 174	← 1547	
							1987 482 036	→ 1283	
						RLE	1987 477 190	910	
FT 280 M 2.3i		04.01-07.06	66/103-107			LLE	1987 477 186	1052	
FT 280 M 2.4 TDE						MI	1987 482 194	300	
						PW	1987 477 178	← 1528	
							1987 482 036	→ 1283	
						OZB,PW	1987 477 180	← 1608	
							1987 477 185	→ 1386	
						PW,ZWB	1987 477 175	← 1587	
							1987 477 177	→ 1332	
						RLE	1987 477 190	910	
FT 300 K/S 2.0 TD		08.00-07.06	55/63/74/			FGS,PW	1987 482 035	← 1648	
FT 300 K/S 2.0 TDCi			92				1987 482 135	→ 1463	
FT 300 K/S 2.0 TDE						LLE	1987 477 186	1052	
						PW	1987 477 174	← 1547	
							1987 482 036	→ 1283	
						RLE	1987 477 190	910	
FT 300 K/S 2.3i		08.00-07.06	107			LLE	1987 477 186	1052	
						PW	1987 477 178	← 1528	
							1987 482 036	→ 1283	
						OZB,PW	1987 477 180	← 1608	
							1987 477 185	→ 1386	
						PW,ZWB	1987 477 175	← 1587	
							1987 477 177	→ 1332	
						RLE	1987 477 190	910	
FT 300 L 2.0 TD		08.00-07.06	55/63/74/			FGS,PW	1987 482 035	← 1648	
FT 300 L 2.0 TDCi			92				1987 482 135	→ 1463	
FT 300 L 2.0 TDE						LLE	1987 477 186	1052	
						PW	1987 477 174	← 1547	
							1987 482 036	→ 1283	
						RLE	1987 477 190	910	
FT 300 L 2.3i		08.00-07.06	107			LLE	1987 477 186	1052	
						MI	1987 482 195	1919	
						PW	1987 477 178	← 1528	
							1987 482 036	→ 1283	
						OZB,PW	1987 477 180	← 1608	
							1987 477 185	→ 1386	
						PW,ZWB	1987 477 175	← 1587	
							1987 477 177	→ 1332	
						RLE	1987 477 190	910	
FT 300 M 2.0 TD		08.00-07.06	55/63/74/			FGS,MI,	1987 482 194	300	
FT 300 M 2.0 TDCi			92			PW			
FT 300 M 2.0 TDE						FGS,PW	1987 482 035	← 1648	
							1987 482 135	→ 1463	
						LLE	1987 477 186	1052	
						PW	1987 477 174	← 1547	
							1987 482 036	→ 1283	
						RLE	1987 477 190	910	
FT 300 M 2.3i		08.00-07.06	107			LLE	1987 477 186	1052	
						MI	1987 482 194	300	
						PW	1987 477 178	← 1528	
							1987 482 036	→ 1283	
						OZB,PW	1987 477 180	← 1608	
							1987 477 185	→ 1386	
						PW,ZWB	1987 477 175	← 1587	
							1987 477 177	→ 1332	
						RLE	1987 477 190	910	



		S							
FT 330 K/S 2.0 TDCi	05.02-07.06	74/92				FGS,PW	1 987 482 035	← 1648	
FT 330 K/S 2.0 TDE							1 987 482 135	→ 1463	
						LLE	1 987 477 186	1052	
						PW	1 987 477 174	← 1547	
							1 987 482 036	→ 1283	
						RLE	1 987 477 190	910	
FT 330 K/S 2.3i	01.00-07.06	55/66/85/				LLE	1 987 477 186	1052	
FT 330 K/S 2.4 TD		88/101/				PW	1 987 477 178	← 1528	
FT 330 K/S 2.4 TDCi		103-107					1 987 482 036	→ 1283	
FT 330 K/S 2.4 TDE						OZB,PW	1 987 477 180	← 1608	
							1 987 477 185	→ 1386	
						PW,ZWB	1 987 477 175	← 1587	
							1 987 477 177	→ 1332	
						RLE	1 987 477 190	910	
FT 330 K/S 2.4 TDE	01.00-07.06	92				LLE	1 987 477 186	1052	
						PW	1 987 477 178	← 1528	
							1 987 482 036	→ 1283	
						OZB,PW	1 987 477 180	← 1608	
							1 987 477 185	→ 1386	
						PW,ZWB	1 987 477 175	← 1587	
							1 987 477 177	→ 1332	
						RLE	1 987 477 190	910	
FT 330 L 2.0 TDCi	05.02-07.06	92				FGS,PW	1 987 482 035	← 1648	
							1 987 482 135	→ 1463	
						LLE	1 987 477 186	1052	
						PW	1 987 477 174	← 1547	
							1 987 482 036	→ 1283	
						RLE	1 987 477 190	910	
FT 330 L 2.0 TDE	08.03-07.06	74				FGS,PW	1 987 482 035	← 1648	
							1 987 482 135	→ 1463	
						LLE	1 987 477 186	1052	
						PW	1 987 477 174	← 1547	
							1 987 482 036	→ 1283	
						RLE	1 987 477 190	910	
FT 330 L 2.3i	01.00-07.06	55/66/85/				LLE	1 987 477 186	1052	
FT 330 L 2.4 TD		88/101/				MI	1 987 482 195	1919	
FT 330 L 2.4 TDCi		103-107				PW	1 987 477 178	← 1528	
FT 330 L 2.4 TDE							1 987 482 036	→ 1283	
						OZB,PW	1 987 477 180	← 1608	
							1 987 477 185	→ 1386	
						PW,ZWB	1 987 477 175	← 1587	
							1 987 477 177	→ 1332	
						RLE	1 987 477 190	910	
FT 330 L 2.4 TDE	01.00-07.06	92				LLE	1 987 477 186	1052	
						MI	1 987 482 195	1919	
						PW	1 987 477 178	← 1528	
							1 987 482 036	→ 1283	
						OZB,PW	1 987 477 180	← 1608	
							1 987 477 185	→ 1386	
						PW,ZWB	1 987 477 175	← 1587	
							1 987 477 177	→ 1332	
						RLE	1 987 477 190	910	
FT 330 M 2.0 TDCi	05.02-07.06	92				FGS,MI,PW	1 987 482 194	300	
						FGS,PW	1 987 482 035	← 1648	
							1 987 482 135	→ 1463	
						LLE	1 987 477 186	1052	
						PW	1 987 477 174	← 1547	
							1 987 482 036	→ 1283	
						RLE	1 987 477 190	910	













◀ FORD Transit [F_...]

FT 330 M 2.0 TDE	08.03-07.06	74	FGS,MI,PW	1987 482 194	300
			FGS,PW	1987 482 035	← 1648
				1987 482 135	→ 1463
			LLE	1987 477 186	1052
			PW	1987 477 174	← 1547
				1987 482 036	→ 1283
			RLE	1987 477 190	910
FT 330 M 2.3i	01.00-07.06	55/66/85/	LLE	1987 477 186	1052
FT 330 M 2.4 TD		88/101/	MI	1987 482 194	300
FT 330 M 2.4 TDCi		103-107	PW	1987 477 178	← 1528
FT 330 M 2.4 TDE				1987 482 036	→ 1283
			OZB,PW	1987 477 180	← 1608
				1987 477 185	→ 1386
			PW,ZWB	1987 477 175	← 1587
				1987 477 177	→ 1332
			RLE	1987 477 190	910
FT 330 M 2.4 TDE	01.00-07.06	92	LLE	1987 477 186	1052
			MI	1987 482 194	300
			PW	1987 477 178	← 1528
				1987 482 036	→ 1283
			OZB,PW	1987 477 180	← 1608
				1987 477 185	→ 1386
			PW,ZWB	1987 477 175	← 1587
				1987 477 177	→ 1332
			RLE	1987 477 190	910
FT 350 EL 2.0 TDCi	05.02-07.06	92	FGS,PW	1987 482 035	← 1648
				1987 482 135	→ 1463
			LLE	1987 477 186	1052
			MI	1987 482 195	1919
			PW	1987 477 174	← 1547
				1987 482 036	→ 1283
			RLE	1987 477 190	910
FT 350 EL 2.0 TDE	08.03-07.06	74	FGS,PW	1987 482 035	← 1648
				1987 482 135	→ 1463
			LLE	1987 477 186	1052
			MI	1987 482 195	1919
			PW	1987 477 174	← 1547
				1987 482 036	→ 1283
			RLE	1987 477 190	910
FT 350 EL 2.3i	01.00-07.06	55/66/85/	LLE	1987 477 186	1052
FT 350 EL 2.4 TD		101/	MI	1987 482 195	1919
FT 350 EL 2.4 TDCi		103-107	PW	1987 477 178	← 1528
FT 350 EL 2.4 TDE				1987 482 036	→ 1283
			OZB,PW	1987 477 180	← 1608
				1987 477 185	→ 1386
			PW,ZWB	1987 477 175	← 1587
				1987 477 177	→ 1332
			RLE	1987 477 190	910
FT 350 EL 2.4 TDE	01.00-07.06	92	LLE	1987 477 186	1052
			MI	1987 482 195	1919
			PW	1987 477 178	← 1528
				1987 482 036	→ 1283
			OZB,PW	1987 477 180	← 1608
				1987 477 185	→ 1386
			PW,ZWB	1987 477 175	← 1587
				1987 477 177	→ 1332
			RLE	1987 477 190	910
FT 350 L 2.0 TDCi	05.02-07.06	92	FGS,PW	1987 482 035	← 1648
				1987 482 135	→ 1463
			LLE	1987 477 186	1052
			PW	1987 477 174	← 1547
				1987 482 036	→ 1283
			RLE	1987 477 190	910



		S							
FT 350 L 2.0 TDE	08.03-07.06	74							
						FGS,PW	1 987 482 035	← 1648	
							1 987 482 135	→ 1463	
						LLE	1 987 477 186	1052	
						PW	1 987 477 174	← 1547	
							1 987 482 036	→ 1283	
						RLE	1 987 477 190	910	
FT 350 L 2.3i	01.00-07.06	55/66/85/							
FT 350 L 2.4 TD		88/101/							
FT 350 L 2.4 TDCi		103-107							
FT 350 L 2.4 TDE									
						LLE	1 987 477 186	1052	
						MI	1 987 482 195	1919	
						PW	1 987 477 178	← 1528	
							1 987 482 036	→ 1283	
						OZB,PW	1 987 477 180	← 1608	
							1 987 477 185	→ 1386	
						PW,ZWB	1 987 477 175	← 1587	
							1 987 477 177	→ 1332	
						RLE	1 987 477 190	910	
FT 350 L 2.4 TDE	01.00-07.06	92							
						LLE	1 987 477 186	1052	
						MI	1 987 482 195	1919	
						PW	1 987 477 178	← 1528	
							1 987 482 036	→ 1283	
						OZB,PW	1 987 477 180	← 1608	
							1 987 477 185	→ 1386	
						PW,ZWB	1 987 477 175	← 1587	
							1 987 477 177	→ 1332	
						RLE	1 987 477 190	910	
FT 350 M 2.0 TDCi	05.02-07.06	92							
						FGS,MI,PW	1 987 482 194	300	
						FGS,PW	1 987 482 035	← 1648	
							1 987 482 135	→ 1463	
						LLE	1 987 477 186	1052	
						PW	1 987 477 174	← 1547	
							1 987 482 036	→ 1283	
						RLE	1 987 477 190	910	
FT 350 M 2.0 TDE	08.03-07.06	74							
						FGS,MI,PW	1 987 482 194	300	
						FGS,PW	1 987 482 035	← 1648	
							1 987 482 135	→ 1463	
						LLE	1 987 477 186	1052	
						PW	1 987 477 174	← 1547	
							1 987 482 036	→ 1283	
						RLE	1 987 477 190	910	
FT 350 M 2.3i	01.00-07.06	55/66/85/							
FT 350 M 2.4 TD		88/92/101/							
FT 350 M 2.4 TDCi		103-107							
FT 350 M 2.4 TDE									
						LLE	1 987 477 186	1052	
						MI	1 987 482 194	300	
						PW	1 987 477 178	← 1528	
							1 987 482 036	→ 1283	
						OZB,PW	1 987 477 180	← 1608	
							1 987 477 185	→ 1386	
						PW,ZWB	1 987 477 175	← 1587	
							1 987 477 177	→ 1332	
						RLE	1 987 477 190	910	
FT 430 EL 2.4 TD	08.02-07.06	55/66/85/							
FT 430 EL 2.4 TDCi		92/101							
FT 430 EL 2.4 TDE									
						LLE	1 987 477 186	1052	
						MI	1 987 482 195	1919	
						PW	1 987 477 178	← 1528	
							1 987 482 036	→ 1283	
						OZB,PW	1 987 477 180	← 1608	
							1 987 477 185	→ 1386	
						PW,ZWB	1 987 477 175	← 1587	
							1 987 477 177	→ 1332	
						RLE	1 987 477 190	910	













◀ FORD Transit [F_ _ _]				
FT 430 M 2.4 TD	08.02-07.06 55/85/92/	LLE	1987 477 186	1052
FT 430 M 2.4 TDCi	101	MI	1987 482 194	300
FT 430 M 2.4 TDE		PW	1987 477 178	← 1528
			1987 482 036	→ 1283
		OZB,PW	1987 477 180	← 1608
			1987 477 185	→ 1386
		PW,ZWB	1987 477 175	← 1587
			1987 477 177	→ 1332
		RLE	1987 477 190	910

	FT 240 K/S 2.0 TD, 2.0 TDE	08.00-07.06 55/63/74/92		0 265 220 539 ¹⁴
	FT 260 K/S 2.0 TD, 2.0 TDCi			
	FT 260 K/S 2.0 TDE			
	FT 260 K/S 2.3i, 2.4 TDE	04.01-07.06 66/103-107		0 265 220 487 ¹⁴
	FT 280 K/S 2.0 TD, 2.0 TDCi	08.00-07.06 55/63/74/92		0 265 220 539 ¹⁴
	FT 280 K/S 2.0 TDE			
	FT 280 K/S 2.3i, 2.4 TDE	01.00-07.06 55/66/85/		0 265 220 487 ¹⁴
	FT 280 L 2.3i, 2.4 TDE	92/103-107		
	FT 280 M 2.0 TD, 2.0 TDCi	08.00-07.06 55/63/74/92		0 265 220 539 ¹⁴
	FT 280 M 2.0 TDE			
	FT 280 M 2.3i, 2.4 TDE	04.01-07.06 66/103-107		0 265 220 487 ¹⁴
	FT 300 K/S 2.0 TD, 2.0 TDCi	08.00-07.06 55/63/74/92		0 265 220 539 ¹⁴
	FT 300 K/S 2.0 TDE			
	FT 300 K/S 2.3i	08.00-07.06 107		0 265 220 487 ¹⁴
	FT 300 L 2.0 TD, 2.0 TDCi	08.00-07.06 55/63/74/92		0 265 220 539 ¹⁴
	FT 300 L 2.0 TDE			
	FT 300 L 2.3i	08.00-07.06 107		0 265 220 487 ¹⁴
	FT 300 M 2.0 TD, 2.0 TDCi	08.00-07.06 55/63/74/92		0 265 220 539 ¹⁴
	FT 300 M 2.0 TDE			
	FT 300 M 2.3i	08.00-07.06 107		0 265 220 487 ¹⁴
	FT 330 K/S 2.0 TDCi	05.02-07.06 74/92		0 265 216 999 ¹¹
	FT 330 K/S 2.0 TDE	07.03-07.06 74/92		0 265 220 693 ¹⁴
	FT 330 K/S 2.3i, 2.4 TD	01.00-07.06 55/66/85/88/101/		0 265 220 487 ¹⁴
	FT 330 K/S 2.4 TDCi, 2.4 TDE	103-107		
	FT 330 K/S 2.4 TDE	01.00-07.06 92		0 265 220 487 ¹⁴
	FT 330 L 2.0 TDCi	05.02-07.06 92		0 265 216 999 ¹¹
		07.03-07.06 92		0 265 220 693 ¹⁴
	FT 330 L 2.0 TDE	08.03-07.06 74		0 265 216 999 ¹¹
				0 265 220 693 ¹⁴
	FT 330 L 2.3i, 2.4 TD	01.00-07.06 55/66/85/88/101/		0 265 220 487 ¹⁴
	FT 330 L 2.4 TDCi, 2.4 TDE	103-107		
	FT 330 L 2.4 TDE	01.00-07.06 92		0 265 220 487 ¹⁴
	FT 330 M 2.0 TDCi	05.02-07.06 92		0 265 216 999 ¹¹
		07.03-07.06 92		0 265 220 693 ¹⁴
	FT 330 M 2.0 TDE	08.03-07.06 74		0 265 216 999 ¹¹
				0 265 220 693 ¹⁴
	FT 330 M 2.3i, 2.4 TD	01.00-07.06 55/66/85/88/101/		0 265 220 487 ¹⁴
	FT 330 M 2.4 TDCi, 2.4 TDE	103-107		
	FT 330 M 2.4 TDE	01.00-07.06 92		0 265 220 487 ¹⁴
	FT 350 EL 2.0 TDCi	05.02-07.06 92		0 265 216 999 ¹¹
		07.03-07.06 92		0 265 220 693 ¹⁴
	FT 350 EL 2.0 TDE	08.03-07.06 74		0 265 216 999 ¹¹
				0 265 220 693 ¹⁴
	FT 350 EL 2.3i, 2.4 TD	01.00-07.06 55/66/85/101/		0 265 220 487 ¹⁴
	FT 350 EL 2.4 TDCi, 2.4 TDE	103-107		
	FT 350 EL 2.4 TDE	01.00-07.06 92		0 265 220 487 ¹⁴
	FT 350 L 2.0 TDCi	05.02-07.06 92		0 265 216 999 ¹¹
		07.03-07.06 92		0 265 220 693 ¹⁴
	FT 350 L 2.0 TDE	08.03-07.06 74		0 265 216 999 ¹¹
				0 265 220 693 ¹⁴
	FT 350 L 2.3i, 2.4 TD	01.00-07.06 55/66/85/88/101/		0 265 220 487 ¹⁴
	FT 350 L 2.4 TDCi, 2.4 TDE	103-107		
	FT 350 L 2.4 TDE	01.00-07.06 92		0 265 220 487 ¹⁴



		S							
FT 350 M 2.0 TDCi		05.02-07.06	92				0 265 216 999 ¹¹		
		07.03-07.06	92				0 265 220 693 ¹⁴		
FT 350 M 2.0 TDE		08.03-07.06	74				0 265 216 999 ¹¹		
							0 265 220 693 ¹⁴		
FT 350 M 2.3i, 2.4 TD		01.00-07.06	55/66/85/88/92/101/				0 265 220 487 ¹⁴		
FT 350 M 2.4 TDCi, 2.4 TDE			103-107						
FT 430 EL 2.4 TD, 2.4 TDCi		08.02-07.06	55/66/85/88/92/101/				0 265 220 487 ¹⁴		
FT 430 EL 2.4 TDE			103-107						
FT 430 M 2.4 TD, 2.4 TDCi									
FT 430 M 2.4 TDE									
 FT 240 K/S 2.0 TD		08.00-05.04	55/63/74/92		LAB,TW		0 265 006 818 ⁴		
FT 240 K/S 2.0 TDE		08.00-07.06	55/63/74/92		RAB,TW		0 265 006 815 ⁴		
FT 260 K/S 2.0 TD							0 265 006 817 ⁴		
FT 260 K/S 2.0 TDCi					TW		0 265 006 458 ³		
FT 260 K/S 2.0 TDE		07.03-07.06	55/63/74/92		LAB,TW		0 265 006 784 ⁴		
					TW		0 265 006 784 ³		
		11.03-05.04	55/63/74/92		RAB,TW		0 265 006 460 ⁴		
		05.04-07.06	55/63/74/92		LAB,TW		0 265 006 816 ⁴		
					RAB,TW		0 265 006 811 ⁴		
FT 260 K/S 2.3i		04.01-07.06	66/103-107				0 265 006 458 ³		
FT 260 K/S 2.4 TDE					LAB,TW		0 265 006 461 ⁴		
							0 265 006 814 ⁴		
					RAB,TW		0 265 006 460 ⁴		
							0 265 006 813 ⁴		
		12.02-07.06	66/103-107		LAB,TW		0 265 006 812 ⁴		
		03.04-07.06	66/103-107		RAB,TW		0 265 006 811 ⁴		
FT 280 K/S 2.0 TD		08.00-05.04	55/63/74/92		LAB,TW		0 265 006 818 ⁴		
FT 280 K/S 2.0 TDCi		08.00-07.06	55/63/74/92		RAB,TW		0 265 006 815 ⁴		
FT 280 K/S 2.0 TDE							0 265 006 817 ⁴		
					TW		0 265 006 458 ³		
		07.03-07.06	55/63/74/92		LAB,TW		0 265 006 784 ⁴		
					TW		0 265 006 784 ³		
		11.03-05.04	55/63/74/92		RAB,TW		0 265 006 460 ⁴		
		05.04-07.06	55/63/74/92		LAB,TW		0 265 006 816 ⁴		
					RAB,TW		0 265 006 811 ⁴		
FT 280 K/S 2.3i		04.01-07.06	66/103-107				0 265 006 458 ³		
FT 280 K/S 2.4 TDE					LAB,TW		0 265 006 461 ⁴		
							0 265 006 814 ⁴		
					RAB,TW		0 265 006 460 ⁴		
							0 265 006 813 ⁴		
		12.02-07.06	66/103-107		LAB,TW		0 265 006 812 ⁴		
		03.04-07.06	66/103-107		RAB,TW		0 265 006 811 ⁴		
FT 280 L 2.3i		08.01-07.06	66/103-107				0 265 006 458 ³		
					LAB,TW		0 265 006 461 ⁴		
							0 265 006 814 ⁴		
					RAB,TW		0 265 006 460 ⁴		
							0 265 006 813 ⁴		
		12.02-07.06	66/103-107		LAB,TW		0 265 006 812 ⁴		
		03.04-07.06	66/103-107		RAB,TW		0 265 006 811 ⁴		
FT 280 L 2.4 TDE		01.00-09.03	55				0 265 006 458 ³		
					LAB,TW		0 265 006 461 ⁴		
							0 265 006 814 ⁴		
					RAB,TW		0 265 006 460 ⁴		
							0 265 006 813 ⁴		
		01.00-07.06	66/85/92				0 265 006 458 ³		
					LAB,TW		0 265 006 461 ⁴		
							0 265 006 814 ⁴		
					RAB,TW		0 265 006 460 ⁴		
							0 265 006 813 ⁴		
		12.02-09.03	55		LAB,TW		0 265 006 812 ⁴		
		12.02-07.06	66/85/92		LAB,TW		0 265 006 812 ⁴		
		03.04-07.06	66/85/92		RAB,TW		0 265 006 811 ⁴		













F ◀ FORD Transit [F_ _ _]

FT 280 M 2.0 TD	08.00-05.04	55/63/74/92	LAB,TW	0 265 006 818 ⁴
FT 280 M 2.0 TDCi	08.00-07.06	55/63/74/92	RAB,TW	0 265 006 815 ⁴
FT 280 M 2.0 TDE				0 265 006 817 ⁴
			TW	0 265 006 458 ³
	07.03-07.06	55/63/74/92	LAB,TW	0 265 006 784 ⁴
			TW	0 265 006 784 ³
	11.03-05.04	55/63/74/92	RAB,TW	0 265 006 460 ⁴
	05.04-07.06	55/63/74/92	LAB,TW	0 265 006 816 ⁴
			RAB,TW	0 265 006 811 ⁴
FT 280 M 2.3i	04.01-07.06	66/103-107		0 265 006 458 ³
FT 280 M 2.4 TDE			LAB,TW	0 265 006 461 ⁴
				0 265 006 814 ⁴
			RAB,TW	0 265 006 460 ⁴
				0 265 006 813 ⁴
	12.02-07.06	66/103-107	LAB,TW	0 265 006 812 ⁴
	03.04-07.06	66/103-107	RAB,TW	0 265 006 811 ⁴
FT 300 K/S 2.0 TD	08.00-05.04	55/63/74/92	LAB,TW	0 265 006 818 ⁴
FT 300 K/S 2.0 TDCi	08.00-07.06	55/63/74/92	RAB,TW	0 265 006 815 ⁴
FT 300 K/S 2.0 TDE				0 265 006 817 ⁴
			TW	0 265 006 458 ³
	07.03-07.06	55/63/74/92	LAB,TW	0 265 006 784 ⁴
			TW	0 265 006 784 ³
	11.03-05.04	55/63/74/92	RAB,TW	0 265 006 460 ⁴
	05.04-07.06	55/63/74/92	LAB,TW	0 265 006 816 ⁴
			RAB,TW	0 265 006 811 ⁴
FT 300 K/S 2.3i	08.00-07.06	107		0 265 006 458 ³
			LAB,TW	0 265 006 461 ⁴
				0 265 006 814 ⁴
			RAB,TW	0 265 006 460 ⁴
				0 265 006 813 ⁴
	12.02-07.06	107	LAB,TW	0 265 006 812 ⁴
	03.04-07.06	107	RAB,TW	0 265 006 811 ⁴
FT 300 L 2.0 TD	08.00-05.04	55/63/74/92	LAB,TW	0 265 006 818 ⁴
FT 300 L 2.0 TDCi	08.00-07.06	55/63/74/92	RAB,TW	0 265 006 815 ⁴
FT 300 L 2.0 TDE				0 265 006 817 ⁴
			TW	0 265 006 458 ³
	07.03-07.06	55/63/74/92	LAB,TW	0 265 006 784 ⁴
			TW	0 265 006 784 ³
	11.03-05.04	55/63/74/92	RAB,TW	0 265 006 460 ⁴
	05.04-07.06	55/63/74/92	LAB,TW	0 265 006 816 ⁴
			RAB,TW	0 265 006 811 ⁴
FT 300 L 2.3i	08.00-07.06	107		0 265 006 458 ³
			LAB,TW	0 265 006 461 ⁴
				0 265 006 814 ⁴
			RAB,TW	0 265 006 460 ⁴
				0 265 006 813 ⁴
	12.02-07.06	107	LAB,TW	0 265 006 812 ⁴
	03.04-07.06	107	RAB,TW	0 265 006 811 ⁴
FT 300 M 2.0 TD	08.00-05.04	55/63/74/92	LAB,TW	0 265 006 818 ⁴
FT 300 M 2.0 TDCi	08.00-07.06	55/63/74/92	RAB,TW	0 265 006 815 ⁴
FT 300 M 2.0 TDE				0 265 006 817 ⁴
			TW	0 265 006 458 ³
	07.03-07.06	55/63/74/92	LAB,TW	0 265 006 784 ⁴
			TW	0 265 006 784 ³
	11.03-05.04	55/63/74/92	RAB,TW	0 265 006 460 ⁴
	05.04-07.06	55/63/74/92	LAB,TW	0 265 006 816 ⁴
			RAB,TW	0 265 006 811 ⁴











		S								
FT 300 M 2.3i	08.00-07.06	107					0 265 006 458 ³			
							LAB,TW	0 265 006 461 ⁴		
								0 265 006 814 ⁴		
							RAB,TW	0 265 006 460 ⁴		
								0 265 006 813 ⁴		
								0 265 006 812 ⁴		
FT 330 K/S 2.0 TDCi	05.02-05.04	74/92					0 265 006 818 ⁴			
							LAB,TW	0 265 006 818 ⁴		
FT 330 K/S 2.0 TDE	05.02-07.06	74/92					0 265 006 815 ⁴			
							RAB,TW	0 265 006 815 ⁴		
							0 265 006 817 ⁴			
							0 265 006 458 ³			
	07.03-07.06	74/92					LAB,TW	0 265 006 784 ⁴		
							TW	0 265 006 784 ³		
	11.03-05.04	74/92					RAB,TW	0 265 006 460 ⁴		
	05.04-07.06	74/92					LAB,TW	0 265 006 816 ⁴		
							RAB,TW	0 265 006 811 ⁴		
FT 330 K/S 2.3i	12.00-07.06	103-107					0 265 006 458 ³			
							LAB,TW	0 265 006 461 ⁴		
								0 265 006 814 ⁴		
							RAB,TW	0 265 006 460 ⁴		
								0 265 006 813 ⁴		
								0 265 006 812 ⁴		
FT 330 K/S 2.4 TD	01.00-09.03	55					0 265 006 458 ³			
							LAB,TW	0 265 006 461 ⁴		
							0 265 006 814 ⁴			
							RAB,TW	0 265 006 460 ⁴		
							0 265 006 813 ⁴			
	12.02-09.03	55					LAB,TW	0 265 006 812 ⁴		
FT 330 K/S 2.4 TDCi	01.00-07.06	66/85/88/101					0 265 006 458 ³			
							LAB,TW	0 265 006 461 ⁴		
FT 330 K/S 2.4 TDE	01.00-07.06	66/85/88/101					0 265 006 814 ⁴			
							RAB,TW	0 265 006 460 ⁴		
							0 265 006 813 ⁴			
	12.02-07.06	66/85/88/101					LAB,TW	0 265 006 812 ⁴		
	03.04-07.06	66/85/88/101					RAB,TW	0 265 006 811 ⁴		
FT 330 K/S 2.4 TDE	01.00-07.06	92					0 265 006 458 ³			
							LAB,TW	0 265 006 461 ⁴		
								0 265 006 814 ⁴		
							RAB,TW	0 265 006 460 ⁴		
								0 265 006 813 ⁴		
								0 265 006 812 ⁴		
FT 330 L 2.0 TDCi	05.02-05.04	92					0 265 006 818 ⁴			
							LAB,TW	0 265 006 818 ⁴		
								0 265 006 815 ⁴		
							RAB,TW	0 265 006 815 ⁴		
								0 265 006 817 ⁴		
								0 265 006 458 ³		
	07.03-07.06	92					LAB,TW	0 265 006 784 ⁴		
							TW	0 265 006 784 ³		
	11.03-05.04	92					RAB,TW	0 265 006 460 ⁴		
	05.04-07.06	92					LAB,TW	0 265 006 816 ⁴		
							RAB,TW	0 265 006 811 ⁴		
FT 330 L 2.0 TDE	08.03-05.04	74					0 265 006 818 ⁴			
							LAB,TW	0 265 006 818 ⁴		
								0 265 006 815 ⁴		
							RAB,TW	0 265 006 815 ⁴		
								0 265 006 817 ⁴		
								0 265 006 458 ³		
	08.03-07.06	74					LAB,TW	0 265 006 784 ⁴		
							RAB,TW	0 265 006 815 ⁴		
							0 265 006 817 ⁴			
							TW	0 265 006 458 ³		
							0 265 006 784 ³			
	11.03-05.04	74					RAB,TW	0 265 006 460 ⁴		
	05.04-07.06	74					LAB,TW	0 265 006 816 ⁴		
							RAB,TW	0 265 006 811 ⁴		



		S								
◀ FORD Transit [F_ _ _]										
FT 330L 2.3i	12.00-07.06	103-107							0 265 006 458 ³	
							LAB,TW		0 265 006 461 ⁴	
	12.02-07.06	103-107								0 265 006 814 ⁴
								RAB,TW		0 265 006 460 ⁴
										0 265 006 813 ⁴
										0 265 006 812 ⁴
	03.04-07.06	103-107							0 265 006 811 ⁴	
FT 330L 2.4 TD	12.02-09.03	55							0 265 006 458 ³	
							LAB,TW		0 265 006 461 ⁴	
	12.02-09.03	55								0 265 006 814 ⁴
								RAB,TW		0 265 006 460 ⁴
										0 265 006 813 ⁴
										0 265 006 812 ⁴
	01.00-09.03	66/85/88/101							0 265 006 458 ³	
FT 330L 2.4 TDCi	12.02-07.06	66/85/88/101							0 265 006 461 ⁴	
							LAB,TW		0 265 006 814 ⁴	
	12.02-07.06	66/85/88/101								0 265 006 460 ⁴
								RAB,TW		0 265 006 813 ⁴
										0 265 006 812 ⁴
										0 265 006 811 ⁴
	03.04-07.06	66/85/88/101							0 265 006 458 ³	
FT 330L 2.4 TDE	12.02-07.06	92							0 265 006 461 ⁴	
							LAB,TW		0 265 006 814 ⁴	
	12.02-07.06	92								0 265 006 460 ⁴
								RAB,TW		0 265 006 813 ⁴
										0 265 006 812 ⁴
										0 265 006 811 ⁴
	03.04-07.06	92							0 265 006 458 ³	
FT 330M 2.0 TDCi	12.02-07.06	92							0 265 006 461 ⁴	
							LAB,TW		0 265 006 814 ⁴	
	12.02-07.06	92								0 265 006 460 ⁴
								RAB,TW		0 265 006 815 ⁴
										0 265 006 817 ⁴
										0 265 006 458 ³
	07.03-07.06	92							0 265 006 784 ⁴	
FT 330M 2.0 TDE	11.03-05.04	92							0 265 006 784 ³	
							RAB,TW		0 265 006 460 ⁴	
	11.03-05.04	92								0 265 006 816 ⁴
								RAB,TW		0 265 006 811 ⁴
										0 265 006 818 ⁴
										0 265 006 814 ⁴
	08.03-05.04	74							0 265 006 458 ³	
FT 330M 2.0 TDE	11.03-05.04	74							0 265 006 784 ³	
							RAB,TW		0 265 006 460 ⁴	
	11.03-05.04	74								0 265 006 816 ⁴
								RAB,TW		0 265 006 811 ⁴
										0 265 006 815 ⁴
										0 265 006 817 ⁴
	08.03-07.06	74							0 265 006 458 ³	
FT 330M 2.3i	12.00-07.06	103-107							0 265 006 458 ³	
							LAB,TW		0 265 006 461 ⁴	
	12.02-07.06	103-107								0 265 006 814 ⁴
								RAB,TW		0 265 006 460 ⁴
										0 265 006 813 ⁴
										0 265 006 812 ⁴
	03.04-07.06	103-107							0 265 006 811 ⁴	
FT 330M 2.4 TD	12.00-07.06	103-107							0 265 006 458 ³	
							LAB,TW		0 265 006 461 ⁴	
	12.02-09.03	55								0 265 006 814 ⁴
								RAB,TW		0 265 006 460 ⁴
										0 265 006 813 ⁴
										0 265 006 812 ⁴











		S							
FT 330 M 2.4 TDCi									
FT 330 M 2.4 TDE									
		01.00-07.06	66/85/88/101				0 265 006 458 ³		
					LAB,TW		0 265 006 461 ⁴		
							0 265 006 814 ⁴		
					RAB,TW		0 265 006 460 ⁴		
							0 265 006 813 ⁴		
		12.02-07.06	66/85/88/101		LAB,TW		0 265 006 812 ⁴		
		03.04-07.06	66/85/88/101		RAB,TW		0 265 006 811 ⁴		
FT 330 M 2.4 TDE		01.00-07.06	92				0 265 006 458 ³		
					LAB,TW		0 265 006 461 ⁴		
							0 265 006 814 ⁴		
					RAB,TW		0 265 006 460 ⁴		
							0 265 006 813 ⁴		
		12.02-07.06	92		LAB,TW		0 265 006 812 ⁴		
		03.04-07.06	92		RAB,TW		0 265 006 811 ⁴		
FT 350 EL 2.0 TDCi		05.02-05.04	92		LAB,TW		0 265 006 818 ⁴		
		05.02-07.06	92		RAB,TW		0 265 006 815 ⁴		
							0 265 006 817 ⁴		
					TW		0 265 006 458 ³		
		07.03-07.06	92		LAB,TW		0 265 006 784 ⁴		
					TW		0 265 006 784 ³		
		11.03-05.04	92		RAB,TW		0 265 006 460 ⁴		
		05.04-07.06	92		LAB,TW		0 265 006 816 ⁴		
					RAB,TW		0 265 006 811 ⁴		
FT 350 EL 2.0 TDE		08.03-05.04	74		LAB,TW		0 265 006 818 ⁴		
		08.03-07.06	74		LAB,TW		0 265 006 784 ⁴		
					RAB,TW		0 265 006 815 ⁴		
							0 265 006 817 ⁴		
					TW		0 265 006 458 ³		
							0 265 006 784 ³		
		11.03-05.04	74		RAB,TW		0 265 006 460 ⁴		
		05.04-07.06	74		LAB,TW		0 265 006 816 ⁴		
					RAB,TW		0 265 006 811 ⁴		
FT 350 EL 2.3i		12.00-07.06	103-107				0 265 006 458 ³		
					LAB,TW		0 265 006 461 ⁴		
							0 265 006 814 ⁴		
					RAB,TW		0 265 006 460 ⁴		
							0 265 006 813 ⁴		
		12.02-07.06	103-107		LAB,TW		0 265 006 812 ⁴		
		03.04-07.06	103-107		RAB,TW		0 265 006 811 ⁴		
FT 350 EL 2.4 TD		01.00-09.03	55				0 265 006 458 ³		
					LAB,TW		0 265 006 461 ⁴		
							0 265 006 814 ⁴		
					RAB,TW		0 265 006 460 ⁴		
							0 265 006 813 ⁴		
		12.02-09.03	55		LAB,TW		0 265 006 812 ⁴		
FT 350 EL 2.4 TDCi		01.00-07.06	66/85/101				0 265 006 458 ³		
FT 350 EL 2.4 TDE					LAB,TW		0 265 006 461 ⁴		
							0 265 006 814 ⁴		
					RAB,TW		0 265 006 460 ⁴		
							0 265 006 813 ⁴		
		12.02-07.06	66/85/101		LAB,TW		0 265 006 812 ⁴		
		03.04-07.06	66/85/101		RAB,TW		0 265 006 811 ⁴		
FT 350 EL 2.4 TDE		01.00-07.06	92				0 265 006 458 ³		
					LAB,TW		0 265 006 461 ⁴		
							0 265 006 814 ⁴		
					RAB,TW		0 265 006 460 ⁴		
							0 265 006 813 ⁴		
		12.02-07.06	92		LAB,TW		0 265 006 812 ⁴		
		03.04-07.06	92		RAB,TW		0 265 006 811 ⁴		







		S							
◀ FORD Transit [F_...]									
FT 350L 2.0 TDCi	05.02-05.04	92				LAB,TW	0 265 006 818 ⁴		
	05.02-07.06	92				RAB,TW	0 265 006 815 ⁴		
							0 265 006 817 ⁴		
						TW	0 265 006 458 ³		
	07.03-07.06	92				LAB,TW	0 265 006 784 ⁴		
						TW	0 265 006 784 ³		
	11.03-05.04	92				RAB,TW	0 265 006 460 ⁴		
	05.04-07.06	92				LAB,TW	0 265 006 816 ⁴		
						RAB,TW	0 265 006 811 ⁴		
FT 350L 2.0 TDE	08.03-05.04	74				LAB,TW	0 265 006 818 ⁴		
	08.03-07.06	74				LAB,TW	0 265 006 784 ⁴		
						RAB,TW	0 265 006 815 ⁴		
							0 265 006 817 ⁴		
						TW	0 265 006 458 ³		
							0 265 006 784 ³		
	11.03-05.04	74				RAB,TW	0 265 006 460 ⁴		
	05.04-07.06	74				LAB,TW	0 265 006 816 ⁴		
						RAB,TW	0 265 006 811 ⁴		
FT 350L 2.3i	12.00-07.06	103-107					0 265 006 458 ³		
						LAB,TW	0 265 006 461 ⁴		
							0 265 006 814 ⁴		
						RAB,TW	0 265 006 460 ⁴		
							0 265 006 813 ⁴		
	12.02-07.06	103-107				LAB,TW	0 265 006 812 ⁴		
	03.04-07.06	103-107				RAB,TW	0 265 006 811 ⁴		
FT 350L 2.4 TD	01.00-09.03	55					0 265 006 458 ³		
						LAB,TW	0 265 006 461 ⁴		
							0 265 006 814 ⁴		
						RAB,TW	0 265 006 460 ⁴		
							0 265 006 813 ⁴		
	12.02-09.03	55				LAB,TW	0 265 006 812 ⁴		
FT 350L 2.4 TDCi	01.00-07.06	66/85/88/101					0 265 006 458 ³		
FT 350L 2.4 TDE						LAB,TW	0 265 006 461 ⁴		
							0 265 006 814 ⁴		
						RAB,TW	0 265 006 460 ⁴		
							0 265 006 813 ⁴		
	12.02-07.06	66/85/88/101				LAB,TW	0 265 006 812 ⁴		
	03.04-07.06	66/85/88/101				RAB,TW	0 265 006 811 ⁴		
FT 350L 2.4 TDE	01.00-07.06	92					0 265 006 458 ³		
						LAB,TW	0 265 006 461 ⁴		
							0 265 006 814 ⁴		
						RAB,TW	0 265 006 460 ⁴		
							0 265 006 813 ⁴		
	12.02-07.06	92				LAB,TW	0 265 006 812 ⁴		
	03.04-07.06	92				RAB,TW	0 265 006 811 ⁴		
FT 350M 2.0 TDCi	05.02-05.04	92				LAB,TW	0 265 006 818 ⁴		
	05.02-07.06	92				RAB,TW	0 265 006 815 ⁴		
							0 265 006 817 ⁴		
						TW	0 265 006 458 ³		
	07.03-07.06	92				LAB,TW	0 265 006 784 ⁴		
						TW	0 265 006 784 ³		
	11.03-05.04	92				RAB,TW	0 265 006 460 ⁴		
	05.04-07.06	92				LAB,TW	0 265 006 816 ⁴		
						RAB,TW	0 265 006 811 ⁴		
FT 350M 2.0 TDE	08.03-05.04	74				LAB,TW	0 265 006 818 ⁴		
	08.03-07.06	74				LAB,TW	0 265 006 784 ⁴		
						RAB,TW	0 265 006 815 ⁴		
							0 265 006 817 ⁴		
						TW	0 265 006 458 ³		
							0 265 006 784 ³		
	11.03-05.04	74				RAB,TW	0 265 006 460 ⁴		
	05.04-07.06	74				LAB,TW	0 265 006 816 ⁴		
						RAB,TW	0 265 006 811 ⁴		



	S								
FT 350 M 2.3i	12.00-07.06	103-107				0 265 006 458 ³			
						LAB, TW	0 265 006 461 ⁴		
							0 265 006 814 ⁴		
							RAB, TW	0 265 006 460 ⁴	
							0 265 006 813 ⁴		
		12.02-07.06	103-107				0 265 006 812 ⁴		
	03.04-07.06	103-107				0 265 006 811 ⁴			
FT 350 M 2.4 TD	01.00-09.03	55				0 265 006 458 ³			
						LAB, TW	0 265 006 461 ⁴		
							0 265 006 814 ⁴		
							RAB, TW	0 265 006 460 ⁴	
							0 265 006 813 ⁴		
		12.02-09.03	55				0 265 006 812 ⁴		
FT 350 M 2.4 TDCi	01.00-07.06	66/85/88/92/101				0 265 006 458 ³			
FT 350 M 2.4 TDE						0 265 006 461 ⁴			
						LAB, TW	0 265 006 814 ⁴		
							0 265 006 460 ⁴		
							RAB, TW	0 265 006 813 ⁴	
							0 265 006 812 ⁴		
		12.02-07.06	66/85/88/92/101				0 265 006 812 ⁴		
	03.04-07.06	66/85/88/92/101				0 265 006 811 ⁴			
FT 430 EL 2.4 TD	08.02-09.03	55				0 265 006 458 ³			
						LAB, TW	0 265 006 461 ⁴		
							0 265 006 814 ⁴		
							RAB, TW	0 265 006 460 ⁴	
							0 265 006 813 ⁴		
		12.02-09.03	55				0 265 006 812 ⁴		
FT 430 EL 2.4 TDCi	08.02-07.06	66/85/92/101				0 265 006 458 ³			
FT 430 EL 2.4 TDE						0 265 006 461 ⁴			
						LAB, TW	0 265 006 814 ⁴		
							0 265 006 460 ⁴		
							RAB, TW	0 265 006 813 ⁴	
							0 265 006 812 ⁴		
		12.02-07.06	66/85/92/101				0 265 006 812 ⁴		
	03.04-07.06	66/85/92/101				0 265 006 811 ⁴			
FT 430 M 2.4 TD	08.02-09.03	55				0 265 006 458 ³			
						LAB, TW	0 265 006 461 ⁴		
							0 265 006 814 ⁴		
							RAB, TW	0 265 006 460 ⁴	
							0 265 006 813 ⁴		
		12.02-09.03	55				0 265 006 812 ⁴		
FT 430 M 2.4 TDCi	08.02-07.06	85/92/101				0 265 006 458 ³			
FT 430 M 2.4 TDE						0 265 006 461 ⁴			
						LAB, TW	0 265 006 814 ⁴		
							0 265 006 460 ⁴		
							RAB, TW	0 265 006 813 ⁴	
							0 265 006 812 ⁴		
		12.02-07.06	85/92/101				0 265 006 812 ⁴		
	03.04-07.06	85/92/101				0 265 006 811 ⁴			



Transit Nugget

								
	2.2 TDCi	04.06→	81/85/96/103			0 204 004 617	← 48	
						0 204 004 618	→	
								
	2.2 TDCi	04.06→	81/85/96/103			F 026 002 578	↔ 25,4	



◀ FORD Transit Nugget

	2.2 TDCi	04.06→	81/85/96/103		0 204 902 026	← 48	
					0 204 902 027	→ 48	
	2.2 TDCi	ABO 04.06→	81/85/96/103		0 204 123 717	25,4	
		ABS 04.06→	81/85/96/103		0 204 123 716	25,4	
	2.2 TDCi	04.06→	81/85/96/103		0 204 125 857		0 204 127 528
	2.2 TDCi	04.06→	81/85/96/103	KZB,KZE	0 204 131 703 ¹⁰		
	2.2 TDCi	04.06→	81		0 265 231 704 ¹¹		
					0 265 233 341 ¹⁴		
			96/103	MBH	0 265 234 354 ²⁶		
					0 265 231 704 ¹¹		
			10.08→	85		0 265 233 341 ¹⁴	
					MBH	0 265 234 354 ²⁶	
			0 265 231 704 ¹¹				
			0 265 233 341 ¹⁴				
	2.2 TDCi	04.06→	81/85/96/103	TW	0 265 005 690		



Transit Nugget [E_ _]

	2.0 i	08.94-09.99	51/56/63/		1 987 476 510	→ 430		
			84/85		1 987 476 511	← 430		
			ABS, 10.99-07.00	51/56/63/		1 987 476 510	→ 430	
			OAS	84/85		1 987 476 511	← 430	
	2.5 D	08.94-09.99	51/56/63/		1 987 476 510	→ 430		
	2.5 DI		84/85		1 987 476 511	← 430		
	2.5 TD	ABS, 10.99-08.00	51/56/63/		1 987 476 510	→ 430		
	2.5 TDI	OAS	84/85		1 987 476 511	← 430		
	2.0 i	08.94-08.00	51/56/63/	5LO	0 204 102 925	→ 42	0 204 104 135 ⁷	
			84/85		0 204 103 925			
					0 204 102 926	← 42	0 204 104 135 ⁷	
					0 204 103 926			
	2.5 TD			6LO	0 204 102 934	→ 42	0 204 104 135 ⁷	
	2.5 TDI				0 204 102 935	← 42	0 204 104 135 ⁷	
	2.0 i	08.94-07.00	51/56/63/84/85	BRV	1 987 476 614	447		
			ABS, 08.94-07.00	51/56/63/	BRD	1 987 476 615	415	
			OAS	84/85				
	2.5 D, DI, TD, TDI	08.94-08.00	51/56/63/84/85	BRV	1 987 476 614	447		
		ABS, 08.94-08.00	51/56/63/	BRD	1 987 476 615	415		
		OAS	84/85					



	2.0i	08.94-08.00	51/56/63/		F 026 002 171	↔ 20,6
	2.5 D, DI, TD, TDI		84/85		F 026 002 172	↔ 22,19



	2.0i	ABO 08.94-03.97	51/56/63/84		F 026 003 136	23,8
		04.97-07.00	51/56/63/84		F 026 003 354	23,8
	ABS	04.97-07.00	51/56/63/84		0 204 123 355	23,8
	2.5 D	ABO 08.94-03.97	51/56/63/84		F 026 003 136	23,8
	2.5 DI	04.97-08.00	51/56/63/84		F 026 003 354	23,8
	2.5 TD	ABS 04.97-08.00	51/56/63/84		0 204 123 355	23,8
	2.5 TDI	ABO 03.99-08.00	85		F 026 003 354	23,8
		ABS 03.99-08.00	85		0 204 123 355	23,8

	2.0i	04.97-07.00	51/56/63/84	LLE	0 204 125 531	
		ABO 08.94-03.97	51/56/63/84	LLE	0 204 125 101	
				LLE,Z9	0 204 125 127	
	2.5 D	04.97-08.00	51/56/63/84	LLE	0 204 125 531	
	2.5 DI	ABO 08.94-03.97	51/56/63/84	LLE	0 204 125 101	
	2.5 TD			LLE,Z9	0 204 125 127	
	2.5 TDI	03.99-08.00	85	LLE	0 204 125 531	

	2.0i	08.94-07.00	84	Org.Nr. Typ 80,100S,120	BRD	0 204 131 359 ¹⁰
					BRV	0 204 131 354 ¹⁰
				Org.Nr. Typ 100L-150L,150S	BRV	0 204 131 356 ¹⁰
				Org.Nr. Typ 130/150S/150L	BRV	0 204 131 368 ¹⁰
	2.5 D	08.94-08.00	51/56/63/	Org.Nr. Typ 80,100S,120	BRD	0 204 131 367 ¹⁰
	2.5 DI		85		BRV	0 204 031 299 ¹⁰
	2.5 TD			Org.Nr. Typ 100L-150L,150S	BRD	0 204 131 360 ¹⁰
	2.5 TDI				BRV	0 204 031 298 ¹⁰

	2.0i	08.94-08.00	51/56/63/	OZB	1 987 477 369	2823
	2.5 D, DI, TD, TDI		84/85	ZWB	1 987 477 370	2730

	2.0i	11.97-08.00	51/84		0 265 220 468 ¹⁸	
	2.5 D					
	2.5 DI	11.97-08.00	56		0 265 220 468 ¹⁸	
		ABS, 11.97-08.00	56	AK	0 265 216 625 ¹⁶	
		OAS				
	2.5 TD, TDI	11.97-08.00	63/85		0 265 220 468 ¹⁸	













	2.0i	11.97-08.00	51/84		1 273 004 260 ¹⁸	
	2.5 D					
	2.5 DI	11.97-08.00	56		1 273 004 260 ¹⁸	
		ABS, 11.97-08.00	56	AK	1 273 004 340 ¹⁶	
		OAS				
	2.5 TD, TDI	11.97-08.00	63/85		1 273 004 260 ¹⁸	

Transit Nugget [F_ _ _]



	2.0 TDCi	08.00-07.03	74/92		1 987 481 045	475
	2.0 TDE					← 475
					1 987 481 070	→ 478
		08.03-07.06	74/92		1 987 481 046	410
						← 410
					1 987 481 047	→ 410









		S							
◀ FORD Transit Nugget [F_ _]									
	2.0 TDCi	08.00-07.06	74/92				0 204 204 992	← 48	0 204 201 289 ⁸
	2.0 TDE						0986 473 272		0 204 201 476
							0 204 204 993	→ 48	0 204 201 289 ⁸
							0986 474 272		
	2.0 TDCi	08.00-07.06	74/92				1987 481 072 ¹	375	
	2.0 TDE								
	2.0 TDCi	08.00-07.06	74/92				F 026 002 578	↔ 25,4	
	2.0 TDE								
	2.0 TDCi	ABO 08.00-07.06	74/92				0 204 024 070	25,4	
	2.0 TDE	ABS 08.00-07.06	74/92				0 204 024 071	25,4	
	2.0 TDCi	08.00-07.03	74/92		RLE		0 204 024 181		
	2.0 TDE								
	2.0 TDCi	08.00-07.06	74/92		KZB,KZE		0 204 131 703 ¹⁰		
	2.0 TDE	12.02-02.04	74/92		KZB,KZW		0 204 131 702 ¹⁰		
		12.02-07.06	74/92		KW2		0 204 131 711 ¹⁰		
					KZS,KZW		0 204 131 705 ¹⁰		
					KZW,ORA		0 204 131 704 ¹⁰		
		02.04-07.06	74/92		KZW,RSA		0 204 131 710 ¹⁰		
	2.0 TDCi	08.00-07.06	74/92				1987 477 174	← 1547	
	2.0 TDE						1987 482 036	→ 1283	
					LLE		1987 477 186	1052	
					RLE		1987 477 190	910	
	2.0 TDCi	08.00-07.06	74/92				0 265 220 539 ¹⁴		
	2.0 TDE								
	2.0 TDCi	08.00-05.04	74/92		LAB,TW		0 265 006 818 ⁴		
	2.0 TDE	08.00-07.06	74/92		RAB,TW		0 265 006 817 ⁴		
					TW		0 265 006 458 ³		
		07.03-07.06	74/92		LAB,TW		0 265 006 784 ⁴		
					TW		0 265 006 784 ³		
		11.03-05.04	74/92		RAB,TW		0 265 006 460 ⁴		
	05.04-07.06	74/92		RAB,TW		0 265 006 811 ⁴			
Transit [T_ _]									
	1.6 100 L	01.86-08.89	46/55-57		EIZ		1987 476 512	→ 275	
							1987 476 513	← 275	
		01.86-07.91	46/55-57		ZWZ		1987 476 514	→ 275	
						1987 476 515	← 275		
	1.6 130-190	01.86-07.91	46/55-57		ZWZ		1987 476 514	→ 275	
							1987 476 515	← 275	
	1.6 80-120	01.86-07.91	46/55-57				1987 476 510	→ 430	
							1987 476 511	← 430	

	S							
2.0i 80-120	10.88-07.91	46/55-57				1 987 476 510	→ 430	
						1 987 476 511	← 430	
2.0i 100L	10.88-08.89	46/55-57		EIZ		1 987 476 512	→ 275	
						1 987 476 513	← 275	
	10.88-07.91	46/55-57		ZWZ		1 987 476 514	→ 275	
						1 987 476 515	← 275	
2.0i 130-190	10.88-07.91	46/55-57		ZWZ		1 987 476 514	→ 275	
						1 987 476 515	← 275	
2.0 100L	01.86-08.89	46/55-57		EIZ		1 987 476 512	→ 275	
						1 987 476 513	← 275	
	01.86-07.91	46/55-57		ZWZ		1 987 476 514	→ 275	
						1 987 476 515	← 275	
2.0 130-190	01.86-07.91	46/55-57		ZWZ		1 987 476 514	→ 275	
						1 987 476 515	← 275	
2.0 80-120	01.86-07.91	46/55-57				1 987 476 510	→ 430	
						1 987 476 511	← 430	
2.5 D 80-120	01.86-07.91	50-52				1 987 476 510	→ 430	
						1 987 476 511	← 430	
2.5 D 100L	01.86-08.89	50-52		EIZ		1 987 476 512	→ 275	
						1 987 476 513	← 275	
	01.86-07.91	50-52		ZWZ		1 987 476 514	→ 275	
						1 987 476 515	← 275	
2.5 D 130-190	01.86-07.91	50-52		ZWZ		1 987 476 514	→ 275	
						1 987 476 515	← 275	
 2.5 D 80-120	01.86-07.91	50-52			BUS,LWG WIF			0 204 104 135 ⁷ 0 204 104 135
								
 1.6 100L, 130-190, 80-120	01.86-07.91	46/50-52/			BRD	1 987 476 615 ¹	415	
2.0i 80-120, i 100L, i 130-190		55-57			BRV	1 987 476 614 ¹	447	
2.0 100L, 130-190, 80-120								
2.5 D 80-120, D 100L, D 130-190								
 1.6 100L	01.86-07.91	46/55-57	Org.Nr. TYP 80-120	PW		0 986 475 742	↔ 20,6	
			Org.Nr. TYP 100L			0 986 475 701	← 22,19	
						0 986 475 702	→ 22,19	
			Org.Nr. TYP 100L,			0 986 475 703	← 23,8	
			Org.Nr. TYP 130,			0 986 475 704	→ 23,8	
			Org.Nr. TYP 160,					
			Org.Nr. TYP 190					
	01.88-07.91	46/55-57				0 986 475 824	→ 20,3	
						0 986 475 825	← 20,3	
1.6 130-190	01.86-07.91	46/55-57	Org.Nr. TYP 100L,			0 986 475 703	← 23,8	
			Org.Nr. TYP 130,			0 986 475 704	→ 23,8	
			Org.Nr. TYP 160,					
			Org.Nr. TYP 190					
			Org.Nr. TYP 130,			0 986 475 821	→ 25,4	
			Org.Nr. TYP 160,			0 986 475 822	← 25,4	
			Org.Nr. TYP 190					
	05.89-07.91	46/55-57	Org.Nr. TYP 130,			0 986 475 824	→ 20,3	
			Org.Nr. TYP 160,			0 986 475 825	← 20,3	
			Org.Nr. TYP 190					



		S								
◀ FORD Transit [T_...]										
1.6 80-120	01.86-07.91	46/55-57	Org.Nr. TYP 80-120	PW	0986 475 742	↔ 20,6				
			Org.Nr. TYP 100L		0986 475 701	← 22,19				
					0986 475 702	→ 22,19				
			Org.Nr. TYP 100L, Org.Nr. TYP 130, Org.Nr. TYP 160, Org.Nr. TYP 190		0986 475 703	← 23,8				
					0986 475 704	→ 23,8				
			Org.Nr. TYP 130, Org.Nr. TYP 160, Org.Nr. TYP 190		0986 475 821	→ 25,4				
					0986 475 822	← 25,4				
2.0 i80-120	10.88-07.91	46/55-57	Org.Nr. TYP 80-120	PW	0986 475 742	↔ 20,6				
			Org.Nr. TYP 100L		0986 475 701	← 22,19				
					0986 475 702	→ 22,19				
			Org.Nr. TYP 100L, Org.Nr. TYP 130, Org.Nr. TYP 160, Org.Nr. TYP 190		0986 475 703	← 23,8				
					0986 475 704	→ 23,8				
			Org.Nr. TYP 130, Org.Nr. TYP 160, Org.Nr. TYP 190		0986 475 821	→ 25,4				
					0986 475 822	← 25,4				
2.0 i 100L	10.88-07.91	46/55-57			0986 475 824	→ 20,3				
					0986 475 825	← 20,3				
			Org.Nr. TYP 80-120	PW	0986 475 742	↔ 20,6				
			Org.Nr. TYP 100L		0986 475 701	← 22,19				
					0986 475 702	→ 22,19				
			Org.Nr. TYP 100L, Org.Nr. TYP 130, Org.Nr. TYP 160, Org.Nr. TYP 190		0986 475 703	← 23,8				
					0986 475 704	→ 23,8				
Org.Nr. TYP 130, Org.Nr. TYP 160, Org.Nr. TYP 190	0986 475 821	→ 25,4								
	0986 475 822	← 25,4								
2.0 i 130-190	10.88-07.91	46/55-57	Org.Nr. TYP 100L, Org.Nr. TYP 130, Org.Nr. TYP 160, Org.Nr. TYP 190		0986 475 703	← 23,8				
					0986 475 704	→ 23,8				
			Org.Nr. TYP 130, Org.Nr. TYP 160, Org.Nr. TYP 190	0986 475 821	→ 25,4					
				0986 475 822	← 25,4					
	05.89-07.91	46/55-57	Org.Nr. TYP 130, Org.Nr. TYP 160, Org.Nr. TYP 190		0986 475 824	→ 20,3				
					0986 475 825	← 20,3				
	2.0 100L	01.86-07.91	46/55-57	Org.Nr. TYP 80-120	PW	0986 475 742	↔ 20,6			
Org.Nr. TYP 100L				0986 475 701		← 22,19				
				0986 475 702		→ 22,19				
Org.Nr. TYP 100L, Org.Nr. TYP 130, Org.Nr. TYP 160, Org.Nr. TYP 190		0986 475 703	← 23,8							
		0986 475 704	→ 23,8							
01.88-07.91		46/55-57				0986 475 824	→ 20,3			
						0986 475 825	← 20,3			
2.0 130-190	01.86-07.91	46/55-57	Org.Nr. TYP 100L, Org.Nr. TYP 130, Org.Nr. TYP 160, Org.Nr. TYP 190		0986 475 703	← 23,8				
					0986 475 704	→ 23,8				
			Org.Nr. TYP 130, Org.Nr. TYP 160, Org.Nr. TYP 190	0986 475 821	→ 25,4					
				0986 475 822	← 25,4					
	05.89-07.91	46/55-57	Org.Nr. TYP 130, Org.Nr. TYP 160, Org.Nr. TYP 190		0986 475 824	→ 20,3				
					0986 475 825	← 20,3				



		S									
2.0 80-120		01.86-07.91	46/55-57	Org.Nr. TYP 80-120	PW		0 986 475 742	↔ 20,6			
				Org.Nr. TYP 100L			0 986 475 701	← 22,19			
							0 986 475 702	→ 22,19			
				Org.Nr. TYP 100L, Org.Nr. TYP 130, Org.Nr. TYP 160, Org.Nr. TYP 190			0 986 475 703	← 23,8			
							0 986 475 704	→ 23,8			
				Org.Nr. TYP 130, Org.Nr. TYP 160, Org.Nr. TYP 190			0 986 475 821	→ 25,4			
			0 986 475 822	← 25,4							
2.5 D 80-120		01.86-07.91	50-52	Org.Nr. TYP 80-120	PW		0 986 475 742	↔ 20,6			
				Org.Nr. TYP 100L			0 986 475 701	← 22,19			
							0 986 475 702	→ 22,19			
				Org.Nr. TYP 100L, Org.Nr. TYP 130, Org.Nr. TYP 160, Org.Nr. TYP 190			0 986 475 703	← 23,8			
							0 986 475 704	→ 23,8			
2.5 D 100L		01.86-09.88	52	Org.Nr. TYP 80-120	PW		0 986 475 742	↔ 20,6			
				Org.Nr. TYP 130, Org.Nr. TYP 160, Org.Nr. TYP 190			0 986 475 821	→ 25,4			
							0 986 475 822	← 25,4			
				01.88-09.88	52				0 986 475 824	→ 20,3	
								0 986 475 825	← 20,3		
				10.88-07.91	50-52			0 986 475 824	→ 20,3		
								0 986 475 825	← 20,3		
						Org.Nr. TYP 80-120	PW		0 986 475 742	↔ 20,6	
					Org.Nr. TYP 100L	0 986 475 701			← 22,19		
						0 986 475 702			→ 22,19		
						Org.Nr. TYP 100L, Org.Nr. TYP 130, Org.Nr. TYP 160, Org.Nr. TYP 190			0 986 475 703	← 23,8	
									0 986 475 704	→ 23,8	
2.5 D 130-190		01.86-09.88	52	Org.Nr. TYP 100L, Org.Nr. TYP 130, Org.Nr. TYP 160, Org.Nr. TYP 190			0 986 475 703	← 23,8			
							0 986 475 704	→ 23,8			
									0 986 475 821	→ 25,4	
									0 986 475 822	← 25,4	
				10.88-07.91	50-52	Org.Nr. TYP 100L, Org.Nr. TYP 130, Org.Nr. TYP 160, Org.Nr. TYP 190			0 986 475 703	← 23,8	
									0 986 475 704	→ 23,8	
						Org.Nr. TYP 130, Org.Nr. TYP 160, Org.Nr. TYP 190			0 986 475 821	→ 25,4	
									0 986 475 822	← 25,4	
				05.89-07.91	50-52	Org.Nr. TYP 130, Org.Nr. TYP 160, Org.Nr. TYP 190			0 986 475 824	→ 20,3	
									0 986 475 825	← 20,3	
2.9 V6 3.0 V6		01.86-07.91	78/110	Org.Nr. TYP 80-120	PW		0 986 475 742	↔ 20,6			
				Org.Nr. TYP 100L			0 986 475 701	← 22,19			
							0 986 475 702	→ 22,19			
				Org.Nr. TYP 100L, Org.Nr. TYP 130, Org.Nr. TYP 160, Org.Nr. TYP 190			0 986 475 703	← 23,8			
							0 986 475 704	→ 23,8			
				Org.Nr. TYP 130, Org.Nr. TYP 160, Org.Nr. TYP 190			0 986 475 821	→ 25,4			
					0 986 475 822	← 25,4					
				05.89-07.91	78/110	Org.Nr. TYP 130, Org.Nr. TYP 160, Org.Nr. TYP 190			0 986 475 824	→ 20,3	
									0 986 475 825	← 20,3	



		S							
◀ FORD Transit [T_]									
	1.6 100 L, 130-190, 80-120	01.86-07.91	46/50-52/	BHO	0 204 123 083	22			
	2.0 i 80-120, i 100 L, i 130-190		55-57/78/	FCC,KBG	F 026 003 084	23,8			
	2.0 100 L, 130-190, 80-120		110	KM2	0 204 123 077	22			
	2.5 D 80-120, D 100 L, D 130-190			WIF	F 026 003 085	23,8			
	2.9 V6								
	3.0 V6								
	1.6 100 L, 130-190, 80-120	01.86-07.91	46/50-52/	TP1	0 986 485 086				
	2.0 i 80-120, i 100 L, i 130-190		55-57/78/	TP2	0 986 485 087				
	2.0 100 L, 130-190, 80-120		110	TP3	0 204 125 051				
	2.5 D 80-120, D 100 L, D 130-190			TP4	0 204 125 052				
	2.9 V6								
	3.0 V6								
	2.5 D 100 L, D 130-190	03.88-04.89	50-52	TW	0 986 482 010 ¹⁰				
	1.6 80-120	01.86-07.91	46/50-52/	ABM	1 987 477 101	2973			
	2.0 i 80-120, 80-120		55-57						
	2.5 D 80-120								
	2.9 V6	01.86-07.91	78/110	ABM,TW	1 987 477 101	2973			
	3.0 V6								
Transit Tourneo									
	2.2 TDCi	04.06→	81/85/96/103		0 204 004 617	← 48			
					0 204 004 618	→			
	2.2 TDCi	04.06→	81/85/96/103		F 026 002 578	↔ 25,4			
	2.2 TDCi	04.06→	81/85/96/103		0 204 902 026	← 48			
					0 204 902 027	→ 48			
	2.2 TDCi	ABO 04.06→	81/85/96/103		0 204 123 717	25,4			
		ABS 04.06→	81/85/96/103		0 204 123 716	25,4			
	2.2 TDCi	04.06→	81/85/96/103		0 204 125 857		0 204 127 528		
	2.2 TDCi	04.06→	81/85/96/103	KZB,KZE	0 204 131 703 ¹⁰				
				KZB,KZW	0 204 131 702 ¹⁰				



	2.2 TDCi	04.06→	81		0 265 231 704 ¹¹	
					0 265 233 341 ¹⁴	
				MBH	0 265 234 354 ²⁶	
		96/103		0 265 231 704 ¹¹		
				0 265 233 341 ¹⁴		
			MBH	0 265 234 354 ²⁶		
	10.08→	85		0 265 231 704 ¹¹		
				0 265 233 341 ¹⁴		

	2.2 TDCi	04.06→	81/85/96/103	TW	0 265 005 690	
--	----------	--------	--------------	----	---------------	--

Transit Tourneo [E_ _]



	2.0i	08.94-09.99	51/56/63/84		1 987 476 510	→ 430
					1 987 476 511	← 430
		ABS, 10.99-07.00	51/56/63/84		1 987 476 510	→ 430
		OAS			1 987 476 511	← 430
	2.5 D, DI, TD	ABS, 10.99-08.00	51/56/63/84		1 987 476 510	→ 430
					1 987 476 511	← 430
	2.5 D, DI, TD, TDI	08.94-09.99	51/56/63/84		1 987 476 510	→ 430
					1 987 476 511	← 430
	2.5 TDI	03.99-09.99	85		1 987 476 510	→ 430
					1 987 476 511	← 430
ABS, 10.99-08.00				63/85	1 987 476 510	→ 430
OAS					1 987 476 511	← 430

	2.0i	08.94-08.00	51/56/63/84/85	5LO	0 204 102 925	→ 42	0 204 104 135 ⁷	
					0 204 103 925	↻		
	2.5 DI					0 204 102 926	← 42	0 204 104 135 ⁷
						0 204 103 926	↻	
	2.5 TDI				6LO	0 204 102 934	→ 42	0 204 104 135 ⁷
						0 204 102 935	← 42	0 204 104 135 ⁷



	2.0i	08.94-07.00	51/56/63/84	BRV	1 987 476 614	447		
				ABS, 08.94-07.00	51/56/63/84	BRD	1 987 476 615	415
						OAS		
	2.5 D, DI, TD	ABS, 08.94-08.00	51/56/63/84	BRD	1 987 476 615	415		
				OAS				
	2.5 D, DI, TD, TDI	08.94-08.00	51/56/63/84	BRV	1 987 476 614	447		
	2.5 TDI	03.99-08.00	85	BRV	1 987 476 614	447		
				ABS, 08.94-08.00	63/85	BRD	1 987 476 615	415
	OAS							

	2.0i	08.94-08.00	51/56/63/84/85		F 026 002 171	↔ 20,6
	2.5 D, DI, TD, TDI				F 026 002 172	↔ 22,19



	2.0i	ABO 08.94-03.97	51/56/63/84		F 026 003 136	23,8
					F 026 003 354	23,8
		ABS 04.97-07.00	51/56/63/84		0 204 123 355	23,8
					0 204 123 355	23,8
		2.5 D, DI, TD	ABS 04.97-08.00	51/56/63/84		0 204 123 355





FORD Transit Tourneo [E_ _]

	2.5 D, DI, TD, TDI	ABO	08.94-03.97	51/56/63/84		F 026	003 136	23,8
			04.97-08.00	51/56/63/84		F 026	003 354	23,8
	2.5 TDI	ABO	03.99-08.00	85		F 026	003 354	23,8
		ABS	04.97-08.00	63/85		0 204	123 355	23,8

	2.0 i		04.97-07.00	51/56/63/84	LLE	0 204	125 531	
		ABO	08.94-03.97	51/56/63/84	LLE	0 204	125 101	
					LLE,Z9	0 204	125 127	
	2.5 D, DI, TD	ABO	08.94-03.97	51/56/63/84	LLE	0 204	125 101	
					LLE,Z9	0 204	125 127	
	2.5 D, DI, TD, TDI		04.97-08.00	51/56/63/84	LLE	0 204	125 531	
	2.5 TDI		03.99-08.00	85	LLE	0 204	125 531	
		ABO	08.94-03.97	63	LLE	0 204	125 101	
					LLE,Z9	0 204	125 127	

	2.0 i		08.94-07.00	84	Org.Nr. Typ 80,100S,120	BRD	0 204	131 359 ¹⁰	
						BRV	0 204	131 354 ¹⁰	
					Org.Nr. Typ 100L-150L,150S	BRV	0 204	131 356 ¹⁰	
					Org.Nr. Typ 130/150S/150L	BRV	0 204	131 368 ¹⁰	
	2.5 D		08.94-08.00	51/56/63/	Org.Nr. Typ 80,100S,120	BRD	0 204	131 367 ¹⁰	
				85		BRV	0 204	031 299 ¹⁰	
	2.5 DI					BRD	0 204	131 360 ¹⁰	
						BRV	0 204	031 298 ¹⁰	























	2.0 i		08.94-08.00	51/56/63/		OZB	1 987	477 369	2823
				84/85		ZWB	1 987	477 370	2730
	2.0 i		11.97-08.00	51/84			0 265	220 468 ¹⁸	
		2.5 D							
	2.5 DI		11.97-08.00	56			0 265	220 468 ¹⁸	
		ABS, OAS	11.97-08.00	56		AK	0 265	216 625 ¹⁶	
	2.5 TD, TDI		11.97-08.00	63/85			0 265	220 468 ¹⁸	

	2.0 i		11.97-08.00	51/84			1 273	004 260 ¹⁸	
		2.5 D							
	2.5 DI		11.97-08.00	56			1 273	004 260 ¹⁸	
		ABS, OAS	11.97-08.00	56		AK	1 273	004 340 ¹⁶	
	2.5 TD, TDI		11.97-08.00	63/85			1 273	004 260 ¹⁸	

Transit Tourneo [F_ _ _]

	2.0 TDCi		08.00-07.03	74/92			1 987	481 045	475
		2.0 TDE							← 475
							1 987	481 070	→ 478
			08.03-07.06	74/92			1 987	481 046	410
									← 410
							1 987	481 047	→ 410

	2.0 TDCi		08.00-07.06	74/92			0 204	204 992	← 48	0 204 201 289 ⁸
		2.0 TDE						0 986	473 272	→ 48
							0 204	204 993	→ 48	0 204 201 289 ⁸
							0 986	474 272	→ 48	

		S							
									
	2.0 TDCi 2.0 TDE	08.00-07.06	74/92				1 987 481 072 ¹	375	
	2.0 TDCi 2.0 TDE	08.00-07.06	74/92				F 026 002 578	↔ 25,4	
									
	2.0 TDCi 2.0 TDE	ABO 08.00-07.06 ABS 08.00-07.06	74/92 74/92				0 204 024 070 0 204 024 071	25,4 25,4	
	2.0 TDCi 2.0 TDE	08.00-07.03	74/92			RLE	0 204 024 181		
	2.0 TDCi 2.0 TDE	08.00-07.06 12.02-02.04 12.02-07.06 02.04-07.06	74/92 74/92 74/92 74/92			KZB,KZE KZB,KZW KW2 KZS,KZW KZW,RSA	0 204 131 703 ¹⁰ 0 204 131 702 ¹⁰ 0 204 131 711 ¹⁰ 0 204 131 705 ¹⁰ 0 204 131 710 ¹⁰		
	2.0 TDCi 2.0 TDE	08.00-07.06	74/92				1 987 477 174 1 987 482 036 LLE 1 987 477 186 RLE 1 987 477 190	← 1547 → 1283 1052 910	
	2.0 TDCi 2.0 TDE	08.00-07.06	74/92				0 265 220 539 ¹⁴		
	2.0 TDCi 2.0 TDE	08.00-05.04 08.00-07.06 07.03-07.06 11.03-05.04 05.04-07.06	74/92 74/92 74/92 74/92 74/92			LAB,TW RAB,TW TW LAB,TW TW RAB,TW RAB,TW	0 265 006 818 ⁴ 0 265 006 817 ⁴ 0 265 006 458 ³ 0 265 006 784 ⁴ 0 265 006 784 ³ 0 265 006 460 ⁴ 0 265 006 811 ⁴		
HOLDEN									
Crewman [VZ]									
									
	3.6 i	09.04-08.06	175			TKO	0 265 231 036 ¹⁶		
Utility [VS III]									
									
	3.8 i	05.98-12.00	147			CSA,LAB, STF STF	0 265 006 229 ⁴ 0 265 006 227 ⁴		





Utility [VZ]

	3.6 i	09.04-08.07	175		TKØ	0 265	231 036 ¹⁶

HYUNDAI

Grace

	2.4 i Super	10.95→	59/63/90			1 987	481 039	295
	2.5 D					1 987	481 039 ¹	295
	2.5 Intercooler				BAB	1 987	481 009	180
						1 987	481 009 ²	180

	2.4 i Super	10.95→	59/63/90		BUS,FKR	0 986	475 957	← 19
	2.5 D					0 986	475 958	→ 19
	2.5 Intercooler							

	2.4 i Super	10.95→	59/63/90			0 265	103 072 ¹⁶	
	2.5 D							
	2.5 Intercooler							

H 100

	2.4 i	02.93-03.00	55/57/59/			1 987	481 039	295
	2.5 D		90			1 987	481 039 ¹	295
	2.5 Intercooler				BAB	1 987	481 009	180
						1 987	481 009 ²	180
	2.5 TCI	09.96→	63/70			1 987	481 009	180
						1 987	481 009 ²	180
						1 987	481 039	295
						1 987	481 039 ¹	295

	2.4 i	02.93-03.00	55/57/59/		BUS,FKR	0 986	475 957	← 19
	2.5 D, Intercooler		90			0 986	475 958	→ 19
	2.5 TD	07.93-03.00	59			0 986	475 959	← 22,19
						0 986	475 960	→ 22,19

	2.4 i	02.93-03.00	55/57/59/			0 265	103 072 ¹⁶	
	2.5 D		90					
	2.5 Intercooler							

	2.5 D	02.93-12.94	55		CSA,LAB	0 265	006 133 ³	





H-1



	2.4i	10.97-03.98	57/82	0 986 475 959	← 22,19
	2.5D			0 986 475 960	→ 22,19
	2.5TCi	10.99-12.06	73-74	0 986 475 959	← 22,19
				0 986 475 960	→ 22,19

Satellite



	2.4i	10.97-03.98	82	0 986 475 959	← 22,19
				0 986 475 960	→ 22,19
		04.98-05.07	82	0 986 475 959	← 22,19
				0 986 475 960	→ 22,19
	2.4i 4WD	10.97-03.98	82	0 986 475 959	← 22,19
				0 986 475 960	→ 22,19
		04.98-05.07	82	0 986 475 959	← 22,19
				0 986 475 960	→ 22,19
	2.5D Turbo	10.97-03.98	63	0 986 475 959	← 22,19
				0 986 475 960	→ 22,19
		04.98-08.02	63	0 986 475 959	← 22,19
				0 986 475 960	→ 22,19
	2.5D Turbo 4WD	10.97-03.98	63	0 986 475 959	← 22,19
				0 986 475 960	→ 22,19
		04.98-08.02	63	0 986 475 959	← 22,19
				0 986 475 960	→ 22,19

Starex



	2.4i	10.97-03.98	82-86	0 986 475 959	← 22,19
				0 986 475 960	→ 22,19
		04.98-05.07	82-86	0 986 475 959	← 22,19
				0 986 475 960	→ 22,19
	2.4i 4WD	10.97-03.98	82-86	0 986 475 959	← 22,19
				0 986 475 960	→ 22,19
		04.98-05.07	82-86	0 986 475 959	← 22,19
				0 986 475 960	→ 22,19
	2.5D	10.97-03.98	57	0 986 475 959	← 22,19
				0 986 475 960	→ 22,19
		04.98-08.02	57	0 986 475 959	← 22,19
				0 986 475 960	→ 22,19
	2.5D Turbo	10.97-03.98	59	0 986 475 959	← 22,19
				0 986 475 960	→ 22,19
		04.98-08.02	59	0 986 475 959	← 22,19
				0 986 475 960	→ 22,19
	2.5D Turbo 4WD	10.97-03.98	59	0 986 475 959	← 22,19
				0 986 475 960	→ 22,19
		04.98-08.02	59	0 986 475 959	← 22,19
				0 986 475 960	→ 22,19





INFINITI

Serie FX [S51]

	35 4x4	09.08→	228			0 265 005 693	
	35 4x4	09.08→	228			0 265 005 515	

INNOCENTI (NUOVA INNOCENTI)

Elba

	1.7 D	09.92-12.96	42			F 026 002 454	↔ 19,05
	1.7 D	09.92-12.96	42			1 987 477 296	2828

ISUZU

Pick-Up [KB]

	2.2 D	08.86-12.90	39	Fg.Nr. C*6206726→	TW	0 986 475 807	↔ 25,4

Serie N

	NQR500 5.2	02.08→	110			F 01G 29L 01N	

Serie N [700N]

	NLR150T 2.9 Carrier	09.08→	96			F 01G 19C 02T	F 01G 09C 138
	NPR400 5.2	09.08→	110			F 01G 29L 01N	
	NLR150T 2.9 Carrier	09.08→	96			F 01G 061 0PY	





IVECO

A

	70-14 90-14	05.88-06.91	101	TW	F 026 003 179 F 026 003 980	27 28,57
	60-9	09.88-12.92	65	TW	0 204 125 305	
	60-9 90-14	05.88-12.92	65/101		F 026 005 075	

CityClass

		10.05-07.07	92		0 204 123 413	
		10.05-07.07	92		0 204 125 519	

Daily

	60.12	10.02-07.07	90		0 204 123 413	
	C 50 C 11, 50 C 13, 50 C 14 C 50 C 15, 50 C 17 60.12	05.99-08.06 10.02-07.07	78/92/100/ 108/122 90		0 204 021 854 ²⁵ 0 204 125 519	

Daily Chassi

	S 35 S 14, 45 S 14 35.13 40.13 50.13 70.13	10.05→	92/100		F 026 003 140	25,4
	35.13 40.13 50.13 70.13	10.05-07.07	92		0 204 125 266	
	C 55 C 16 S 35 S 14 S 45 S 14	08.07→	100/114		0 204 031 119	





◀ IVECO Daily Chassi

	35.13 40.13 50.13	10.05-07.07	92		1987 482 148	1475
--	-------------------------	-------------	----	--	---------------------	------

Daily Furgao



	S 35 S 14, 45 S 14 38.13 40.13 50.13	10.05→	92/100-114		F 026 003 140	25,4
--	---	--------	------------	--	----------------------	------

	38.13 40.13 50.13	10.05-07.07	92		0 204 125 266	
--	-------------------------	-------------	----	--	----------------------	--

	C 55 C 16 S 35 S 14 S 45 S 14	08.07→	100-114		0 204 031 119	
--	-------------------------------------	--------	---------	--	----------------------	--





















	38.13 40.13 50.13	10.05-07.07	92		1987 482 148	1475
--	-------------------------	-------------	----	--	---------------------	------

Daily, Grinta



	Duty 35-8 New Daily 30-8, 35-8, 35-10 Turbo New Daily 35-10 Turbo I.D., 40-8 New Daily 40-10 Turbo 4x4 Restyling 35-10 Turbo Turbo Daily 30-10 Turbo Turbo Daily 35-10 Turbo	02.85-03.98 05.96-05.99 07.92-04.97	55/60/ 66,1-68,9/ 70/76/80 76 80		F 026 003 149 F 026 003 149 F 026 003 149 F 026 003 149 R14 F 026 003 149 R16 F 026 003 140 R14 F 026 003 149 R16 F 026 003 140	20,6 20,6 20,6 20,6 20,6 25,4 20,6 25,4
--	--	---	--	--	--	--

	Duty 35-8 New Daily 40-8 New Daily A45-10 Turbo New Daily 30-8, 35-8 New Daily 35-10 Turbo	07.89-04.96 07.89-04.96 02.91-03.98 ABO 05.85-09.90	55 76 55/60 70		0 204 125 393 0 204 125 459 0 204 125 393 FFZ,OZB 0 204 125 318 FFZ,ZWB 0 204 125 299 0 204 125 393 ²⁵ 09.89-04.96 76 FFZ 0 204 125 391 ²⁵ FFZ,OZB 0 204 125 318 FFZ,ZWB 0 204 125 299 0 204 125 393 ²⁵ 07.91-04.96 66,1-68,9 FFZ,OZB 0 204 125 318 FFZ,ZWB 0 204 125 299 0 204 125 393 ²⁵ 01.93-05.96 77,5-83 FFZ,OZB 0 204 125 318 FFZ,ZWB 0 204 125 299 0 204 125 393 ²⁵ ABS 05.85-05.96 66,1-68,9/70/76/77,5-83 0 204 125 459 ²⁵ New Daily 35-10 Turbo I.D. ABO 07.92-04.97 80 FFZ,OZB 0 204 125 318 FFZ,ZWB 0 204 125 299 0 204 125 393 ²⁵ ABS 07.92-04.97 80 0 204 125 459 ²⁵
--	--	--	-------------------------	--	--























		S							
	Restyling 45-10 Turbo, 49-10 Turbo	02.85-06.89	67				0 204 125 333		
	Turbo Daily A40-10 Turbo	06.90-05.99	76/85/90				0 204 125 459		
	Turbo Daily A45-10 Turbo								
	Turbo Daily A49-10 Turbo								
	Turbo Daily 35-12 Turbo								
	Turbo Daily 49-12 Turbo								
	Turbo Daily 59-12 Turbo	05.91-05.99	85/90				0 204 125 430		
	Turbo Daily 35-10 Turbo	07.92-05.99	76/80			STB	0 204 131 236		
	ABS	07.92-05.99	76/80				0 204 131 217		
	New Daily A45-10 Turbo, 30-8	02.90-04.97	55/66,1-68,9/76/80/85				0 265 105 020 ¹⁶		
	New Daily 35-8, 35-10 Turbo								
	New Daily 35-10 Turbo I.D., 40-8								
	New Daily 40-10 Turbo 4x4								
	Turbo Daily A45-12 Turbo								
	Turbo Daily 35-12 Turbo								
	Turbo Daily 49-12 Turbo								
	Turbo Daily 59-12 Turbo								
	New Daily A45-10 Turbo, 30-8	07.89-04.97	55/66,1-68,9/76/80/85				0 265 050 012 ³		
	New Daily 35-8, 35-10 Turbo	02.90-02.96	55/66,1-68,9/76/80/85				0 265 050 029 ⁴		
	New Daily 35-10 Turbo I.D., 40-8								
	New Daily 40-10 Turbo 4x4								
	Turbo Daily A45-12 Turbo								
	Turbo Daily 35-10 Turbo	07.92-05.99	76/80	Fg.Nr. →5115972			0 265 050 026 ⁴		
	Turbo Daily 35-12 Turbo	06.90-02.96	85				0 265 050 029 ⁴		
	Turbo Daily 49-12 Turbo	06.90-04.96	85				0 265 050 012 ³		
	Turbo Daily 59-12 Turbo								
Daily Maxivan									
	 								
	S 40 S 16	08.07→	114				F 026 003 140	25,4	
	C 55 C 16 S 40 S 16	08.07→	114				0 204 031 119		
Daily MaxiVan									
	 								
	40 .13	10.05-07.07	92				F 026 003 140	25,4	
	40 .13	10.05-07.07	92				0 204 125 266		
	40 .13	10.05-07.07	92				1 987 482 148	1475	



EuroCargo



	60 E 10, E 12, E 14 65 E 10, E 12, E 14 75 E 12, E 14, E 15 80 E 15, E 18, E 21 100 E 15, E 18, E 21 150 E 15, E 18, E 23, E 27 180 E 21	01.91-06.96	75/85/100		0 204 122 187	33,34
	135 E 18 135 E 23 260 E 23 280 E 23	01.94-07.00 01.94-07.00 12.91-11.00	130 167 167		0 204 162 071 0 204 162 071 F 026 005 084	
	60 E 10, E 12, E 14 65 E 10, E 12, E 14 75 E 12, E 14, E 15 80 E 15, E 18, E 21 95 E 21 100 E 15, E 18, E 21 120 E 15, E 18, E 23 130 E 15, E 18, E 23 135 E 18, E 23 150 E 15 150 E 18, E 23, E 27 170 E 18, E 23 180 E 21 260 E 23 280 E 23	01.91-12.00 09.91-11.00	75/85/100/ 105/130/ 152/167/ 196 75/85/100/ 105/130/ 152/167/ 196		F 026 005 564 F 026 005 564	
	60 E 10, E 12, E 14 65 E 10, E 12, E 14 75 E 12, E 14, E 15 80 E 15, E 18, E 21 100 E 15, E 18, E 21 120 E 15, E 18, E 23 130 E 15, E 18, E 23 135 E 18, E 23 150 E 15, E 18, E 23, E 27 180 E 21 260 E 23 280 E 23 320 E 27	04.92-12.92 04.92-11.00 04.92-11.00 10.91-08.00	75/85/100/ 105 105/130/ 152 105/130/ 152/167/ 196	THE THE THE THE	0 265 150 307 ¹⁸ 0 265 150 307 ¹⁸ 0 265 150 308 ¹⁸ 0 265 150 308 ¹⁸	
	60 E 10, E 12, E 14 65 E 10, E 12, E 14 75 E 12, E 14, E 15 80 E 15, E 18, E 21 100 E 15, E 18, E 21 120 E 15, E 18, E 23 130 E 15, E 18, E 23 135 E 18, E 23 150 E 15, E 18, E 23, E 27 180 E 21 260 E 23 280 E 23 320 E 27	04.92-12.92 04.92-11.00 10.91-08.00	75/85/100/ 105 105/130/ 152/167/ 196		0 265 050 010 0 265 050 010 0 265 050 010	

		S							
EuroStar									
 									
	260 E 38	06.92-09.95	276				F 026	005 564	
	190 E 52 440 E 42 440 E 52	04.92-12.00	309/378		THE		0 265	150 308 ¹⁸	
	190 E 52 440 E 42 440 E 52	04.92-12.00	309/378				0 265	050 010	
EuroTech									
 									
	175 E 27	04.92-07.00	196				0 204	162 071	
	175 E 27 179 E 27 180 E 24, E 27, E 30, E 34 180 E 38, E 42, E 52 190 E 24, E 27, E 30, E 34, E 42 240 E 38, E 42 260 E 42, E 52 400 E 34, E 38, E 42, E 52 440 E 34	04.92-12.00	176/196/ 221/254/ 276/309/ 378		THE		0 265	150 308 ¹⁸	
	175 E 27 179 E 27 180 E 24, E 27, E 30, E 34 180 E 38, E 42, E 52 190 E 24, E 27, E 30, E 34, E 42 240 E 38, E 42 260 E 42, E 52 400 E 34, E 38, E 42, E 52 440 E 34	04.92-12.00	176/196/ 221/254/ 276/309/ 378				0 265	050 010	
EuroTrakker									
 									
	260 E 37	12.94-12.01	272				F 026	005 564	
	400 E 34 440 E 34	04.92-12.00	254		THE		0 265	150 308 ¹⁸	
	400 E 34 440 E 34	04.92-12.00	254				0 265	050 010	



Scudato



	35.10	01.99-12.03	76		F 026 003 140	25,4
	60.13	10.05→	92		0 204 123 413	

	35.10	01.99-12.03	76		0 204 125 266	
	60.13	10.05→	92		0 204 125 519	

TurboStar



	190-36, P	07.87-12.00	265/277/		0 204 162 077	
	240-36, -36, P, -48		350			
	260-36					

TurboTech



	190-24, -26, -32, -36, -36 T	09.86-01.01	177/192/		0 204 162 077	
	220-36		234/236/			
	240-32, -36 P		277			
	260-32, -36					

50



	-9	01.87-06.91	65		F 026 003 176	25,4
--	----	-------------	----	--	----------------------	------

	-9	01.87-06.91	65	TW	0 204 125 305	
--	----	-------------	----	----	----------------------	--

	-9	01.87-06.91	65		F 026 005 568	
--	----	-------------	----	--	----------------------	--



























60

























	-9 A	11.85-04.88	64	254	F 026 003 160	25,4
	-11	01.87-05.91	74		F 026 003 176	25,4

	-11	01.87-05.91	74		0 204 125 304	
--	-----	-------------	----	--	----------------------	--

	-11	01.87-05.91	74		F 026 005 075	
--	-----	-------------	----	--	----------------------	--

		S							
65									
 									
	-9	01.87-12.92	65				F 026 003 176	25,4	
					254		F 026 003 160	25,4	
	-12	01.87-12.92	85			TW	F 026 003 179	27	
							F 026 003 980	28,57	
	-9	01.87-12.92	65/85				F 026 005 075		
	-12								
	-9	01.87-12.92	65/85				F 026 005 568		
	-12								
75									
 									
	-9A...	11.85-05.89	64			254	F 026 003 160	25,4	
	-9A...	11.85-05.89	64			TW	0 204 125 290		
79									
 									
	-14	12.85-12.92	102			TW	F 026 003 980	28,57	
	-12	12.85-12.92	85/102				F 026 005 568		
	-14								
109									
 									
	-14	11.85-06.91	102			TW	F 026 003 179	27	
							F 026 003 980	28,57	
	-14	11.85-06.91	102				F 026 005 075		
	-14	11.85-06.91	102				F 026 005 568		



		S							
115									
									
	-14 -17	11.85-12.99	99-102/ 130				0 204 162 071		
	-14 -17	11.85-12.99	99-102/ 130				0 204 163 059		
135									
									
	-14 -17	11.85-08.92	102/130				0 204 162 071		
	-14 -17	11.85-08.92	102/130				0 204 163 059		
145									
									
	-17	02.86-07.92	130				0 204 162 071		
	-17	02.86-07.92	130				0 204 163 059		
175									
									
	-17 -24, P	09.86-07.92	130/177				0 204 162 071		
	-17	09.86-07.92	130				0 204 163 059		
315									
									
	.8.18	01.92-11.00	130			THE	0 265 150 302 ¹⁸		
	.8.18	01.92-11.00	130				0 265 050 010		



370



	S.12.L.25	01.87-11.98	177/191/		0 265 050 002
	S.12.30		220-224	ZUB	0 265 050 008
	S 24				

380



	.10.29	01.92-11.00	214		0 265 050 010
	.12.29				

480



	.10.21 Turbocity-U	04.89-11.98	155		0 265 150 301 ¹⁸
	.12.21 Turbocity-U				

	.10.21 Turbocity-U	04.89-11.98	155		0 265 050 010
	.12.21 Turbocity-U				

580



	.10.21 Turbocity-S	04.89-11.98	155		0 265 150 301 ¹⁸
	.12.21 Turbocity-S				

	.10.21 Turbocity-S	04.89-11.98	155		0 265 050 010
	.12.21 Turbocity-S				

680



	.12.26 Turbocity-I	06.89-11.98	191		0 265 150 301 ¹⁸

	.12.26 Turbocity-I	06.89-11.98	191		0 265 050 010

JEEP

Cherokee [XJ]



	4.0	09.93-12.01	127-131/ 135		1 987 481 083	→ 460





◀ JEEP Cherokee [XJ]



	2.5 i	08.93-03.00	90/127-131	09Z,BHO	0986 475 916	↔ 20,64
	4.0	08.93-08.01	90/127-131	10Z,BHO	0986 475 872	→ 22,19
					0986 475 873	← 22,19



	2.5 D Turbo	10.95-12.99	85-89		0986 480 958	25,4
		01.00-12.01	85-89		0986 480 958	25,4
	2.5 i	08.90-12.99	90		0986 480 958	25,4
		01.00-09.01	90		0986 480 958	25,4
	4.0	09.93-12.99	127-131		0986 480 958	25,4
		01.00-08.01	127-131		0986 480 958	25,4

Comanche [MJ]



	2.1 D Turbo	01.88-12.96	64/90/129		0986 475 872	← 22,19
	2.5				0986 475 873	→ 22,19
	4.0 i					









KÄSSBOHRER

Setra



	S 210 H..	09.85-06.01	177/184/	MMH	0332 204 202 ²³	
	S 211 H..		191/206/			
	S 214 H..		213/243/			
	S 215 H.., SL, UL		260/265/			
	S 216 HDS, HDS..		276			
	S 228 DT..					
	SG 219 SL					
	SG 221 UL					

	S 210 H..	08.90-06.96	159		0265 050 011	
	S 210 H..	09.85-07.90	184/191		0265 050 006	
	S 211 H..	09.85-06.96	184/191	SA	0265 050 004	
		08.90-06.96	184/191		0265 050 011	
	S 211 H..	08.90-06.96	206/243		0265 050 011	
	S 213 H, H.., HR.., RL					
	S 214 HD..					
	S 214 H..	09.86-07.90	243/265		0265 050 006	
		09.86-01.95	243/265	SA	0265 050 004	
		08.90-01.95	243/265		0265 050 011	
	S 215 H..	08.90-06.96	206/243		0265 050 011	
	S 215 H..	09.85-07.90	243/260/265/298		0265 050 006	
	S 215 HDH Intercontinental	09.85-06.96	243/260/265/298	SA	0265 050 004	
		08.90-06.96	243/260/265/298		0265 050 011	
	S 215 HR.., NR, RL	08.90-06.96	184/206		0265 050 011	
	S 215 SL, UL	09.85-07.90	177/206/213/265		0265 050 006	
		09.85-06.96	177/206/213/265	SA	0265 050 004	
		08.90-06.96	177/206/213/265		0265 050 011	
	S 216 HDS	09.86-07.90	177/206/213/265		0265 050 006	
		09.86-01.95	177/206/213/265	SA	0265 050 004	
		08.90-01.95	177/206/213/265		0265 050 011	
	S 216 HDS..	09.85-06.96	243/276		0265 050 002	
	S 228 DT..					

	S							
S 300 N	10.91→	177/213/				0 265 050 033		
S 309 HD		250/269/						
S 315 HD, HDH		280						
SG 219 SL	09.85-06.01	177/206				0 265 050 002		
					SA	0 265 050 006		
		213				0 265 050 004		
					SA	0 265 050 006		
SG 221 UL	09.85-06.01	177/206				0 265 050 002		
						0 265 050 006		
					SA	0 265 050 004		
		213/243				0 265 050 006		
					SA	0 265 050 004		

LDV GROUP LIMITED

Maxus



	2.5	01.05→	70-88			0 265 231 562 ¹⁶		
--	-----	--------	-------	--	--	-----------------------------	--	--

LIAZ (CZ)

Serie 100-300



	100 .55 p	01.91-09.03	257		WLC	0 332 204 201 ²³		
--	-----------	-------------	-----	--	-----	-----------------------------	--	--

	100 .55 p	01.91-09.03	257			0 265 050 014		
--	-----------	-------------	-----	--	--	---------------	--	--

MACK (TRUCKS)

Serie R



	R, RB, RD, RM	06.89→				0 265 150 301 ¹⁶		
--	---------------	--------	--	--	--	-----------------------------	--	--

	R, RB, RD, RM	06.89→				0 265 050 014		
--	---------------	--------	--	--	--	---------------	--	--





MAN

Bus



	LE 232 FOC	11.95→	162/206	TW	0 486 104 033 ¹⁸
	LE 282 FOC				
	8.220 FOCL				
	18.282 FOC				

	22.280 HOCLN	05.85-09.89	206/243/	MH	0 332 204 202 ²³
	22.330 HOCLN		265		
	22.360 HOCLN				









	22.280 HOCLN	05.85-09.89	206/243/		0 265 050 002
	22.330 HOCLN		265		
	22.360 HOCLN				

E2000



	19.293 FA	06.96-09.02	170/213/	TW	0 486 104 033 ¹⁸
	19.314 FALS/FALK		228/250/		
	19.343 FA		265/294/		
	19.364 FA		301/338/		
	19.403 FA		441		
	19.414 FA				
	19.463 FA				
	19.464 FALS/FALK				
	26.233 F				
	26.293 FL				
	26.314 FA				
	26.343 FL				
	26.364 FAV				
	26.403 FA, FL				
	26.414 FAVL				
	26.463 FA, FL				
	26.464 FA				
	27.604 DFAS				
	28.233 FNLC				
	28.293 FNL				
	28.314 FNLC				
	28.343 FNL				
	28.364				



		S							
28.403 FANL, FNL		09.96-09.02	170/213/			TW	0 486 104 033 ¹⁸		
28.414 , FNLC			228/250/						
28.463 FANL, FNL			265/294/						
28.464 , FL			301/338/						
30.293 FNL			441						
30.314 FNLC									
30.343 FNL									
30.364 FANLC, FNLC									
30.403 FANL, FNL									
30.414 FANLC, FNLC									
30.463 FANL, FNL									
30.464 FANLC, FNLC									
32.314 VFNLC									
32.364 VFNLC									
32.403 VFL									
32.414 VFLC									
32.463 VFL		06.96-01.02	170/213/			TW	0 486 104 033 ¹⁸		
32.464 VFNLC			228/250/						
33.293 DFL			265/294/						
33.343 DFL			301/338/						
33.364 , DFAL, DFL			441						
33.403 DFAL, DFL									
33.414 , DFAL, DFL									
33.463 DFAL, DFL									
33.464 , DFAL, DFL									
33.604 DFAS, DFAS, DFALS									
35.343 VF, VFA									
35.364 VF, VFA									
35.403 FV, VF									
35.414 FV, VF, VFA		06.96-12.01	170/213/			TW	0 486 104 033 ¹⁸		
35.463 FV, VF, VFA			228/250/						
35.464 FV, VF, VFA			265/294/						
40.604 DFAS			301/338/						
41.343 VF, VFA			441						
41.364 VF, VFA									
41.403 VF, VFA									
41.414 VF, VFA									
41.463 DFVL, VF, VFA									
41.464 DFVL, VF, VFA									
41.604 DFVLS									
42.414 VFAK		06.98-09.01	170/213/			TW	0 486 104 033 ¹⁸		
42.464 VFAK			228/250/						
50.414 VF, VFA			265/294/						
50.464 VF, VFA			301/338/						
50.604 VFAS			441						





◀ MAN E2000









	19.403 FA, FL	06.96-12.01	228/250/		0 265 050 108
	19.463 FA, FL		265/294/		0 265 050 108 ⁴
	28.403 FNL		301/338		
	28.463 FNL				
	30.314 FNLC				
	30.364 FNLC				
	30.403 FNL				
	30.414 FNLC				
	30.463 FNL				
	30.464 FNLC				
	33.364, DFL				
	33.403 DFL				
	33.414, DFL				
	33.463 DFL				
	33.464, DFL				
	35.343 VF, VFA				
	35.364 VF, VFA				
	35.403 VF				
	35.414 VF, VFA	06.96-12.01	228/250/		0 265 050 108
	35.463 VF, VFA		265/294/		0 265 050 108 ⁴
	35.464 VF, VFA		301/338		
	41.343 VF, VFA				
	41.364 VF, VFA				
	41.403 VF, VFA				
	41.414 VF, VFA				
	41.463 VF, VFA				
	41.464 VF, VFA				
	42.414 VFAK				
	42.464 VFAK				
	50.414 VF, VFA				
	50.464 VF, VFA				



E2000 Evol. (FE)





	19.310 F, FA	09.01-12.03	228/265/	TW	0 486 104 033 ¹⁸
	19.360 F, FA		301/338		
	19.410 F, FA				
	19.460 F, FA				
	26.360 DF				
	26.410 DF				
	26.460 DF				
	28.310 DF				
	28.360 DA, DF				
	28.410 DA, DF				
	28.460 DA, DF				
	30.360 DF				
	30.410 DF				
	30.460 DF				
	32.360 VF				
	32.410 VF				
	32.460 VF				
	33.360 DA, DF				
	33.410 DA, DF				
	33.460 DA				

	S							
33.460 DF 35.360 VA, VF 35.410 VA, VF 35.460 VA, VF 41.410 VA, VF 41.460 VA, VF 50.410 FVN, VA, VF 50.460 FVN, VA, VF 310A DF, F, FA, VF 360A DA, DF, F, FA, VA, VF	01.00-10.03	228/265/ 301/338			TW	0 486 104 033 ¹⁸		
410A DA, DF, F, FA, FVA, FVF, VA, VF 460A DA, DF, F, FA, FVN, VA, VF	01.00-09.02	228/265/ 301/338			TW	0 486 104 033 ¹⁸		

F/M/U 90



 33.242 DF 33.262 DF 33.292 DF 33.332 DF 33.362 DF	09.87-02.88	177/191/ 213/243/ 265			TW	0 265 150 101 ¹⁶		
--	-------------	-----------------------------	--	--	----	-----------------------------	--	--

 19.242 F, FL 19.262 F, FA, FL 19.292 F, FA, FL 19.332 F, FA, FL, U, UL 19.362 F, FA, FL, U, UL 19.462 F, FLS 22.292 FNL 22.332 FNL, UNL 22.362 FNL, UNL	07.86-01.91	177/191/ 213/243/ 265/338			MIH	0 332 204 202 ²³		
---	-------------	---------------------------------	--	--	-----	-----------------------------	--	--

24.242 DF, FNL, FVL 24.262 DF, FNL, FVL 24.292 DF, FNL, FVL 24.332 DF, FNL, FVL, UNL 24.362 DF, FNL, FVL, UNL 24.462 FVLS 26.242 DF, DFA 26.262 DF, DFA 26.292 DF, DFA 26.332 DF	10.86-02.90	177/191/ 213/243/ 265/338			MIH	0 332 204 202 ²³		
---	-------------	---------------------------------	--	--	-----	-----------------------------	--	--

26.332 DFA 26.362 DF, DFA 26.462 DF, DFA 32.262 VF 32.292 VF 32.332 VF 32.362 VF 33.242 DF 33.262 DF 33.292 DF, DFA 33.332 DF, DFA 33.362 DF, DFA 35.262 VF, VFA 35.292 VF, VFA 35.332 VF, VFA 35.362 VF, VFA	09.87-04.95	177/191/ 213/243/ 265/338			MIH	0 332 204 202 ²³		
--	-------------	---------------------------------	--	--	-----	-----------------------------	--	--





◀ MAN F/M/U 90

	19.242 F, FL	07.86-01.91	177/191/		0 265 050 002
	19.262 F, FA, FL		213/243/		
	19.292 F, FA, FL		265/338		
	19.332 F, FA, FL, U, UL				
	19.362 F, FA, FL, U, UL				
	19.462 F, FLS				
	22.292 FNL				
	22.332 FNL, UNL				
	22.362 FNL, UNL				
	24.242 DF, FNL, FVL	10.86-02.90	177/191/		0 265 050 002
24.262 DF, FNL, FVL		213/243/			
24.292 DF, FNL, FVL		265/338			
24.332 DF, FNL, FVL, UNL					
24.362 DF, FNL, FVL, UNL					
24.462 FVLS					
26.242 DF, DFA					
26.262 DF, DFA					
26.292 DF, DFA					
26.332 DF					
26.332 DFA	09.87-04.95	177/191/		0 265 050 002	
26.362 DF, DFA		213/243/			
26.462 DF, DFA		265/338			
32.262 VF					
32.292 VF					
32.332 VF					
32.362 VF					
33.242 DF					
33.262 DF					
33.292 DF, DFA					
33.332 DF, DFA					
33.362 DF, DFA					
35.262 VF, VFA					
35.292 VF, VFA					
35.332 VF, VFA					
35.362 VF, VFA					



FR-FRH











	292	05.85-03.91	213		0 265 150 101 ¹⁶
	352	09.95-11.99	257	TW	0 486 104 033 ¹⁸
	362	05.85-12.92	265		0 265 150 101 ¹⁶
	402	09.95-11.99	294	TW	0 486 104 033 ¹⁸

	292	01.88-12.92	213/265		0 265 050 002
	362				

F2000



	19.233 F	08.96-12.01	170/213	TW	0 486 104 033 ¹⁸
	19.293 F, FA, FL				
	19.314 F, FAS/FAC/FAK	06.98-12.01	228	TW	0 486 104 033 ¹⁸
	19.314 FLL	06.98-12.01	228		0 486 104 033 ¹⁸
	19.314 FLLS/FLLC/FLCW	06.98-09.01	228	TW	0 486 104 033 ¹⁸
	19.314 FLS/FLK/FLC				
	19.343 F, FA, FL	08.96-01.00	250	TW	0 486 104 033 ¹⁸
	19.364 F, FA, FL	06.98-12.01	265	TW	0 486 104 033 ¹⁸

		S							
19.364 FLL		06.98-09.01	265				TW	0 486 104 033 ¹⁸	
		06.98-12.01	265					0 486 104 033 ¹⁸	
19.373 FL		01.94-12.95	272				TW	0 486 104 033 ¹⁸	
19.403 F, FA		08.96-12.01	294				TW	0 486 104 033 ¹⁸	
19.403 FL		08.96-12.01	294					0 486 104 033 ¹⁸	
19.403 FL		01.94-12.01	294/301				TW	0 486 104 033 ¹⁸	
19.414 F, FA, FL									
19.414 FLL		06.98-12.01	294/301					0 486 104 033 ¹⁸	
							TW	0 486 104 033 ¹⁸	
19.423 FL		01.94-12.95	309				TW	0 486 104 033 ¹⁸	
19.463 F, FA		01.94-12.01	338				TW	0 486 104 033 ¹⁸	
19.463 FL		01.94-09.01	338				TW	0 486 104 033 ¹⁸	
		08.96-12.01	338					0 486 104 033 ¹⁸	
19.464 F, FA, FL, FLL		06.98-12.02	338				TW	0 486 104 033 ¹⁸	
19.464 FLL-P, FLLR-P		06.98-12.01	338					0 486 104 033 ¹⁸	
19.603 FL		08.96-12.02	213/228/				TW	0 486 104 033 ¹⁸	
19.604 FLS			250/265/						
23.293			294/301/						
23.314 FNLC, FNLLC, FNLLC/L			441						
23.343									
23.364 FNLC, FNLLC, FNLLC/L									
23.403 FNL									
23.414 FNLC, FNLLC, FNLLC/L									
23.463 FNL		01.94-12.02	338				TW	0 486 104 033 ¹⁸	
23.464 FNLC, FNLLC, FNLLC/L									
24.293 FNL		08.96-08.02	213/228/				TW	0 486 104 033 ¹⁸	
24.314 FNLLRC			250/265/						
24.343 FNL			294/301						
24.364 FNLLRC									
24.403 FNL									
24.414 FNLLRC									
24.463 FNL		01.94-08.02	170/338				TW	0 486 104 033 ¹⁸	
24.464 FNLLRC									
26.233 FVL									
26.293 DF, DFL, FNL, FVL		08.96-06.02	213/228/				TW	0 486 104 033 ¹⁸	
26.314 DFL, DFS/DFK/DF-TM/DFC			250/265/						
26.314 FNL, FNLLC/FNLLW			294/301						
26.314 FNLS/FNLC, FVL									
26.343 DF, DFL, FNL, FVL									
26.364 DF, DFL, FNL, FNLL, FVL									
26.403 DF, DFL, FNL, FVL									
26.414 DFL, DFS/DFK/DF-TM/DFC									
26.414 FNL, FNLLC/FNLLW, FVL		07.99-06.02	213/228/250/265/294/301				TW	0 486 104 033 ¹⁸	
26.463 DF, DFL, FNL, FVL		01.94-06.02	338				TW	0 486 104 033 ¹⁸	
26.464 DF, DFL, FNL, FNLL, FVL									
26.603 DFL		08.96-09.01	213/228/				TW	0 486 104 033 ¹⁸	
26.604 DFSL			250/265/						
27.293 DF, DFA			441						
27.314 DF, DFA									
27.343 DF, DFA									
27.364 DF, DFA									
27.373 DFA		01.94-09.01	272/294				TW	0 486 104 033 ¹⁸	
27.403 DFA									
27.403 DFC		08.96-12.01	294/301				TW	0 486 104 033 ¹⁸	
27.414 DF, DFA									
27.423 DFA		01.94-09.01	309/338				TW	0 486 104 033 ¹⁸	
27.463 DF, DFA									
27.464 DF, DFA									





	MAN F2000						
	27.603 DF, DFA	08.96-01.02	213/228/		TW	0 486 104 033 ¹⁸	
	27.604 DFS		250/265/				
	32.293 VF		294/301/				
	32.314 VF-TM		441				
	32.343 VF						
	32.364 VF						
	32.403 VF						
	32.414 VF						
	32.463 VF	08.95-09.01	338		TW	0 486 104 033 ¹⁸	
	32.464 VF						
	33.343 DF, DFA	08.96-09.01	250/265		TW	0 486 104 033 ¹⁸	
	33.364 DF, DFA						
	33.373, DFA	01.94->	272		TW	0 486 104 033 ¹⁸	
	33.374 K/L						
	33.403 DF	08.96-09.01	294		TW	0 486 104 033 ¹⁸	
	33.403 DFA	01.94-12.01	294/301/		TW	0 486 104 033 ¹⁸	
	33.414 DF		309/338				
	33.423 DFA						
	33.463 DF, DFA						
	33.464 DF						
	33.603 DF, DFA	08.96-01.02	250/265/		TW	0 486 104 033 ¹⁸	
	33.604 DFS		294/301/				
	35.343 VF		441				
	35.364 VF						
	35.403 VF						
	35.414 VF						
	35.463 VF	08.95-12.01	301/338		TW	0 486 104 033 ¹⁸	
	35.464 VF						
	40.414 DFA, DFK						
	40.464 DFA, DFK						
	41.343 VF	08.96-09.01	250/265/		TW	0 486 104 033 ¹⁸	
	41.364 VF		294/301				
	41.403 VF						
	41.414 VF						
	41.463 VF	08.95-09.01	338		TW	0 486 104 033 ¹⁸	
	41.464 VF						

	26.373 FNL	01.94-09.01	272/294/			0 265 050 108	
	26.403 FNL		309/338				
	26.423 FNL						
	26.463 FNL						

F2000 Evol. (FE)

	26.310 DF	09.02-09.03	228/265/		TW	0 486 104 033 ¹⁸	
	26.360 DF		301				
	35.310 VF						
	35.410 VF						
	310A DA, DF, F, FA	01.00-08.02	228/265		TW	0 486 104 033 ¹⁸	
	310A F, FL	01.00-12.01	228/265			0 486 104 033 ¹⁸	
	310A VF	07.99-09.02	228/265		TW	0 486 104 033 ¹⁸	
	360A DA, DF, F, FA						
	360A F, FL	01.00-12.01	228/265			0 486 104 033 ¹⁸	
	360A VF	01.00-08.02	228/265		TW	0 486 104 033 ¹⁸	
	410A DA, DF, F, FA, VF	07.99-09.02	301/338		TW	0 486 104 033 ¹⁸	
	460A DA, DF, F, FA, VF						



LionsCity'



CPU	G, GL	07.98→	162/176/	TW	0 486 104 033 ¹⁸
	NG 243, 263, 313, 353, 363		177/180/		
	NL 313		191/206/		
	NÜ 243, 263, 313		228/257/		
	T, TÜ		258/265		
Ü					

LionsClassic'



CPU	SL 223	06.03-10.06	162/206		0 486 104 033 ¹⁸
	SL 283				

LionsComfort'



CPU	R 313	01.98-12.01	228/257	TW	0 486 104 033 ¹⁸
	ÜL 313				
	ÜL 353				

LionsStar'



CPU	RH 352	07.98-09.01	257/294/	TW	0 486 104 033 ¹⁸
	RH 402		338		
	RH 463				

LionsTopCoach'



CPU	RH 403	06.99-01.04	294/339	TW	0 486 104 033 ¹⁸
	RH 463				

L2000



CPU	8.103 F, FL, L, LL	10.93-08.02	75/81/83/	TW	0 486 104 033 ¹⁸
	8.113 L, LL		103/104/		
	8.153 F, FL, L, LA, LL		114/118/		
	8.163 F, FL, L, LA, LL		132/162/		
	8.185 L, LL		191		
	8.223 F, FL, L, LA, LL				
	8.224 F, FL				
	8.224 L, LA, LC, LK, L-KI, LK-LV, LL	10.93-08.02	75/81/83/	TW	
	8.224 LLC, LLS		103/104/		
	9.153 F, FL, L, LL		114/118/		
9.163 F, FL, L, LL		132/162/			
9.185 L		191			
9.223 F, FL, L, LL					
9.224 F, FL, L					





	MAN L2000					
	9.224 LC, LK, L-KI, LK-LV, LL, LLC, LLS	10.93→	75/81/83/		TW	0 486 104 033 ¹⁸
	10.145 L		103/104/			
	10.153 F, FL, L, LA, LL		114/118/			
	10.160 LA		132/162/			
	10.163 F, FL, L, LA, LL		191			
	10.220 FOCL					
	10.223 F, FL, L, LA					
	10.224 F, FL, L, LA, LC, LK, LK-L	05.94→	75/81/83/		TW	0 486 104 033 ¹⁸
	12.163 L, LL		103/104/			
	12.224 L, LL		114/118/			
	14.163 L, LL		132/162/			
	14.224 L, LA, LL		191			
	14.264 L, LA, LL					
	15.163 L, LL					
	15.224 L, LL					
	15.264 L, LL					
	18.224 L					
	18.224 LA, LL	08.95-09.01	75/81/83/		TW	0 486 104 033 ¹⁸
	18.264 L, LA, LL		103/104/			
	20.224 L, LL		114/118/			
	20.264 L, LL		132/162/191			

	8.223 F, L	05.94-09.01	162/191			0 265 050 108 ⁴
	8.224 F, L, LC, LK, L-KI, LK-LV					
	9.223 F, L					
	9.224 F, L, LC, LK, L-KI, LK-LV					
	14.224 L, LL					
	14.264 L, LL					











L2000 Evol. (LE)

	8.140 F, FL	09.00-12.06	103/114/		TW	0 486 104 033 ¹⁸
	8.180 F, FL		132/162			
	8.220 F, FL					
	9.140 F, FL					
	9.180 F, FL					
	9.220 F, FL					
	10.180 F, FA, FL					
	10.220 F, FA, FL					
	140C F, FL					
	160B F, FL					
	160C F, FL					
	180C F, FA, FL					
	220C F, FA, FL					

M2000

	12.163 L	08.96-08.02	114/162/		TW	0 486 104 033 ¹⁸
	12.224 M, ML		180/191/			
	12.255 MC, MLS		206			
	12.264 M, ML					
	12.284 MC, MLC, MLS					
	12.285 MC					
	14.224 M, MA, ML					
	14.264 M, MA, ML					
	14.284 LA-AF, LAC, LAK, LC, LRC					
	14.284 LK, LRK, LLC, LLLC, MAK					

	S							
14.284 MA-KO, MA-LF, MC, MLC	06.98-09.01	114/162/			TW	0 486 104 033 ¹⁸		
14.284 MLLC, MLS		180/191/						
15.284 LC, LK-LV, LLC, LLLC		206						
18.224 M	08.95-09.01	162			TW	0 486 104 033 ¹⁸		
18.224 MA	08.96-09.01	162			TW	0 486 104 033 ¹⁸		
18.224 ML, MLLC	08.95→	162/191			TW	0 486 104 033 ¹⁸		
18.232 FOC/HOC								
18.264 M	08.95-09.01	162/191			TW	0 486 104 033 ¹⁸		
18.264 MA	08.96-09.01	191			TW	0 486 104 033 ¹⁸		
18.264 ML	08.95-09.01	119/162/180/191/206			TW	0 486 104 033 ¹⁸		
18.282 FOC	08.95→	119/162/			TW	0 486 104 033 ¹⁸		
18.284 LAC, LAK-LV, LC, LK-LV		180/191/						
18.284 L-KO, LLC, LLK, LLLC		206						
18.284 LS, TSL, MAC, MAK, MAK-LV								
18.284 MC, MK-LV, M-KO, MLLC								
18.292 FOC								
20.284 LNLC, LNLLC								
25.224 M, ML, MVL								
25.264 M, ML								
25.264 MVL	06.96→	119/162/			TW	0 486 104 033 ¹⁸		
25.284 LNLS, MNLC, MNLLC, MVLC		180/191/						
26.225 DLK		206						
26.255 DLK								
26.284 DL, L, AK								
26.285 DLK, DL-TM								



14.284 LC, LRC, LK, LRK, LLC, LLLC 10.98-09.01 206 0 265 **050 108**⁴



M

M2000 Evol. (LE)



12.180 F, FL	09.02-09.06	114/132/			TW	0 486 104 033 ¹⁸		
12.220 F, FL		162/180/						
12.250 F, FL		206						
12.280 F, FL								
14.220 F, FL								
14.225 F, FA								
14.250 F, FL								
14.255 F, FA								
14.280 F, FL								
14.285 F, FA								
15.180 F, FL								
15.220 F, FL								
15.250 F, FL								
15.280 F, FL								
18.220 F, FA, FL								
18.250B F, FA, FL								
18.280 F, FA, FL								
20.220 DF								
20.250 DF								
20.280 DF								
160B F, FA, FL	08.00-09.02	114/132/			TW	0 486 104 033 ¹⁸		
180B F, FL		162/180/						
180C F, FL		206						
220B DF, F, FA, FL								
220C F, FL								
250B DF, F, FA, FL								
280B DF, F, FA, FL								



M2000 Evol. (ME)



	12.220 F, FL	08.00-07.05	162/180/	TW	0 486 104 033 ¹⁸
	12.250 F, FL		206		
	12.280 F, FL				
	14.220 F, FA, FL				
	14.250 F, FA, FL				
	14.280 F, FA, FL				
	18.220 F, FA, FL				
	18.250 F, FA, FL				
	18.280 F, FA, FL				
	25.250 DF				
	25.280 DF				
	220B DF, F, FA, FL				
	250B DF, F, FA, FL				
	280B DF, F, FA				
280B F, FL	09.00-08.02	162/180/206	TW	0 486 104 033 ¹⁸	

NL



	223 F	02.96-12.01	162/170/	TW	0 486 104 033 ¹⁸
	233		191/228		
	263, F				
	313, F				



NÜ



	233	09.96→	170/191/	TW	0 486 104 033 ¹⁸
	263		228		
	313				

R



	292	03.86-04.92	213-224		0 265 050 002
--	-----	-------------	---------	--	---------------

RH































	352	07.98-09.01	257/294	TW	0 486 104 033 ¹⁸
	402				























RÜ





























	240	01.86-12.88	177/206		0 265 050 002
	280				

		S							
SD									
	 								
	202 F	01.87-04.91	150-157				0 265 050 002		
SG									
	 								
	242	08.88-03.90	177-180/ 213-224				0 265 153 101 ¹⁶		
	240 H 242, F, H	09.85-04.94	177-180/ 213-224				0 265 050 002		
SL									
	 								
	223 F 283 F	06.04-09.06	162/206				0 486 104 033 ¹⁸		
SL II									
	 								
	202 F	09.89-04.91	150-157				0 265 050 002		
sÜ									
	 								
	223 F 283 F 313 F 363 F 383 F	06.04-09.06	162/206/ 228/265				0 486 104 033 ¹⁸		
	242	01.87-04.93	177-180				0 265 050 002		
ÜL									
	 								
	313 353	09.96-12.01	228/257		TW		0 486 104 033 ¹⁸		



		S							
12t									
									
	12.152 F, FL 12.192 F, FL 12.232 F, FL	08.88-10.92	110-114/ 137/169				0 265 150 301 ¹⁸		
	12.152 F, FL 12.192 F, FL 12.232 F, FL	08.88-10.92	110-114/ 137/169		MIH		0 332 204 202 ²³		
	12.152 F, FL 12.192 F, FL 12.232 F, FL	08.88-10.92	110-114/ 137/169				0 265 050 002		
14t									
									
	14.152 F, FL 14.192 F, FL 14.232 F, FL	08.88-10.92	110-114/ 137/169				0 265 150 301 ¹⁸		
	14.152 F, FL 14.192 F, FL 14.232 F, FL	08.88-10.92	110-114/ 137/169		MIH		0 332 204 202 ²³		
	14.152 F, FL 14.192 F, FL 14.232 F, FL	08.88-10.92	110-114/ 137/169				0 265 050 002		
17t									
									
	17.192 F, FA, FL 17.232 F, FA, FL	08.88-05.95	137/169			TW	0 265 150 301 ¹⁸		
	17.192 F, FA, FL 17.232 F, FA, FL	08.88-05.95	137/169			MIH	0 332 204 202 ²³		
	17.192 F, FA, FL 17.192 GM2 17.232 F, FA, FL 17.232 GM2	08.88-06.90 10.92-05.94 08.88-05.95 03.91-05.94	137 140 169 169				0 265 050 002 0 265 050 108 ⁴ 0 265 050 002 0 265 050 108 ⁴		
19t									
									
	19.291 F, FA, FL 19.331 F, FA, FL, U, UL	09.85-07.89	213/243			MIH	0 332 204 202 ²³		
	19.291 F, FA, FL 19.331 F, FA, FL, U, UL	09.85-07.89	213/243				0 265 050 002		



		S							
20t									
	 								
	20.291 FVLS 20.331 FVLS	09.85-11.86	213/243			MIH	0 332 204 202 ²³		
	20.291 FVLS 20.331 FVLS	09.85-11.86	213/243				0 265 050 002		
22t									
	 								
	22.291 FNL 22.331 FNL 22.331 UNL, UNLW	09.85-11.86	213/243			MIH	0 332 204 202 ²³		
	22.291 FNL 22.331 FNL 22.331 UNL, UNLW	09.85-11.86	213/243				0 265 050 002		
24t									
	 								
	24.291 FNL, FVL 24.331 FNL, FVL, UNL 24.361 FNL, FVLS, UNL	11.86-07.89	213/243/ 265			MIH	0 332 204 202 ²³		
	24.291 FNL, FVL 24.331 FNL, FVL, UNL 24.361 FNL, FVLS, UNL	11.86-07.89	213/243/ 265				0 265 050 002		
26t									
	 								
	26.291 DF, DFLS 26.331 DF 26.331 DFLS	09.85-02.89	213/243			MIH	0 332 204 202 ²³		
	26.291 DF, DFLS 26.331 DF 26.331 DFLS	09.85-02.89	213/243				0 265 050 002		
MAZDA									
Serie E									
	 								
	2.0, i, 4WD 2.2 D, D 4WD	07.85-04.97	44-47/ 60-65/70				0 986 480 673	22,19	





MERCEDES-BENZ

Actros II [MP2]



	1832, BlueTec	04.03→	235/265/	Komp.Nr. 533564/02	TNK	0 486 000 035 ³
	1836, BlueTec		300/320/			
	1841, BlueTec		335/350/			
	1844, BlueTec		370/375/			
	1846, BlueTec		395/405/			
	1848 BlueTec		425/440/			
	1850		450			
	1851 BlueTec					
	1854					
	1855 BlueTec					
	1858					
	1860 BlueTec					
	1861 Black Edition					
	2032					
	2036					
	2041					
	2044					
	2046					
	2048 Blue Tec					
	2050					
	2051 Blue Tec	04.03→	235/265/	Komp.Nr. 533564/02	TNK	0 486 000 035 ³
	2054		300/320/			
	2532, BlueTec		335/350/			
	2536, BlueTec		370/375/			
	2541, BlueTec		395/405/			
	2544, BlueTec		425/440/			
	2546, BlueTec		450			
	2548 BlueTec					
	2550					
	2551 BlueTec					
	2554					
	2555 BlueTec					
	2558					
	2560 BlueTec					
	2632					
	2636					
	2641					
	2644					
	2646					
	2648 Blue Tec					



		S							
2650		04.03→	235/265/	Komp.Nr. 533564/02	TNK		0 486 000 035 ³		
2654			300/320/						
2655	Blue Tec		335/350/						
2658			370/375/						
3232			395/405/						
3236			425/440/						
3241			450						
3332,	BlueTec								
3336									
3341									
3344									
3346									
3348	BlueTec								
3350									
3351	BlueTec								
3354									
3355	BlueTec								
3358									
4141									
4144									
4146									
4150									

Actros [SKN]

	1831,	AK, L	09.96-09.03	230/260/	LAB		0 486 000 001 ³		
	1835,	AK, L		290/315/	LAB,SBR		0 486 001 001 ⁴		
	1840,	AK, L		350/390/	RAB		0 486 000 002 ³		
	1843,	AK, L		420	RAB,SBR		0 486 001 002 ⁴		
	1848,	AK, L							
	1853,	L							
	1857,	L							
	2031,	A							
	2035								
	2040,	A							
	2043	AS							
	2053								
	2531	L	09.96-09.03	230/260/	LAB		0 486 000 001 ³		
	2535	L		290/315/	LAB,SBR		0 486 001 001 ⁴		
	2540	L		350/390/	RAB		0 486 000 002 ³		
	2543	L		420	RAB,SBR		0 486 001 002 ⁴		
	2548,	L							
	2553	L							
	2557	L							
	2631,	L							
	2635,	L							
	2640,	L							
	2643,	L							
	2648,	L							
	2653,	L							
	2657,	L							
	3231								
	3235								
	3240								





	◀ MERCEDES-BENZ Actros [SKN]					
3243	09.96-09.03	230/260/	LAB	0 486 000 001 ³		
3331, A		290/315/	LAB,SBR	0 486 001 001 ⁴		
3335		350/390/	RAB	0 486 000 002 ³		
3340, A		420	RAB,SBR	0 486 001 002 ⁴		
3343, A						
3348, A						
3353						
3357						
4140, A						
4143, A						
4148						

Atego II



	713 BlueTec	02.06→	95/115/		0 486 001 024 ⁴	
	716 BlueTec		130			
	813 BlueTec					
	816 BlueTec					
	818 BlueTec					
	822	09.04→	160	Komp.Nr. 509228/01, Komp.Nr. 509228/02, Komp.Nr. 509228/03, Komp.Nr. 509476/01, Komp.Nr. 509476/02, Komp.Nr. 591010/10	TNK	0 486 001 024 ⁴
	822 BlueTec					
	824 BlueTec	02.06→	115/130/		0 486 001 024 ⁴	
	916 BlueTec		175			
	918 BlueTec					
	922	09.04→	160	Komp.Nr. 509228/01, Komp.Nr. 509228/02, Komp.Nr. 509228/03, Komp.Nr. 509476/01, Komp.Nr. 509476/02, Komp.Nr. 591010/10	TNK	0 486 001 024 ⁴
	922 BlueTec					
	924 BlueTec	02.06→	115/130/		0 486 001 024 ⁴	
	1016 BlueTec		175			
	1018 BlueTec					
	1022	09.04→	160	Komp.Nr. 509228/01, Komp.Nr. 509228/02, Komp.Nr. 509228/03, Komp.Nr. 509476/01, Komp.Nr. 509476/02, Komp.Nr. 591010/10	TNK	0 486 001 024 ⁴
	1022 BlueTec					
	1024 BlueTec	02.06→	115/130/		0 486 001 024 ⁴	
	1216 BlueTec		175			
	1218 BlueTec					
	1222	09.04→	160	Komp.Nr. 509228/01, Komp.Nr. 509228/02, Komp.Nr. 509228/03, Komp.Nr. 509476/01, Komp.Nr. 509476/02, Komp.Nr. 591010/10	TNK	0 486 001 024 ⁴
	1222 BlueTec					
	1224 BlueTec	02.06→	130/175/		0 486 001 024 ⁴	
	1226 BlueTec		188/210			
	1229					
	1318 BlueTec					



	S							
1322 1322 BlueTec	09.04→	160	Komp.Nr. 509228/01, Komp.Nr. 509228/02, Komp.Nr. 509228/03, Komp.Nr. 509476/01, Komp.Nr. 509476/02, Komp.Nr. 591010/10	TNK	0 486 001 024 ⁴			
1324 BlueTec 1326 Blue Tec 1329 1518 BlueTec	02.06→	130/175/ 188/210			0 486 001 024 ⁴			
1522 1522 BlueTec	09.04→	160	Komp.Nr. 509228/01, Komp.Nr. 509228/02, Komp.Nr. 509228/03, Komp.Nr. 509476/01, Komp.Nr. 509476/02, Komp.Nr. 591010/10	TNK	0 486 001 024 ⁴			
1524 BlueTec 1526 Blue Tec 1529	02.06→	175/188/ 210			0 486 001 024 ⁴			

Atego [LKN]











	715 , L 815 , F, L 817 F 823 , L 923 , L 1023 , L 1215 , L 1223 , L 1225 AF, F 1323 , L, LKO 1325 AF, F 1523 , A 1523 AK, KO, L 1525 AF	01.98-09.04	112/170/ 180	Komp.Nr. 509223/01	TNK	0 486 104 001 ¹⁶		
		01.98-09.04	112/170/ 180	Komp.Nr. 509223/01	TNK	0 486 104 001 ¹⁶		

	712	01.98-09.04	90	Komp.Nr. 509228/01, Komp.Nr. 509228/02, Komp.Nr. 509228/03, Komp.Nr. 509476/01, Komp.Nr. 509476/02, Komp.Nr. 591010/10	TNK	0 486 001 024 ⁴		
		09.00→	90			0 486 001 024 ⁴		
	714 714 L	01.98-09.04	100	Komp.Nr. 509228/01, Komp.Nr. 509228/02, Komp.Nr. 509228/03, Komp.Nr. 509476/01, Komp.Nr. 509476/02, Komp.Nr. 591010/10	TNK	0 486 001 024 ⁴		
	715 715 715 L	09.00→ 01.98-09.04	110 112	Komp.Nr. 509228/01, Komp.Nr. 509228/02, Komp.Nr. 509228/03, Komp.Nr. 509476/01, Komp.Nr. 509476/02, Komp.Nr. 591010/10	TNK	0 486 001 024 ⁴ 0 486 001 024 ⁴		



		S							
◀ MERCEDES-BENZ Atego [LKN]									
717		01.98-09.04	125	Komp.Nr. 509228/01, Komp.Nr. 509228/02, Komp.Nr. 509228/03, Komp.Nr. 509476/01, Komp.Nr. 509476/02, Komp.Nr. 591010/10	TNK		0 486 001 024 ⁴		
		09.00-09.04	125				0 486 001 024 ⁴		
717 L		01.98-09.04	125	Komp.Nr. 509228/01, Komp.Nr. 509228/02, Komp.Nr. 509228/03, Komp.Nr. 509476/01, Komp.Nr. 509476/02, Komp.Nr. 591010/10	TNK		0 486 001 024 ⁴		
812 814 814 L		01.98→	90/100	Komp.Nr. 509228/01, Komp.Nr. 509228/02, Komp.Nr. 509228/03, Komp.Nr. 509476/01, Komp.Nr. 509476/02, Komp.Nr. 591010/10	TNK		0 486 001 024 ⁴		
815		09.00→	110				0 486 001 024 ⁴		
815 815 F 815 L 817 817 F 817 L		01.98-09.04	112/125	Komp.Nr. 509228/01, Komp.Nr. 509228/02, Komp.Nr. 509228/03, Komp.Nr. 509476/01, Komp.Nr. 509476/02, Komp.Nr. 591010/10	TNK		0 486 001 024 ⁴		
818		09.00→	130				0 486 001 024 ⁴		
823		01.98-09.04	170	Komp.Nr. 509228/01, Komp.Nr. 509228/02, Komp.Nr. 509228/03, Komp.Nr. 509476/01, Komp.Nr. 509476/02, Komp.Nr. 591010/10	TNK		0 486 001 024 ⁴		
		09.00-09.04	170				0 486 001 024 ⁴		
823 L		01.98-09.04	170	Komp.Nr. 509228/01, Komp.Nr. 509228/02, Komp.Nr. 509228/03, Komp.Nr. 509476/01, Komp.Nr. 509476/02, Komp.Nr. 591010/10	TNK		0 486 001 024 ⁴		
915		09.00→	110				0 486 001 024 ⁴		
915 AF 917 917 KO 917 L		01.98-09.04	125	Komp.Nr. 509228/01, Komp.Nr. 509228/02, Komp.Nr. 509228/03, Komp.Nr. 509476/01, Komp.Nr. 509476/02, Komp.Nr. 591010/10	TNK		0 486 001 024 ⁴		
918		09.00→	130				0 486 001 024 ⁴		
923		01.98-09.04	170	Komp.Nr. 509228/01, Komp.Nr. 509228/02, Komp.Nr. 509228/03, Komp.Nr. 509476/01, Komp.Nr. 509476/02, Komp.Nr. 591010/10	TNK		0 486 001 024 ⁴		
		09.00-09.04	170				0 486 001 024 ⁴		
923 L		01.98-09.04	170	Komp.Nr. 509228/01, Komp.Nr. 509228/02, Komp.Nr. 509228/03, Komp.Nr. 509476/01, Komp.Nr. 509476/02, Komp.Nr. 591010/10	TNK		0 486 001 024 ⁴		



		S							
925 AF		01.98-09.04	205	Komp.Nr. 509228/01, Komp.Nr. 509228/02, Komp.Nr. 509228/03, Komp.Nr. 509476/01, Komp.Nr. 509476/02, Komp.Nr. 591010/10	TNK		0 486 001 024 ⁴		
1015		09.00→	110				0 486 001 024 ⁴		
1017 1017 A 1017 AK 1017 KO 1017 L		01.98-09.04	125	Komp.Nr. 509228/01, Komp.Nr. 509228/02, Komp.Nr. 509228/03, Komp.Nr. 509476/01, Komp.Nr. 509476/02, Komp.Nr. 591010/10	TNK		0 486 001 024 ⁴		
1018		09.00→	130				0 486 001 024 ⁴		
1023		01.98-09.04	170	Komp.Nr. 509228/01, Komp.Nr. 509228/02, Komp.Nr. 509228/03, Komp.Nr. 509476/01, Komp.Nr. 509476/02, Komp.Nr. 591010/10	TNK		0 486 001 024 ⁴		
		09.00-09.04	170				0 486 001 024 ⁴		
1023 L		01.98-09.04	170	Komp.Nr. 509228/01, Komp.Nr. 509228/02, Komp.Nr. 509228/03, Komp.Nr. 509476/01, Komp.Nr. 509476/02, Komp.Nr. 591010/10	TNK		0 486 001 024 ⁴		
1214 1214 L		01.98-09.04	100	Komp.Nr. 509228/01, Komp.Nr. 509228/02, Komp.Nr. 509228/03, Komp.Nr. 509476/01, Komp.Nr. 509476/02, Komp.Nr. 591010/10	TNK		0 486 001 024 ⁴		
1215		09.00→	110				0 486 001 024 ⁴		
1215 1215 L 1217 1217 KO 1217 L		01.98-09.04	112/125	Komp.Nr. 509228/01, Komp.Nr. 509228/02, Komp.Nr. 509228/03, Komp.Nr. 509476/01, Komp.Nr. 509476/02, Komp.Nr. 591010/10	TNK		0 486 001 024 ⁴		
1218		09.00→	130				0 486 001 024 ⁴		
1223		01.98-09.04	170	Komp.Nr. 509228/01, Komp.Nr. 509228/02, Komp.Nr. 509228/03, Komp.Nr. 509476/01, Komp.Nr. 509476/02, Komp.Nr. 591010/10	TNK		0 486 001 024 ⁴		
		09.00-09.04	170				0 486 001 024 ⁴		
1223 L		01.98-09.04	170	Komp.Nr. 509228/01, Komp.Nr. 509228/02, Komp.Nr. 509228/03, Komp.Nr. 509476/01, Komp.Nr. 509476/02, Komp.Nr. 591010/10	TNK		0 486 001 024 ⁴		
1225 AF 1225 F		01.98-09.04	180	Komp.Nr. 509228/01, Komp.Nr. 509228/02, Komp.Nr. 509228/03, Komp.Nr. 509476/01, Komp.Nr. 509476/02, Komp.Nr. 591010/10	TNK		0 486 001 024 ⁴		







 ◀ MERCEDES-BENZ Atego [LKN]

1228	01.98-09.04	205	Komp.Nr. 509228/01, Komp.Nr. 509228/02, Komp.Nr. 509228/03, Komp.Nr. 509476/01, Komp.Nr. 509476/02, Komp.Nr. 591010/10	TNK	0 486 001 024 ⁴
	09.00-10.04	205			0 486 001 024 ⁴
1228 L	01.98-09.04	205	Komp.Nr. 509228/01, Komp.Nr. 509228/02, Komp.Nr. 509228/03, Komp.Nr. 509476/01, Komp.Nr. 509476/02, Komp.Nr. 591010/10	TNK	0 486 001 024 ⁴
1317 1317 A 1317 AK 1317 KO 1317 L	01.98-09.04	125	Komp.Nr. 509228/01, Komp.Nr. 509228/02, Komp.Nr. 509228/03, Komp.Nr. 509476/01, Komp.Nr. 509476/02, Komp.Nr. 591010/10	TNK	0 486 001 024 ⁴
1318	09.00→	130			0 486 001 024 ⁴
1323 1323 L 1323 LKO 1325 AF 1325 F	01.98-09.04	170/180	Komp.Nr. 509228/01, Komp.Nr. 509228/02, Komp.Nr. 509228/03, Komp.Nr. 509476/01, Komp.Nr. 509476/02, Komp.Nr. 591010/10	TNK	0 486 001 024 ⁴
1328	01.98-09.04	205	Komp.Nr. 509228/01, Komp.Nr. 509228/02, Komp.Nr. 509228/03, Komp.Nr. 509476/01, Komp.Nr. 509476/02, Komp.Nr. 591010/10	TNK	0 486 001 024 ⁴
	09.00-09.04	205			0 486 001 024 ⁴
1328 AF 1328 F 1328 L	01.98-09.04	205	Komp.Nr. 509228/01, Komp.Nr. 509228/02, Komp.Nr. 509228/03, Komp.Nr. 509476/01, Komp.Nr. 509476/02, Komp.Nr. 591010/10	TNK	0 486 001 024 ⁴
1517 1517 L	01.98-09.04	125	Komp.Nr. 509228/01, Komp.Nr. 509228/02, Komp.Nr. 509228/03, Komp.Nr. 509476/01, Komp.Nr. 509476/02, Komp.Nr. 591010/10	TNK	0 486 001 024 ⁴
1518	09.00→	130			0 486 001 024 ⁴
1523	01.98-09.04	170	Komp.Nr. 509228/01, Komp.Nr. 509228/02, Komp.Nr. 509228/03, Komp.Nr. 509476/01, Komp.Nr. 509476/02, Komp.Nr. 591010/10	TNK	0 486 001 024 ⁴
	09.00-10.04	170			0 486 001 024 ⁴
1523 A 1523 AK 1523 KO 1523 L	01.98-09.04	170	Komp.Nr. 509228/01, Komp.Nr. 509228/02, Komp.Nr. 509228/03, Komp.Nr. 509476/01, Komp.Nr. 509476/02, Komp.Nr. 591010/10	TNK	0 486 001 024 ⁴



		S							
1525 AF		01.98-09.04	180	Komp.Nr. 509228/01, Komp.Nr. 509228/02, Komp.Nr. 509228/03, Komp.Nr. 509476/01, Komp.Nr. 509476/02, Komp.Nr. 591010/10	TNK		0 486 001 024 ⁴		
1528		01.98-09.04	170/205	Komp.Nr. 509228/01, Komp.Nr. 509228/02, Komp.Nr. 509228/03, Komp.Nr. 509476/01, Komp.Nr. 509476/02, Komp.Nr. 591010/10	TNK		0 486 001 024 ⁴		
		09.00-09.04	170/205				0 486 001 024 ⁴		
1528 AF 1528 F 1528 L		01.98-09.04	170/205	Komp.Nr. 509228/01, Komp.Nr. 509228/02, Komp.Nr. 509228/03, Komp.Nr. 509476/01, Komp.Nr. 509476/02, Komp.Nr. 591010/10	TNK		0 486 001 024 ⁴		
1823		05.98-09.04	170/205	Komp.Nr. 509228/01, Komp.Nr. 509228/02, Komp.Nr. 509228/03, Komp.Nr. 509476/01, Komp.Nr. 509476/02, Komp.Nr. 591010/10	TNK		0 486 001 024 ⁴		
		09.00-09.04	170/205				0 486 001 024 ⁴		
1823 AK 1823 K 1823 L 1823 LS		05.98-09.04	170/205	Komp.Nr. 509228/01, Komp.Nr. 509228/02, Komp.Nr. 509228/03, Komp.Nr. 509476/01, Komp.Nr. 509476/02, Komp.Nr. 591010/10	TNK		0 486 001 024 ⁴		
1828		05.98-09.04	170/205	Komp.Nr. 509228/01, Komp.Nr. 509228/02, Komp.Nr. 509228/03, Komp.Nr. 509476/01, Komp.Nr. 509476/02, Komp.Nr. 591010/10	TNK		0 486 001 024 ⁴		
		09.00-09.04	170/205				0 486 001 024 ⁴		
1828 A 1828 AK 1828 K 1828 L 1828 LS		05.98-09.04	170/205	Komp.Nr. 509228/01, Komp.Nr. 509228/02, Komp.Nr. 509228/03, Komp.Nr. 509476/01, Komp.Nr. 509476/02, Komp.Nr. 591010/10	TNK		0 486 001 024 ⁴		
1833		09.00-09.04	240				0 486 001 024 ⁴		
2523 L		05.98-09.04	170	Komp.Nr. 509228/01, Komp.Nr. 509228/02, Komp.Nr. 509228/03, Komp.Nr. 509476/01, Komp.Nr. 509476/02, Komp.Nr. 591010/10	TNK		0 486 001 024 ⁴		
2528		09.00-09.04	205				0 486 001 024 ⁴		
2528 L		05.98-09.04	205	Komp.Nr. 509228/01, Komp.Nr. 509228/02, Komp.Nr. 509228/03, Komp.Nr. 509476/01, Komp.Nr. 509476/02, Komp.Nr. 591010/10	TNK		0 486 001 024 ⁴		
2533		09.00-09.04	240				0 486 001 024 ⁴		





MERCEDES-BENZ Atego [LKN]

2628	05.98-09.04	205	Komp.Nr. 509228/01, Komp.Nr. 509228/02, Komp.Nr. 509228/03, Komp.Nr. 509476/01, Komp.Nr. 509476/02, Komp.Nr. 591010/10	TNK	0 486 001 024 ⁴	
	09.00-09.04	205			0 486 001 024 ⁴	
2628 B 2628 K	05.98-09.04	205	Komp.Nr. 509228/01, Komp.Nr. 509228/02, Komp.Nr. 509228/03, Komp.Nr. 509476/01, Komp.Nr. 509476/02, Komp.Nr. 591010/10	TNK	0 486 001 024 ⁴	
2633	09.00-09.04	240			0 486 001 024 ⁴	

Citaro























	0 530 , G, GUE, K, L	10.06→	210/ 220-260		0 486 000 035 ³	
	0 530 Low Entry MUE					
	0 530 Low Entry UE, UE					

Econic

	1823 L	03.98→	170/175/ 205/210/ 240		0 486 000 035 ³	
	1824					
	1828 L, NGT					
	1829					
	1833					
	2628 L, NGT					
	2629					
	2633					
	3233					

MB

	100 , D	01.87-01.96	43/53-56		1 987 481 094	370
	120					
	140					
	160					
	180					
	100	01.87-06.89	43		0 204 102 371	← 48
					0 204 103 371	↻
					0 204 102 372	→ 48
					0 204 103 372	↻
	100 D	09.87-01.96	53-56		0 204 102 371	← 48
					0 204 103 371	↻
					0 204 102 372	→ 48
					0 204 103 372	↻
				Fg.Nr. BM: 631.349	0 204 102 322	← 52
					0 986 473 199	↻
					0 204 102 323	→ 52
					0 986 474 199	↻

		S							
120			01.87-12.90	53-56			0 204 102 371 0 204 103 371	← 48 	
							0 204 102 372 0 204 103 372	→ 48 	
140			01.87-06.90	56			0 204 102 371 0 204 103 371	← 48 	
							0 204 102 372 0 204 103 372	→ 48 	
160 180			01.87-01.96	56			0 204 102 322 0 986 473 199	← 52 	
							0 204 102 323 0 986 474 199	→ 52 	
									
	100, D 120 140 160 180		01.87-01.96	43/53-56			1 987 481 030	280	
	100, D 120 140 160 180		01.87-01.96	43/53-56			0 986 475 662	↔ 25,4	
									
	100 D		09.87-01.96	53-56	Fg.Nr. →021971 Fg.Nr. 021972→		0 986 480 725 0 986 480 726	25,4 25,4	
	100, D 140		01.87-01.96 01.87-06.90	43/53-56 56	Fg.Nr. 099541→		0 204 031 300 ¹⁰ 0 204 031 300 ¹⁰		
	100 100 D		01.87-06.89 09.87-08.91	43 53-56	Fg.Nr. BM:631.332,333,334 Fg.Nr. BM:631.340,342,343, Fg.Nr. BM:631.344,349		1 987 477 117 1 987 477 326 1 987 477 117 1 987 477 326 1 987 477 327	1464 1413 1464 1413 1640	
			09.91-01.96	55	Fg.Nr. BM:631.332,333,334 Fg.Nr. BM:631.340,342,343, Fg.Nr. BM:631.344,349		1 987 477 117 1 987 477 326 1 987 477 327	1464 1413 1640	
	120		01.87-12.90	55			1 987 477 117 1 987 477 326	1464 1413	
	140		01.87-01.96	56			1 987 477 117	1464	
	160						1 987 477 327	1640	
	180								
	100		01.96→	58/69,8			1 267 000 814 ¹⁶		
	100 D	ABS	02.90-01.96	53-56			0 332 002 171 ²³		





O 100



	CITY	01.94 → 70	0 204 102 322	← 52
			0 986 473 199	
			0 204 102 323	→ 52
			0 986 474 199	

O 303



		01.92-09.92	160-165/191-200/ 213-218/260-269	0 265 150 320 ¹⁸
--	--	-------------	-------------------------------------	------------------------------------

O 404



		01.92-10.99	151/195/200/213/ 250/280	0 265 150 320 ¹⁸
--	--	-------------	-----------------------------	------------------------------------

Sprinter



	310 D	09.96-05.01	70	ATE,	0 986 473 249		← 60		
				JUR	0 986 474 249		→ 60		
				WAB	TEX	0 986 473 250		← 44	
	311 CDI	06.01-12.04	80	BSB,MVB	ATE,	0 986 473 249		← 60	
				JUR	0 986 474 249		→ 60		
				Komp.Nr. 504015/07	BSB,TNK	ATE,	0 986 473 249		← 60
					JUR	0 986 474 249		→ 60	
	312 D	08.99-05.01	77/85	ATE,	0 986 473 249		← 60		
				JUR	0 986 474 249		→ 60		
				WAB	TEX	0 986 473 250		← 44	
	313 CDI	06.01 →	95	BSB,MVB	ATE,	0 986 473 249		← 60	
				JUR	0 986 474 249		→ 60		
				Komp.Nr. 504015/07	BSB,TNK	ATE,	0 986 473 249		← 60
					JUR	0 986 474 249		→ 60	
	412 D	10.99-05.01	85	ATE,	0 986 473 249		← 60		
				JUR	0 986 474 249		→ 60		
				BSY	0 204 102 912		← 44		
					0 986 473 231				
					0 204 102 913		→ 44		
					0 986 474 231				



	413 CDI	06.01 →	95	1 987 476 295
--	---------	---------	----	----------------------





	311 CDI	06.01-12.04	80		ATE	0 986 473 363	← 44,93					
						0 986 474 353	← 51,92					
						0 986 473 353	→ 51,92					
						0 986 474 363	→ 44,93					
						BSY	0 204 102 918	← 52				
							0 986 473 359					
							0 204 102 919	→ 52				
							0 986 474 359					
						312 D	08.99-05.01	77/85		ATE	0 986 473 363	← 44,93
											0 986 474 353	← 51,92
0 986 473 353	→ 51,92											
0 986 474 363	→ 44,93											
BSY	0 204 102 918	← 52										
	0 986 473 359											
	0 204 102 919	→ 52										
	0 986 474 359											
313 CDI	06.01→	95		ATE,	0 986 473 363						← 44,93	
					FDO 0 986 474 363						→ 44,93	
					ATE, 0 986 473 353	← 51,92						
					JUR 0 986 474 353	→ 51,92						
					BSY	0 986 473 359	← 51,96					
						0 986 474 359	→ 51,96					
					BSY,	0 986 473 359	← 51,96					
						FDO 0 986 474 359	→ 51,96					
					412 D	10.99-05.01	85		ATE	0 986 473 363	← 44,93	
										0 986 474 353	← 51,92	
0 986 473 353	→ 51,92											
0 986 474 363	→ 44,93											
BSY	0 204 102 918	← 52										
	0 986 473 359											
	0 204 102 919	→ 52										
	0 986 474 359											
BSB	ATE,	0 986 473 363	← 44,93									
	FDO	0 986 474 363	→ 44,93									
	BSY	0 986 473 359	← 51,96									
		0 986 474 359	→ 51,96									



	310 D	09.96-05.01	70	Komp.Nr. 500014 06	TNK	F 026 003 484	23,8					
						Komp.Nr. 500014/07,	0 204 123 370	25,4				
						Komp.Nr. 520107/02						
						311 CDI	06.01-12.04	80		F 026 003 484	23,8	
						ABS	06.01-12.04	80		0 204 123 370	25,4	
						312 D	08.99-05.01	77/85	Komp.Nr. 500014 06		F 026 003 484	23,8
									Komp.Nr. 500014/07,	TNK	0 204 123 370	25,4
									Komp.Nr. 520107/02			
						313 CDI	06.01→	95			F 026 003 484	23,8
						ABS	06.01→	95			0 204 123 370	25,4
412 D	10.99-05.01	85	Komp.Nr. 500014 06		F 026 003 484	23,8						
			Komp.Nr. 500014/07,	TNK	0 204 123 370	25,4						
			Komp.Nr. 520107/02									
413 CDI	06.01→	95			F 026 003 484	23,8						
ABS	06.01→	95			0 204 123 370	25,4						



◀ MERCEDES-BENZ Sprinter

	311 CDI	06.01→	80/95		0 204 125 741	
	313 CDI					
	413 CDI					
	311 CDI	06.01→	80/95		0 265 224 092 ¹⁶	
	313 CDI				0 265 225 331 ²⁰	
	413 CDI			GS	0 265 224 086 ¹⁹	
					0 265 224 088 ²⁶	
				SEG	0 265 224 090 ²⁶	
			TW	0 265 225 225 ²⁶		

Sprinter [NCV3]















	209 CDI	04.06→	65/80/95/		1 987 476 300	388
	211 CDI		110/135/			
	213 CDI		190			
	215 CDI					
	218 CDI					
	224					
	309 CDI	04.06→	65/80/95/	AA	1 987 476 297	460
	311 CDI		110/135/	AA	1 987 476 300	388
	313 CDI		190			
	315 CDI					
318 CDI						
324						
415 CDI						
418 CDI						
424						
509 CDI						
515 CDI						
518 CDI						
524						



	209 CDI	04.06→	65/80/95/	FCC,TW	1 987 476 300	388
	211 CDI		110/135/			
	213 CDI		190			
	215 CDI					
	218 CDI					
	224					
	311 CDI	04.06→	80	AA,FCC	1 987 476 300	388

	209 CDI	04.06→	65/80/95/		0 204 004 519	← 51
	211 CDI		110/135/		0 204 004 520	→ 51
	213 CDI		190			
	215 CDI					
	218 CDI					
	224					
	309 CDI					
	311 CDI					
	313 CDI					
	315 CDI					
	318 CDI					
	324					
	411 CDI					
	415 CDI					
	418 CDI					
424						

		S							
509 CDI		04.06→	65/80/110/	Hintera. 741.412			0 204 004 519	← 51	
511 CDI			135/190				0 204 004 520	→ 51	
515 CDI				Hintera. 741.414,			0 204 004 523	← 48	
518 CDI				Hintera. 741.416					
524									
<hr/>									
									
	209 CDI	04.06→	65/80/95/		ERH		0 204 051 514		
	211 CDI		110		NON		0 204 255 049	25,4	
	213 CDI								
	215 CDI								
	218 CDI	04.06-09.09	135/190		ERH		0 204 051 514		
	224	04.06→	135/190		NON		0 204 255 049	25,4	
	309 CDI	04.06→	65/80/95/		ERH		0 204 051 514		
	311 CDI		110		NON		0 204 255 049	25,4	
	313 CDI								
	315 CDI								
	318 CDI	04.06-09.09	135/190		ERH		0 204 051 514		
	324	04.06→	135/190		NON		0 204 255 049	25,4	
	411 CDI	04.06→	80				0 204 051 514		
					NON		0 204 255 049	25,4	
	415 CDI	04.06-09.09	110/135/				0 204 051 514		
	418 CDI		190						
	424								
	509 CDI	04.06→	65/80				0 204 051 514		
	511 CDI								
	515 CDI	04.06-09.09	110/135/				0 204 051 514		
	518 CDI		190						
	524								
<hr/>									
	209 CDI	04.06→	65/80/95				0 204 051 341		
	211 CDI								
	213 CDI								
	215 CDI	04.06-09.09	110/135/				0 204 051 341		
	218 CDI		190						
	224								
	309 CDI	04.06→	65/80/95				0 204 051 341		
	311 CDI								
	313 CDI								
	315 CDI	04.06-09.09	110/135/				0 204 051 341		
	318 CDI		190						
	324								
	411 CDI	04.06→	80				0 204 051 341		
	415 CDI	04.06-09.09	110/135/				0 204 051 341		
	418 CDI		190						
	424								
	509 CDI	04.06→	65/80				0 204 051 341		
	511 CDI								
	515 CDI	04.06-09.09	110/135/				0 204 051 341		
	518 CDI		190						
	524								
<hr/>									
	209 CDI	04.06→	65/80/95/		FMR,TW		1 987 482 028	1867	
	211 CDI		110/135/						
	213 CDI		190						
	215 CDI								
	218 CDI								
	224								
	309 CDI	04.06→	65		FLR,TW		1 987 482 029	2522	
					FMR,TW		1 987 482 028	1867	





 ◀ MERCEDES-BENZ Sprinter [NCV3]

311 CDI	04.06→	80	TW	1987 482 028	1867
				1987 482 029	2522
313 CDI	04.06→	95	FLR,TW	1987 482 029	2522
			FMR,TW	1987 482 028	1867
315 CDI	04.06→	110	TW	1987 482 028	1867
				1987 482 029	2522
318 CDI	04.06→	65/80/110/	FLR,TW	1987 482 029	2522
324		135/190	FMR,TW	1987 482 028	1867
411 CDI					
415 CDI					
418 CDI					
424					
509 CDI					
511 CDI					
515 CDI					
518 CDI					
524					

	209 CDI	04.06-01.09	65/80/95/	Fg.Nr. →N 416268	AA,NE5	0 265 235 028 ²⁶
	211 CDI		110/135/			
	213 CDI		190			
	215 CDI					
	218 CDI					
	224					
	309 CDI					
	311 CDI					
	313 CDI					
	315 CDI					
	318 CDI					
	324					

	209 CDI	04.06→	65/80/95/			0 265 005 774
	211 CDI		110/135/			
	213 CDI		190			
	215 CDI					
	218 CDI					
	224					
	309 CDI					
	311 CDI					
	313 CDI					
	315 CDI					
	318 CDI					
	324					
	411 CDI					
	415 CDI					
	418 CDI					
	424					
	509 CDI					
	511 CDI					
	515 CDI					
	518 CDI					
	524					



Sprinter [T1N]



	208 CDI, D	02.95-05.06	58-60/75/		AA	1 987 476 294	490
	210 D		80/90/95/		AA	1 987 476 295	
	211 CDI		105-108/				
	212 D		115				
	213 CDI						
	214 , NGT						
	216 CDI						
	308 CDI, D, D James Cook						
	310 D, D James Cook						
	311 CDI						
	312 D, D James Cook						
	313 CDI						
	314 , James Cook, NGT						
	316 CDI, CDI James Cook						
408 CDI, D							
410 D	02.95-05.06	58-60/75/		AA	1 987 476 294	490	
411 CDI		80/90/95/		AA	1 987 476 295		
412 D		105-108/					
413 CDI		115					
414							
416 CDI							
	208 CDI, D	02.95-05.06	58-60/75/	Komp.Nr. 504015/06,	BSB,TNK BSY	0 204 102 912	← 44
	210 D		80/90/95/	Komp.Nr. 504015/08,		0 986 473 231	☺
	211 CDI		105-108/	Komp.Nr. 504015/50		0 204 102 913	→ 44
	212 D		115			0 986 474 231	☺
	213 CDI			Komp.Nr. 504015/07,	BSB,TNK ATE,	0 986 473 249	☺ ← 60
	214 , NGT			Komp.Nr. 504015/04,	JUR	0 986 474 249	☺ → 60
	216 CDI			Komp.Nr. 504025/28,			
	308 CDI, D, D James Cook			Komp.Nr. 504015/29			
	310 D, D James Cook			Komp.Nr. 504025/13	BSB,TNK ATE	0 986 473 353	☺ ← 51,92
	311 CDI					0 986 474 353	☺ → 51,92
	312 D, D James Cook			Vordera. →S073676,	BSB,TNK ATE,	0 986 473 249	☺ ← 60
	313 CDI			Y106210,	JUR	0 986 474 249	☺ → 60
	314 , James Cook, NGT			Komp.Nr. 504015/04,			
	316 CDI, CDI James Cook			Komp.Nr. 504015/07			
408 CDI, D	02.95-05.06	58/60/75/			ATE	0 986 473 353	☺ ← 51,92
410 D		80/90/95/				0 986 474 353	☺ → 51,92
411 CDI		105-108/		BSY	0 204 102 912	← 44	
412 D		115			0 986 473 231	☺	
413 CDI					0 204 102 913	→ 44	
414					0 986 474 231	☺	
416 CDI							
	208 CDI, D	02.95-05.06	58-60/75/			1 987 476 295	
	210 D		80/90/95/		AA	1 987 476 300	388
	211 CDI		105-108/				
	212 D		115				
	213 CDI						
	216 CDI						















2 ◀ MERCEDES-BENZ Sprinter [T1N]

308 CDI, D, D James Cook	02.95-05.06	58/60/75/		AA	1987 476 300	388
310 D, D James Cook		80/90/95/		AA	1987 476 295	
311 CDI		105-108/				
312 D, D James Cook		115				
313 CDI						
314, James Cook, NGT						
316 CDI, CDI James Cook						
408 CDI, D	02.95-05.06	58/60/75/			1987 476 295	
410 D		80/90/95/		AA	1987 476 300	388
411 CDI		105-108/				
412 D		115				
413 CDI						
414						
416 CDI						
616 CDI						

	208 CDI, D	02.95-05.06	58-60/75/		0986 473 363	← 44,93
	210 D		80/90/95/		0986 474 363	→ 44,93
	211 CDI		105-108/			
	212 D		115			
	213 CDI					
	214, NGT					
216 CDI						
308 CDI, D, D James Cook	02.95-05.06	58/60/75/		BSB ATE	0986 474 353	← 51,92
310 D, D James Cook		80/90/95/			0986 473 353	→ 51,92
311 CDI		105-108/		BSY	0 204 102 918	← 52
312 D, D James Cook		115			0986 473 359	→ 52
313 CDI					0 204 102 919	→ 52
314, James Cook, NGT					0986 474 359	→ 52
316 CDI, CDI James Cook				BSB ATE,	0986 473 353	← 51,92
				JUR	0986 474 353	→ 51,92
				BSY,	0986 473 359	← 51,96
				FDO	0986 474 359	→ 51,96
				BSY,	0986 473 359	← 51,96
				JUR	0986 474 359	→ 51,96
408 CDI, D	02.95-05.06	58/60/75/	Komp.Nr. 504015/92	TNK BSY	0 204 102 912	← 44
410 D		80/90/95/			0986 473 231	→ 44
411 CDI		105-108/			0 204 102 913	→ 44
412 D		115			0986 474 231	→ 44
413 CDI						
414						
416 CDI						

	208 CDI	04.00-05.06	60		NON	F 026 003 484	23,8
	208 D	02.95-03.00	58-60/75			F 026 003 484	23,8
	210 D	01.97-03.00	58-60/75			F 026 003 484	23,8
	211 CDI	04.00-05.06	80		NON	F 026 003 484	23,8
	212 D	02.95-03.00	90			F 026 003 484	23,8
	213 CDI	04.00-05.06	95		NON	F 026 003 484	23,8
	214	02.95-03.00	105			F 026 003 484	23,8
	214, NGT	04.00-05.06	60/95/105-108/115		NON	F 026 003 484	23,8
	216 CDI	04.00-05.06	60/95/105-108/115		NON	F 026 003 484	23,8
	308 CDI						
	308 D	ABO 02.95-03.00	58/75			F 026 003 484	23,8
	308 D James Cook	ABS 02.95-03.00	58/75			0 204 123 370	25,4
	310 D	ABO 01.97-03.00	58/75			F 026 003 484	23,8
	310 D James Cook	ABS 01.97-03.00	58/75			0 204 123 370	25,4
	311 CDI	04.00-05.06	80		NON	F 026 003 484	23,8
	312 D	ABO 02.95-03.00	90			F 026 003 484	23,8
	312 D James Cook	ABS 02.95-03.00	90			0 204 123 370	25,4

		S							
313 CDI		04.00-05.06	95/105-108			NON	F 026 003 484	23,8	
314									
314	ABO	02.95-08.02	105				F 026 003 484	23,8	
314 James Cook	ABS	02.95-08.02	105				O 204 123 370	25,4	
314 James Cook		08.02-05.06	105-108			NON	F 026 003 484	23,8	
314 NGT		04.00-05.06	95/115			NON	F 026 003 484	23,8	
316 CDI, CDI James Cook		04.00-05.06	95/115			NON	F 026 003 484	23,8	
408 CDI		04.00-05.06	60	Fg.Nr. →R400726, →A937136			F 026 003 484	23,8	
408 D		02.95-03.00	58/75	Fg.Nr. →P 707202 Fg.Nr. P 707203→			F 026 003 484 O 204 123 370	23,8 25,4	
410 D		01.97-03.00	58/75	Fg.Nr. →P 707202 Fg.Nr. P 707203→			F 026 003 484 O 204 123 370	23,8 25,4	
411 CDI		04.00-05.06	80	Fg.Nr. →R400726, →A937136			F 026 003 484	23,8	
412 D		02.95-03.00	90	Fg.Nr. →P 707202 Fg.Nr. P 707203→			F 026 003 484 O 204 123 370	23,8 25,4	
413 CDI		04.00-05.06	95	Fg.Nr. →R400726, →A937136			F 026 003 484	23,8	
414		02.95-03.00	105	Fg.Nr. →P 707202 Fg.Nr. P 707203→			F 026 003 484 O 204 123 370	23,8 25,4	
414		04.00-05.06	105-108/	Fg.Nr. →R400726,			F 026 003 484	23,8	
416 CDI			115	→A937136					
 208 CDI		04.00-05.06	60/80/95/	Fg.Nr. →R 400726,			O 204 125 741		
211 CDI			105-108/	→A 905511					
213 CDI			115						
214 , NGT									
216 CDI									
308 CDI		02.95-05.06	60/80/95/	Fg.Nr. R400727→,			O 204 125 741		
311 CDI			105-108/	A905512→					
313 CDI			115						
314 , James Cook, NGT									
316 CDI, CDI James Cook									
408 CDI		04.00-05.06	60/80/95/	Fg.Nr. →R 400726,			O 204 125 741		
411 CDI			105-108	→A 906425					
413 CDI									
414									
416 CDI		04.00-05.06	115	Fg.Nr. →R 400726, →A 906425			O 204 125 741		
		10.04-05.06	115				O 204 125 741		
 208 CDI, D		02.95-05.06	58-60/75/				O 986 486 053		
210 D			80/90/95/						
211 CDI			105						
212 D									
213 CDI									
214 , NGT									
216 CDI		04.00-05.06	115	Komp.Nr. 500011/01			O 986 486 053		





 ◀ MERCEDES-BENZ Sprinter [T1N]

308 CDI, D, D James Cook	02.95-05.06	58/60/75/			0986 486 053
310 D, D James Cook		80/90/95/			
311 CDI		105-108/			
312 D, D James Cook		115			
313 CDI					
314, James Cook, NGT					
316 CDI, CDI James Cook					
408 CDI, D					
410 D					
411 CDI					
412 D					
413 CDI					
414					
416 CDI					
616 CDI					

	208 D	02.95-05.06	58-60/75/	Komp.Nr. 504099/01		0986 486 546
	210 D		90/95/			
	212 D		105-108			
	214, NGT					
	308 D, D James Cook	02.95-05.06	58/75/90/			0986 486 546
	310 D, D James Cook		95/105-108			
	312 D, D James Cook					
	314, NGT					
	408 D	02.95-05.06	58/75/90/	Komp.Nr. 504099/01		0986 486 546
	410 D		105-108			
	412 D					
	414					

	208 CDI, D	02.95-05.06	58-60/75/			0 204 131 248 ¹⁰
	210 D		80/90/95/			
	211 CDI		105-108/			
	212 D		115			
	213 CDI					
	214, NGT					
	308 CDI, D, D James Cook	02.95-05.06	58/60/75/	Komp.Nr. 500042/02,	TNK	0 204 131 248 ¹⁰
	310 D, D James Cook			Komp.Nr. 500042/04,		
	311 CDI			Komp.Nr. 500042/05,		
	312 D, D James Cook			Komp.Nr. 500042/50		
	313 CDI		80/90/95/	Komp.Nr. 500042/06	TNK	0 204 131 249 ¹⁰
	314, James Cook, NGT		105-108/	Komp.Nr. 500042/07	TNK	0 204 131 250 ¹⁰
	316 CDI, CDI James Cook		115			
	408 CDI	ABO 04.00-05.01	60	Komp.Nr. 500042/03	TNK	0 204 131 251 ¹⁰
		ABS 04.00-05.06	60	Komp.Nr. 500042/05	TNK	0 204 131 248 ¹⁰
	408 D	02.95-03.00	58	Fg.Nr. P 516915→,	TNK	0 204 131 251 ¹⁰
			Komp.Nr. 500042/03			
			Komp.Nr. 500042/02,	TNK	0 204 131 248 ¹⁰	
			Komp.Nr. 500042/04,			
			Komp.Nr. 500042/05,			
			Komp.Nr. 500042/50			
410 D	01.97-03.00	75	Komp.Nr. 500042/02,	TNK	0 204 131 248 ¹⁰	
			Komp.Nr. 500042/04,			
			Komp.Nr. 500042/05,			
			Komp.Nr. 500042/50			
411 CDI	ABO 04.00-05.01	80	Komp.Nr. 500042/03	TNK	0 204 131 251 ¹⁰	
	ABS 04.00-05.06	80	Komp.Nr. 500042/05	TNK	0 204 131 248 ¹⁰	
412 D	02.95-03.00	90	Fg.Nr. P 516915→,	TNK	0 204 131 251 ¹⁰	
			Komp.Nr. 500042/03			
			Komp.Nr. 500042/02,	TNK	0 204 131 248 ¹⁰	
			Komp.Nr. 500042/04,			
			Komp.Nr. 500042/05,			
			Komp.Nr. 500042/50			

		S							
413 CDI	ABO	04.00-05.01	95	Komp.Nr. 500042/03	TNK	0 204 131 251 ¹⁰			
	ABS	04.00-05.06	95	Komp.Nr. 500042/05	TNK	0 204 131 248 ¹⁰			
414		02.95-03.00	105	Fg.Nr. P 516915→, Komp.Nr. 500042/03	TNK	0 204 131 251 ¹⁰			
				Komp.Nr. 500042/02, Komp.Nr. 500042/04, Komp.Nr. 500042/05, Komp.Nr. 500042/50	TNK	0 204 131 248 ¹⁰			
414	ABO	04.00-05.01	105-108/ 115	Komp.Nr. 500042/03	TNK	0 204 131 251 ¹⁰			
416 CDI	ABS	04.00-05.06	105-108/ 115	Komp.Nr. 500042/05	TNK	0 204 131 248 ¹⁰			
208 CDI		04.00-05.06	60		BDS,R30	1 987 477 856	1423		
					BDS,R30	1 987 477 853	1443		
				Komp.Nr. 500038/02	R35,TNK	1 987 477 854	1998		
				Komp.Nr. 500038/03	R40,TNK	1 987 477 855	2468		
				Komp.Nr. 504013/01	TNK	1 987 477 852	↔ 1522		
				Komp.Nr. 504013/02	TNK	1 987 477 858	← 1532		
						1 987 477 859	→ 1532		
				Komp.Nr. 504013/03	TNK	1 987 477 702	→ 1688		
						1 987 477 703	← 1688		
				Komp.Nr. 504013/04	TNK	1 987 477 857	↔ 1553		
				Komp.Nr. 504013/05	TNK	1 987 477 860	← 1580		
						1 987 477 861	→ 1575		
208 D		02.95-03.00	58-60		BDS,R30	1 987 477 856	1423		
					MBB	1 987 477 118	→ 1862		
						1 987 477 119	← 1862		
					BDS,R30	1 987 477 853	1443		
				Komp.Nr. 500038/02	R35,TNK	1 987 477 854	1998		
				Komp.Nr. 500038/03	R40,TNK	1 987 477 855	2468		
				Komp.Nr. 504013/01	TNK	1 987 477 852	↔ 1522		
				Komp.Nr. 504013/02	TNK	1 987 477 858	← 1532		
						1 987 477 859	→ 1532		
				Komp.Nr. 504013/03	TNK	1 987 477 702	→ 1688		
						1 987 477 703	← 1688		
				Komp.Nr. 504013/04	TNK	1 987 477 857	↔ 1553		
				Komp.Nr. 504013/05	TNK	1 987 477 860	← 1580		
						1 987 477 861	→ 1575		
210 D		01.97-05.06	75/80		BDS,R30	1 987 477 856	1423		
211 CDI					BDS,R30	1 987 477 853	1443		
				Komp.Nr. 500038/02	R35,TNK	1 987 477 854	1998		
				Komp.Nr. 500038/03	R40,TNK	1 987 477 855	2468		
				Komp.Nr. 504013/01	TNK	1 987 477 852	↔ 1522		
				Komp.Nr. 504013/02	TNK	1 987 477 858	← 1532		
						1 987 477 859	→ 1532		
				Komp.Nr. 504013/03	TNK	1 987 477 702	→ 1688		
						1 987 477 703	← 1688		
				Komp.Nr. 504013/04	TNK	1 987 477 857	↔ 1553		
				Komp.Nr. 504013/05	TNK	1 987 477 860	← 1580		
						1 987 477 861	→ 1575		





◀ MERCEDES-BENZ Sprinter [T1N]

212 D	02.95-03.00	90	BDS,R30	1987 477 856	1423			
			MBB	1987 477 118	→ 1862			
				1987 477 119	← 1862			
			BDS,R30	1987 477 853	1443			
			Komp.Nr. 500038/02	R35,TNK	1987 477 854	1998		
			Komp.Nr. 500038/03	R40,TNK	1987 477 855	2468		
			Komp.Nr. 504013/01	TNK	1987 477 852	↔ 1522		
			Komp.Nr. 504013/02	TNK	1987 477 858	← 1532		
					1987 477 859	→ 1532		
			Komp.Nr. 504013/03	TNK	1987 477 702	→ 1688		
					1987 477 703	← 1688		
			Komp.Nr. 504013/04	TNK	1987 477 857	↔ 1553		
			Komp.Nr. 504013/05	TNK	1987 477 860	← 1580		
					1987 477 861	→ 1575		
213 CDI	04.00-05.06	95	BDS,R30	1987 477 856	1423			
			BDS,R30	1987 477 853	1443			
			Komp.Nr. 500038/02	R35,TNK	1987 477 854	1998		
			Komp.Nr. 500038/03	R40,TNK	1987 477 855	2468		
			Komp.Nr. 504013/01	TNK	1987 477 852	↔ 1522		
			Komp.Nr. 504013/02	TNK	1987 477 858	← 1532		
					1987 477 859	→ 1532		
			Komp.Nr. 504013/03	TNK	1987 477 702	→ 1688		
					1987 477 703	← 1688		
			Komp.Nr. 504013/04	TNK	1987 477 857	↔ 1553		
			Komp.Nr. 504013/05	TNK	1987 477 860	← 1580		
					1987 477 861	→ 1575		
			214	02.95-03.00	105	BDS,R30	1987 477 856	1423
						MBB	1987 477 118	→ 1862
	1987 477 119	← 1862						
BDS,R30	1987 477 853	1443						
Komp.Nr. 500038/02	R35,TNK	1987 477 854				1998		
Komp.Nr. 500038/03	R40,TNK	1987 477 855				2468		
Komp.Nr. 504013/01	TNK	1987 477 852				↔ 1522		
Komp.Nr. 504013/02	TNK	1987 477 858				← 1532		
		1987 477 859				→ 1532		
Komp.Nr. 504013/03	TNK	1987 477 702				→ 1688		
		1987 477 703				← 1688		
Komp.Nr. 504013/04	TNK	1987 477 857				↔ 1553		
Komp.Nr. 504013/05	TNK	1987 477 860				← 1580		
		1987 477 861				→ 1575		
214 214 NGT	04.00-05.06	95/105-108 /115	BDS,R30	1987 477 856	1423			
			BDS,R30	1987 477 853	1443			
			Komp.Nr. 500038/02	R35,TNK	1987 477 854	1998		
			Komp.Nr. 500038/03	R40,TNK	1987 477 855	2468		
			Komp.Nr. 504013/01	TNK	1987 477 852	↔ 1522		
			Komp.Nr. 504013/02	TNK	1987 477 858	← 1532		
					1987 477 859	→ 1532		
			Komp.Nr. 504013/03	TNK	1987 477 702	→ 1688		
					1987 477 703	← 1688		
			Komp.Nr. 504013/04	TNK	1987 477 857	↔ 1553		
			Komp.Nr. 504013/05	TNK	1987 477 860	← 1580		
					1987 477 861	→ 1575		



		S								
216 CDI		04.00-05.06	95/105-108 /115				BDS,R30	1 987 477 856	1423	
							BDS ,R30	1 987 477 853	1443	
							Komp.Nr. 500038/02	R35,TNK	1 987 477 854	1998
							Komp.Nr. 500038/03	R40,TNK	1 987 477 855	2468
							Komp.Nr. 504013/01	TNK	1 987 477 852	↔ 1522
							Komp.Nr. 504013/02	TNK	1 987 477 858	← 1532
								1 987 477 859	→ 1532	
							Komp.Nr. 504013/03	TNK	1 987 477 702	→ 1688
								1 987 477 703	← 1688	
							Komp.Nr. 504013/04	TNK	1 987 477 857	↔ 1553
							Komp.Nr. 504013/05	TNK	1 987 477 860	← 1580
								1 987 477 861	→ 1575	
308 CDI, D, D James Cook		02.95-05.06	58/60/75/				BDS,R30	1 987 477 856	1423	
310 D, D James Cook			80/90/95/				BDS ,R30	1 987 477 853	1443	
311 CDI			105-108/				Hintera. 741.408,	TNK	1 987 477 857	↔ 1553
312 D, D James Cook			115				Komp.Nr. 504013/04			
313 CDI							Komp.Nr. 500038/02	R35,TNK	1 987 477 854	1998
314 , James Cook, NGT							Komp.Nr. 500038/03	R40,TNK	1 987 477 855	2468
316 CDI, CDI James Cook							Komp.Nr. 500038/04	R35,TNK	1 987 482 131	228
							Komp.Nr. 500038/05	R40,TNK	1 987 477 880	2448
							Komp.Nr. 504013/02	TNK	1 987 477 858	← 1532
								1 987 477 859	→ 1532	
							Komp.Nr. 504013/05	TNK	1 987 477 860	← 1580
								1 987 477 861	→ 1575	
408 CDI		04.00-05.06	60				BDS,R30	1 987 477 856	1423	
							BDS ,R30	1 987 477 853	1443	
							Komp.Nr. 500038/02	R35,TNK	1 987 477 854	1998
							Komp.Nr. 500038/03	R40,TNK	1 987 477 855	2468
							Komp.Nr. 504013/01	TNK	1 987 477 852	↔ 1522
							Komp.Nr. 504013/02	TNK	1 987 477 858	← 1532
								1 987 477 859	→ 1532	
							Komp.Nr. 504013/03	TNK	1 987 477 702	→ 1688
								1 987 477 703	← 1688	
							Komp.Nr. 504013/04	TNK	1 987 477 857	↔ 1553
							Komp.Nr. 504013/05	TNK	1 987 477 860	← 1580
								1 987 477 861	→ 1575	
408 D		02.95-03.00	58				BDS,R30	1 987 477 856	1423	
							MBB	1 987 477 118	→ 1862	
								1 987 477 119	← 1862	
							BDS ,R30	1 987 477 853	1443	
							Komp.Nr. 500038/02	R35,TNK	1 987 477 854	1998
							Komp.Nr. 500038/03	R40,TNK	1 987 477 855	2468
							Komp.Nr. 504013/01	TNK	1 987 477 852	↔ 1522
							Komp.Nr. 504013/02	TNK	1 987 477 858	← 1532
								1 987 477 859	→ 1532	
							Komp.Nr. 504013/03	TNK	1 987 477 702	→ 1688
								1 987 477 703	← 1688	
							Komp.Nr. 504013/04	TNK	1 987 477 857	↔ 1553
							Komp.Nr. 504013/05	TNK	1 987 477 860	← 1580
								1 987 477 861	→ 1575	
410 D		02.95-05.06	75/80/90/				BDS,R30	1 987 477 856	1423	
411 CDI			95/105-108				BDS ,R30	1 987 477 853	1443	
412 D							Komp.Nr. 500038/02	R35,TNK	1 987 477 854	1998
413 CDI							Komp.Nr. 500038/03	R40,TNK	1 987 477 855	2468
414							Komp.Nr. 504013/01	TNK	1 987 477 852	↔ 1522
							Komp.Nr. 504013/02	TNK	1 987 477 858	← 1532
								1 987 477 859	→ 1532	
							Komp.Nr. 504013/03	TNK	1 987 477 702	→ 1688
								1 987 477 703	← 1688	
							Komp.Nr. 504013/04	TNK	1 987 477 857	↔ 1553
							Komp.Nr. 504013/05	TNK	1 987 477 860	← 1580
								1 987 477 861	→ 1575	





◀ MERCEDES-BENZ Sprinter [T1N]

	416 CDI	04.00-05.06	115	BDS,R30	1987 477 856	1423				
				BDS,R30	1987 477 853	1443				
				Komp.Nr. 500038/02	R35,TNK	1987 477 854	1998			
				Komp.Nr. 500038/03	R40,TNK	1987 477 855	2468			
				Komp.Nr. 504013/01	TNK	1987 477 852	↔ 1522			
				Komp.Nr. 504013/02	TNK	1987 477 858	← 1532			
						1987 477 859	→ 1532			
				Komp.Nr. 504013/03	TNK	1987 477 702	→ 1688			
						1987 477 703	← 1688			
				Komp.Nr. 504013/04	TNK	1987 477 857	↔ 1553			
				Komp.Nr. 504013/05	TNK	1987 477 860	← 1580			
						1987 477 861	→ 1575			
						1987 477 855	2468			
					10.04-05.06	115				
							Komp.Nr. BE 2	1987 477 880	2448	

	208 CDI	04.00-05.06	60		GS	0 265 224 088 ²⁶
					SEG	0 265 224 090 ²⁶
	208 D	02.95-03.00	58-60/75	Fg.Nr. P718187→, R000001→	TNK	0 265 220 489 ¹⁹
	210 D	01.97-03.00	58-60/75	Fg.Nr. P718187→, R000001→	TNK	0 265 220 489 ¹⁹
	211 CDI	04.00-05.06	80		GS	0 265 224 088 ²⁶
					SEG	0 265 224 090 ²⁶
	212 D	02.95-03.00	90	Fg.Nr. P718187→, R000001→	TNK	0 265 220 489 ¹⁹
	213 CDI	04.00-05.06	95		GS	0 265 224 088 ²⁶
					SEG	0 265 224 090 ²⁶
	214	02.95-05.06	95/105-108	Fg.Nr. P718187→, R000001→	TNK	0 265 220 489 ¹⁹
	214 NGT					
	216 CDI	04.00-05.06	115		GS	0 265 224 088 ²⁶
					SEG	0 265 224 090 ²⁶
	308 CDI	04.00-05.06	60		ERH	0 265 225 331 ²⁶
					SEG	0 265 224 090 ¹⁴
Fg.Nr. →R337626					NON	0 265 224 088 ¹⁴
Fg.Nr. R337627→, A901274→					NON	0 265 224 086 ¹⁴
					TNK	0 265 225 302 ²⁶
Fg.Nr. →R636248					NON	0 265 225 225 ²⁶
Fg.Nr. R636249→					NON	0 265 225 300 ²⁶
308 D	02.95-03.00	58/75	Fg.Nr. P718187→, R000001→		0 265 220 489 ¹³	
308 D James Cook						
310 D	01.97-03.00	58/75	Fg.Nr. P718187→, R000001→		0 265 220 489 ¹³	
310 D James Cook						
311 CDI	04.00-05.06	80		ERH	0 265 225 331 ²⁶	
				SEG	0 265 224 090 ¹⁴	
				Fg.Nr. →R337626	NON	0 265 224 088 ¹⁴
				Fg.Nr. R337627→, A901274→	NON	0 265 224 086 ¹⁴
					TNK	0 265 225 302 ²⁶
				Fg.Nr. →R636248	NON	0 265 225 225 ²⁶
				Fg.Nr. R636249→	NON	0 265 225 300 ²⁶
312 D	02.95-03.00	90	Fg.Nr. P718187→, R000001→		0 265 220 489 ¹³	
312 D James Cook						
313 CDI	04.00-05.06	95		ERH	0 265 225 331 ²⁶	
				SEG	0 265 224 090 ¹⁴	
				Fg.Nr. →R337626	NON	0 265 224 088 ¹⁴
				Fg.Nr. R337627→, A901274→	NON	0 265 224 086 ¹⁴
					TNK	0 265 225 302 ²⁶
				Fg.Nr. →R636248	NON	0 265 225 225 ²⁶
				Fg.Nr. R636249→	NON	0 265 225 300 ²⁶

		S							
314		02.95-05.06	95/105-108			ERH	0 265 225 331 ²⁶		
314 James Cook						GS	0 265 225 304 ²⁶		
314 NGT						NON	0 265 224 088 ¹⁴		
						SEG	0 265 224 090 ¹⁴		
					Fg.Nr. P718187→, R000001→		0 265 220 489 ¹³		
316 CDI		04.00-05.06	115			ERH	0 265 225 331 ²⁶		
						GS, NON	0 265 224 086 ¹⁴		
							0 265 225 302 ²⁶		
						SEG	0 265 224 090 ¹⁴		
		10.04-05.06	115		Fg.Nr. →R337626	NON	0 265 224 088 ¹⁴		
					Fg.Nr. R337627→, A901274→	NON	0 265 224 086 ¹⁴		
						TNK	0 265 225 302 ²⁶		
					Fg.Nr. →R636248	NON	0 265 225 225 ²⁶		
					Fg.Nr. R636249→	NON	0 265 225 300 ²⁶		
316 CDI James Cook		04.01-05.06	115			ERH	0 265 225 331 ²⁶		
						SEG	0 265 224 090 ¹⁴		
					Fg.Nr. →R337626	NON	0 265 224 088 ¹⁴		
					Fg.Nr. R337627→, A901274→	NON	0 265 224 086 ¹⁴		
						TNK	0 265 225 302 ²⁶		
					Fg.Nr. →R636248	NON	0 265 225 225 ²⁶		
					Fg.Nr. R636249→	NON	0 265 225 300 ²⁶		
408 CDI		04.00-05.06	60			GS	0 265 224 088 ²⁶		
						SEG	0 265 224 090 ²⁶		
408 D		02.95-03.00	58/75		Fg.Nr. P718187→, R000001→	TNK	0 265 220 489 ¹⁹		
410 D		01.97-03.00	58/75		Fg.Nr. P718187→, R000001→	TNK	0 265 220 489 ¹⁹		
411 CDI		04.00-05.06	80			GS	0 265 224 088 ²⁶		
						SEG	0 265 224 090 ²⁶		
412 D		02.95-03.00	90		Fg.Nr. P718187→, R000001→	TNK	0 265 220 489 ¹⁹		
413 CDI		04.00-05.06	95			GS	0 265 224 088 ²⁶		
						SEG	0 265 224 090 ²⁶		
414		02.95-03.00	105		Fg.Nr. P718187→, R000001→	TNK	0 265 220 489 ¹⁹		
		04.00-05.06	105-108				0 265 224 088 ¹⁹		
416 CDI		04.00-05.06	115			GS	0 265 224 088 ²⁶		
						SEG	0 265 224 090 ²⁰		
							0 265 224 090 ²⁶		
		10.04-05.06	115			GS	0 265 224 086 ²⁰		
616 CDI		02.01-05.06	115				0 265 224 082 ²⁰		
208 CDI, D		02.95-05.06	58-60/75/			H01	0 265 004 009 ³		
210 D			80/90/95/				0 265 004 010 ⁴		
211 CDI			105-108/						
212 D			115						
213 CDI									
214, NGT									
216 CDI									
308 CDI, D, D James Cook									
310 D, D James Cook									
311 CDI									
312 D, D James Cook									
313 CDI									
314, James Cook, NGT									
316 CDI, CDI James Cook									
408 CDI, D									





	◀ MERCEDES-BENZ Sprinter [T1N]								
	410 D	02.95-05.06	58-60/75/		H01	0 265 004 009 ³			
	411 CDI		80/90/95/			0 265 004 010 ⁴			
	412 D		105-108/						
	413 CDI		115						
	414								
	416 CDI								
	616 CDI								

Unimog

	U 1000, 1200, 1250, 1250 L	01.92→	75/92-115			0 265 105 026 ¹⁶		
	U 1400, 1450, 1600, 1650, 1650 L							
	U 3000/4000	09.02→	110/130/	Komp.Nr. 515542/01,	TNK	0 486 001 024 ⁴		
	U 4000/5000		160/170	Komp.Nr. 515542/02				
	U 5000							

Vario [T2W]

	0 810, 812, 814, 815	01.96→	75/90/95/	Komp.Nr. 504099/01	TNK	0 986 486 546		
	512 D		100-112/					
	612 D		115/130					
	613 D							
	614 D							
	615 D							
	616 D							
	618 D							
	810 DT							
	812 D							
	813 D/DA							
	814 D/DA							
	815 D/DA							
	816 D/DA							
	818 D/DA							

	0 810, 812, 814, 815	01.96-09.06	75/90/	Komp.Nr. 514091/02,	TNK	0 204 131 323 ¹⁰		
	512 D		100-112/	Komp.Nr. 514091/09				
	612 D		130	Komp.Nr. 514091/04,	TNK	0 204 131 325 ¹⁰		
	614 D			Komp.Nr. 514091/10				
	615 D							
	618 D							
	810 DT							
	812 D							
	814 D/DA							
	815 D/DA							
	818 D							







	0 810, 812, 814, 815	01.96→	75/90/95/ 100-112/ 115/130	Komp.Nr. 514088/03	TNK	0 265 216 444 ¹⁶		
	512 D							
	612 D							
	613 D							
	614 D							
	615 D							
	616 D							
	618 D							
	810 DT							
	812 D							
	813 D/DA							
	814 D/DA							
	815 D/DA							
	816 D/DA							
	818 D/DA							

	0 810, 812, 814, 815	01.96→	75/90/95/ 100-112/ 115/130		AA LAB AA RAB	0 265 004 012 ³ 0 265 004 015 ⁴ 0 265 004 011 ³ 0 265 004 016 ⁴		
	512 D							
	612 D							
	613 D							
	614 D							
	615 D							
	616 D							
	618 D							
	810 DT							
	812 D							
	813 D/DA							
	814 D/DA							
	815 D/DA							
	816 D/DA							
	818 D/DA							



Vito [638 T0N]

								
	108 CDI, D	11.95-09.03	60/72/75/ 90/95/100/ 105			1 987 481 005	495	
	110 CDI, D							
	112 CDI							
	113							
	114							
	108 CDI	04.99-09.03	60		BSY, 0 204 102 914 FDO, 0 986 473 362 JUR 0 204 102 915 0 986 474 362		← 60 ↻ → 60 ↻	
	108 D	11.95-09.03	60		ATE 0 986 473 235 0 986 474 235 BSY, 0 204 102 914 FDO, 0 986 473 362 JUR 0 204 102 915 0 986 474 362		↻ ← 60 ↻ → 60 ← 60 ↻ → 60 ↻	
	110 CDI	04.99-09.03	75		BSY, 0 204 102 914 FDO, 0 986 473 362 JUR 0 204 102 915 0 986 474 362		← 60 ↻ → 60 ↻	
	110 D	11.95-09.03	72		ATE 0 986 473 235 0 986 474 235 BSY, 0 204 102 914 FDO, 0 986 473 362 JUR 0 204 102 915 0 986 474 362		↻ ← 60 ↻ → 60 ← 60 ↻ → 60 ↻	

◀ MERCEDES-BENZ Vito [638 T0N]									
	112 CDI	11.95-09.03	90/95			BSY, 0 204 102 914	← 60		
	113					FDO, 0 986 473 362			
						JUR 0 204 102 915	→ 60		
						0 986 474 362			
	113	11.95-09.03	100/105			ATE 0 986 473 235	← 60		
	114					0 986 474 235	→ 60		
						BSY, 0 204 102 914	← 60		
						FDO, 0 986 473 362			
						JUR 0 204 102 915	→ 60		
						0 986 474 362			
	108 CDI, D	11.95-09.03	60/72/75/			1 987 481 007		518	
	110 CDI, D		90/95/100/						
	112 CDI		105						
	113								
	114								
	108 CDI, D	11.95-09.03	60/72/75/			0 204 102 916	← 33		
	110 CDI, D		90/95/100/			0 986 473 360			
	112 CDI		105			0 204 102 917	→ 33		
	113					0 986 474 360			
	114								
	108 CDI	ABO 11.95-09.03	60/72/75/90			F 026 003 366		23,8	
	108 D	ABS 11.95-09.03	60/72/75/90			0 204 123 367		23,8	
	110 CDI	ABO 11.95-09.03	60/72/75/90			F 026 003 366		23,8	
	110 D	ABS 11.95-09.03	60/72/75/90			0 204 123 367		23,8	
	112 CDI	ABO 04.99-09.03	60/72/75/90			F 026 003 366		23,8	
		ABS 04.99-09.03	60/72/75/90			0 204 123 367		23,8	
	113	ABO 11.95-09.03	95/100			F 026 003 366		23,8	
		ABS 11.95-09.03	95/100			0 204 123 367		23,8	
	114	ABO 11.95-09.03	105			F 026 003 366		23,8	
		ABS 11.95-09.03	105			0 204 123 367		23,8	
	108 CDI, D	11.95-09.03	60/72/75/			0 204 125 556			
	110 CDI, D		90/95/100/						
	112 CDI		105						
	113								
	114								
	108 CDI, D	11.95-09.03	60/72/75/			0 986 486 053			
	110 CDI, D		90/95/100/						
	112 CDI		105						
	113								
	114								
	108 CDI, D	11.95-09.03	60/72/75/			0 986 486 544			
	110 CDI, D		90/95/100/						
	112 CDI		105						
	113								
	114								
	108 CDI, D	11.95-09.03	60/72/75/			0 204 131 322 ¹⁰			
	110 CDI, D		90/95/100/						
	112 CDI		105						
	113								
	114								





	108 CDI, D 110 CDI, D 112 CDI 113 114	11.95-09.03	60/72/75/ 90/95/100/ 105			1 987 477 199	1170
--	---	-------------	--------------------------------	--	--	---------------	------

	108 CDI 110 CDI 112 CDI	04.99-09.03	60/75/90	Fg.Nr. →280987 Fg.Nr. 280987→		0 265 220 491 ²⁶ 0 265 224 066 ¹³	
	113 114	11.95-09.03	95/105	Fg.Nr. →280987 Fg.Nr. 280988→		0 265 220 491 ²⁶ 0 265 224 066 ²⁶	

	108 CDI, D 110 CDI, D 112 CDI 113 114	11.95-09.03	60/72/75/ 90/95/100/ 105			0 265 006 214 ³ 0 265 006 215 ⁴	
--	---	-------------	--------------------------------	--	--	--	--

Vito [639 TON]



	109 CDI 111 CDI 115 CDI 119 120 CDI 122 123 126	10.03→	65/70 80/85/110/ 140	AA		1 987 481 006 1 987 481 006	498 498
		04.06→	150	AA		1 987 481 006	498
		10.03→	160/170			1 987 481 006	498
		09.07→	190	Fg.Nr. →342257	AA	1 987 481 006	498

	109 CDI 111 CDI 115 CDI 119 120 CDI	10.03→	65/70/80/ 85/110/ 140	Fg.Nr. →056377 Fg.Nr. 056378→		0 204 204 673 0 204 204 674 0 204 004 513 0 204 004 514	← 48 → 48 ← 48 → 48
		04.06→	150			0 204 004 513 0 204 004 514	← 48 → 48
		10.03→	160/170	Fg.Nr. →056377 Fg.Nr. 056378→		0 204 204 673 0 204 204 674 0 204 004 513 0 204 004 514	← 48 → 48 ← 48 → 48
		09.07→	190	Fg.Nr. →342257		0 204 004 513 0 204 004 514	← 48 → 48



	109 CDI 111 CDI 115 CDI 119 120 CDI 122 123 126	10.03→	65/70/80/ 85/110/ 140/150/ 160/170/ 190			1 987 481 001	328
--	--	--------	---	--	--	---------------	-----



		S							
◀ MERCEDES-BENZ Vito [639 TON]									
	109 CDI	10.03→	65/70/80/				0 204 004 515	← 38	
	111 CDI		85/110/				0 204 004 516	→ 38	
	115 CDI		140/150/						
	119		160/170/						
	120 CDI		190						
	122								
	123								
	126								
	109 CDI	10.03→	65/70/80/				0 204 123 643	23,8	
	111 CDI		85/110/						
	115 CDI		140/150/						
	119		160/170/						
	120 CDI		190						
	122								
	123								
	126								
	109 CDI	10.03→	65/70/80/				0 204 051 088		
	111 CDI		85/110/						
	115 CDI		140/150/						
	119		160/170/						
	120 CDI		190						
	122								
	123								
	126								
	109 CDI	10.03→	65/70/80/				1 987 482 025	→ 1152	
	111 CDI		85/110/				1 987 482 026	← 1285	
	115 CDI		140		LKR		1 987 477 197	2799	
	119				RKR		1 987 477 198	2432	
	120 CDI	04.06→	150				1 987 482 025	→ 1152	
							1 987 482 026	← 1285	
	122	10.03→	160/170				1 987 482 025	→ 1152	
	123						1 987 482 026	← 1285	
					LKR		1 987 477 197	2799	
					RKR		1 987 477 198	2432	
	126	09.07→	190				1 987 482 025	→ 1152	
							1 987 482 026	← 1285	
						AA,LLE	1 987 477 197	2799	
						AA,RLE	1 987 477 198	2432	
	109 CDI	10.03→	65/70	Fg.Nr. →195055			0 265 225 347 ²⁶		
				Fg.Nr. 195056→			0 265 235 168 ²⁶		
	111 CDI	10.03-10.06	80		AA		0 265 235 001 ²⁶		
				Fg.Nr. →195055	AA		0 265 225 347 ²⁶		
				Fg.Nr. 195056→	AA		0 265 235 168 ²⁶		
		11.06→	85	Fg.Nr. →195055			0 265 225 347 ²⁶		
				Fg.Nr. 195056→			0 265 235 168 ²⁶		
	115 CDI	10.03→	110		AA		0 265 235 001 ²⁶		
				Fg.Nr. →195055	AA		0 265 225 347 ²⁶		
				Fg.Nr. 195056→	AA		0 265 235 168 ²⁶		
	119	10.03→	140/150/				0 265 235 168 ²⁶		
	120 CDI		160/170						
	122								
	123								





	109 CDI	10.03→	65/70/80/	Fg.Nr. →195055	0 265 005 258	
	111 CDI		85/110/	Fg.Nr. 195056→	0 265 005 628	
	115 CDI		140/150/			
	119		160/170			
	120 CDI					
	122 123					

	109 CDI	10.03→	65/70/80/		0 265 005 429	
	111 CDI		85/110/			
	115 CDI		140/150/			
	119		160/170			
	120 CDI					
	122 123					

2t [T1]

	208 D	10.87-06.95	58-60/		1 987 476 392	470
	210		70-77			
	210 D					

	208 D	10.87-06.95	58-60/	Fg.Nr. VA→BM:730.403,404	EBR	0 986 471 979	← 44	
	210		70-77			0 986 471 980	→ 44	
	210 D				Fg.Nr. VA→BM:730.445,446	ZBR	0 986 473 981	↻ ← 44
							0 986 473 982	↻ → 44

	208 D	10.87-06.95	58-60/		1 987 476 077 ¹	420
	210		70-77			
	210 D					

	208 D	10.87-06.95	58-60/		0 986 475 023	↔ 15
	210		70-77			
	210 D					

	207 D	ABS 01.88-01.89	53		SA	0 986 480 915	25
	208 D	10.88-06.95	58-60	Fg.Nr. →649390	ATE	0 986 480 059	23,8
				Fg.Nr. 649391→	ATE	0 986 480 062	25,4
		ABS 10.88-06.95	58-60		SA	0 986 480 915	25
	209 D	ABS 01.88-01.89	65		SA	0 986 480 915	25
	210	10.87-06.95	70-77	Fg.Nr. →649390	ATE	0 986 480 059	23,8
	210 D			Fg.Nr. 649391→	ATE	0 986 480 062	25,4
			ABS 01.88-06.95	70-77		SA	0 986 480 915

	208 D	10.87-06.95	58-60/	Fg.Nr. 231605→499999	RLE	0 986 486 056	
	210		70-77	Fg.Nr. 232363→499999	LLE	0 986 486 056	
				Fg.Nr. 547855→		0 986 486 056	
210 D	10.88-06.95	70-72			0 986 486 056		

	208 D	10.87-06.95	58-60/		0 986 486 547	
	210		70-77			





◀ MERCEDES-BENZ 2t [T1]

	208 D	10.87-06.95	58-60/	PEO	1 987 477 211	1806	
	210		70-77	MBB	1 987 477 118	→ 1862	
	210 D				1 987 477 119	← 1862	
					MI,R33	1 987 477 209	1130
					MI,R37	1 987 477 210	1480
					30R,MI	1 987 477 208	830

	207 D	01.88-06.95	53/58-60		0 265 105 022 ¹⁶	
	208 D					
	209 D	01.88-01.89	65	EFV	0 265 105 022 ¹⁶	
	210, D	01.88-06.95	70-77		0 265 105 022 ¹⁶	

	207 D	01.88-06.95	53/58-60/		0 332 002 171 ²³	
	208 D		65/70-77			
	209 D					
	210, D					

	207 D	01.88-06.95	53/58-60/		0 265 001 126 ³	
	208 D		65/70-77			
	209 D					
	210, D					

3t [T1]



	308 D	10.87-06.95	58-60/		1 987 476 392	470
	310		70-77			
	310 D					

	308 D	10.87-06.95	58-60/	Fg.Nr. VA-BM:→730.404,447	EBR	0 986 471 979	← 44	
	310		70-77			0 986 471 980	→ 44	
	310 D				Fg.Nr. VA-BM:→730.446,448	ZBR	0 986 473 981	↻ ← 44
							0 986 473 982	↻ → 44



	308 D	10.87-06.95	58-60/		1 987 476 077 ¹	420
	310		70-77			
	310 D					

	308 D	10.87-06.95	58-60/		0 986 475 023	↔ 15
	310		70-77			
	310 D					



	307 D	ABS	01.88-01.89	53		SA	0 986 480 915	25	
	308 D		10.88-06.95	58-60	Fg.Nr. →625656	BUS	ATE	0 986 480 059	23,8
					Fg.Nr. 625657→	BUS	ATE	0 986 480 062	25,4
					Fg.Nr. →649390		ATE	0 986 480 059	23,8
					Fg.Nr. 649391→		ATE	0 986 480 062	25,4
		ABS	10.88-06.95	58-60			SA	0 986 480 915	25
	309 D	ABS	01.88-01.89	65			SA	0 986 480 915	25
	310		10.87-06.95	70-77	Fg.Nr. →625656	BUS	ATE	0 986 480 059	23,8
					Fg.Nr. 625657→	BUS	ATE	0 986 480 062	25,4
					Fg.Nr. →649390		ATE	0 986 480 059	23,8
					Fg.Nr. 649391→		ATE	0 986 480 062	25,4
		ABS	01.88-06.95	70-77			SA	0 986 480 915	25
	310 D		10.88-06.95	70-72	Fg.Nr. →649390		ATE	0 986 480 059	23,8
					Fg.Nr. 649391→		ATE	0 986 480 062	25,4
		ABS	10.88-06.95	70-72			SA	0 986 480 915	25

		S							
	308 D 310 310 D	10.87-06.95	58-60/ 70-77		G10 G12		0 986 486 021 0 986 486 056		
	308 D 310 310 D	10.87-06.95	58-60/ 70-77				0 986 486 547		
	308 D 310 310 D	10.87-06.95	58-60/ 70-77		PEO MBB MI,R33 MI,R37 30R,MI		1 987 477 211 1 987 477 118 1 987 477 119 1 987 477 209 1 987 477 210 1 987 477 208	1806 → 1862 ← 1862 1130 1480 830	
	307 D 308 D 309 D 310, D	01.88-06.95	53/58-60/ 65/70-77				0 265 105 022 ¹⁶		
	307 D 308 D 309 D 310, D	01.88-06.95	53/58-60/ 65/70-77				0 332 002 171 ²³		
4t [T1]									
	408 D 410 410 D	10.87-06.95	58-60/ 70-77				1 987 476 392	470	
	408 D 410 410 D	10.87-06.95	58-60/ 70-77	Fg.Nr. VA: A 025461→ Fg.Nr. VA:→A 025460	ATE, JUR EBR		0 986 474 956 0 986 471 979 0 986 471 980	☺ → 44 ← 44 → 44	
	408 D 410 410 D	10.87-06.95	58-60/ 70-77				1 987 476 077 ¹	420	
	408 D 410 410 D	10.87-06.95	58-60/ 70-77				0 986 475 042	↔ 22,19	
	408 D 410 410 D	10.87-06.95	58-60/ 70-77	Fg.Nr. →598434 Fg.Nr. 598435→			0 986 480 060 0 986 480 917	25,4 26,99	
	408 D 410 410 D	10.87-06.95	58-60/ 70-77		G10 G12		0 986 486 021 0 986 486 056		
	408 D 410 410 D	10.87-06.95	58-60/ 70-77				0 986 486 547		



◀ MERCEDES-BENZ 4t [T1]									
	408 D	11.88-06.95	58-60/				1987	477 121	→ 1760
	410 D		70-72				1987	477 122	← 1760
	407 D	01.88-01.89	53			EFV	0 265	105 022 ¹⁶	
						Fg.Nr. →974114	0 265	105 013 ¹⁶	
	408 D	11.88-04.89	58-60			Fg.Nr. →974114	0 265	105 013 ¹⁶	
		11.88-06.92	58-60			EFV	0 265	105 022 ¹⁶	
		11.88-06.95	58-60			EFV	0 265	105 022 ¹⁶	
	409 D	01.88-01.89	65			EFV	0 265	105 022 ¹⁶	
						Fg.Nr. →974114	0 265	105 013 ¹⁶	
	410	01.88-04.89	70-77			Fg.Nr. →974114	0 265	105 013 ¹⁶	
		01.88-06.92	70-77			EFV	0 265	105 022 ¹⁶	
		01.88-06.95	70-77			EFV	0 265	105 022 ¹⁶	
410 D	11.88-04.89	70-72			Fg.Nr. →974114	0 265	105 013 ¹⁶		
	11.88-06.92	70-72			EFV	0 265	105 022 ¹⁶		
	11.88-06.95	70-72			EFV	0 265	105 022 ¹⁶		
	11.88-06.95	70-72			EFV	0 265	105 022 ¹⁶		
	407 D	01.88-06.95	53/58-60/				0 332	002 171 ²³	
	408 D		65/70-77						
	409 D								
	410, D								
5t									
	507 D	04.86-02.01	53/58/	Vordera. →A 025668	EBR	ATE	0 986	471 979	← 44
	508 D		70-77				0 986	473 979	↻
	510						0 986	471 980	→ 44
							0 986	473 980	↻
				Vordera. A 025669→		ATE, JUR	0 986	474 956	↻ → 44
	507 D	04.86-02.01	53/58/				1987	476 391 ¹	475
	508 D		70-77						
	510								
	507 D	01.88-04.89	53				0 332	002 171 ²³	
	508 D	01.88-02.01	58/70-77				0 332	002 171 ²³	
	510	01.90-02.01	58/70-77			SFZ	0 332	205 004 ²³	
6t									
	609 D	04.86-02.01	66				1987	476 391 ¹	475
	609 D	04.86-09.01	63/66/77				1987	477 125	→ 1023
	611 D						1987	477 126	← 1111

		S								
	609 D	12.89-09.01	63/66						0 265 105 017 ¹⁶	
	609 D 611 D	04.86-09.01	63/66/77				TW		0 332 002 286 ²³ 0 332 002 288 ²³	
7t										
	709 D 711 D 714 D	04.86-02.01	63/66/77/ 85/103						1 987 476 392	470
	709 D 711 D 714 D	04.86-02.01	63/66/77/ 85/103						1 987 476 391 ¹	475
	709 D 711 D 714 D	04.86-02.01	63/66/77/ 85/103						0 986 480 567	33
	709 D 711 D 714 D	04.86-02.01	63/66/77/ 85/103						1 987 477 125 1 987 477 126	→ 1023 ← 1111
	709 D 711 D 714 D	12.89-02.01	63/66/77/ 85/103						0 265 105 017 ¹⁶	
	709 D 711 D 714 D	04.86-02.01	63/66/77/ 85/103				TW		0 332 002 286 ²³ 0 332 002 288 ²³	
8t										
	809 D 811 D 814 D, DA	04.86-02.01	63/66/77/ 85/100				ALE		1 987 476 392	470
	809 D 811 D 814 D, DA	04.86-02.01	63/66/77/ 85/100				AA AA		1 987 476 077 ¹ 1 987 476 391 ¹	420 475
	809 D 811 D 814 D	04.86-02.01	63/66/77/ 85/100						0 986 480 567	33





◀ MERCEDES-BENZ 8t

	809 D	04.86-02.01	63/66/77/	1987 477 125	→ 1023
	811 D		85/100	1987 477 126	← 1111
	814 D, DA				

	809 D	12.89-02.01	63/66/77/	0265 105 017 ¹⁶	
	811 D		85/100		
	814 D				

	809 D	04.86-02.01	63/66/77/	TW	0332 002 286 ²³
	811 D		85/100		0332 002 288 ²³
	814 D, DA				

8t [LK]



	811	01.92-12.99	77/95/100/	0265 150 320 ¹⁸	
	814, F, L, LO, O		103/116/		
	817, F, L, LO		125		

9t [LK]



	914	01.92-02.93	100	0265 150 320 ¹⁸	

11t [LK]



	1114, AK, L, O	01.92-12.99	95/100/	0265 150 320 ¹⁸		
	1117, A		116/125			
	1117 A	01.92-12.92	125	0265 150 320 ¹⁸		
				EFV	0265 150 320 ¹⁸	
		03.94-12.99	125	0265 150 320 ¹⁸		
	1117 A Export	01.92-02.93	125	0265 150 320 ¹⁸		
	1117 Export			EFV	0265 150 320 ¹⁸	
	1117 L	01.92-12.92	125	0265 150 320 ¹⁸		
		03.94-12.99	125	0265 150 320 ¹⁸		
	1117 LO	03.94-12.99	125	0265 150 320 ¹⁸		
	1120, AF, F, L	01.92-02.93	148-150	0265 150 320 ¹⁸		

12t [MK]



	1222	01.92-08.94	165/195	0265 150 320 ¹⁸	
	1222 A				
	1226 AF				

13t [LK]



	1314, AK	01.92-02.01	95/100/	0265 150 320 ¹⁸	
	1317, AK, L		116/125/		
	1324, L		177		



14t [MK]



CPU	1417, A	01.92-09.93	125/129/	0 265 150 320 ¹⁸
	1420, L		155/160/	
	1422, F, L		165/	
	1426 LS, S		191-195	
	1427 F	02.93-09.96	200	

15t [LK]



CPU	1514, L	01.92-02.01	95/100/	0 265 150 320 ¹⁸
	1517, L		116/125/	
	1524, L		170	

16t [MK]



CPU	1624	02.93-08.94	180	0 265 150 320 ¹⁸
-----	------	-------------	-----	-----------------------------

17t [LK]



CPU	1724	01.92-02.01	170	0 265 150 320 ¹⁸
-----	------	-------------	-----	-----------------------------

17t [MK]



CPU	1717, AK, L	01.92-02.01	129/150/	0 265 150 320 ¹⁸
	1720, L		155/160/	
	1722, AK, L		165/195/	
	1726, AK, L		243-249	
	1733, L			

17t [SK]



CPU	1729	01.92-08.94	218	0 265 150 320 ¹⁸
	1729 L			

18t [MK]



CPU	1820 L	01.92→	155/200/	0 265 150 320 ¹⁸
	1827, L		230/250	
	1831, L			
	1834, L			





18t [SK]



CPU	1831 AK	01.92-02.01	230/280/	0 265 150 320 ¹⁸
	1838, AK, L		320	
	1840 LS			
	1844, L			

19t [SK]



CPU	1929, L	01.92-08.94	213/250/	0 265 150 320 ¹⁸
	1935, A, AK, K		269/	
	1948		353-362	

20t [SK]



CPU	2024 A	01.92-02.01	180/200/	0 265 150 320 ¹⁸
	2027 AK		280/370	
	2038			
	2050			
	2055			



23t [MK]



CPU	2327	02.93-09.96	200	0 265 150 320 ¹⁸
-----	------	-------------	-----	-----------------------------

24t [MK]



CPU	2420, L	01.92-09.96	155/165/	0 265 150 320 ¹⁸
	2422, L		195/200/	
	2426, L		243-249	
	2427 L			
	2433, L			

24t [SK]



CPU	2429, L	01.92-08.94	213/250/	0 265 150 320 ¹⁸
	2435, K, L		260-269/	
	2448, L		353-362	

25t [MK]



CPU	2527 B	01.92→	200/230/	0 265 150 320 ¹⁸
	2531, L		250	
	2534, L			



25t [SK]



CPU	2538, L	01.92-08.96	280/320/	0 265 150 320 ¹⁸
	2544		370	
	2550			

26t [SK]



CPU	2629, A	01.92-09.96	213/218/	0 265 150 320 ¹⁸
	2631, A		230/250/	
	2635, A		260-269/	
	2638, A		280/320/	
	2644		353-362/	
	2648		370	
	2650			

30t [SK]



CPU	3050	01.92-02.01	370	0 265 150 320 ¹⁸

32t [SK]



CPU	3229	01.92-02.01	213/250/	0 265 150 320 ¹⁸
	3233		260/280	
	3234			
	3235			
	3238			

35t [SK]



CPU	3535, AK	01.92-09.96	266/269/	0 265 150 320 ¹⁸
	3538, A		280/320/	
	3544 S		362/370/	
	3548 S		390	
	3550 S			
	3553, L			

44t [SK]



CPU	4435 K	01.92-02.01	260	0 265 150 320 ¹⁸





MITSUBISHI

Canter 35 [FE]



	3C 14	01.05→	104	0 204 031 141 ¹⁰
	3S 11	01.05→	81/92	0 204 031 142
	3S 13			

Canter 55 [FE]



	5S 13	01.05→	92	0 204 031 141 ¹⁰
--	-------	--------	----	-----------------------------

Canter 65 [FE]



	6C 14	01.05→	104/107	0 204 031 141 ¹⁰
	6C 15			
	6C 18	08.06→	132	0 204 031 287 ¹⁰

Canter 75 [FE]



	7C 15	04.06→	107	0 204 031 141 ¹⁰
	7C 18	08.06→	132	0 204 031 141 ¹⁰
				0 204 031 287 ¹⁰

Colt L300



	2.5 D	03.94→	53	1987 476 737 ¹	270
--	-------	--------	----	---------------------------	-----



















	2.5 D	01.90→	53	0986 475 718	← 20,6
				0986 475 719	→ 20,6

L 200



	2.5 D Turbo	08.97-12.03	64	0986 473 048	← 57
				0986 473 153	← 42,73
				0986 474 048	→ 57
				0986 474 153	→ 42,73



		S							
									
 2.5 D Turbo		08.97-12.03	64				0 986 475 921	→ 22,19	
							0 986 475 922	← 22,19	
L 200 [K0-K3]									
									
 2.0 4WD		11.86-05.94	65				1 987 481 095 ²	221	
2.4 i 4WD		06.94-11.97	82				1 987 481 011	190	
							1 987 481 011 ¹	190	
2.5 D Turbo 4WD		12.87-03.01	54/73				1 987 476 193 ²		
2.5 D 4WD							1 987 476 502 ¹	210	
2.6		11.89-05.95	76/110				1 987 481 095 ²	221	
3.0 i V6									
 1.6		11.86-03.95	48				0 986 473 046	☺ ← 57	
							0 986 474 046	☺ → 576	
2.0 2WD		11.86-05.95	65/82				0 986 473 046	☺ ← 57	
							0 986 474 046	☺ → 576	
2.0 4WD		11.86-05.94	65/82				0 986 473 048	☺ ← 57	
							0 986 474 048	☺ → 57	
2.4 i 2WD		06.90-11.97	65/82				0 986 473 046	☺ ← 57	
							0 986 474 046	☺ → 576	
2.4 i 4WD		06.94-11.97	65/82				0 986 473 048	☺ ← 57	
							0 986 474 048	☺ → 57	
2.5 D Turbo 4WD, D 4WD		12.87-03.01	54/73/76/				0 986 473 048	☺ ← 57	
2.6			110				0 986 474 048	☺ → 57	
3.0 i V6									
									
 1.6		11.86-03.95	48				0 986 475 919	→ 23,8	
							0 986 475 920	← 23,8	
2.0 2WD		11.86-05.95	65/82				0 986 475 919	→ 23,8	
							0 986 475 920	← 23,8	
2.0 4WD		11.86-05.94	65/82				0 986 475 921	→ 22,19	
							0 986 475 922	← 22,19	
2.4 i 2WD		06.90-11.97	65/82				0 986 475 919	→ 23,8	
							0 986 475 920	← 23,8	
2.4 i 4WD		06.94-11.97	65/82				0 986 475 921	→ 22,19	
							0 986 475 922	← 22,19	
2.5 D Turbo 4WD		12.87-03.01	54/73				0 986 475 921	→ 22,19	
2.5 D 4WD							0 986 475 922	← 22,19	
2.6		11.89-05.95	76				0 986 475 919	→ 23,8	
							0 986 475 920	← 23,8	
3.0 i V6		06.90-05.91	110				0 986 475 921	→ 22,19	
							0 986 475 922	← 22,19	
									
 2.0 2WD		11.88-10.89	65		RLE		0 986 480 728	23,8	
		11.89-05.95	65		RLE		0 986 480 734	23,8	
2.0 4WD		11.86-10.89	65		RLE		0 986 480 728	23,8	
		11.89-05.94	65				0 986 480 734	23,8	
2.4 i 2WD, i 4WD		06.90-11.97	73/82				0 986 480 734	23,8	
2.5 D Turbo 4WD		11.92-03.01	73/82				0 986 480 734	23,8	
2.5 D 2WD		11.88-10.89	54				0 986 480 728	23,8	
		11.89-05.96	54				0 986 480 734	23,8	





	◀ MITSUBISHI L 200 [K0-K3]						
	2.5 D 4WD	12.87-10.92	54		0986 480 734	23,8	
	3.0 i V6	06.90-05.91	110		0986 480 734	23,8	
	1.6	11.86-05.95	48/65		1987 482 066	← 1888	
	2.0 2WD				1987 482 067	→ 2350	
	2.4 i 2WD	06.90-11.97	82	FLR	1987 482 066	← 1888	
					1987 482 067	→ 2350	

L 200 [K6/K7]

	2.0 i 16V	01.96-06.01	90	AU	1987 476 194	285	
				IN	1987 476 502	210	
	2.4 i 4WD	01.96-05.99	97		1987 481 010	182	
					1987 481 010 ²	182	
					1987 481 013 ¹	245	
	2.5 D Turbo Interc. 2WD	01.96→	74-85	AU	1987 476 194	285	
				IN	1987 476 502	210	
	2.5 D Turbo Interc. 4WD	01.96-05.96	73-85		1987 481 010	182	
					1987 481 010 ²	182	
					1987 481 013 ¹	245	
		06.03→	73-85		1987 481 010 ²	182	
					1987 481 011 ¹	190	
	2.5 D 2WD	06.95-06.01	55-64	AU	1987 476 194	285	
				IN	1987 476 502	210	
	2.5 D	01.96-05.96	64		1987 481 010	182	
	2.5 D 4WD				1987 481 010 ²	182	
					1987 481 013 ¹	245	
	2.8 D	06.95→	92		1987 476 194	285	
	2.8 D 4WD	11.96→	92		1987 481 010	182	

	2.4 i 4WD	ABO 01.96-07.99	97		0986 473 169	← 60,21	
					0986 474 169	→ 60,21	
		ABS 01.96→	97		0986 473 153	← 42,73	
					0986 474 153	→ 42,73	
	2.5 D	ABO 01.96-05.00	64/73-85		0986 473 169	← 60,21	
	2.5 D Turbo Interc. 4WD				0986 474 169	→ 60,21	
	2.5 D 4WD	ABS 01.96→	64/73-85		0986 473 153	← 42,73	
					0986 474 153	→ 42,73	
	2.8 D 4WD	11.96→	92		0986 473 169	← 60,21	
					0986 474 169	→ 60,21	

	2.0 i 16V	06.95-01.00	55-64/		0986 475 919	→ 23,8	
	2.4 i 4WD		73-85/90/		0986 475 920	← 23,8	
	2.5 D, D Turbo Interc. 2WD		97				
	2.5 D Turbo Interc. 4WD						
	2.5 D 2WD, D 4WD						
	2.8 D	06.95→	92		0986 475 919	→ 23,8	
	2.8 D 4WD				0986 475 920	← 23,8	

	2.0 i 16V	01.96-06.98	90		0986 480 861		
	2.4 i 4WD	ABO 01.96-05.02	97		0986 480 861		
	2.5 D, D Turbo Interc. 4WD	ABO 06.95-06.98	55-64/		0986 480 861		
	2.5 D 2WD, D 4WD		73-85				
	2.8 D, D 4WD	06.95→	92		0986 480 861		



	2.5 D 2WD	ABO 06.95-06.98	55-64	F 01G 09B 02X	
	2.8 D	ABO 06.95→	92	F 01G 09B 02X	
	2.4 i 4WD	01.96-06.01	97	1 987 482 068	← 1996
				1 987 482 069	→ 1993
		07.01→	97	1 987 482 068	← 1996
	2.5 D Turbo Interc. 4WD	01.96→	73-85/92	1 987 482 068	← 1996
	2.8 D 4WD			1 987 482 069	→ 1993

L 300 [P]

	2.5 D Turbo 4WD Wagon	12.87-05.96	62-64	1 987 476 193 ²	
				1 987 476 502 ¹	210
	2.5 D Turbo 4WD Wagon	12.87-05.96	62-64	0 986 473 048	← 57
				0 986 474 048	→ 57

	2.5 D Turbo 4WD Wagon	12.87-05.96	62-64	0 986 475 718	← 20,6
				0 986 475 719	→ 20,6

	2.5 D Turbo 4WD Wagon	12.87-05.96	62-64	0 986 480 729	23,8

L 300 Truck [L]

	1.6	11.86-05.94	48-51/52	1 987 476 502	210
	2.5 D				
	1.6	11.86-05.94	48-51/52	1 987 481 031	355
	2.5 D				
	1.6	11.86-05.94	48-51/52	0 986 475 718	← 20,6
	2.5 D			0 986 475 719	→ 20,6

L 300 Truck [P]

	2.0 i 16V	06.94-12.01	64/65/85	0 986 475 921	→ 22,19
	2.0 16V			0 986 475 922	← 22,19
	2.5 D Turbo				





L 300 Van [L]

	1.6 2WD 1.6 4WD 2.0 4WD	06.86-10.86	48		1987 476 737	270
		01.85-10.86	75		1987 481 031	355
	1.6 2WD 1.6 4WD 2.0 4WD	06.86-10.86	48		1987 481 031	355
		01.85-10.86	75		1987 481 011	190
	1.6 2WD 1.6 4WD 2.0 4WD	01.85-10.86	48/75		0986 475 718 0986 475 719	← 20,6 → 20,6

L 300 Van [P]

	1.6 2WD 2.0 i 2WD 2.0 2WD 2.0 4WD	11.86-12.01	48-51/65/ 66		1987 476 345 ²	220
		11.86-10.92	65		1987 476 193 ²	
					1987 476 502 ¹	210
	2.4 i 2WD	11.91-05.94	82		1987 476 345 ²	220
	2.4 i 4WD	11.86-05.94	62-64/80/ 82		1987 476 193 ²	
					1987 476 502 ¹	210
	2.5 D Turbo 4WD	11.88-12.01	62-64/80/ 82		1987 476 193 ²	
					1987 476 502 ¹	210
	2.5 D 2WD	11.86-12.00	51		1987 476 345 ²	220
	1.6 2WD 2.0 i 2WD, 2WD 2.0 4WD	11.86-12.01	48-51/65/ 66		0986 473 046 0986 474 046	← 57 → 576
		11.86-10.92	65		0986 473 048 0986 474 048	← 57 → 57
	2.4 i 2WD	11.91-05.94	82		0986 473 046 0986 474 046	← 57 → 576
	2.4 i 4WD	11.86-05.94	62-64/80/ 82		0986 473 048 0986 474 048	← 57 → 57
	2.5 D Turbo 4WD	11.88-12.01	62-64/80/ 82		0986 473 048 0986 474 048	← 57 → 57
	2.5 D 2WD	11.86-12.00	51		0986 473 046 0986 474 046	← 57 → 576
	1.6 2WD 2.0 i 2WD, 2WD 2.4 i 2WD 2.5 D 2WD	11.86-12.01	48-51/65/ 66/82		1987 481 031	355
	1.6 2WD 2.0 i 2WD, 2WD, 4WD 2.4 i 2WD, i 4WD 2.5 D Turbo 4WD, D 2WD	11.86-12.01	48-51/ 62-64/65/ 66/80/82		0986 475 718 0986 475 719	← 20,6 → 20,6





	1.6 2WD	11.86-12.01	48-51/65/		FLR,LLE	0 986 480 729	23,8	
	2.0 i 2WD, 2WD		66					
	2.0 4WD	11.86-05.94	62-64/65/			0 986 480 729	23,8	
	2.4 i 2WD, i 4WD		80/82					
	2.5 D Turbo 4WD	11.88-12.01	62-64/65/80/82			0 986 480 729	23,8	
	2.5 D 2WD	11.86-12.00	51		LLE	0 986 480 729	23,8	

L 300 Wagon [L]

	2.0 4WD	01.85-10.86	75			1 987 481 031	355	

	2.0 4WD	01.85-10.86	75			1 987 481 011	190	

	2.0 4WD	01.85-10.86	75			0 986 475 718	← 20,6	
						0 986 475 719	→ 20,6	

L 300 Wagon [P]

	1.6	11.86-05.94	48-51			1 987 476 345 ²	220	
	2.0 i 2WD	06.96-08.97	83			1 987 476 345 ²	220	
	2.0 2WD	11.86-06.95	65/66			1 987 476 345 ²	220	
	2.0 4WD	11.86-06.93	65			1 987 476 193 ²		
						1 987 476 502 ¹	210	
	2.4 i 2WD	11.90-05.96	82			1 987 476 345 ²	220	
	2.4 i 4WD	11.86-06.95	80/82			1 987 476 193 ²		
						1 987 476 502 ¹	210	
	2.5 D 2WD long, D 2WD short	11.86-12.00	51			1 987 476 345 ²	220	

	1.6	11.86-05.94	48-51			0 986 473 046	← 57	
						0 986 474 046	→ 576	
	2.0 i 2WD	06.96-08.97	83			0 986 473 046	← 57	
						0 986 474 046	→ 576	
	2.0 2WD	11.86-06.95	65/66			0 986 473 046	← 57	
						0 986 474 046	→ 576	
	2.0 4WD	11.86-06.93	65			0 986 473 048	← 57	
						0 986 474 048	→ 57	
	2.4 i 2WD	11.90-05.96	82			0 986 473 046	← 57	
						0 986 474 046	→ 576	
	2.4 i 4WD	11.86-06.95	80/82			0 986 473 048	← 57	
						0 986 474 048	→ 57	
	2.5 D 2WD long, D 2WD short	11.86-12.00	51			0 986 473 046	← 57	
						0 986 474 046	→ 576	





◀ MITSUBISHI L 300 Wagon [P]



	1.4	11.86-12.00	48-51/52/		1987	481 031	355
	1.6		65/66/82/				
	2.0 i 2WD, 2WD		83				
	2.4 i 2WD						
	2.5 D 2WD long, D 2WD short						

	1.6	11.86-12.00	48-51/65/		0986	475 718	← 20,6
	2.0 i 2WD, 2WD, 4WD		66/80/82/		0986	475 719	→ 20,6
	2.4 i 2WD, i 4WD		83				
	2.5 D 2WD long, D 2WD short						



	1.6	11.86-05.94	48-51		0986	480 729	23,8
	2.0 4WD	11.86-06.93	65	LLE	0986	480 729	23,8
	2.4 i 2WD, i 4WD	11.86-05.96	80/82		0986	480 729	23,8
	2.5 D 2WD long	11.86-12.00	51	LLE	0986	480 729	23,8
	2.5 D 2WD short	11.86-08.97	51		0986	480 729	23,8

L 400



	2.4 i	12.94-03.01	64/97		1987	476 193²	
	2.5 D Turbo 4WD				1987	476 502¹	210

	2.0 i	ABO	12.94-03.01	83-85		0986	473 169	← 60,21
						0986	474 169	→ 60,21
	2.4 i		12.94-03.01	97		0986	473 153	← 42,73
						0986	474 153	→ 42,73
	2.5 D Turbo 2WD	ABO	12.94-03.01	64		0986	473 169	← 60,21
						0986	474 169	→ 60,21
	2.5 D Turbo 4WD		12.94-03.01	64		0986	473 153	← 42,73
						0986	474 153	→ 42,73



	2.0 i	12.94-03.01	83-85	FKR	0986	475 921	↔ 22,19
				FLR	0986	475 919	↔ 23,8
	2.4 i	12.94-03.01	97		0986	475 921	↔ 22,19
	2.5 D Turbo 2WD	12.94-03.01	64	FKR	0986	475 921	↔ 22,19
				FLR	0986	475 919	↔ 23,8
	2.5 D Turbo 4WD	12.94-03.01	64		0986	475 921	↔ 22,19

NISSAN

Cabstar [F23]



	2.0	07.92-05.94	66		0986	475 669	↔ 25,4
	2.5 D	07.92-05.96	59	OZB	0986	475 669	↔ 25,4



Cabstar [F24]



	2.5 D Turbo	09.06→	81/96/110	LLE	0 204 051 743	26,99
	3.0 D Turbo			RLE	0 204 051 742	26,99
	2.5 D Turbo	09.06-03.09	96	4T5,RLE	0 204 051 528	
		09.06→	81		0 204 051 528	
			96	32T,3T5	0 204 051 528	
				4T5,LLE	0 204 051 539	
		04.09→	96	4T5,RLE	0 204 051 539	
	3.0 D Turbo	09.06-03.09	110	4T5,LLE,	0 204 051 528	
				MG5		
					4T5,LLE,	0 204 051 539
				MG6		
			4T5,RLE	0 204 051 528		
	09.06→	110	3T5	0 204 051 528		
	04.09→	110	4T5	0 204 051 539		

Hardbody [D22-244]



	3.0 TD	05.02→	105		F 01G 09E 010 ¹⁶	
	3.0 TD	05.02→	105	LAB	F 01G 09F 0EX ³	
				RAB	F 01G 09F 0EY ³	
					F 01G 09F 0FK ⁴	
	3.2 D	05.02→	76		F 01G 09F 0EY ³	
LAB				F 01G 09F 0EX ³		
				F 01G 09F 0FL ⁴		
			RAB	F 01G 09F 0EY ³		
				F 01G 09F 0FK ⁴		

Hardbody [D22-244; NP300]



	2.5 D Turbo	ABS	01.06-06.08	98		F 01G 061 0LP	
	2.5 D Turbo		01.06-06.08	98	LAB	F 01G 09F 0D9 ³	
					RAB	F 01G 09F 0A5 ³	

Hardbody [NP300]



	2.5 D Turbo 4x4	ABS	05.08→	98		F 01G 061 0LP	
	2.5 D Turbo 4x4		05.08→	98		F 01G 09D 03N ¹¹	





◀ NISSAN Hardbody [NP300]

	2.5 D Turbo 4x4	05.08→	98	LAB	F 01G 09F 0EX ³	
					F 01G 09F 0FJ ⁴	
	RAB			F 01G 09F 0EY ³		
				F 01G 09F 0FK ⁴		

Interstar [X70]



	1.9 D Turbo dCi 80	ABO 07.02→	59-60/66	ANO,AS2	1 987 481 151	538
	2.2 D Turbo dCi 90			ANU,AS2	1 987 481 150	507
		ABS 07.02-11.03	59-60/66	ANO,AS2	1 987 481 151	538
				ANU,AS2	1 987 481 150	507
	2.5 D Turbo dCi 100	ABO 11.03→	73-74	ANO,AS2	1 987 481 151	538
				ANU,AS2	1 987 481 150	507
	2.5 D Turbo dCi 120	ABO 07.02→	84-88	ANO,AS2	1 987 481 151	538
				ANU,AS2	1 987 481 150	507
		ABS 07.02-11.03	84-88	ANO,AS2	1 987 481 151	538
				ANU,AS2	1 987 481 150	507
	3.0 D Turbo dCi 140	ABO 11.03→	99-100	ANO,AS2	1 987 481 151	538
				ANU,AS2	1 987 481 150	507

	1.9 D Turbo dCi 80	07.02-11.03	59-60/66		0 204 103 969	← 45
	2.2 D Turbo dCi 90				0 204 103 970	→ 45
		ABO 12.03→	59-60/66		0 204 103 969	← 45
					0 204 103 970	→ 45
	2.5 D Turbo dCi 100	ABO 11.03→	73-74		0 204 103 969	← 45
					0 204 103 970	→ 45
	2.5 D Turbo dCi 120	07.02-11.03	84-88		0 204 103 969	← 45
					0 204 103 970	→ 45
		ABO 12.03→	84-88		0 204 103 969	← 45
					0 204 103 970	→ 45
	3.0 D Turbo dCi 140	ABO 11.03→	99-100		0 204 103 969	← 45
					0 204 103 970	→ 45



	1.9 D Turbo dCi 80	ABO 07.02→	59-60/66/73-74/84-88/99-100	SE	1 987 481 152	358
	2.2 D Turbo dCi 90	ABS 07.02→	59-60/66/73-74/84-88/99-100	SE	1 987 481 152	358
	2.5 D Turbo dCi 100	ABO 07.02→	59-60/66/73-74/84-88/99-100	SE	1 987 481 152	358
	2.5 D Turbo dCi 120	ABS 07.02→	59-60/66/73-74/84-88/99-100	SE	1 987 481 152	358
	3.0 D Turbo dCi 140	ABO 11.03→	59-60/66/73-74/84-88/99-100	SE	1 987 481 152	358
		ABS 11.03→	59-60/66/73-74/84-88/99-100	SE	1 987 481 152	358

	1.9 D Turbo dCi 80	07.02→	59-60/66/73-74/		0 204 004 320	← 42
	2.2 D Turbo dCi 90		84-88/99-100		0 986 473 260	
	2.5 D Turbo dCi 100, D Turbo dCi 120				0 204 004 321	→ 42
	3.0 D Turbo dCi 140				0 986 474 260	



	1.9 D Turbo dCi 80	07.02→	59-60/66/73-74/		1 987 482 012	1175
	2.2 D Turbo dCi 90		84-88/99-100	FKR	1 987 482 013	1420
	2.5 D Turbo dCi 100, D Turbo dCi 120			FLR	1 987 477 261	1737
	3.0 D Turbo dCi 140					



Kubistar [X76]



	1.2 i 8V, i 16V	07.03→	40-42/44/48-50/	NON	1 987 477 632	← 1413
	1.4 i		55-56/59-62/		1 987 477 633	→ 1421
	1.5 D Turbo 60, D Turbo 70		70-71			
	1.5 D Turbo 80 1.6 i					

Pickup [D21]



	2.4 i 2WD	03.92-08.93	93		0 986 473 409	↔ 42,78
	2.4 i 4WD				0 986 474 409	↔ 42,78
	2.4 i	04.92-02.98	91-93		0 986 473 409	↔ 42,78
	2.4 i 4WD				0 986 474 409	↔ 42,78



	2.0	10.89-09.95	64/65		0 986 475 758	↔ 23,8
	2.4, i	10.88-02.98	74/91-93		0 986 475 758	↔ 23,8
	2.4 i 2WD	03.92-06.96	93		0 986 475 758	↔ 23,8
	2.4 i 4WD, 4WD	10.88-04.92	74		0 986 475 924	↔ 20,6
	2.5 D	10.88-02.98	59-63		0 986 475 758	↔ 23,8
	2.5 D 4WD	10.88-04.92	59-63		0 986 475 924	↔ 20,6
	2.7 D 2WD	10.89-06.96	62		0 986 475 758	↔ 23,8

Pickup [D22]



	2.5 dCi	ABO 02.08→	98		F 01G 062 087	
	2.4 i	ABS 11.01-01.08	98		F 01G 061 0LP	
	2.4 i 4WD	11.01-01.08	98		F 01G 061 0LP	
	2.5 D Turbo	ABO 01.07→	98		F 01G 061 0LH	
	2.5 dCi	ABS 11.01→	98		F 01G 061 0LP	
	2.5 D Turbo 4WD, dCi 4x4	11.01→	98		F 01G 061 0LP	
	2.4 i 4WD	11.01→	98		F 01G 09D 03N ¹¹	
	2.5 D Turbo 4WD					
	2.5 dCi 4x4					
	2.4 i	07.98-11.01	88	LAB	F 01G 09F 0A4 ³	
				RAB	F 01G 09F 0A5 ³	
		11.01-01.08	98	LAB	F 01G 09F 0BY ³	
				RAB	F 01G 09F 0BZ ³	
	2.4 i 4WD	02.98-11.01	88	LAB	F 01G 09F 0EX ³	
					F 01G 09F 0FJ ⁴	
		11.01-01.08	98	RAB	F 01G 09F 0FK ⁴	
				LAB	F 01G 09F 0FJ ⁴	
			RAB	F 01G 09F 0HK ⁴		
				F 01G 09F 0HR ³		





NISSAN Pickup [D22]

2.5 D Turbo	11.01-03.03	98	4-K,LAB	F 01G 09F 0J0 ⁴	
	11.01-09.03	98	LAB,NOR	F 01G 09F 0A4 ³	
	11.01-01.08	98	LAB,SA	F 01G 09F 0EX ³	
2.5 D Turbo 4WD			NOR,RAB	F 01G 09F 0A5 ³	
			RAB,SA	F 01G 09F 0EY ³	
			4-K,RAB	F 01G 09F 0HV ⁴	
	04.03-01.08	98	4-K,LAB	F 01G 09F 0HU ⁴	
	10.03-01.08	98	LAB,NOR	F 01G 09F 0D9 ³	
	2.5 D Turbo 4WD	05.98-11.01	76	LAB	F 01G 09F 0EX ³
RAB				F 01G 09F 0FK ⁴	
11.01-01.08		98	LAB	F 01G 09F 0EX ³	
				F 01G 09F 0FJ ⁴	
				F 01G 09F 0FL ⁴	
RAB	F 01G 09F 0EY ³				
RAB	F 01G 09F 0FK ⁴				
2.5 D	07.98-11.01	61	LAB	F 01G 09F 0A4 ³	
2.5 D 4WD			RAB	F 01G 09F 0A5 ³	
2.5 dCi	02.08→	98	LAB,NOR	F 01G 09F 0D9 ³	
			LAB,SA	F 01G 09F 0EX ³	
			NOR,RAB	F 01G 09F 0A5 ³	
			RAB,SA	F 01G 09F 0EY ³	
2.5 dCi 4x4	02.08→	98	LAB	F 01G 09F 0EX ³	
				F 01G 09F 0FJ ⁴	
				F 01G 09F 0FL ⁴	
			RAB	F 01G 09F 0EY ³	
			RAB	F 01G 09F 0FK ⁴	

Primastar [X83]

	1.9 dCi 80, dCi 100	07.02→	59-60/66/74/84-85/		1987 476 700	380	
	2.0 dCi 90, dCi 120, i		88/99/107-110				
	2.5 dCi 140, dCi 150						
	1.9 dCi 80, dCi 100	07.02→	59-60/66/74/84-85/		1987 476 914 ¹	222	
	2.0 dCi 90, dCi 120, i		88/99/107-110		1987 481 090 ²	220	
	2.5 dCi 140, dCi 150						
	1.9 dCi 80	ABO 07.02-10.03	59-60/74		0986 480 887	20,6	
	1.9 dCi 100	ABS 07.02-10.03	59-60/74		0986 480 831	25,4	
		ESP 07.02-10.06	59-60/74		TW 0986 480 827	25,4	
		ESP 09.06-10.06	66/84-85		TW 0986 480 827	25,4	
	2.0 dCi 90, dCi 120	ABO 02.03-10.03	88/99		0986 480 887	20,6	
		ABS 02.03-10.03	88/99		0986 480 831	25,4	
		ESP 02.03-10.06	88/99		TW 0986 480 827	25,4	
	2.0 i		11.03-10.06	88/99		TW 0986 480 828	25,4
		2.5 dCi 140	ABO 09.03-10.03	88/99		0986 480 887	20,6
			ABS 09.03-10.03	88/99		0986 480 831	25,4
	ESP 09.03-10.06		88/99		TW 0986 480 827	25,4	
	2.5 dCi 150		11.03-10.06	88/99		TW 0986 480 828	25,4
		ESP 09.06-10.06	107-110		TW 0986 480 827	25,4	
						0986 480 828	25,4



	1.9 dCi 80, dCi 100	07.02→	59-60/66/		1 987 477 116	← 1603	
	2.0 dCi 90, dCi 120, i		74/84-85/		1 987 477 137	→ 1503	
	2.5 dCi 140, dCi 150		88/99/		1 987 482 042	508	
			107-110		FKR,MI	1 987 482 043	1190
					FLR,MI	1 987 482 145	1923

Trade

	2.0D	04.92-12.98	41/46/		0 204 102 295	← 52
	2.8D		57-60/63/		0 204 103 295	↻
	3.0D, D Turbo		78		0 204 102 296	→ 52
					0 204 103 296	↻

	2.8D	03.87-01.91	57-60		0 204 116 324	↔ 25,4

	2.8D	03.87-12.98	57-60		0 204 162 048	

	2.8D	03.87-12.98	57-60		0 204 163 055	
--	------	-------------	-------	--	---------------	--

	2.0D	03.87-12.98	41/46/		0 204 131 142 ¹⁰	
	2.8D		57-60/63/			
	3.0D, D Turbo		78			

Vanette Cargo [C23M]

	1.6i	07.92-10.93	49/71-72		1 987 481 108	530
	2.0D	11.93-11.01	49/71-72		1 987 481 025	535
	2.3D	09.94-11.01	55		1 987 481 025	535

	1.6i	07.92-11.01	49/55/	EIZ	0 986 473 290	↻ ← 60	0 204 104 141 ⁷
	2.0D		71-72		0 986 474 290	↻ → 60	0 204 104 141 ⁷
	2.3D	11.93-11.01	49/55/	ZWZ	0 986 473 132	↻ ← 42,78	
			71-72		0 986 474 132	↻ → 42,78	

	1.6i	07.92-11.01	71-72		1 987 481 146	300
	2.0D	07.92-09.94	49	TW	1 987 481 146	300
	2.3D	09.94-11.01	55		1 987 481 146	300

	1.6i	07.92-11.01	71-72		0 986 475 759	↔ 23,8
		12.97-11.01	71-72	TW	0 986 475 915	↔ 25,4
	2.0D	07.92-11.01	49/55		0 986 475 759	↔ 23,8
	2.3D					





◀ NISSAN Vanette Cargo [C23M]



	1.6 i	07.92-01.94	71-72		1987 477 816	← 1234
	2.0D	07.92-01.94	49	LAU,LXA, SLX	1987 477 816	← 1234

Vanette [C220]



	2.0D	04.87-11.94	44/47-49		1987 476 958	459
--	------	-------------	----------	--	--------------	-----



	2.0D	04.87-04.88	44/47-49		0986 475 761	↔ 22,19
		05.88-11.94	44/47-49		0986 475 558	↔ 20,62



	2.0D	04.87-09.90	44/47-49		0986 480 685	23,8
		10.90-11.94	44/47-49		0986 480 686	23,8

Vanette [GC22]



	1.5	06.86-03.93	47-49/51/		0986 475 558	↔ 20,62
	2.0, D		64/74-77			
	2.4, i					

OPEL

Arena



	1.9D	03.98-08.01	44/55	OE	1987 476 432	315
	2.5D			UE	1987 476 032	315

	1.9D	03.98-08.01	44/55		0204 102 054	→ 45
	2.5D				0204 103 054	



	1.9D	03.98-08.01	44/55		1987 477 662	↔ 747	
		ABO	03.98-08.01	44/55		1987 477 663	← 1330
						1987 477 665	→ 1424
		ABS	03.98-08.01	44/55		1987 477 664	← 1295
						1987 477 666	→ 1390



Campo Pick-Up [TF0]

	2.2D	08.87-08.97	39-45/56/	AA	1 987 476 911	435
	2.3,i		65-72/80	AA	1 987 476 147	515
	2.5 D, TD					
	3.1 TD					
	2.2D	08.87-08.97	39-45/56/	AA	0 986 473 306	← 60
	2.3,i		65-72/80		0 986 474 306	→ 60
	2.5 D, TD					
	3.1 TD					
	2.2D	08.87-08.97	39-45/56/		1 987 476 549	466
	2.3,i		65-72/80			
	2.5 D, TD					
	3.1 TD					
	2.2D	08.87-09.95	39-45/56/		0 986 475 807	↔ 25,4
	2.3,i		65-72/80			
	2.5 D, TD					
	3.1 TD					
	3.1 TD	10.95-08.97	80		0 204 123 508	
	2.3	10.89-08.97	56/65-72		0 986 486 036	
	2.3i					
	2.5 TD					

Campo Pick-Up [TF1]

	2.5 DI	03.97-08.03	56/74/80	AA	1 987 476 911	435
	2.5 DTI			AA	1 987 476 147	515
	3.1 TDS					
	2.5 DI	03.97-08.03	56/74/80	AA	0 986 473 306	← 60
	2.5 DTI				0 986 474 306	→ 60
	3.1 TDS					
	2.5 DI	03.97-08.03	56/74/80		1 987 476 549	466
	2.5 DTI					
	3.1 TDS					
	2.5 DI	03.97-08.03	56/74/80		0 986 475 807	↔ 25,4
	2.5 DTI					
	3.1 TDS					



Combo									
	1.2 i 1.4 i 1.7 D	09.94-10.01	33/44/60/ 66				1987	476 691	340
	1.2 i 1.4 i 1.7 D	09.94-10.01	33/44/60/ 66				0986	471 900	→ 48
							0986	473 900	
					CSA		0986	471 899	← 48
							0986	473 899	
	1.2 i 1.4 i 1.7 D	09.94-10.01	33/44/60/ 66				1987	476 144	412
	1.2 i 1.4 i 1.7 D	09.94-10.01	33/44/60/ 66				0986	475 029	↔ 19,05
	1.2 i	ABO 09.94-10.01	33		LLE		0986	480 130	20,6
		ABS 09.94-10.01	33		LLE		0986	480 818	22
	1.4 i	ABO 09.94-10.01	44/60/66		LLE		0986	480 130	20,6
		ABS 09.94-10.01	44/60/66		LLE		0986	480 818	22
	1.7 D	ABO 09.94-10.01	44		LLE		0986	480 130	20,6
		ABS 09.94-10.01	44		LLE		0986	480 818	22
	1.2 i 1.4 i 1.7 D	09.94-10.01	33/44/60/ 66				1987	477 769	↔ 1659
	1.2 i 1.4 i 1.7 D	09.94-10.01	33/44/60	Fg.Nr. T3000001→		BO	0265	216 410¹¹	
	1.2 i 1.4 i 1.7 D	09.94-10.01	33/44/60/ 66				0986	594 025⁴	
							0986	594 028³	
Combo [Tour]									
	1.3 CDTI 1.4 i Twinport 1.6 CNG, i 1.7 CDTI, DI, DTI	10.01→	48/51/55/ 64/66/ 69-71/74				1987	476 202	
	1.6 CNG 1.7 CDTI	09.04→	69-71/74				0986	473 062	← 57
							0986	474 062	→ 57

		S							
	1.3 CDTI 1.4 i Twinport 1.6 CNG, i 1.7 CDTI, DI, DTI	10.01→	48/51/55/ 64/66/ 69-71/74				1 987 476 200	230	
	1.3 CDTI 1.4 i Twinport 1.6 i 1.7 CDTI, DI, DTI	10.01→	48/51/55/ 64/66/74				0 986 475 143	↔ 19,05	
	1.3 CDTI 1.4 i Twinport 1.6 CNG, i 1.7 CDTI, DI, DTI	10.01→	48/51/55/ 64/66/ 69-71/74				0 986 473 258 0 986 474 258	← 38 → 38	
	1.3 CDTI	ABO 09.04→ ESP 09.04→ OFD 09.04→	51/55 51/55 51/55				0 204 123 662 0 204 123 639 0 204 123 637 0 204 123 640 0 204 123 638	22,19 22,19 23,8 22,19 23,8	
	1.4 i Twinport	ABO 09.04→ ESP 09.04→ OFD 09.04→	66 66 66				0 204 123 662 0 204 123 639 0 204 123 637 0 204 123 640 0 204 123 638	22,19 22,19 23,8 22,19 23,8	
	1.6 CNG	ABO 04.05→ ESP 04.05→ OFD 04.05→	69-71 69-71 69-71	Fg.Nr. 43000001→ Fg.Nr. 43000001→, 44000001→, 46000001→ Fg.Nr. 44000001→, 46000001→		STB STB STB	0 204 123 662 0 204 123 659 0 204 123 659 0 204 123 637 0 204 123 639 0 204 123 638 0 204 123 640	22,19 22,19 22,19 23,8 22,19 23,8 22,19	
	1.6 i	10.01-08.04	64				DMO 0 986 480 859	22	
	1.7 CDTI	ABO 09.04→ ESP 09.04→ OFD 09.04→	74 74 74				0 204 123 662 0 204 123 639 0 204 123 637 0 204 123 640 0 204 123 638	22,19 22,19 23,8 22,19 23,8	
	1.7 DI, DTI	10.01-08.04	48/55				DMO 0 986 480 859	22	
	1.3 CDTI 1.4 i Twinport 1.6 CNG 1.6 i 1.7 CDTI	ABO 09.04→ ABS 09.04→ ABO 09.04→ ABS 09.04→ ABO 10.01-08.04 ABS 10.01-08.04 ABO 09.04→ ABS 09.04→	51/55 51/55 66 66 64 64 74 74	Fg.Nr. 43000001→, 44000001→, 46000001→ Fg.Nr. 43000001→, 44000001→, 46000001→ Fg.Nr. 43000001→, 44000001→, 46000001→			0 204 125 812 0 204 125 813 0 204 125 812 0 204 125 813 0 204 125 812 0 204 125 813 0 204 125 812 0 204 125 813		





◀ OPEL Combo [Tour]

1.7 DI	ABO	10.01-08.04	48/55	Fg.Nr. 43000001→, 44000001→, 46000001→	0 204 125 812	
1.7 DTI	ABS	10.01-08.04	48/55	Fg.Nr. 43000001→, 44000001→, 46000001→	0 204 125 813	

	1.3 CDTI		09.04→	51/55	STB	1987 477 869	1238
		ABO	09.04→	51/55	4SB	1987 477 869	1238
		ABS	09.04→	51/55	4SB	1987 482 138	2067
1.4 i Twinport			09.04→	66	STB	1987 477 869	1238
		ABO	09.04→	66	4SB	1987 477 869	1238
		ABS	09.04→	66	4SB	1987 482 138	2067
1.6 CNG			04.05→	69-71	STB	1987 477 869	1238
		ABO	04.05→	69-71	4SB	1987 477 869	1238
		ABS	04.05→	69-71	4SB	1987 482 138	2067
1.6 i			10.01-08.04	48/55/64/74	STB	1987 477 869	1238
		ABO	10.01-08.04	48/55/64/74	4SB	1987 477 869	1238
		ABS	10.01-08.04	48/55/64/74	4SB	1987 482 138	2067
1.7 CDTI			10.01→	48/55/64/74	STB	1987 477 869	1238
1.7 DI	ABO		10.01→	48/55/64/74	4SB	1987 477 869	1238
1.7 DTI	ABS		10.01→	48/55/64/74	4SB	1987 482 138	2067

	1.3 CDTI		09.04→	51/55/66	EAY	0 265 231 444 ¹¹	
	1.4 i Twinport				Fg.Nr. →43999999, →44999999, →46999999 GS	0 265 231 307 ¹¹	
					Fg.Nr. 53000001→, 54000001→, 56000001→ GS	0 265 231 584 ¹¹	
1.6 CNG			04.05→	69-71	Fg.Nr. 53000001→, 54000001→, 56000001→ GS	0 265 231 584 ¹¹	
1.6 i			10.01-08.04	64	Fg.Nr. →43999999, →44999999, →46999999 GS	0 265 231 307 ¹¹	
1.7 CDTI			09.04→	74	EAY	0 265 231 444 ¹¹	
					Fg.Nr. →43999999, →44999999, →46999999 GS	0 265 231 307 ¹¹	
					Fg.Nr. 53000001→, 54000001→, 56000001→ GS	0 265 231 584 ¹¹	
1.7 DI		10.01-08.04	48/55	Fg.Nr. →43999999, →44999999, →46999999 GS	0 265 231 307 ¹¹		
1.7 DTI							

	1.3 CDTI		10.01→	48/51/55/		0 986 594 027 ³	
	1.4 i Twinport			64/66/			
	1.6 CNG, i			69-71/74			
	1.7 CDTI, DI, DTI						

	1.6 CNG		04.05→	69-71		0 265 005 303	
--	---------	--	--------	-------	--	---------------	--

Corsa [C]



	1.8 i		10.02→	79	DMO	0 986 480 859	22
--	-------	--	--------	----	-----	---------------	----

	1.8 i		01.02→	79		0 204 125 812	
--	-------	--	--------	----	--	---------------	--

	1.8 i		01.02→	79		0 265 216 479 ¹¹	
--	-------	--	--------	----	--	-----------------------------	--



Movano



1.9D	01.99-10.01	59	Fg.Nr. →3V999999, →3Y999999	OE,STB	1 987 476 906	565
				STB,UE	1 987 476 907	610
1.9DTI	09.00-08.03	60/66	Fg.Nr. →3V999999, →3Y999999	4SB,UE	1 987 481 151	538
				4SB,OE	1 987 481 150	507
2.2DTI	09.03-10.05	60/66	Fg.Nr. →3V999999, →3Y999999	OE,STB	1 987 476 906	565
				STB,UE	1 987 476 907	610
2.5D	10.98-09.01	59	Fg.Nr. →3V999999, →3Y999999	4SB,UE	1 987 481 151	538
				4SB,OE	1 987 481 150	507
2.5DTI	10.01-08.03	73-74/84	Fg.Nr. →3V999999, →3Y999999	OE,STB	1 987 476 906	565
				STB,UE	1 987 476 907	610
2.8DTI	09.03→	73-74/84	Fg.Nr. →3V999999, →3Y999999	4SB,UE	1 987 481 151	538
				4SB,OE	1 987 481 150	507
3.0CDTI	08.06→	88/107	Fg.Nr. 4V000001→, 4Y000001→		1 987 481 186	545
					1 987 481 186	545
1.9D, DTI	06.98→	59/60/66/ 73-74/84/ 88/100/ 107	Fg.Nr. →3V999999, →3Y999999	OE,STB	1 987 476 906	565
				STB,UE	1 987 476 907	610
2.2DTI	06.98-09.02	84	Fg.Nr. →3V999999, →3Y999999	4SB,UE	1 987 481 151	538
				4SB,OE	1 987 481 150	507
2.5D, DTI	09.03-10.05	100	Fg.Nr. 4V000001→, 4Y000001→		1 987 481 186	545
					1 987 481 186	545
2.8DTI	06.98-09.02	84	Fg.Nr. →3V999999, →3Y999999	OE,STB	1 987 476 906	565
				STB,UE	1 987 476 907	610
3.0CDTI	09.03-10.05	100	Fg.Nr. 4V000001→, 4Y000001→	4SB,UE	1 987 481 151	538
				4SB,OE	1 987 481 150	507



1.9D, DTI	06.98→	59/60/66/ 73-74/84/ 88/100/ 107	Fg.Nr. →3V999999, →3Y999999	15Z	0 204 102 730	← 45
					0 204 103 730	↻
2.2DTI	06.98-09.02	84	Fg.Nr. →3V999999, →3Y999999		0 204 102 731	→ 45
					0 204 103 731	↻
2.5D, DTI	09.03-10.05	100	Fg.Nr. 4V000001→, 4Y000001→	16Z	0 986 473 328	↻ ← 45
					0 986 474 328	↻ → 45



1.9D	01.99-10.01	59	Fg.Nr. →3V999999, →3Y999999	LF	1 987 476 905 ¹	435
					1 987 481 152	358
1.9DTI	09.00-08.03	60/66	Fg.Nr. →3V999999, →3Y999999		1 987 481 152	358
					1 987 481 152	358
2.2DTI	09.00-10.05	60/66	Fg.Nr. →3V999999, →3Y999999	LF	1 987 476 905 ¹	435
					1 987 481 057	492
2.5D	10.98-09.01	59	Fg.Nr. 4V000001→, 4Y000001→		1 987 481 074	← 480
					1 987 481 074	← 480
2.5DTI	09.03-10.05	60/66	Fg.Nr. 4V000001→, 4Y000001→	LF	1 987 476 905 ¹	435
					1 987 481 152	358



◀ OPEL Movano										
2.5 DTI	10.01-08.03	73-74/84	Fg.Nr. →3V999999, →3Y999999				1987	481 152	358	
	10.01→	73-74/84		LF			1987	476 905¹	435	
	09.03→	73-74/84	Fg.Nr. 4V000001→, 4Y000001→				1987	481 057	492	
									→ 492	
									← 480	
									← 480	
2.8 DTI	06.98-09.02	84		LF			1987	476 905¹	435	
			Fg.Nr. →3V999999, →3Y999999				1987	481 152	358	
	08.06→	88/107					1987	481 057	492	
3.0 CDTI	03.03-10.05	100		LF			1987	476 905¹	435	
	09.03-10.05	100	Fg.Nr. 4V000001→, 4Y000001→				1987	481 057	492	
									→ 492	
									← 480	
	1.9 D, DTI	06.98→	59/60/66/				F 026	002 532	← 23,8	
	2.2 DTI		73-74/84/				F 026	002 533	→ 23,8	
	2.5 D, DTI		100							
	2.8 DTI									
	3.0 CDTI									
	1.9 D	01.99-10.01	59				0 204	004 320	← 42	
							0 986	473 260		
	1.9 DTI	10.01-08.03	60				0 204	004 320	← 42	
							0 986	473 260		
							0 204	004 321	→ 42	
							0 986	474 260		
	09.03-10.05	60					0 204	004 320	← 42	
							0 986	473 260		
							0 204	004 321	→ 42	
							0 986	474 260		
	2.2 DTI	09.00-08.03	66				0 204	004 320	← 42	
							0 986	473 260		
						0 204	004 321	→ 42		
						0 986	474 260			
03.01-08.03	66					0 204	004 320	← 42		
						0 986	473 260			
09.03-10.05	66					0 204	004 320	← 42		
						0 986	473 260			
						0 204	004 321	→ 42		
						0 986	474 260			
2.5 D	10.98-09.01	59				0 204	004 320	← 42		
						0 986	473 260			
						0 204	004 321	→ 42		
						0 986	474 260			
2.5 DTI	10.01-08.03	73-74				0 204	004 320	← 42		
						0 986	473 260			
						0 204	004 321	→ 42		
						0 986	474 260			
	84						0 204	004 320	← 42	
							0 986	473 260		
							0 204	004 321	→ 42	
							0 986	474 260		
	09.03-10.07	84					0 204	004 320	← 42	
							0 986	473 260		
						0 204	004 321	→ 42		
						0 986	474 260			



2.5 DTI	09.03→	73-74		0 204 004 320	← 42
				0 986 473 260	↻
	08.06→	88/107		0 204 004 321	→ 42
				0 986 474 260	↻
2.8 DTI	06.98-09.02	84		0 204 004 320	← 42
				0 986 473 260	↻
3.0 CDTI	09.03-10.05	100		0 204 004 321	→ 42
				0 986 474 260	↻



	1.9 D, DTI	06.98→	59/60/66/		1 987 482 012	1175
	2.2 DTI		73-74/84/	ABM	1 987 477 261	1737
	2.5 D, DTI		88/100/		1 987 482 013	↔ 1420
	2.8 DTI		107			
	3.0 CDTI					

Vivaro



	1.9 CDTI, DTI	03.01→	60/66/74/		1 987 476 700	380
	2.0 CDTI, 16V		84/86-88/			
	2.5 CDTI		99/107			

	1.9 CDTI, DTI	03.01→	60/66/74/	Fg.Nr. →6V699999,	0 986 473 424	↻ ← 45
	2.0 CDTI, 16V		84/86-88/	→6Y999999	0 986 474 424	↻ → 45
	2.5 CDTI		99/107			



	1.9 CDTI, DTI	03.01→	60/66/74/		1 987 476 914	222
	2.0 CDTI, 16V		84/86-88/			
	2.5 CDTI		99/107			



	1.9 CDTI	ESP	03.01-08.06	60/74		0 986 480 827	25,4	
	1.9 DTI	OFD	03.01-08.06	60/74	Fg.Nr. →4V602167	LLE	0 986 480 887	20,6
						RLE	0 986 480 831	25,4
					Fg.Nr. 4V602168→	RLE	0 986 480 828	25,4
	2.0 16V	ESP	03.01→	86-88/99		0 986 480 827	25,4	
	2.5 CDTI	OFD	03.01→	86-88/99	Fg.Nr. →4V602167		0 986 480 831	25,4
					Fg.Nr. 4V602168→		0 986 480 828	25,4

	1.9 CDTI	03.01→	60/66/74/		1 987 477 116	→ 1603
	1.9 DTI		84/86-88/		1 987 477 137	← 1503
	2.0 CDTI		99/107	FKR,MI	1 987 482 043	1190
	2.0 16V			FLR,MI	1 987 482 145	1923
	2.5 CDTI			LLE	1 987 482 042	508
				RLE	1 987 482 146	2198





◀ OPEL Vivaro

	1.9 CDTI, DTI	03.01→	60/66/74/	Fg.Nr. 7V600001→,	0 265 008 077 ³	
	2.0 CDTI, 16V		84/86-88/	7Y000001→	0 265 008 078 ⁴	
	2.5 CDTI		99/107			

PEUGEOT

Bipper [A9]



	1.4 HDi	02.08→	50		1 987 482 207	→ 1650
					1 987 482 208	← 1584
	1.4 i	02.08→	54		1 987 482 205	→ 1604
					1 987 482 206	← 1555

Boxer



	2.8 D	ABO 01.02→	66/77/90/	INB	0 986 473 161	↔ 40,39
	2.8 D Interc.		93		0 986 474 161	↔ 40,39
	2.8 D Turbo			L02	0 986 473 163	↔ 44,95
	2.8 HDI				0 986 474 163	↔ 44,95
					L03	0 986 473 162
					0 986 474 162	↔ 40,39



	2.8 D, D Interc.	01.02→	66/77/90/	APD	0 986 475 906	↔ 26,99
	2.8 D Turbo, HDI		93	L06	0 986 475 801	↔ 25,4
				L07	0 986 475 802	↔ 27



	2.8 D, D Interc.	ABO 01.02→	66/77/90/93		0 204 123 616	25,4
	2.8 D Turbo, HDI	ABS 01.02→	66/77/90/		0 204 123 615	25,4
			93	L02,LLE	F 026 003 313	25,4

	2.8 D, D Interc.	01.02→	66/77/90/		0 204 125 801	
	2.8 D Turbo, HDI		93	Fg.Nr. →15064995	L03	0 204 125 445
				Fg.Nr. →15984271	L02	0 204 125 746
				Fg.Nr. 15984272→		0 204 125 772

	2.8 D, D Interc.	01.02→	66/77/90/	Fg.Nr. 15445358→	L02	0 265 216 530 ¹¹
	2.8 D Turbo, HDI		93		L03	0 265 216 436 ¹¹

	2.8 D, D Interc.	01.02→	66/77/90/	Fg.Nr. 15445358→	LAB	0 265 006 405 ⁴
	2.8 D Turbo, HDI		93		RAB	0 265 006 406 ⁴

Boxer [U3]



	1.9 D	ABO 02.94-02.02	50/51	OE	1 987 476 329	485
				UE	1 987 481 063	490
		ABS 02.94-02.02	50/51		1 987 476 329	485
				Fg.Nr. →15445357	1 987 476 329	485

		S											
1.9 D Turbo	ABO	02.94-02.02	66/68				OE	1 987 476 329	485				
							UE	1 987 481 063	490				
2.0 2.0 HDi 2.0 i	ABO	02.94-02.02	62/79/80				OE	1 987 476 329	485				
							UE	1 987 481 063	490				
							ABS	02.94-02.02	62/79/80				1 987 476 329
										Fg.Nr. →15445357	1 987 476 329	485	
2.5 D	ABO	02.94-02.02	62/63				OE	1 987 476 329	485				
							UE	1 987 481 063	490				
							ABS	02.94-02.02	62/63				1 987 476 329
										Fg.Nr. →15445357	1 987 476 329	485	
2.5 D Turbo	ABO	02.94-02.02	64/76/79/				OE	1 987 476 329	485				
2.5 TDi			90/94				UE	1 987 481 063	490				
	ABS	02.94-02.02	64/76/79/					1 987 476 329	485				
			90/94					1 987 476 329	485				
										Fg.Nr. →15445357	1 987 476 329	485	
2.8 D	ABO	01.99-02.02	64/76/79/				OE	1 987 476 329	485				
2.8 D Turbo			90/94				UE	1 987 481 063	490				
2.8 HDi	ABS	01.99-02.02	64/76/79/					1 987 476 329	485				
			90/94					1 987 476 329	485				
										Fg.Nr. →15445357	1 987 476 329	485	
	1.9 D, D Turbo	ABO	02.94-02.02	50/51/62/			INB	0 986 473 161		← 40,39			
	2.0, HDi, i			63/64/66/				0 986 474 161		→ 40,39			
	2.5 D, D Turbo, TDi			68/76/79/			L02	0 986 473 163		← 44,95			
	2.8 D, D Turbo, HDi			80/90/94				0 986 474 163		→ 44,95			
							L03	0 986 473 162		← 40,39			
								0 986 474 162		→ 40,39			
	1.9 D	ABO	02.94-02.02	50/51			FCC,FEN	1 987 481 017	360				
							VFC	1 987 481 002	360				
		ABS	02.94-02.02	50/51				FCC,FEN	1 987 476 689	← 335			
	1.9 D Turbo	ABO	02.94-02.02	66/68			FCC,FEN	1 987 481 017	360				
								VFC	1 987 481 002	360			
		ABS	02.94-02.02	66/68				FCC,FEN	1 987 476 689	← 335			
	2.0	ABO	02.94-02.02	62/79/80			FCC,FEN	1 987 481 017	360				
	2.0 HDi							VFC	1 987 481 002	360			
	2.0 i	ABS	02.94-02.02	62/79/80				FCC,FEN	1 987 476 689	← 335			
	2.5 D	ABO	02.94-02.02	62/63				FCC,FEN	1 987 481 017	360			
								VFC	1 987 481 002	360			
		ABS	02.94-02.02	62/63				FCC,FEN	1 987 476 689	← 335			
	2.5 D Turbo	ABO	02.94-02.02	64/76/79/				FCC,FEN	1 987 481 017	360			
	2.5 TDi			90/94				VFC	1 987 481 002	360			
		ABS	02.94-02.02	64/76/79/90/94				FCC,FEN	1 987 476 689	← 335			
	2.8 D	ABO	01.99-02.02	64/76/79/				FCC,FEN	1 987 481 017	360			
	2.8 D Turbo			90/94				VFC	1 987 481 002	360			
2.8 HDi	ABS	01.99-02.02	64/76/79/90/94				FCC,FEN	1 987 476 689	← 335				
	1.9 D, D Turbo		02.94-02.02	50/51/62/			L02	0 986 475 803	↔	28,6			
	2.0, HDi, i			63/64/66/			L06	0 986 475 801	↔	25,4			
	2.5 D, D Turbo, TDi			68/76/79/			L07	0 986 475 802	↔	27			
	2.8 D, D Turbo, HDi			80/90/94									





◀ PEUGEOT Boxer [U3]



	1.9D	ABO	02.94-12.94	51	L03,RLE	0 204 123 319	22,19		
			02.94-02.02	51	L02,RLE	0 204 123 314	25,4		
			01.95-02.02	51	L03,RLE	0 204 123 325	23,8		
			07.98-02.02	50	L02,RLE	0 204 123 314	25,4		
					L03,RLE	0 204 123 325	23,8		
ABS	02.94-12.94	51	L03	0 204 123 320	22,19				
			L03,LLE	F 026 003 318	22,19				
				F 026 003 315	25,4				
				F 026 003 313	25,4				
				F 026 003 315	25,4				
1.9D Turbo	ABO	02.94-12.94	66/68	L03,RLE	0 204 123 319	22,19			
				L02,RLE	0 204 123 314	25,4			
				L03,RLE	0 204 123 325	23,8			
				ABS	02.94-12.94	66/68	L03	0 204 123 320	22,19
							L03,LLE	F 026 003 318	22,19
2.0	ABO	02.94-12.94	79	L02,LLE	F 026 003 313	25,4			
				L03,RLE	0 204 123 319	22,19			
				L02,RLE	0 204 123 314	25,4			
				L03,RLE	0 204 123 325	23,8			
				ABS	02.94-12.94	79	L03	0 204 123 320	22,19
L03,LLE	F 026 003 318	22,19							
	F 026 003 315	25,4							
	F 026 003 313	25,4							
	F 026 003 313	25,4							
2.0 HDi	ABO	09.01-02.02	62	L02,RLE	0 204 123 314	25,4			
				L03,RLE	0 204 123 325	23,8			
				ABS	09.01-02.02	62	L02,LLE	F 026 003 313	25,4
							L03,RLE	0 204 123 325	23,8
				2.0 i	ABO	02.94-12.94	80	L03,RLE	0 204 123 319
L02,RLE	0 204 123 314	25,4							
L03,RLE	0 204 123 325	23,8							
ABS	02.94-12.94	80	L03					0 204 123 320	22,19
			L03,LLE					F 026 003 318	22,19
2.5 D	ABO	02.94-12.94	63	L02,LLE	F 026 003 313	25,4			
				L03,RLE	0 204 123 319	22,19			
				L02,RLE	0 204 123 314	25,4			
				L03,RLE	0 204 123 325	23,8			
				ABS	02.94-12.94	63	L02,RLE	0 204 123 314	25,4
L03,RLE	0 204 123 325	23,8							
L03	0 204 123 320	22,19							
L03,LLE	F 026 003 318	22,19							
	F 026 003 315	25,4							
2.5 D Turbo	ABO	02.94-12.94	76	L02,LLE	F 026 003 313	25,4			
				L03,RLE	0 204 123 319	22,19			
				L02,RLE	0 204 123 314	25,4			
				L03,RLE	0 204 123 325	23,8			
				ABS	02.94-12.94	76	L02,RLE	0 204 123 314	25,4
L03,RLE	0 204 123 325	23,8							
L03	0 204 123 320	22,19							
L03,LLE	F 026 003 318	22,19							
	F 026 003 315	25,4							
2.5 TDi	ABO	10.96-02.02	64/79/90/ 94	L02,LLE	F 026 003 313	25,4			
				L03,RLE	0 204 123 319	22,19			
				L02,RLE	0 204 123 314	25,4			
				L03,RLE	0 204 123 325	23,8			
				ABS	10.96-02.02	64/79/90/ 94	L03	0 204 123 320	22,19
L03,LLE	F 026 003 318	22,19							
	F 026 003 315	25,4							
	F 026 003 313	25,4							
	F 026 003 313	25,4							

		S							
2.8 D	ABO	01.99-02.02	64/79/90/			L02,RLE	0 204 123 314	25,4	
2.8 D Turbo			94			L03,RLE	0 204 123 325	23,8	
2.8 HDi	ABS	01.99-02.02	64/79/90/				F 026 003 315	25,4	
			94			L02,LLE	F 026 003 313	25,4	
1.9 D		02.94-02.02	50/51/66/	Fg.Nr. →15064995		L03	0 204 125 445		
1.9 D Turbo			68	Fg.Nr. 15064996→15984271		L03,LLE	0 204 125 746		
				Fg.Nr. 15687087→15984271		RLE	0 204 125 746		
				Fg.Nr. →15984271		L02,LLE	0 204 125 746		
				Fg.Nr. 15984272→		LLE	0 204 125 772		
						L02,RLE	0 204 125 772		
						L03,RLE	0 204 125 773		
2.0		02.94-02.02	79	Fg.Nr. →15064995		L03	0 204 125 445		
				Fg.Nr. 15064996→15984271		L03	0 204 125 746		
				Fg.Nr. →15984271		L02	0 204 125 746		
				Fg.Nr. 15984272→			0 204 125 772		
2.0 HDi		09.01-02.02	62	Fg.Nr. →15984271			0 204 125 746		
				Fg.Nr. 15984272→			0 204 125 772		
2.0 i		02.94-02.02	80	Fg.Nr. →15064995		L03	0 204 125 445		
				Fg.Nr. 15064996→15984271		L03	0 204 125 746		
				Fg.Nr. →15984271		L02	0 204 125 746		
				Fg.Nr. 15984272→			0 204 125 772		
2.5 D		01.99-02.02	62	Fg.Nr. →15984271			0 204 125 746		
				Fg.Nr. 15984272→			0 204 125 772		
2.5 D		02.94-02.02	63/76	Fg.Nr. →15064995		L03	0 204 125 445		
2.5 D Turbo				Fg.Nr. 15064996→15984271		L03	0 204 125 746		
				Fg.Nr. →15984271		L02	0 204 125 746		
				Fg.Nr. 15984272→			0 204 125 772		
2.5 TDi		10.96-02.02	64/79/90/	Fg.Nr. →15984271			0 204 125 746		
2.8 D, D Turbo, HDi			94	Fg.Nr. 15984272→			0 204 125 772		
1.9 D	ABO	02.94-02.02	51				0 204 131 232 ¹⁰		
		07.98-02.02	50				0 204 131 232 ¹⁰		
	ABS	02.94-06.97	51	Fg.Nr. →15445357			0 204 131 217 ¹⁰		
1.9 D Turbo	ABO	02.94-02.02	66/68				0 204 131 232 ¹⁰		
	ABS	02.94-06.97	66/68	Fg.Nr. →15445357			0 204 131 217 ¹⁰		
2.0	ABO	02.94-02.02	79/80				0 204 131 232 ¹⁰		
2.0 i	ABS	02.94-06.97	79/80	Fg.Nr. →15445357			0 204 131 217 ¹⁰		
2.5 D	ABO	01.99-02.02	62				0 204 131 232 ¹⁰		
2.5 D, D Turbo, TDi	ABO	02.94-02.02	63/76/79				0 204 131 232 ¹⁰		
	ABS	02.94-06.97	63/76/79	Fg.Nr. →15445357			0 204 131 217 ¹⁰		
2.8 D, D Turbo	ABO	01.99-02.02	64/90				0 204 131 232 ¹⁰		
1.9 D		02.94-02.02	50/51/66/			AA,FEV	1 987 482 005	4100	
1.9 D Turbo			68			LLE	1 987 477 114	1059	
						RLE	1 987 482 046	1137	
				Fg.Nr. →16158427		AA,FCC,FEN	1 987 477 113	3025	
						AA,VFC	1 987 477 115	3040	
				Fg.Nr. 16158428→		AA,FCC,FEN	1 987 477 262	2806	
						AA,VFC	1 987 482 006	2827	
2.0		02.94-02.02	79			LLE	1 987 477 114	1059	
						RLE	1 987 482 046	1137	
				Fg.Nr. →16158427		FCC,FEN	1 987 477 113	3025	
						VFC	1 987 477 115	3040	
				Fg.Nr. 16158428→		FCC,FEN	1 987 477 262	2806	
						VFC	1 987 482 006	2827	
2.0 HDi		09.01-02.02	62			AA,FEV	1 987 482 005	4100	
						LLE	1 987 477 114	1059	
						RLE	1 987 482 046	1137	
				Fg.Nr. →16158427		AA,FCC,FEN	1 987 477 113	3025	
						AA,VFC	1 987 477 115	3040	
				Fg.Nr. 16158428→		AA,FCC,FEN	1 987 477 262	2806	
						AA,VFC	1 987 482 006	2827	



PEUGEOT Boxer [U3]

2.0 i	02.94-02.02	80	LLE	1987	477 114	1059	
			RLE	1987	482 046	1137	
			Fg.Nr. →16158427	FCC,FEN	1987	477 113	3025
				VFC	1987	477 115	3040
			Fg.Nr. 16158428→	FCC,FEN	1987	477 262	2806
				VFC	1987	482 006	2827
2.5 D, D Turbo, TDi	02.94-02.02	62/63/64/	AA,FEV	1987	482 005	4100	
2.8 D, D Turbo, HDi		76/79/90/ 94	LLE	1987	477 114	1059	
			RLE	1987	482 046	1137	
			Fg.Nr. →16158427	AA,FCC,FEN	1987	477 113	3025
				AA,VFC	1987	477 115	3040
			Fg.Nr. 16158428→	AA,FCC,FEN	1987	477 262	2806
				AA,VFC	1987	482 006	2827

	1.9 D, D Turbo	02.94-02.02	50/51/62/	Fg.Nr. 15445358→	L02	0 265	216 530 ¹¹
	2.0, HDi, i		63/64/66/		L03	0 265	216 436 ¹¹
	2.5 D, D Turbo, TDi		68/76/79/				
	2.8 D, D Turbo, HDi		80/90/94				

















	1.9 D, D Turbo	02.94-02.02	50/51/62/	Fg.Nr. 15445358→	L03	1 273	004 168 ¹⁶
	2.0, HDi, i		63/64/66/				
	2.5 D, D Turbo, TDi		68/76/79/				
	2.8 D, D Turbo, HDi		80/90/94				

	1.9 D	02.94-04.00	50/51/66/	Fg.Nr. 15445358→		0 265	006 427 ³
	1.9 D Turbo		68/79				
2.0		02.94-02.02	50/51/66/	Fg.Nr. 15445358→	LAB	0 265	006 405 ⁴
					RAB	0 265	006 406 ⁴
2.0 HDi		09.01-02.02	62	Fg.Nr. 15445358→	LAB	0 265	006 405 ⁴
					RAB	0 265	006 406 ⁴
2.0 i		02.94-04.00	62/63/64/	Fg.Nr. 15445358→		0 265	006 427 ³
2.5 D, D Turbo, TDi			76/79/80/90				
2.8 D, D Turbo		02.94-02.02	62/63/64/	Fg.Nr. 15445358→	LAB	0 265	006 405 ⁴
					RAB	0 265	006 406 ⁴
2.8 HDi		09.00-02.02	94	Fg.Nr. 15445358→	LAB	0 265	006 405 ⁴
					RAB	0 265	006 406 ⁴

Boxer [U5]

	2.0 HDi	ABO	02.02-05.06	62/74/80/90	UE	1987	481 004	470
	2.2 HDi	ABO	02.02-05.06	62/74/80/90	UE	1987	481 004	470
	2.8 D Turbo	ABO	02.02-05.06	62/74/80/90	UE	1987	481 004	470
	2.8 HDi	ABO	02.02-05.06	94/107	UE	1987	481 004	470

	2.0 HDi		02.02-05.06	62/74/80/90	SBR	1987	476 629 ²	160
	2.2 HDi	ABO	02.02-05.06	62/74/80/90	LAB	1987	481 018 ¹	385
	2.2 HDi	ABO	02.02-05.06	62/74/80/90	SBR	1987	476 629 ²	160
	2.2 HDi	ABS	02.02-05.06	62/74/80/90	LAB	1987	481 018 ¹	385

		S							
2.8 D Turbo		02.02-05.06	62/74/80/90		SBR	1 987 476 629 ²	160		
	ABO	02.02-05.06	62/74/80/90			1 987 481 002 ¹	360		
	ABS	02.02-05.06	62/74/80/90		LAB	1 987 481 018 ¹	385		
					RAB	1 987 481 019 ¹	385		
2.8 HDi		02.02-05.06	94/107		SBR	1 987 476 629 ²	160		
	ABO	02.02-05.06	94/107			1 987 481 002 ¹	360		
	ABS	02.02-05.06	94/107		LAB	1 987 481 018 ¹	385		
					RAB	1 987 481 019 ¹	385		
	2.0 HDi, i	02.02→	62/74/80/		APD	0 986 475 906	↔ 26,99		
	2.2 HDi		90/94/107						
	2.8 D Turbo, HDi								
									
	2.0 HDi	ABO	02.02-05.06	62/74/80/90		0 204 123 616	25,4		
	2.0 i	ABS	02.02-05.06	62/74/80/90		0 204 123 615	25,4		
	2.2 HDi	ABO	02.02-05.06	62/74/80/90		0 204 123 616	25,4		
		ABS	02.02-05.06	62/74/80/90		0 204 123 615	25,4		
	2.8 D Turbo	ABO	02.02-05.06	62/74/80/90		0 204 123 616	25,4		
		ABS	02.02-05.06	62/74/80/90		0 204 123 615	25,4		
	2.8 HDi	ABO	02.02-05.06	94/107		0 204 123 616	25,4		
		ABS	02.02-05.06	94/107		0 204 123 615	25,4		
	2.0 HDi, i	02.02-05.06	62/74/80/			0 204 125 801			
	2.2 HDi		90/94/107						
	2.8 D Turbo, HDi								
	2.0 HDi	02.02→	62		FGN,L02	0 204 031 185 ¹⁰			
					L02,VFG	0 204 031 202 ¹⁰			
					L06	0 204 031 182 ¹⁰			
					L07,VFG	0 204 031 184 ¹⁰			
	2.0 i	02.02→	74/80/90/		FGN,L02	0 204 031 185 ¹⁰			
		2.2 HDi		94/107		FGN,L07	0 204 031 183 ¹⁰		
		2.8 D Turbo				L02,VFG	0 204 031 202 ¹⁰		
		2.8 HDi				L06	0 204 031 182 ¹⁰		
						L07,VFG	0 204 031 184 ¹⁰		
			2.0 HDi, i	02.02-05.06	62/74/80/		LLE	1 987 482 002	1078
2.2 HDi			90/94/107		RLE	1 987 482 004	1170		
2.8 D Turbo, HDi					SBR	1 987 482 003	2715		
					TBR	1 987 477 263	2827		
Boxer [U9]									
									
	2.2 HDi	06.06→	74/88/115			1 987 482 213	↔ 1593		
	3.0 HDi					1 987 482 214	↔ 335		
	2.2 HDi	06.06-01.07	74/88/115			0 265 008 018 ⁴			
	3.0 HDi								



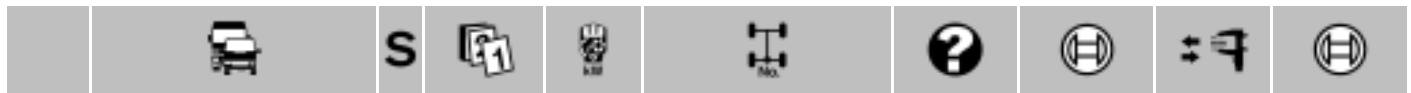

Expert [G9]

	1.6 HDi	02.07→	66			0986 475 950	↔
	1.6 HDi	02.07→	66	FKR,SBR	1987 482 007	↔ 1614	
				FLR,SBR	1987 482 008	↔ 1737	
				TBR	1987 482 118	↔ 1718	
	2.0 HDi	02.07→	88/100/	FKR	1987 482 007	↔ 1614	
	2.0 i 16V		103	FLR	1987 482 008	↔ 1737	
	1.6 HDi	08.07-07.08	66/88/100/	Org.Nr. 11208→11556		0265 234 213 ²⁶	
	2.0 HDi		103				
	2.0 i 16V	08.08→	66/88/100/	Org.Nr. 11557→		0265 230 078 ²⁶	
			103				
	1.6 HDi	02.07→	66/88/100/			0265 007 790 ³	
	2.0 HDi		103			0265 007 791 ⁴	
	2.0 i 16V						
	1.6 HDi	02.07-11.07	66/88/100/	Org.Nr. →11318		0265 005 606	
	2.0 HDi		103				
	2.0 i 16V	12.07-07.08	66/88/100/	Org.Nr. 11319→11556		0265 005 724	
			103				
		12.08→	66/88/100/	Org.Nr. 11683→		0265 005 765	
			103				

Expert [U64]

	1.6 i	09.95-01.07	51/52/58/			1987 476 951	470
	1.8 i		66-68/70/				
	1.9 D, D Turbo		80/81/100				
	2.0 HDi, i 16V						
	1.6 i	09.95→	51/52/58/	BSY	0204 102 521	← 57	0204 100 316 ⁸
	1.8 i		66-68/70/		0204 103 521	↻	0204 104 177 ⁷
	1.9 D		80/81/100		0204 102 523	→ 57	0204 100 316 ⁸
	1.9 D Turbo				0204 103 523	↻	
	2.0 HDi			LUC	0986 473 115	↻ ← 57,1	
	2.0 i 16V				0986 474 115	↻ → 57,1	
	1.6 i	09.95-01.07	51/52/58/			1987 476 947 ¹	250
	1.8 i		66-68/70/				
	1.9 D, D Turbo		80/81/100				
	2.0 HDi, i 16V						
	1.6 i	09.95→	51/52/58/			F 026 002 181	↔ 19,05
	1.8 i		66-68/70/				
	1.9 D, D Turbo		80/81/100				
	2.0 HDi, i 16V						

		S							
	1.6 i	ABO	09.95-05.99	58/70	Org.Nr. →8206		F 026 003 166	23,8	
	1.8 i		06.99-01.07	58/70	Org.Nr. 8207→		F 026 003 188	22,19	0 204 124 059 ⁶
							F 026 003 517	23,8	
	ABS	09.95-05.99	58/70		Org.Nr. →8206		F 026 003 518	22,19	0 204 124 136 ⁶
			06.99-01.07	58/70	Org.Nr. 8207→		F 026 003 516	23,8	
							F 026 003 518	22,19	
	1.9 D	ABO	09.95-05.99	51	Org.Nr. →8206		F 026 003 166	23,8	
			06.99-08.01	51	Org.Nr. 8207→		F 026 003 188	22,19	0 204 124 059 ⁶
							F 026 003 517	23,8	
			09.01-01.07	52			F 026 003 188	22,19	
							F 026 003 517	23,8	
	ABS	09.95-05.99	51		Org.Nr. →8206		F 026 003 518	22,19	0 204 124 136 ⁶
			06.99-08.01	51	Org.Nr. 8207→		0 204 123 182	23,8	
							F 026 003 516	23,8	
			09.01-01.07	52			F 026 003 518	22,19	
							F 026 003 518	22,19	
	1.9 D Turbo	ABO	09.95-07.98	68			F 026 003 166	23,8	
			09.95-05.99	66-68	Org.Nr. →8206		F 026 003 188	22,19	0 204 124 059 ⁶
							F 026 003 166	23,8	
			06.99-05.00	66-68	Org.Nr. 8207→		F 026 003 188	22,19	0 204 124 059 ⁶
							F 026 003 517	23,8	
	ABS	09.95-07.98	68				F 026 003 518	22,19	0 204 124 136 ⁶
			09.95-05.99	66-68	Org.Nr. →8206		0 204 123 182	23,8	
							F 026 003 518	22,19	0 204 124 136 ⁶
			06.99-05.00	66-68	Org.Nr. 8207→		0 204 123 182	23,8	
							F 026 003 516	23,8	
							F 026 003 518	22,19	
	2.0 HDi	ABO	10.99-01.07	70/80/81			F 026 003 517	23,8	
		ABS	10.99-01.07	70/80/81			F 026 003 516	23,8	
	2.0 i 16V	ABO	03.00-01.07	100			F 026 003 517	23,8	
		ABS	03.00-01.07	100			F 026 003 516	23,8	
	1.6 i		09.95-01.07	51/52/58/		FCC,LLE	0 204 125 714		
	1.8 i			66-68/70/		FCC,LLE BSY	0 204 125 715		
	1.9 D, D Turbo			80/81/100		RLE	0 204 125 109		
	2.0 HDi, i 16V								
	1.6 i		09.95→	51/52/58/			0 204 131 085 ¹⁰		
	1.8 i			66-68/70/					
	1.9 D, D Turbo			80/81/100					
	2.0 HDi, i 16V								
	1.6 i		09.95-01.07	51/52/58/		FKR	1 987 477 565	500	
	1.8 i			66-68/70/		FLR	1 987 477 774	900	
	1.9 D			80/81/100		LLE	1 987 477 568	← 1063	
	1.9 D Turbo						1 987 477 569	→ 2286	
	2.0 HDi					RLE	1 987 477 568	← 1063	
	2.0 i 16V						1 987 477 773	→ 2368	
	1.6 i		06.97-12.99	51/58/70	Org.Nr. 7481→8420		0 265 216 496 ¹¹		
	1.8 i		01.00-01.07	51/58/70	Org.Nr. 8421→		0 265 216 725 ¹¹		
	1.9 D								
	1.9 D		09.01-01.07	52			0 265 216 725 ¹¹		





PEUGEOT Expert [U64]						
1.9 D Turbo	06.97-07.98	68	Org.Nr. 7481→		0 265	216 496 ¹¹
	06.97-12.99	66-68	Org.Nr. 7481→8420		0 265	216 496 ¹¹
	01.00-05.00	66-68	Org.Nr. 8421→		0 265	216 725 ¹¹
2.0 HDi	10.99-12.99	70/80	Org.Nr. 7481→8420		0 265	216 496 ¹¹
	01.00-01.07	70/80	Org.Nr. 8421→		0 265	216 725 ¹¹
2.0 HDi, i 16V	03.00-01.07	81/100			0 265	216 725 ¹¹
1.6 i	06.97-09.97	58	Org.Nr. 7481→7601		0 265	006 426 ⁴
	06.97-05.00	58	Org.Nr. 7481→		0 265	006 388 ³
	10.97-05.00	58	Org.Nr. 7602→		0 265	006 504 ⁴
1.8 i	06.97-09.97	70	Org.Nr. 7481→7601		0 265	006 426 ⁴
	06.97-08.01	70	Org.Nr. 7481→9050		0 265	006 388 ³
	10.97-08.01	70	Org.Nr. 7602→9050		0 265	006 504 ⁴
	09.01-01.07	70	Org.Nr. 9051→		0 265	006 730 ³
1.9 D					0 265	006 731 ⁴
	06.97-09.97	51	Org.Nr. 7481→7601		0 265	006 426 ⁴
	06.97-05.00	51	Org.Nr. 7481→		0 265	006 388 ³
	10.97-05.00	51	Org.Nr. 7602→		0 265	006 504 ⁴
	06.98-08.01	51			0 265	006 388 ³
1.9 D Turbo	06.97-09.97	66-68	Org.Nr. 7481→7601		0 265	006 426 ⁴
	06.97-05.00	66-68	Org.Nr. 7481→		0 265	006 388 ³
2.0 HDi	10.99-08.01	70/80/81/	Org.Nr. →9050		0 265	006 388 ³
		100			0 265	006 504 ⁴
2.0 i 16V	09.01-01.07	70/80/81/	Org.Nr. 9051→		0 265	006 730 ³
		100			0 265	006 731 ⁴

J 5

1.9 D, D Turbo	07.87-12.93	51/60/62/		ABM	1 987	476 462	435
	2.0	70/72			1 987	476 463	435
	2.5 D Turbo						
1.9 D	11.87-12.93	51		CSA,L02	0 986	473 778	↻ ← 43
				L02	0 986	473 779	↻ → 43
			Fg.Nr. 0154462→	L03	0 986	473 776	↻ ← 38
					0 986	473 777	↻ → 38
1.9 D Turbo	08.92-12.93	60		CSA	0 986	473 778	↻ → 43
2.0	07.87-12.93	62/72		CSA,L02	0 986	473 778	↻ ← 43
				L02	0 986	473 779	↻ → 43
			Fg.Nr. 0154462→	L03	0 986	473 776	↻ ← 38
					0 986	473 777	↻ → 38
2.5 D Turbo	07.87-12.93	70		CSA	0 986	473 779	↻ → 43
					0 986	473 778	↻ ← 43
1.9 D, D Turbo	07.87-12.93	51/60/62/		L27	1 987	476 244 ¹	265
	2.0	70/72		L30	1 987	476 688 ¹	290
	2.5 D Turbo			L32	1 987	476 689 ¹	335
1.9 D, D Turbo	07.87-12.93	51/60/62/	Fg.Nr. S77160→		0 986	475 420	↔ 25,4
	2.0	70/72		L01	0 986	475 056	↔ 22,19
	2.5 D Turbo			L02	0 986	475 612	↔ 27

		S							
	1.9 D 2.0 2.5 D Turbo	07.87-12.93	51/62/70/ 72				F 026 003 150	22,19	
	1.8	07.90-12.93	49-51		L03,RLE		0 204 125 421 ²⁵		
				Fg.Nr. S 273004→	AS2,L03		0 204 125 420 ²⁵		
		10.90-12.93	49-51		L02		0 204 125 550 ²⁵		
	1.9 D	11.87-09.90	51		L02		0 204 125 345 ²⁵		
		11.87-12.93	51				0 204 125 328		
				Fg.Nr. →S 476623	L02,RLE		0 204 125 345 ²⁵		
		07.90-12.93	51		L03,RLE		0 204 125 421 ²⁵		
				Fg.Nr. S 273004→	AS2,L03		0 204 125 420 ²⁵		
		10.90-12.93	51		L02		0 204 125 550 ²⁵		
	1.9 D Turbo	08.92-12.93	60				0 204 125 550 ²⁵		
	2.0	07.87-09.90	62/72		L02		0 204 125 345 ²⁵		
					L03		0 204 125 298		
		07.87-12.93	62/72		L03		0 204 125 328		
				Fg.Nr. →S 476623	L02,RLE		0 204 125 345 ²⁵		
		07.90-12.93	55-63		L03,RLE		0 204 125 421 ²⁵		
				Fg.Nr. S 273004→	AS2,L03		0 204 125 420 ²⁵		
			62/72		L03,RLE		0 204 125 421 ²⁵		
				Fg.Nr. S 273004→	AS2,L03		0 204 125 420 ²⁵		
		10.90-12.93	55-63		L02		0 204 125 550 ²⁵		
			62/72		L02		0 204 125 550 ²⁵		
	2.5 D	07.90-12.93	54-55		L03,RLE		0 204 125 421 ²⁵		
				Fg.Nr. S 273004→	AS2,L03		0 204 125 420 ²⁵		
		10.90-12.93	54-55		L02		0 204 125 550 ²⁵		
	2.5 D Turbo	07.87-09.90	70				0 204 125 345 ²⁵		
		07.87-12.93	70		AA		0 204 125 550 ²⁵		
		10.90-12.93	70				0 204 125 550 ²⁵		
	1.9 D, D Turbo 2.0 2.5 D Turbo	07.87-12.93	51/60/62/ 70/72				0 204 131 226		
	1.9 D 1.9 D Turbo 2.0 2.5 D Turbo	07.87-12.93	51/60/62/ 70/72		FLR,LLE FLR,RLE LLE RLE		1 987 477 419 1 987 477 421 1 987 477 417 1 987 477 420	2338 2377 1608 1642	
J 9									
	1.6 2.0 2.1 D 2.5 D	10.85-06.87	41/43/53/ 55				F 026 002 088	↔ 28,5	





Partner



	1.6 i 16V	02.04 →	81		INB BO	0 204 102 971	← 54	
						0 204 103 971	↻	
							0 204 102 972	→ 54
							0 204 103 972	↻
							LUC 0 986 473 026	↻ ← 54
							0 986 474 026	↻ → 54
							INB 0 986 473 025	↻ ← 54
							0 986 474 025	↻ → 54
							0 204 102 971	← 54
							0 204 103 971	↻
						0 204 102 972	→ 54	
						0 204 103 972	↻	
						LUC 0 986 473 026	↻ ← 54	
						0 986 474 026	↻ → 54	
						INB 0 986 473 025	↻ ← 54	
						0 986 474 025	↻ → 54	



	1.6 i 16V	ABO 02.04 →	81	Org.Nr. 8610 →	0 204 123 373	23,8
		ABS 02.04 →	81	Org.Nr. 8610 →	0 204 123 350	23,8
	1.8 i	ABO 10.99-12.03	66		0 204 123 373	23,8
		07.00-12.03	66	Org.Nr. 8610 →	0 204 123 373	23,8
		ABS 10.99-12.03	66		0 204 123 350	23,8
		07.00-12.03	66	Org.Nr. 8610 →	0 204 123 350	23,8

	1.6 i 16V	02.04 →	81	Org.Nr. 8610 →	BO	0 204 125 764
	1.8 i	07.00-12.03	66	Org.Nr. 8610 →	BO	0 204 125 764

	1.6 i 16V	02.04 →	81		FEN,KOB	0 986 482 029 ¹⁰
	1.8 i	10.99-12.03	66		FEN,KOB	0 986 482 029 ¹⁰

	1.6 i 16V	02.04 →	81			0 265 216 721 ¹¹
	1.8 i	10.99-12.03	66			0 265 216 721 ¹¹
	2.0 HDi	10.00 →	66			0 265 216 484 ¹¹

	1.6 i 16V	02.04 →	81		TEI	0 273 004 112 ¹⁶
	1.8 i	10.99-12.03	66		TEI	0 273 004 112 ¹⁶

	1.6 i 16V	02.04 →	81			0 265 006 200 ³	
						0 265 006 659 ⁴	
	1.8 i	10.99-12.03	66				0 265 006 200 ³
							0 265 006 659 ⁴
	2.0 HDi	10.00 →	66			LAB BO	0 265 006 201 ³
							LIM,SBR
RAB BO							0 265 006 200 ³

Partner [B9]



	1.6 HDi	05.08 →	55/66/80			1987 481 051	450
	1.6 i 16V						













	1.6 HDi 1.6 i16V	05.08→	55/66/80				1 987 481 052	237
	1.6 HDi 1.6 i16V	05.08-11.08	55/66/80	Org.Nr. →11682			0 265 231 975 ¹¹ 0 265 235 362 ²⁶	
	1.6 HDi 1.6 i16V	05.08→	55/66/80				0 265 007 788 ³ 0 265 007 789 ⁴	
	1.6 HDi 1.6 i16V	05.08-11.08	55/66/80	Org.Nr. →11682			0 265 005 715	

Partner [M4]

	Electrique 1.1 i 1.4, i 1.6 i16V 1.8 D, i 1.9 D 2.0 HDi	07.96-08.02	24/43-44/ 50/51-52/ 55/66/80				1 987 476 651	440
	Electrique 1.1 i 1.4 1.4 i	07.96-08.02	24/44/ 51-52/55		INB	BO	0 204 102 971 0 204 103 971 0 204 102 972 0 204 103 972	← 54 ↻ → 54 ↻
						LUC	0 986 473 026 0 986 474 026	↻ ← 54 ↻ → 54
					INB		0 986 473 025 0 986 474 025	↻ ← 54 ↻ → 54
	1.6 i16V	09.00-08.02	80		INB	BO	0 204 102 971 0 204 103 971 0 204 102 972 0 204 103 972	← 54 ↻ → 54 ↻
						LUC	0 986 473 026 0 986 474 026	↻ ← 54 ↻ → 54
	1.8 D	07.96-08.02	43-44		INB	BO	0 204 102 971 0 204 103 971 0 204 102 972 0 204 103 972	← 54 ↻ → 54 ↻
						LUC	0 986 473 026 0 986 474 026	↻ ← 54 ↻ → 54
					INB		0 986 473 025 0 986 474 025	↻ ← 54 ↻ → 54
	1.8 i	03.97-08.02	66		INB	BO	0 204 102 971 0 204 103 971 0 204 102 972 0 204 103 972	← 54 ↻ → 54 ↻
						LUC	0 986 473 026 0 986 474 026	↻ ← 54 ↻ → 54



◀ PEUGEOT Partner [M4]																											
1.9D	07.96-08.02	50/51	INB	BO	0 204 102 971	← 54																					
					0 204 103 971																						
					0 204 102 972	→ 54																					
					0 204 103 972																						
					LUC	0 986 473 026	← 54																				
						0 986 474 026	→ 54																				
					INB	0 986 473 025	← 54																				
						0 986 474 025	→ 54																				
					09.00-08.02	52	INB	BO	0 204 102 971	← 54																	
									0 204 103 971																		
0 204 102 972	→ 54																										
0 204 103 972																											
LUC	0 986 473 026	← 54																									
	0 986 474 026	→ 54																									
2.0 HDi	12.99-08.02	66	INB	BO	0 204 102 971	← 54																					
					0 204 103 971																						
					0 204 102 972	→ 54																					
					0 204 103 972																						
					LUC	0 986 473 026	← 54																				
						0 986 474 026	→ 54																				
INB	0 986 473 025	← 54																									
	0 986 474 025	→ 54																									
	Electrique	07.96-08.02	24/43-44/ 50/51-52/ 55/66/80			1 987 476 178	280																				
											1.1 i																
											1.4, i																
											1.6 i 16V																
											1.8 D, i																
											1.9 D																
											2.0 HDi																
	Electrique	07.96-08.02	24/43-44/ 50/51-52/ 55/66/80			0 986 475 836	↔ 22,19																				
											1.1 i																
											1.4, i																
											1.6 i 16V																
											1.8 D, i																
											1.9 D																
											2.0 HDi																
	Electrique	ABO	01.98-06.00	24	Org.Nr. →8609			F 026 003 190	23,8																		
											07.00-08.02	24	Org.Nr. 8610→	0 204 123 373	23,8												
											ABS	01.98-06.00	24	Org.Nr. →8609	LLE	F 026 003 192	23,8										
															RLE	0 204 123 341	23,8										
											07.00-08.02	24	Org.Nr. 8610→	0 204 123 350	23,8												
											1.1 i	ABO	07.96-06.00	44	Org.Nr. →8609			F 026 003 190	23,8								
																					07.00-08.02	44	Org.Nr. 8610→	0 204 123 373	23,8		
																					09.00-08.02	44		0 204 123 373	23,8		
																					ABS	07.96-06.00	44	Org.Nr. →8609	LLE	F 026 003 192	23,8
																									RLE	0 204 123 341	23,8
																					07.00-08.02	44	Org.Nr. 8610→	0 204 123 350	23,8		
											09.00-08.02	44		0 204 123 350	23,8												
											1.4	ABO	11.96-06.00	51-52	Org.Nr. →8609			F 026 003 190	23,8								
																					07.00-08.02	51-52	Org.Nr. 8610→	0 204 123 373	23,8		
																					ABS	11.96-06.00	51-52	Org.Nr. →8609	LLE	F 026 003 192	23,8
																									RLE	0 204 123 341	23,8
																					07.00-08.02	51-52	Org.Nr. 8610→	0 204 123 350	23,8		

		S								
1.4i	ABO	07.96-06.00	55	Org.Nr. →8609			F 026 003 190	23,8		
		07.00-08.02	55	Org.Nr. 8610→			0 204 123 373	23,8		
		09.00-08.02	55				0 204 123 373	23,8		
	ABS	07.96-06.00	55	Org.Nr. →8609	LLE		F 026 003 192	23,8		
					RLE		0 204 123 341	23,8		
			07.00-08.02	55	Org.Nr. 8610→			0 204 123 350	23,8	
		09.00-08.02	55				0 204 123 350	23,8		
1.6i 16V	ABO	09.00-08.02	80				0 204 123 373	23,8		
	ABS	09.00-08.02	80				0 204 123 350	23,8		
1.8D	ABO	07.96-06.00	43-44/66	Org.Nr. →8609			F 026 003 190	23,8		
1.8i		07.00-08.02	43-44/66	Org.Nr. 8610→			0 204 123 373	23,8		
	ABS	07.96-06.00	43-44/66	Org.Nr. →8609	LLE		F 026 003 192	23,8		
					RLE		0 204 123 341	23,8		
		07.00-08.02	43-44/66	Org.Nr. 8610→			0 204 123 350	23,8		
1.9D	ABO	07.96-06.00	50/51	Org.Nr. →8609			F 026 003 190	23,8		
		07.00-08.02	50/51	Org.Nr. 8610→			0 204 123 373	23,8		
		09.00-08.02	52				0 204 123 373	23,8		
	ABS	07.96-06.00	50/51	Org.Nr. →8609	LLE		F 026 003 192	23,8		
					RLE		0 204 123 341	23,8		
			07.00-08.02	50/51	Org.Nr. 8610→			0 204 123 350	23,8	
		09.00-08.02	52				0 204 123 350	23,8		
2.0 HDi	ABO	12.99-08.02	66				0 204 123 373	23,8		
	ABS	12.99-08.02	66				0 204 123 350	23,8		
	Electrique	01.98-06.00	24	Org.Nr. →8609			0 204 125 134			
		07.00-08.02	24	Org.Nr. 8610→		BO	0 204 125 764			
	1.1i		07.96-06.00	44	Org.Nr. →8609			0 204 125 134		
			07.00-08.02	44	Org.Nr. 8610→		BO	0 204 125 764		
			09.00-08.02	44			BO	0 204 125 764		
	1.4		11.96-06.00	51-52	Org.Nr. →8609			0 204 125 134		
			07.00-08.02	51-52	Org.Nr. 8610→		BO	0 204 125 764		
	1.4i		07.96-06.00	55	Org.Nr. →8609			0 204 125 134		
			07.00-08.02	55	Org.Nr. 8610→		BO	0 204 125 764		
			09.00-08.02	55			BO	0 204 125 764		
	1.6i 16V		09.00-08.02	80			BO	0 204 125 764		
	1.8D		07.96-06.00	43-44/50/	Org.Nr. →8609			0 204 125 134		
	1.8i			51/66						
	1.9D		07.00-08.02	43-44/50/	Org.Nr. 8610→		BO	0 204 125 764		
				51/66						
	1.9D		09.00-08.02	52			BO	0 204 125 764		
2.0 HDi		12.99-08.02	66				0 204 125 514			
	1.1i	07.96-08.02	43-44/50/		FEN,KOB		0 986 482 029 ¹⁰			
	1.4, i		51-52/55/							
	1.6i 16V		66/80							
	1.8D, i									
	1.9D									
	2.0 HDi									
	1.1i	07.96-11.99	44	Org.Nr. →8393			1 987 477 576	← 1745		
							1 987 477 577	→ 1818		
		12.99-08.02	44	Org.Nr. 8394→			1 987 477 576	← 1745		
							1 987 477 595	→ 1850		
		09.00-08.02	44				1 987 477 576	← 1745		
						1 987 477 595	→ 1850			
	1.4	11.96-11.99	51-52	Org.Nr. →8393			1 987 477 576	← 1745		
							1 987 477 577	→ 1818		
		12.99-08.02	51-52	Org.Nr. 8394→			1 987 477 576	← 1745		
							1 987 477 595	→ 1850		
						1 987 477 576	← 1745			



PEUGEOT Partner [M4]						
1.4 i	07.96-11.99	55	Org.Nr. →8393	1987	477 576	← 1745
	12.99-08.02	55	Org.Nr. 8394→	1987	477 577	→ 1818
1.6 i 16V	09.00-08.02	80		1987	477 576	← 1745
				1987	477 595	→ 1850
1.8 D	07.96-11.99	43-44/50/	Org.Nr. →8393	1987	477 576	← 1745
		51/66		1987	477 577	→ 1818
1.9 D	12.99-08.02	43-44/50/	Org.Nr. 8394→	1987	477 576	← 1745
		51/66		1987	477 595	→ 1850
1.9 D	12.99-08.02	52/66		1987	477 576	← 1745
				1987	477 595	→ 1850
2.0 HDi				1987	477 595	→ 1850

	Electrique	07.96-08.02	24/43-44/		0 265	216 721 ¹¹
	1.1 i		50/51-52/			
	1.4, i		55/66/80			
	1.6 i 16V					
	1.8 D, i					
	1.9 D					
2.0 HDi						



















	Electrique	07.96-08.02	24/43-44/	TEI	0 273	004 112 ¹⁶
	1.1 i		50/51-52/			
	1.4, i		55/66/80			
	1.6 i 16V					
	1.8 D, i					
	1.9 D					
2.0 HDi						

	Electrique	07.96-05.01	24/43-44/	Org.Nr. →8938	0 265	006 209 ⁴
	1.1 i		50/51-52/			
	1.4, i		55/66/80			
	1.6 i 16V	07.96-08.02	24/43-44/50/51-52/55/66/80		0 265	006 200 ³
	1.8 D, i	06.01-08.02	24/43-44/	Org.Nr. 8939→	0 265	006 659 ⁴
	1.9 D		50/51-52/			
2.0 HDi		55/66/80				

Partner [M5]

	1.1 i	09.02-04.08	44/55		1987	476 651	440
	1.4 i						
	1.6 HDi	ESP 09.02-04.08	66/80		1987	476 785	455
	1.6 i 16V	OFD 09.02-04.08	66/80		1987	476 651	440
	1.9 D	09.02-03.07	52		1987	476 651	440
	2.0 HDi	ESP 09.02-07.06	66		1987	476 785	455
OFD 09.02-07.06		66		1987	476 651	440	

	1.1 i	09.02→	44/55		0 204	102 971	← 54
	1.4 i				0 204	103 971	↻
	1.6 HDi				0 204	102 972	→ 54
					0 204	103 972	↻
	1.6 HDi	OFD 09.02→	66/80		0 204	102 971	← 54
	1.6 i 16V				0 204	103 971	↻
				0 204	102 972	→ 54	
				0 204	103 972	↻	

		S							
1.9D		09.02→	52				0 204 102 971 0 204 103 971	← 54 	
							0 204 102 972 0 204 103 972	→ 54 	
2.0 HDi		OFD 09.02→	66				0 204 102 971 0 204 103 971	← 54 	
							0 204 102 972 0 204 103 972	→ 54 	
									
	1.1 i 1.4 i 1.6 HDi, i 16V 1.9 D 2.0 HDi	09.02-04.08	44/52/55/ 66/80				1 987 476 178	280	
	1.1 i 1.4 i 1.6 HDi, i 16V 1.9 D 2.0 HDi	09.02→	44/52/55/ 66/80				0 986 475 836	↔ 22,19	
									
	1.1 i 1.4 i 1.6 HDi 1.6 i 16V 1.9 D 2.0 HDi	ABO 09.02-04.08 ABS 09.02-04.08 ABO 09.02-04.08 ABS 09.02-04.08 ESP 09.02-04.08	44/55 44/55 66/80 66/80 66/80				0 204 123 373 0 204 123 350 0 204 123 373 0 204 123 350 0 204 123 644 0 204 123 645	23,8 23,8 23,8 23,8 23,8 23,8	
						LLE RLE	0 204 123 644 0 204 123 645	23,8 23,8	
		ABO 09.02-03.07 ABS 09.02-03.07	52 52				0 204 123 373 0 204 123 350	23,8 23,8	
		ABO 09.02-07.06 ABS 09.02-07.06 ESP 09.02-07.06	66 66 66				0 204 123 373 0 204 123 350 0 204 123 644 0 204 123 645	23,8 23,8 23,8 23,8	
						LLE RLE	0 204 123 644 0 204 123 645	23,8 23,8	
	1.1 i 1.4 i 1.6 HDi 1.6 i 16V 1.9 D 2.0 HDi	09.02-03.04 09.02-10.05 04.04-10.05 09.02-03.04 09.02-04.08 04.04-04.08 09.05-04.08 09.02-03.04 09.02-04.08 04.04-04.08 09.02-03.04 09.02-03.07 04.04-03.07	44 44 44 55 55 55 55 52/66/80 52/66/80 52/66/80 52/66/80 52/66/80 52/66/80 52/66/80	Org.Nr. →9974 Org.Nr. 9975→ Org.Nr. →9974 Org.Nr. 9975→		RLE LLE RLE RLE LLE RLE RLE LLE RLE LLE RLE	0 204 125 805 0 204 125 804 0 204 125 804 0 204 125 805 0 204 125 804 0 204 125 804 0 204 125 804 0 204 125 805 0 204 125 804 0 204 125 804 0 204 125 805 0 204 125 804 0 204 125 804		
	1.1 i 1.4 i 1.6 i 16V 1.9 D 2.0 HDi	09.02→	44/52/55/ 66/80			FEN,KOB	0 986 482 029 ¹⁰		





◀ PEUGEOT Partner [M5]

	1.1 i	09.02-04.08	44/55		1987 477 576	← 1745
	1.4 i				1987 477 595	→ 1850
	1.6 HDi	09.02-04.08	66/80	SBR	1987 482 116	← 600
				TBR	1987 482 117	→ 1627
	1.6 i 16V			TBR	1987 477 576	← 1745
					1987 477 595	→ 1850
1.9 D	09.02-03.07	52		1987 477 576	← 1745	
2.0 HDi	09.02-07.06	66		SBR	1987 482 116	← 600
				TBR	1987 482 117	→ 1627
					1987 477 576	← 1745
					1987 477 595	→ 1850

	1.1 i	09.02-11.04	44	Org.Nr. →10220	0 265 216 721 ¹¹	
		12.04-10.05	44	Org.Nr. 10221→	0 265 231 523 ¹¹	
	1.4 i	09.02-11.04	55	Org.Nr. →10220	0 265 216 721 ¹¹	
		12.04-12.07	55	Org.Nr. 10221→11346	0 265 231 523 ¹¹	
1.6 HDi	09.05-12.07	55	66	Org.Nr. →11346	0 265 231 523 ¹¹	
				Org.Nr. →11346	0 265 231 523 ¹¹	
					0 265 234 061 ²⁶	
1.6 i 16V	09.02-11.04	80		Org.Nr. →10220	0 265 216 721 ¹¹	
					0 265 225 130 ²⁶	
				12.04-12.07	80	Org.Nr. 10221→11346
					0 265 234 061 ²⁶	
1.9 D	09.02-11.04	52		Org.Nr. →10220	0 265 216 721 ¹¹	
				12.04-03.07	52	Org.Nr. 10221→
2.0 HDi	09.02-11.04	66		Org.Nr. →10220	0 265 216 721 ¹¹	
					0 265 225 130 ²⁶	
				12.04-07.06	66	Org.Nr. 10221→
					0 265 234 061 ²⁶	

	1.1 i	09.02-02.03	44	Org.Nr. →9582	0 265 006 659 ⁴		
		09.02-11.04	44	Org.Nr. →10220	0 265 006 200 ³		
		03.03-11.04	44	Org.Nr. 9583→10220	0 265 006 793 ⁴		
		12.04-07.05	44	Org.Nr. 10221→10478	RAB	0 265 007 667 ⁴	
		12.04-10.05	44	Org.Nr. 10221→		0 265 007 666 ³	
					LAB	0 265 007 668 ⁴	
		08.05-10.05	44	Org.Nr. 10479→	RAB	0 265 007 883 ⁴	
		1.4 i	09.02-02.03	55	Org.Nr. →9582	0 265 006 659 ⁴	
			09.02-11.04	55	Org.Nr. →10220	0 265 006 200 ³	
			03.03-11.04	55	Org.Nr. 9583→10220	0 265 006 793 ⁴	
12.04-07.05	55		Org.Nr. 10221→10478	RAB	0 265 007 667 ⁴		
12.04-04.08	55		Org.Nr. 10221→		0 265 007 666 ³		
			LAB	0 265 007 668 ⁴			
	08.05-04.08	55	Org.Nr. 10479→	RAB	0 265 007 883 ⁴		
1.6 HDi	09.05-04.08	55	66		0 265 007 666 ³		
					0 265 007 666 ³		
					LAB	0 265 007 668 ⁴	
				RAB	0 265 007 883 ⁴		
1.6 i 16V	09.02-02.03	80		Org.Nr. →9582	0 265 006 659 ⁴		
				09.02-11.04	80	Org.Nr. →10220	0 265 006 200 ³
					SBR	0 265 006 732 ⁴	
	03.03-11.04	80	Org.Nr. 9583→10220	STB	0 265 006 793 ⁴		
	12.04-07.05	80	Org.Nr. 10221→10478	RAB	0 265 007 667 ⁴		
	12.04-04.08	80	Org.Nr. 10221→		0 265 007 666 ³		
				LAB	0 265 007 668 ⁴		
		08.05-04.08	80	Org.Nr. 10479→	RAB	0 265 007 883 ⁴	

		S							
1.9D		09.02-02.03	52	Org.Nr. →9582			0 265 006 659 ⁴		
		09.02-11.04	52	Org.Nr. →10220			0 265 006 200 ³		
		03.03-11.04	52	Org.Nr. 9583→10220			0 265 006 793 ⁴		
		12.04-07.05	52	Org.Nr. 10221→10478	RAB		0 265 007 667 ⁴		
		12.04-03.07	52	Org.Nr. 10221→			0 265 007 666 ³		
						LAB	0 265 007 668 ⁴		
2.0 HDi		08.05-03.07	52	Org.Nr. 10479→	RAB		0 265 007 883 ⁴		
		09.02-02.03	66	Org.Nr. →9582	STB		0 265 006 659 ⁴		
		09.02-11.04	66	Org.Nr. →10220			0 265 006 200 ³		
						SBR	0 265 006 732 ⁴		
		03.03-11.04	66	Org.Nr. 9583→10220	STB		0 265 006 793 ⁴		
		12.04-07.05	66	Org.Nr. 10221→10478	RAB		0 265 007 667 ⁴		
	12.04-07.06	66	Org.Nr. 10221→			0 265 007 666 ³			
					LAB	0 265 007 668 ⁴			
	08.05-07.06	66	Org.Nr. 10479→	RAB		0 265 007 883 ⁴			
	1.6 HDi	09.02-12.07	66/80	Org.Nr. →11346			0 265 005 290		
	1.6 i16V	01.08-04.08	66/80	Org.Nr. 11347→			0 265 005 758		
	2.0 HDi	09.02-07.06	66				0 265 005 290		

Ranch [M4]

	1.4i		07.97→	51/55			1 987 476 651		440
	1.9D								
	1.4i		07.97→	51/55	INB	BO	0 204 102 971		← 54
	1.9D						0 204 103 971		↻
							0 204 102 972		→ 54
							0 204 103 972		↻
						LUC	0 986 473 026		↻ ← 54
						0 986 474 026		↻ → 54	
				INB	0 986 473 025		↻ ← 54		
					0 986 474 025		↻ → 54		
	1.4i		07.97→	51/55			1 987 476 178		280
	1.9D								
	1.4i		07.97→	51/55			0 986 475 836		↔ 22,19
	1.9D								
	1.4i	ABO	07.97-06.00	55	Org.Nr. →8609		F 026 003 190		23,8
			07.00→	55	Org.Nr. 8610→		0 204 123 373		23,8
		ABS	07.97-06.00	55	Org.Nr. →8609	LLE	F 026 003 192		23,8
						RLE	0 204 123 341		23,8
			07.00→	55	Org.Nr. 8610→		0 204 123 350		23,8
		1.9D	ABO	07.97-10.98	51		F 026 003 190		23,8
	11.98-06.00			51	Org.Nr. →8609		F 026 003 190		23,8
	07.00→			51	Org.Nr. 8610→		0 204 123 373		23,8
	ABS		07.97-10.98	51		LLE	F 026 003 192		23,8
						RLE	0 204 123 341		23,8
						11.98-06.00	51	Org.Nr. →8609	LLE
		07.00→	51	Org.Nr. 8610→	RLE	0 204 123 341		23,8	





◀ PEUGEOT Ranch [M4]

	1.4 i	07.97-06.00	55	Org.Nr. →8609		0 204 125 134			
		07.00→	55	Org.Nr. 8610→	BO	0 204 125 764			
	1.9 D	07.97-10.98	51			0 204 125 134			
		11.98-06.00	51	Org.Nr. →8609		0 204 125 134			
		07.00→	51	Org.Nr. 8610→	BO	0 204 125 764			
	1.4 i	07.97→	51/55		FEN,KOB	0 986 482 029 ¹⁰			
	1.9 D								
	1.4 i	07.97-11.99	55	Org.Nr. →8393		1 987 477 576	← 1745		
						1 987 477 577	→ 1818		
		12.99→	55	Org.Nr. 8394→		1 987 477 576	← 1745		
						1 987 477 595	→ 1850		
	1.9 D	07.97-10.98	51			1 987 477 576	← 1745		
						1 987 477 577	→ 1818		
		11.98-11.99	51	Org.Nr. →8393		1 987 477 576	← 1745		
						1 987 477 577	→ 1818		
		12.99→	51	Org.Nr. 8394→		1 987 477 576	← 1745		
						1 987 477 595	→ 1850		
	1.4 i	07.97→	51/55			0 265 216 721 ¹¹			
	1.9 D								
	1.4 i	07.97→	51/55		TEI	0 273 004 112 ¹⁶			
	1.9 D								
	1.4 i	07.97-05.01	55	Org.Nr. →8938		0 265 006 209 ⁴			
			07.97→	55			0 265 006 200 ³		
			06.01→	55	Org.Nr. 8939→		0 265 006 659 ⁴		
	1.9 D	07.97-10.98	51				0 265 006 209 ⁴		
			07.97→	51			0 265 006 200 ³		
			11.98-05.01	51	Org.Nr. →8938		0 265 006 209 ⁴		
				06.01→	51	Org.Nr. 8939→		0 265 006 659 ⁴	
								0 265 006 659 ⁴	

205 Pickup



	1.1	05.85-09.98	40/44		35L	1 987 476 519	355			
	1.8 D				435	1 987 476 521	435			
	1.1	05.85-09.98	40/44			LUC	0 986 471 672	← 48		
							0 986 473 672	↻		
							0 986 472 672	→ 48		
							0 986 474 672	↻		
	1.8 D	05.85-09.98	40/44			TW	BSY	0 204 102 226	← 48	0 204 100 098 ⁸
								0 986 473 100	↻	0 204 104 039 ⁷
								0 204 102 227	→ 48	0 204 100 098 ⁸
								0 986 474 100	↻	
								0 204 102 289	← 48	0 204 100 098 ⁸
								0 986 473 103	↻	0 204 104 039 ⁷
		0 204 102 290	→ 48	0 204 100 098 ⁸						
		0 986 474 103	↻							



	1.1	10.87-12.90	40		L26		1 987 476 522 ¹	260
					27L		1 987 476 523 ¹	276
	1.8D	05.85-09.98	44		L26		1 987 476 522 ¹	260
					27L		1 987 476 523 ¹	276
					35L		1 987 476 519 ¹	355

	1.1	10.87-12.90	40		LUC		F 026 002 520	← 19,05
							F 026 002 521	→ 19,05
					BKV	BSY	F 026 002 204	← 19
							F 026 002 205	→ 19
					BKV	BSY	F 026 002 216	← 20,6
							F 026 002 217	→ 20,6
	1.8D	05.85-09.98	44		LUC		F 026 002 520	← 19,05
							F 026 002 521	→ 19,05
					BKV	BSY	F 026 002 204	← 19
							F 026 002 205	→ 19
					LWG	LUC	0 986 475 428	↔ 20,6
					BKV	BSY	F 026 002 216	← 20,6
							F 026 002 217	→ 20,6

	1.1	10.87-10.90	40		BKV		0 204 123 094	17,5
		10.87-12.90	40		AS4		F 026 003 103	19
		10.87-10.90	40	ABO	AS3	BSY	F 026 003 075	19
		10.87-12.90	40		AS4	ATE	F 026 003 243	20,6
						BSY	F 026 003 180	20,6
	1.8D	05.85-10.90	44		BKV		0 204 123 094	17,5
		05.85-09.98	44		AS4		F 026 003 103	19
		05.85-10.90	44	ABO	AS3	BSY	F 026 003 075	19
		05.85-09.98	44		AS4	ATE	F 026 003 243	20,6
						BSY	F 026 003 180	20,6
							0 204 124 069 ⁶	0 204 124 069 ⁶
		10.90-09.98	44	ABS	RLE		0 204 123 172	20,6
							0 204 124 064 ⁶	0 204 124 064 ⁶

	1.1	ABO	05.85-09.98	40/44			0 204 125 058	
	1.8D	ABS	05.85-09.98	40/44			0 204 125 134	

	1.1	10.87-12.90	40		LWG		0 204 131 086 ¹⁰	
		10.87-12.90	40	ABS			0 204 131 052 ¹⁰	
	1.8D	05.85-09.98	44	ABS			0 204 131 052 ¹⁰	

	1.1	05.85-09.98	40/44		TBR		1 987 477 144	← 1396
	1.8D						1 987 477 145	→ 1411

504 Pickup

	2.5D	07.87-12.89	55	Fg.Nr. S 3.610.001→	LWG	LUC	0 986 475 512	↔ 22,19

	2.5D	07.87-12.89	55	Fg.Nr. S 3.610.001→	LLE,ZBR		F 026 003 064	20,6
					RLE,ZBR		0 204 123 056	20,6





◀ PEUGEOT 504 Pickup

	2.5 D	07.87-12.89	55	Fg.Nr. S 3.610.001→	LWG,RLE	0 204 125 020	
	2.5 D	07.87-12.89	55	Fg.Nr. 1.974.191→		0 204 162 029	

PROTON

Arena



	1.5 i	09.01→	66			1987 482 163	→ 956
--	-------	--------	----	--	--	--------------	-------

RENAULT

Agora



	Citybus	06.95→	144/188/191		LAB	0 265 050 141	
--	---------	--------	-------------	--	-----	---------------	--

Ares



	300 340	04.98→	221/250		LAB	0 265 050 141	
--	------------	--------	---------	--	-----	---------------	--

B



	80 Messenger 90, 4x2, 4x4 110 Messenger 4x2, Messenger 4x4 120 Messenger, Messenger 4x2 120 Messenger 4x4	01.86-06.01	55/56/ 68-71/78/ 85/90				0 204 120 023
--	---	-------------	------------------------------	--	--	--	---------------

CBH



	280 340 350 380	04.86-01.93	208/ 243-247/ 259/275			0 204 162 027	
--	--------------------------	-------------	-----------------------------	--	--	---------------	--





Clio I [X57]

	1.2i 1.4	06.90-02.98	40-41/44/ 55-57			1 987 476 421		240	
	1.2i 1.4	06.90-02.98	40-41/44/ 55-57	INB	BSY	0 204 102 249 0 986 473 101 0 204 102 250 0 986 474 101	← 48 → 48	0 204 100 127 ^B 0 204 104 052 ⁷ 0 204 100 127 ^B	
					LUC	0 986 473 671 0 986 474 671	← 48 → 48		
	1.2i 1.4	06.90-02.98	40-41/44/ 55-57	SBR		1 987 476 708 ²		250	
				TBR		1 987 476 557		288	
	1.2i	ABO 06.90-03.91	40-41		BSY	F 026 002 236 F 026 002 237	→ 20,64 ← 20,64		
					LUC	0 986 475 643 0 986 475 644	▲ ← 20,6 ▲ → 20,6		
		04.91-03.96	40-41		BSY	F 026 002 236 F 026 002 237	← 20,64 → 20,64		
		04.91-02.98	40-41		LUC	0 986 475 643 0 986 475 644	▲ → 20,6 ▲ ← 20,6		
		04.96-02.98	40-41		BSY	F 026 002 236 F 026 002 237	→ 20,64 ← 20,64		
	1.2i 1.4	ABO 01.94-03.96	44/55-57		LUC	0 986 475 643 0 986 475 644	▲ → 20,6 ▲ ← 20,6		
	1.2i 1.4	06.90-02.98	40-41/ 55-57			0 204 102 075 0 204 103 075 0 204 102 077 0 204 103 077	← 30 → 30	0 204 100 062 ^B 0 204 100 062 ^B 0 204 104 068 ⁹	
	1.2i	06.90-02.98	40-41/44	FAH	ATE	F 026 003 103 F 026 003 180 F 026 003 243		19 20,6 20,6	
		ABS 06.90-02.98	40-41	LLE	BSY	0 204 123 176		20,6	
				RLE	BSY	0 204 123 357		19	
	1.4	01.94-03.96	55-57	FAH	ATE	F 026 003 103 F 026 003 180 F 026 003 243		19 20,6 20,6	
	1.2i 1.4	06.90-02.98	40-41/44/ 55-57	TW	BSY	0 204 125 115 0 204 125 153 0 204 125 161			
	1.2i 1.4	06.90-02.98	40-41/44/ 55-57			1 987 477 152		1453	
	1.2i 1.4	06.90-02.98	40-41/44/ 55-57	TEI		2 267 000 704 ¹⁶			



		S				?				
◀RENAULT Clio I [X57]										
	1.2 i	06.90-02.98	40-41				0 265 006 442 ³			
							LAB 0 265 006 443 ⁴			
							RAB 0 265 006 444 ⁴			
	1.2 i	01.94-03.96	44/55-57				LAB 0 265 006 443 ⁴			
	1.4						RAB 0 265 006 444 ⁴			
CLM										
	280	04.86-10.92	208				0 204 162 027			
CLR										
	230	10.90-10.98	166				0 204 162 027			
Express										
	1.9D	07.95-09.02	40				0 986 475 677	↔ 22,19		
Express, Extra, Rapid [F40]										
	Electrique	03.86-10.97	21/27-30/ 33/34/36/ 40/43/44/ 47-48/ 55-59				1 987 476 699	300		
	1.0									
	1.1									
	1.2, i									
	1.4, i									
	1.6D									
	1.9D									
	Electrique	09.94-10.97	21			BSY	0 204 102 249	← 48	0 204 100 127 ⁸	
							0 986 473 101		0 204 104 052 ⁷	
							0 204 102 250	→ 48	0 204 100 127 ⁸	
							0 986 474 101			
	1.0	03.86-05.88	27-30	Fg.Nr. →J029301		BSY	0 204 102 083	← 45	0 204 100 083 ⁸	
							0 204 103 083		0 204 104 044 ⁷	
							0 204 102 085	→ 45	0 204 100 083 ⁸	
							0 204 103 085			
		06.88-08.91	27-30	Fg.Nr. J029302→		BSY	0 204 102 249	← 48	0 204 100 127 ⁸	
							0 986 473 101		0 204 104 052 ⁷	
							0 204 102 250	→ 48	0 204 100 127 ⁸	
							0 986 474 101			
						LUC	0 986 473 671	← 48		
							0 986 474 671	→ 48		



		S							
1.1	03.86-05.88	34	Fg.Nr. →E011000, →J082340	BSY	0 204 102 083	← 45	0 204 100 083 ^B		
					0 204 103 083		0 204 104 044 ⁷		
					0 204 102 085	→ 45	0 204 100 083 ^B		
					0 204 103 085				
	03.86-08.91	34		BSY	0 204 102 249	← 48	0 204 100 127 ^B		
					0 986 473 101		0 204 104 052 ⁷		
					0 204 102 250	→ 48	0 204 100 127 ^B		
					0 986 474 101				
	LUC				0 986 473 671	← 48			
					0 986 474 671	→ 48			
	06.87-05.88	33	Fg.Nr. →E000461, →J0002931	BSY	0 204 102 083	← 45	0 204 100 083 ^B		
					0 204 103 083		0 204 104 044 ⁷		
					0 204 102 085	→ 45	0 204 100 083 ^B		
					0 204 103 085				
	06.88-06.89	34	Fg.Nr. E011001→, J082341→	BSY	0 204 102 250	→ 48	0 204 104 052 ⁷		
					0 986 474 101				
06.88-08.91	33	Fg.Nr. E000462→, J0002932→	BSY	0 204 102 249	← 48	0 204 100 127 ^B			
				0 986 473 101		0 204 104 052 ⁷			
				0 204 102 250	→ 48	0 204 100 127 ^B			
				0 986 474 101					
LUC		Fg.Nr. E00462→, J002932→		0 986 473 671	← 48				
				0 986 474 671	→ 48				
	34	Fg.Nr. E011001→, J082341→	BSY	0 204 102 249	← 48	0 204 100 127 ^B			
				0 986 473 101		0 204 104 052 ⁷			
				0 204 102 250	→ 48	0 204 100 127 ^B			
				0 986 474 101					
LUC				0 986 473 671	← 48				
				0 986 474 671	→ 48				
1.1	03.86-10.97	36/40/43/		BSY	0 204 102 249	← 48	0 204 100 127 ^B		
1.2		44/55-59			0 986 473 101		0 204 104 052 ⁷		
1.2i					0 204 102 250	→ 48	0 204 100 127 ^B		
1.4					0 986 474 101				
1.4i					LUC	0 986 473 671	← 48		
						0 986 474 671	→ 48		
1.6D	03.86-06.86	40			Fg.Nr. →E008444, →J020150	BSY	0 204 102 083	← 45	0 204 100 083 ^B
							0 204 103 083		0 204 104 044 ⁷
							0 204 102 085	→ 45	0 204 100 083 ^B
							0 204 103 085		
03.86-03.97	40		BSY	0 204 102 249	← 48	0 204 100 127 ^B			
				0 986 473 101		0 204 104 052 ⁷			
				0 204 102 250	→ 48	0 204 100 127 ^B			
				0 986 474 101					
LUC				0 986 473 671	← 48				
				0 986 474 671	→ 48				
06.86-03.97	40	Fg.Nr. E008445→, J020151→	BSY	0 204 102 249	← 48	0 204 100 127 ^B			
				0 986 473 101		0 204 104 052 ⁷			
				0 204 102 250	→ 48	0 204 100 127 ^B			
				0 986 474 101					
LUC				0 986 473 671	← 48				
				0 986 474 671	→ 48				
1.9D	09.91-09.97	47-48	BSY	0 204 102 250	→ 48	0 204 104 052 ⁷			
				0 986 474 101					
	09.91-10.97	47-48	BSY	0 204 102 249	← 48	0 204 100 127 ^B			
				0 986 473 101		0 204 104 052 ⁷			
				0 204 102 250	→ 48	0 204 100 127 ^B			
				0 986 474 101					
LUC				0 986 473 671	← 48				
				0 986 474 671	→ 48				
09.94-09.97	40		BSY	0 204 102 249	← 48	0 204 100 127 ^B			
				0 986 473 101		0 204 104 052 ⁷			
				0 204 102 250	→ 48	0 204 100 127 ^B			
				0 986 474 101					















◀ RENAULT Express, Extra, Rapid [F40]













	Electrique	09.94-10.97	21		L28	1987 476 517	332
	1.0	03.86-10.97	27-30/33/		4TO	1987 476 493	270
	1.1		34/36/40				
	1.2, i						
	1.4	03.86-09.96	43		4TO	1987 476 493	270
		09.91-09.96	43		2TO,ERH	1987 476 517	332
		09.91-09.97	43		L28	1987 476 517	332
	1.4, i	03.86-09.97	44		4TO	1987 476 493	270
	1.4 i	09.91-10.97	40/47-48/		2TO,ERH	1987 476 517	332
			55-59		4TO	1987 476 493	270
1.6 D	03.86-10.97	40/47-48/		2TO,ERH	1987 476 517	332	
1.9 D		55-59		4TO	1987 476 493	270	

	Electrique	06.96-10.97	21		LUC	0986 475 677	↔ 22,19	
	1.0	03.86-08.91	27-30/33		BSY	F 026 002 176	← 22,19	
	1.1					F 026 002 177	→ 22,19	
					LUC	0986 475 233	← 22,19	
						0986 475 234	→ 22,19	
	1.1	03.86-08.91	34		BSY	F 026 002 139	← 22	
						F 026 002 140	→ 22	
						F 026 002 176	← 22,19	
						F 026 002 177	→ 22,19	
					LUC	0986 475 233	← 22,19	
						0986 475 234	→ 22,19	
		09.91-09.96	36		BSY	F 026 002 139	← 22	
						F 026 002 140	→ 22	
						F 026 002 176	← 22,19	
						F 026 002 177	→ 22,19	
		09.91-10.97	36		LUC	0986 475 233	← 22,19	
						0986 475 234	→ 22,19	
		10.96-10.97	36		BSY	F 026 002 133	← 20,6	
						F 026 002 134	→ 20,6	
	1.2	09.91-09.96	40		BSY	F 026 002 133	← 20,6	
						F 026 002 134	→ 20,6	
	1.2 i	09.91-10.97	40		BSY	F 026 002 133	← 20,6	
						F 026 002 134	→ 20,6	
		10.96-10.97	40		ERH	LUC	0986 475 677	↔ 22,19
	1.4	03.86-08.91	43		BSY	F 026 002 139	← 22	
						F 026 002 140	→ 22	
		03.86-09.96	43		BSY	F 026 002 133	← 20,6	
						F 026 002 134	→ 20,6	
		06.87-09.97	44		BSY	F 026 002 133	← 20,6	
						F 026 002 134	→ 20,6	
					F 026 002 139	← 22		
					F 026 002 140	→ 22		
	09.91-09.96	43		ERH	LUC	0986 475 677	↔ 22,19	
	09.91-09.97	43		ERH	LUC	0986 475 677	↔ 22,19	
	09.91-09.97	43		LUC	0986 475 677	↔ 22,19		
1.4 i	03.86-03.97	44		BSY	F 026 002 133	← 20,6		
					F 026 002 134	→ 20,6		
					F 026 002 139	← 22		
					F 026 002 140	→ 22		
	09.91-10.97	55-59		BSY	F 026 002 133	← 20,6		
					F 026 002 134	→ 20,6		
				ERH	LUC	0986 475 677	↔ 22,19	

		S														
1.6D	03.86-06.86	40					BSY	F 026 002 139	← 22							
								F 026 002 140	→ 22							
								F 026 002 176	← 22,19							
								F 026 002 177	→ 22,19							
								LUC	0 986 475 233	← 22,19						
									0 986 475 234	→ 22,19						
								03.86-03.97	40					BSY	F 026 002 133	← 20,6
															F 026 002 134	→ 20,6
								07.86-03.97	40					BSY	F 026 002 139	← 22
															F 026 002 140	→ 22
						ERH	LUC	0 986 475 677	↔ 22,19							
							BSY	F 026 002 140	→ 22							
1.9D	09.91-10.97	47-48					BSY	F 026 002 133	← 20,6							
								F 026 002 134	→ 20,6							
								ERH	LUC	0 986 475 677	↔ 22,19					
									BSY	F 026 002 133	← 20,6					
								09.94-09.97	40					BSY	F 026 002 133	← 20,6
															F 026 002 134	→ 20,6
						ERH	LUC	0 986 475 677	↔ 22,19							
<hr/>																
																
	Electrique	09.94-10.97	21					F 026 003 180	20,6							
	1.0	03.86-08.91	27-30				LLE	F 026 003 078	17,5							
							RLE	F 026 003 103	19							
	1.1	03.86-08.91	33/34				BSY	F 026 003 103	19							
								09.91-09.96	36	BSY	F 026 003 103	19				
								09.91-10.97	36	BSY	F 026 003 180	20,6				
	1.2	09.91-09.96	40					F 026 003 180	20,6							
	1.2i	09.91-10.97	40					LLE	F 026 003 180	20,6						
								10.96-10.97	40		F 026 003 180	20,6				
	1.4	03.86-08.91	43				BSY	F 026 003 103	19							
06.87-09.97								44	BSY	F 026 003 103	19					
09.91-09.96								43	LLE	ATE	F 026 003 180	20,6				
09.91-09.97								43		F 026 003 180	20,6					
1.4i	03.86-08.91	44					F 026 003 103	19								
							09.91-03.97	44		F 026 003 180	20,6					
							09.91-10.97	55-59		F 026 003 180	20,6					
						LLE	ATE	F 026 003 180	20,6							
	03.96-09.97	55-59				LLE	F 026 003 180	20,6								
1.6D	03.86-03.97	40				BSY	F 026 003 103	19								
							F 026 003 180	20,6								
							10.87-08.91	40		F 026 003 103	19					
							09.91-03.97	40		F 026 003 180	20,6					
1.9D	09.91-09.97	47-48				BSY	F 026 003 103	19								
							F 026 003 180	20,6								
							09.91-10.97	47-48		F 026 003 180	20,6					
							09.94-09.97	40	LLE	F 026 003 180	20,6					
<hr/>																
	Electrique	09.94-10.97	21					0 204 125 092								
	1.0	03.86-08.91	27-30				LLE	0 204 125 047								
							RLE	0 204 125 049								
	1.1	03.86-08.91	34					LLE	0 204 125 047							
								RLE	0 204 125 049							
								06.87-08.91	33		0 204 125 047					
								09.91-09.96	36		0 204 125 047					
											LLE	0 204 125 047				
						RLE	0 204 125 049									
		10.96-10.97	36					0 204 125 092								
1.2	09.91-09.96	40				LLE	0 204 125 092									
1.2i	09.91-10.97	40					LLE	0 204 125 092								
							10.96-10.97	40		0 204 125 092						



		S										
 ◀ RENAULT Express, Extra, Rapid [F40]												
1.4		03.86-08.91	43			LLE	0 204 125 047					
						RLE	0 204 125 049					
1.4		06.87-09.97	44				0 204 125 047					
							0 204 125 092					
						LLE	0 204 125 092					
							0 204 125 092					
1.4 i		03.86-08.91	44			LLE	0 204 125 047					
						RLE	0 204 125 049					
						LLE	0 204 125 092					
							0 204 125 092					
1.6 D		03.86-08.91	40			LLE	0 204 125 047					
						RLE	0 204 125 049					
						LLE	0 204 125 092					
1.9 D		09.91-03.97	40			LLE	0 204 125 092					
							0 204 125 092					
							0 204 125 092					
1.0		03.86-08.91	27-30/33/ 34			ATE	0 204 131 139 ¹⁰					
						1.1	09.91-10.97	36/40		0 204 131 153 ¹⁰		
1.2, i		03.86-08.91	43			ATE	0 204 131 139 ¹⁰					
							0 204 131 139 ¹⁰					
							0 204 131 154 ¹⁰					
							0 204 131 153 ¹⁰					
1.4		06.87-09.97	44			ATE	0 204 131 139 ¹⁰					
							0 204 131 139 ¹⁰					
							0 204 131 154 ¹⁰					
							0 204 131 153 ¹⁰					
1.4 i		09.91-09.96	43			2TO,ERH	0 204 131 154 ¹⁰					
							0 204 131 154 ¹⁰					
							0 204 131 153 ¹⁰					
							0 204 131 153 ¹⁰					
1.4 i		09.91-09.97	43				0 204 131 154 ¹⁰					
							0 204 131 154 ¹⁰					
							0 204 131 153 ¹⁰					
							0 204 131 153 ¹⁰					
1.4 i		03.86-08.91	44			ATE	0 204 131 139 ¹⁰					
							0 204 131 139 ¹⁰					
							0 204 131 153 ¹⁰					
							0 204 131 153 ¹⁰					
1.6 D		09.91-03.97	40			2TO,ERH	0 204 131 154 ¹⁰					
							0 204 131 154 ¹⁰					
							0 204 131 153 ¹⁰					
							0 204 131 153 ¹⁰					
1.9 D		09.91-10.97	47-48			2TO,ERH	0 204 131 154 ¹⁰					
							0 204 131 154 ¹⁰					
							0 204 131 153 ¹⁰					
							0 204 131 153 ¹⁰					
1.9 D		09.94-09.97	40			2TO,ERH	0 204 131 154 ¹⁰					
							0 204 131 154 ¹⁰					
							0 204 131 153 ¹⁰					
							0 204 131 153 ¹⁰					
1.0		03.86-08.91	27-30/33/ 34				1 987 477 156	↔ 1350				
						1.1	09.91-10.97	36/40		1 987 477 461	↔ 1469	
						1.2, i		03.86-08.91	43			
	1 987 477 156	↔ 1350										
	1 987 477 462	↔ 1465										
	1 987 477 461	↔ 1469										
1.4		06.87-09.97	44				1 987 477 156	↔ 1350				
							1 987 477 156	↔ 1350				
							1 987 477 462	↔ 1465				
							1 987 477 461	↔ 1469				
1.4 i		09.91-09.96	43			2TO,CSA,ERH	1 987 477 462	↔ 1465				
							1 987 477 462	↔ 1469				
							1 987 477 461	↔ 1469				
							1 987 477 462	↔ 1465				
1.4 i		09.91-09.97	43			CSA	1 987 477 462	↔ 1465				
							1 987 477 462	↔ 1465				
							1 987 477 156	↔ 1350				
							1 987 477 461	↔ 1469				
1.4 i		03.86-08.91	44				1 987 477 156	↔ 1350				
							1 987 477 156	↔ 1350				
							1 987 477 461	↔ 1469				
							1 987 477 461	↔ 1469				
1.6 D		09.91-03.97	40			2TO,CSA,ERH	1 987 477 462	↔ 1465				
							1 987 477 462	↔ 1465				
							1 987 477 461	↔ 1469				
							1 987 477 461	↔ 1469				
1.6 D		10.87-03.97	40				1 987 477 156	↔ 1350				
							1 987 477 156	↔ 1350				
							1 987 477 156	↔ 1350				
							1 987 477 156	↔ 1350				
1.9 D		09.91-03.97	40			2TO,CSA,ERH	1 987 477 462	↔ 1465				
							1 987 477 462	↔ 1465				
							1 987 477 461	↔ 1469				
							1 987 477 461	↔ 1469				
1.9 D		09.91-09.92	47-48				1 987 477 156	↔ 1350				
							1 987 477 156	↔ 1350				
							1 987 477 462	↔ 1465				
							1 987 477 462	↔ 1465				
1.9 D		09.91-10.97	47-48			2TO,CSA,ERH	1 987 477 462	↔ 1465				
							1 987 477 462	↔ 1465				
							1 987 477 461	↔ 1469				
							1 987 477 461	↔ 1469				
1.9 D		09.94-09.97	40			2TO,CSA,ERH	1 987 477 462	↔ 1465				
							1 987 477 462	↔ 1465				
							1 987 477 461	↔ 1469				
							1 987 477 461	↔ 1469				

		S							
	◀ RENAULT Kangoo I [FC./KC.]								
	1.9 D DCI	05.00-12.07	59				0 204 001 935	← 54	
							0986 473 357		
							0 204 001 936	→ 54	
							0986 474 357		
	1.9 D DCI 4x4	05.00-12.07	59				0 204 102 995	← 54	0 204 104 272 ⁷
									0 204 104 285 ⁸
							0 204 102 996	→ 54	0 204 104 272 ⁷
	1.9 D DTI	09.98-12.07	59				0 204 001 935	← 54	
							0986 473 357		
							0 204 001 936	→ 54	
							0986 474 357		
		02.00-12.07	59				0 204 102 995	← 54	0 204 104 272 ⁷
									0 204 104 285 ⁸
							0 204 102 996	→ 54	0 204 104 272 ⁷
	1.0 i, i 16V	10.97-12.07	43/44/48/				1987 476 955	← 335	
	1.2 GPL, i, i 16V		50/55/60/				1987 476 956	→ 195	
	1.4 i		62/66						
	1.5 DCI								
	1.6 i								
	1.6 i	06.00-12.07	70				1987 476 955	← 335	
							1987 476 956	→ 195	
	1.6 i 4x4	ABO 06.00-12.07	70				1987 476 955	← 335	
							1987 476 956	→ 195	
		ABS 06.00-12.07	70				1987 476 065	← 335	
							1987 476 067	→ 335	
	1.9 D	10.97-12.07	40/47-48				1987 476 955	← 335	
							1987 476 956	→ 195	
	1.9 DCI	09.98-12.07	59				1987 476 955	← 335	
	1.9 DTI						1987 476 956	→ 195	
	1.9 DCI 4x4	ABO 02.00-12.07	59				1987 476 955	← 335	
	1.9 DTI						1987 476 956	→ 195	
	1.9 DTI 4x4	ABS 02.00-12.07	59				1987 476 065	← 335	
							1987 476 067	→ 335	
	1.9 DTI	01.98-12.07	47				1987 476 955	← 335	
							1987 476 956	→ 195	
	1.0 i, i 16V	09.98-12.07	43/50				F 026 002 483	↔ 22,19	
	1.2 GPL, i, i 16V	10.97-12.07	44/48/50/				F 026 002 482	↔ 22	
	1.4 i		55/60/62				F 026 002 483	↔ 22,19	
	1.5 DCI								
	1.6 i	09.99-12.07	66				F 026 002 483	↔ 22,19	
		06.00-12.07	40/47-48/				F 026 002 482	↔ 22	
			59/70				F 026 002 483	↔ 22,19	
	1.9 D, D DCI, D DTI	10.97-12.07	40/47-48/				F 026 002 482	↔ 22	
			59/70				F 026 002 483	↔ 22,19	
	1.6 i 4x4	06.00-12.07	70				0 204 004 175	← 38	0 204 104 285 ⁸
							0 204 004 176	→ 38	0 204 104 284 ⁷
									0 204 104 285 ⁸
		09.01-12.07	70				0 204 004 175	← 38	0 204 104 284 ⁷
	1.9 D DCI 4x4	02.00-12.07	59				0 204 004 175	← 38	0 204 104 285 ⁸
	1.9 D DTI						0 204 004 176	→ 38	0 204 104 284 ⁷
									0 204 104 285 ⁸





	1.0i, i 16V		09.98-12.07	43/50			0 204 123 372	22,19
	1.2 GPL	ABO	10.97-12.07	44/55			0 204 123 372	22,19
	1.2i	ABS	10.97-12.07	44/55	LLE		0 204 123 589	22,19
	1.2i 16V				RLE		0 204 123 371	22,19
	1.4i	ABO	10.97-12.07	44/55			0 204 123 372	22,19
		ABS	10.97-12.07	44/55	LLE		0 204 123 589	22,19
					RLE		0 204 123 371	22,19
	1.5 DCI	ABO	05.00-12.07	48/50/60/62			0 204 123 372	22,19
		ABS	05.00-12.07	48/50/60/62	LLE		0 204 123 589	22,19
					RLE		0 204 123 371	22,19
	1.6i		09.99-12.07	66			0 204 123 372	22,19
			09.01-12.07	70			0 204 123 372	22,19
		ABO	06.00-12.07	70			0 204 123 372	22,19
	1.6i	ABS	06.00-12.07	70	LLE		0 204 123 589	22,19
	1.6i 4x4				RLE		0 204 123 371	22,19
	1.6i 4x4	ABO	06.00-12.07	70			0 204 123 372	22,19
	1.9 D	ABO	10.97-12.07	40/47-48			0 204 123 372	22,19
		ABS	10.97-12.07	40/47-48	LLE		0 204 123 589	22,19
					RLE		0 204 123 371	22,19
	1.9 DCI, DCI 4x4, DTI	ABS	09.98-12.07	59	LLE		0 204 123 589	22,19
	1.9 DTI 4x4				RLE		0 204 123 371	22,19
	1.9 DCI, DCI 4x4, DTI 4x4	ABO	05.00-12.07	59			0 204 123 372	22,19
	1.9 DTI	ABO	01.98-12.07	47/59			0 204 123 372	22,19
		ABS	01.98-12.07	47	LLE		0 204 123 589	22,19
					RLE		0 204 123 371	22,19

	1.0i, i 16V		09.98-12.07	43/50			0 204 125 763	0 204 120 023
	1.2 GPL	ABO	10.97-12.07	44	LLE		0 204 125 763	0 204 120 023
	1.2i				RLE			0 204 120 023
		ABS	10.97-12.07	44	LLE		0 204 125 786	0 204 120 023
					RLE		0 204 125 787	0 204 120 023
	1.2i 16V	ABO	05.00-12.07	55	LLE		0 204 125 763	0 204 120 023
					RLE			0 204 120 023
		ABS	05.00-12.07	55	LLE		0 204 125 786	0 204 120 023
					RLE		0 204 125 787	0 204 120 023
	1.4i	ABO	10.97-12.07	55			0 204 125 763	0 204 120 023
			09.98-12.07	55	LLE		0 204 125 763	0 204 120 023
					RLE			0 204 120 023
		ABS	10.97-12.07	55			0 204 125 786	0 204 120 023
			09.98-12.07	55	LLE		0 204 125 786	0 204 120 023
					RLE		0 204 125 787	0 204 120 023
	1.5 DCI	ABO	05.00-12.07	48/50/60/62	LLE		0 204 125 763	0 204 120 023
					RLE			0 204 120 023
		ABS	05.00-12.07	48/50/60/62	LLE		0 204 125 786	0 204 120 023
					RLE		0 204 125 787	0 204 120 023
	1.6i		09.99-12.07	66			0 204 125 763	0 204 120 023
			09.01-12.07	70			0 204 125 763	0 204 120 023
		ABO	06.00-12.07	70	LLE		0 204 125 763	0 204 120 023
					RLE			0 204 120 023
	1.6i	ABS	06.00-12.07	70	LLE		0 204 125 786	0 204 120 023
	1.6i 4x4				RLE		0 204 125 787	0 204 120 023
	1.6i 4x4	ABO	06.00-12.07	70	LLE		0 204 125 763	0 204 120 023
					RLE			0 204 120 023





Model	Part	Year	Code	Code	Code	Code	Code	Code
◀ RENAULT Kangoo I [FC./KC.]								
1.9 D	ABO	10.97-12.07	40/47-48	LLE	0 204 125 763		0 204 120 023	
				RLE			0 204 120 023	
	ABS	10.97-12.07	40/47-48	LLE	0 204 125 786		0 204 120 023	
				RLE	0 204 125 787		0 204 120 023	
1.9 DCI, DCI 4x4, DTI, DTI 4x4	ABS	09.98-12.07	59	LLE	0 204 125 786		0 204 120 023	
				RLE	0 204 125 787		0 204 120 023	
1.9 DCI, DCI 4x4, DTI 4x4	ABO	05.00-12.07	59	LLE	0 204 125 763		0 204 120 023	
				RLE			0 204 120 023	
1.9 DTI	ABO	01.98-12.07	47/59	LLE	0 204 125 763		0 204 120 023	
				RLE			0 204 120 023	
	ABS	01.98-12.07	47	LLE	0 204 125 786		0 204 120 023	
				RLE	0 204 125 787		0 204 120 023	
1.0 i, i 16V		09.98-12.07	43/50		0 204 031 111 ¹⁰			
					0 204 031 306 ¹⁰			
1.2 GPL		10.97-01.98	44		0 204 031 306 ¹⁰			
					0 204 031 111 ¹⁰			
1.2 i		10.97-01.98	44		0 204 031 306 ¹⁰			
					0 204 031 111 ¹⁰			
		02.98-12.07	44		0 204 031 111 ¹⁰			
					0 204 031 306 ¹⁰			
		09.98-12.07	44	LLE	0 204 031 306 ¹⁰			
				RLE	0 204 031 111 ¹⁰			
		03.02-12.07	44	ERH,LLE	0 204 031 307 ¹⁰			
				ERH,RLE	0 204 131 388 ¹⁰			
				LLE,NON	0 204 031 306 ¹⁰			
				NON,RLE	0 204 031 111 ¹⁰			
1.2 i 16V		05.00-12.07	55	ERH,LLE	0 204 031 307 ¹⁰			
				ERH,RLE	0 204 131 388 ¹⁰			
				LLE,NON	0 204 031 306 ¹⁰			
				NON,RLE	0 204 031 111 ¹⁰			
1.4 i		10.97-12.07	55	ERH	0 204 031 307 ¹⁰			
				NON	0 204 031 306 ¹⁰			
		09.98-12.07	55	ERH,LLE	0 204 031 307 ¹⁰			
				ERH,RLE	0 204 131 388 ¹⁰			
				LLE,NON	0 204 031 306 ¹⁰			
				NON,RLE	0 204 031 111 ¹⁰			
1.5 DCI		05.00-12.07	48/50/60/ 62	ERH,LLE	0 204 031 307 ¹⁰			
				ERH,RLE	0 204 131 388 ¹⁰			
				LLE,NON	0 204 031 306 ¹⁰			
				NON,RLE	0 204 031 111 ¹⁰			
1.6 i		09.99-12.07	66		0 204 031 111 ¹⁰			
					0 204 031 307 ¹⁰			
		06.00-12.07	70	ERH,LLE	0 204 031 307 ¹⁰			
				ERH,RLE	0 204 131 388 ¹⁰			
				LLE,NON	0 204 031 306 ¹⁰			
				NON,RLE	0 204 031 111 ¹⁰			
		09.01-12.07	70		0 204 031 111 ¹⁰			
					0 204 031 307 ¹⁰			
		01.03-12.07	70	ERH	0 204 031 307 ¹⁰			
				NON	0 204 031 306 ¹⁰			
1.6 i 4x4		06.00-12.07	70	ERH,LLE	0 204 031 307 ¹⁰			
				ERH,RLE	0 204 131 388 ¹⁰			
				LLE,NON	0 204 031 306 ¹⁰			
				NON,RLE	0 204 031 111 ¹⁰			
1.9 D		10.97-01.98	40 47-48	ERH	0 204 031 307 ¹⁰			
					0 204 031 307 ¹⁰			
		01.98-12.07	47	ERH,LLE	0 204 031 307 ¹⁰			
				ERH,RLE	0 204 131 388 ¹⁰			
				LLE,NON	0 204 031 306 ¹⁰			
				NON,RLE	0 204 031 111 ¹⁰			
			47-48	ERH,LLE	0 204 031 307 ¹⁰			
				ERH,RLE	0 204 131 388 ¹⁰			
				LLE,NON	0 204 031 306 ¹⁰			
				NON,RLE	0 204 031 111 ¹⁰			
		02.98-12.07	40 47-48		0 204 031 111 ¹⁰			
					0 204 031 307 ¹⁰			
				ERH	0 204 131 388 ¹⁰			
				NON	0 204 031 111 ¹⁰			









		S								
1.9 D DCI		09.98-12.07	59				ERH,LLE	0 204 031 307 ¹⁰		
1.9 D DCI 4x4							ERH,RLE	0 204 131 388 ¹⁰		
1.9 D DTI							LLE,NON	0 204 031 306 ¹⁰		
							NON,RLE	0 204 031 111 ¹⁰		
1.0 i, i 16V		10.97-12.07	43/44/48/				ERH	1 987 477 634	← 1432	
1.2 GPL, i, i 16V			50/55/60/					1 987 477 635	→ 1442	
1.4 i			62/66				NON	1 987 477 632	← 1413	
1.5 DCI								1 987 477 633	→ 1421	
1.6 i		06.00-12.07	70				ERH	1 987 477 634	← 1432	
								1 987 477 635	→ 1442	
							NON	1 987 477 632	← 1413	
								1 987 477 633	→ 1421	
1.6 i 4x4		06.00-12.07	70				TW	1 987 477 634	← 1432	
								1 987 477 635	→ 1442	
								1 987 482 142	↔ 1450	
1.9 D		10.97-12.07	40/47-48				ERH	1 987 477 634	← 1432	
								1 987 477 635	→ 1442	
							NON	1 987 477 632	← 1413	
								1 987 477 633	→ 1421	
1.9 DCI		05.00-12.07	59				ERH	1 987 477 634	← 1432	
								1 987 477 635	→ 1442	
							NON	1 987 477 632	← 1413	
								1 987 477 633	→ 1421	
1.9 DCI 4x4		05.00-12.07	59				TW	1 987 477 634	← 1432	
								1 987 477 635	→ 1442	
								1 987 482 142	↔ 1450	
1.9 DTI		01.98-12.07	47				ERH	1 987 477 634	← 1432	
								1 987 477 635	→ 1442	
							NON	1 987 477 632	← 1413	
								1 987 477 633	→ 1421	
		09.98-12.07	59				ERH	1 987 477 634	← 1432	
								1 987 477 635	→ 1442	
							NON	1 987 477 632	← 1413	
								1 987 477 633	→ 1421	
		02.00-12.07	59					1 987 482 142	↔ 1450	
1.9 DTI 4x4		05.00-12.07	59				TW	1 987 477 634	← 1432	
								1 987 477 635	→ 1442	
								1 987 482 142	↔ 1450	
1.0 i, i 16V		09.98-12.07	43/50					0 265 231 334 ¹⁶		
1.2 GPL		06.99-06.00	44					0 265 216 741 ¹¹		
		07.00-03.03	44					0 265 216 881 ¹¹		
		04.03-12.07	44					0 265 231 334 ¹⁶		
1.2 i		06.99-06.00	44					0 265 216 741 ¹¹		
		07.00-03.03	44					0 265 216 881 ¹¹		
		03.02-03.03	44				LLE	0 265 216 881 ¹¹		
							RLE	0 265 216 741 ¹¹		
		04.03-12.07	44					0 265 231 334 ¹⁶		
1.2 i 16V		05.00-03.03	55				RLE	0 265 216 741 ¹¹		
		07.00-03.03	55				LLE	0 265 216 881 ¹¹		
		09.01-03.03	55					0 265 216 881 ¹¹		
		04.03-12.07	55					0 265 231 334 ¹⁶		
1.4 i		06.99-06.00	55					0 265 216 741 ¹¹		
		06.00-03.03	55				RLE	0 265 216 741 ¹¹		
		07.00-03.03	55					0 265 216 881 ¹¹		
							LLE	0 265 216 881 ¹¹		
		04.03-12.07	55					0 265 231 334 ¹⁶		





RENAULT Kangoo I [FC./KC.]

1.5 DCI	05.00-03.03	48	LLE	0 265 216 881 ¹¹	
			RLE	0 265 216 741 ¹¹	
	02.01-03.03	60	LLE	0 265 216 881 ¹¹	
			RLE	0 265 216 741 ¹¹	
	04.03-12.07	48		0 265 231 334 ¹⁶	
		60		0 265 231 334 ¹⁶	
	04.05-12.07	50		0 265 231 334 ¹⁶	
				0 265 231 334 ¹⁶	
1.5 DCI	09.99-12.07	62/66		0 265 231 334 ¹⁶	
1.6 i					
1.6 i	06.00-03.03	70	RLE	0 265 216 741 ¹¹	
			LLE	0 265 216 881 ¹¹	
				0 265 231 334 ¹⁶	
				0 265 231 334 ¹⁶	
				0 265 231 334 ¹⁶	
1.6 i 4x4	06.00-03.02	70		0 265 220 601 ¹¹	
1.9 D	01.98-03.03	47-48	RLE	0 265 216 741 ¹¹	
		40		0 265 216 741 ¹¹	
		06.99-06.00	47-48		0 265 216 741 ¹¹
				LLE	0 265 216 741 ¹¹
		07.00-03.03	40		0 265 216 881 ¹¹
			47-48		0 265 216 881 ¹¹
		04.03-12.07	40		0 265 231 334 ¹⁶
			47-48		0 265 231 334 ¹⁶
1.9 DCI	05.00-03.03	59	RLE	0 265 216 741 ¹¹	
			LLE	0 265 216 881 ¹¹	
				0 265 231 334 ¹⁶	
1.9 DCI 4x4	05.00-03.02	59		0 265 220 601 ¹¹	
1.9 DTI	01.98-03.03	47	RLE	0 265 216 741 ¹¹	
				0 265 216 741 ¹¹	
	06.99-06.00	59		0 265 216 741 ¹¹	
				0 265 220 601 ¹¹	
	07.00-03.03	47	LLE	0 265 216 881 ¹¹	
				0 265 216 881 ¹¹	
	04.03-12.07	47		0 265 231 334 ¹⁶	
		59		0 265 231 334 ¹⁶	
1.9 DTI 4x4	05.00-03.02	59		0 265 220 601 ¹¹	
1.0 i	10.97-03.03	43/44/50/55		0 265 006 528 ³	
			ERH,LAB	0 265 006 400 ⁴	
			ERH,RAB	0 265 006 401 ⁴	
			LAB,NON	0 265 006 386 ⁴	
			NON,RAB	0 265 006 387 ⁴	
				0 265 007 527 ³	
			ERH,LAB	0 265 007 532 ⁴	
			ERH,RAB	0 265 007 531 ⁴	
			LAB,NON	0 265 007 534 ⁴	
			NON,RAB	0 265 007 533 ⁴	
1.5 DCI	05.00-03.03	48		0 265 006 528 ³	
			ERH,LAB	0 265 006 400 ⁴	
			ERH,RAB	0 265 006 401 ⁴	
			LAB,NON	0 265 006 386 ⁴	
			NON,RAB	0 265 006 387 ⁴	
	02.01-03.03	60		0 265 006 528 ³	
			ERH,LAB	0 265 006 400 ⁴	
			ERH,RAB	0 265 006 401 ⁴	
			LAB,NON	0 265 006 386 ⁴	
			NON,RAB	0 265 006 387 ⁴	

		S								
1.5 DCI	04.03-12.07	48				0 265 007 527 ³				
			ERH,LAB	0 265 007 532 ⁴						
			ERH,RAB	0 265 007 531 ⁴						
			LAB,NON	0 265 007 534 ⁴						
	60				0 265 007 527 ³					
		ERH,LAB	0 265 007 532 ⁴							
		ERH,RAB	0 265 007 531 ⁴							
		LAB,NON	0 265 007 534 ⁴							
	1.6 i	04.05-12.07	50				0 265 007 527 ³			
				ERH,LAB	0 265 007 532 ⁴					
				ERH,RAB	0 265 007 531 ⁴					
				LAB,NON	0 265 007 534 ⁴					
62					0 265 007 527 ³					
		ERH,LAB	0 265 007 532 ⁴							
		ERH,RAB	0 265 007 531 ⁴							
		LAB,NON	0 265 007 534 ⁴							
1.6 i		09.99-03.03	66				0 265 006 528 ³			
				ERH,LAB	0 265 006 400 ⁴					
				ERH,RAB	0 265 006 401 ⁴					
				LAB,NON	0 265 006 386 ⁴					
	06.00-03.03	70				0 265 006 528 ³				
			ERH,LAB	0 265 006 400 ⁴						
			ERH,RAB	0 265 006 401 ⁴						
			LAB,NON	0 265 006 386 ⁴						
	1.6 i 4x4	04.03-12.07	66				0 265 007 527 ³			
				ERH,LAB	0 265 007 532 ⁴					
				ERH,RAB	0 265 007 531 ⁴					
				LAB,NON	0 265 007 534 ⁴					
70					0 265 007 527 ³					
		ERH,LAB	0 265 007 532 ⁴							
		ERH,RAB	0 265 007 531 ⁴							
		LAB,NON	0 265 007 534 ⁴							
1.9 D		10.97-03.03	40/47-48				0 265 006 528 ³			
				ERH,LAB	0 265 006 400 ⁴					
1.9 D		04.03-12.07	40/47-48				0 265 006 528 ³			
				ERH,LAB	0 265 006 400 ⁴					
	ERH,RAB			0 265 006 401 ⁴						
	LAB,NON			0 265 006 386 ⁴						
	40/47-48				0 265 007 527 ³					
		ERH,LAB	0 265 007 532 ⁴							
		ERH,RAB	0 265 007 531 ⁴							
		LAB,NON	0 265 007 534 ⁴							





◀ RENAULT Kangoo I [FC./KC.]						
	1.9 DCI	05.00-03.03	59		0 265 006 528 ³	
				ERH,LAB	0 265 006 400 ⁴	
				ERH,RAB	0 265 006 401 ⁴	
				LAB,NON	0 265 006 386 ⁴	
				NON,RAB	0 265 006 387 ⁴	
		04.03-12.07	59		0 265 007 527 ³	
				ERH,LAB	0 265 007 532 ⁴	
				ERH,RAB	0 265 007 531 ⁴	
				LAB,NON	0 265 007 534 ⁴	
				NON,RAB	0 265 007 533 ⁴	
	1.9 DCI 4x4	05.00-12.07	59		0 265 006 710 ³	
					0 265 006 711 ⁴	
	1.9 DTI	01.98-03.03	47		0 265 006 528 ³	
				ERH,LAB	0 265 006 400 ⁴	
				ERH,RAB	0 265 006 401 ⁴	
				LAB,NON	0 265 006 386 ⁴	
				NON,RAB	0 265 006 387 ⁴	
		09.98-03.03	59		0 265 006 528 ³	
				ERH,LAB	0 265 006 400 ⁴	
				ERH,RAB	0 265 006 401 ⁴	
				LAB,NON	0 265 006 386 ⁴	
				NON,RAB	0 265 006 387 ⁴	
		02.00-12.07	59		0 265 006 710 ³	
					0 265 006 711 ⁴	
		04.03-12.07	47		0 265 007 527 ³	
				ERH,LAB	0 265 007 532 ⁴	
				ERH,RAB	0 265 007 531 ⁴	
				LAB,NON	0 265 007 534 ⁴	
				NON,RAB	0 265 007 533 ⁴	
			59		0 265 007 527 ³	
				ERH,LAB	0 265 007 532 ⁴	
				ERH,RAB	0 265 007 531 ⁴	
				LAB,NON	0 265 007 534 ⁴	
				NON,RAB	0 265 007 533 ⁴	
	1.9 DTI 4x4	05.00-12.07	59		0 265 006 710 ³	
					0 265 006 711 ⁴	



Kangoo II [FW./KW.]

	1.5 DCI	A BO	01.08→	50/63/76/78	0 204 123 760	22,19	
		ABS	01.08→	50/63/76/78	0 204 123 759	22,19	
	1.6 i	A BO	01.08→	64/78	0 204 123 760	22,19	
		ABS	01.08→	64/78	0 204 123 759	22,19	
	1.5 DCI		01.08→	50/63/64/	0 265 007 936 ³		
				76/78	FKR,LAB	0 265 007 939 ⁴	
	1.6 i				FKR,RAB	0 265 007 940 ⁴	
					LAB,NOR	0 265 007 937 ⁴	
					NOR,RAB	0 265 007 938 ⁴	
	1.5 DCI		01.08→	50/63/64/	0 265 005 701		
	1.6 i			76/78			



Kerax



	260	05.99-12.03	188/219/		0 486 104 102 ¹⁶	
	300		249/250/			
	340		280/288			
	350					
	385					
	400					

Mascott



	90	01.99→	63/78/85/	35T	F 026 003 140	25,4
	110, .60		92/95/103/			
	120		107/110/			
	130		115			
	140					
	150					
	160					

	90	01.99-06.04	63/78	35T	0 204 021 576	
	110, .60					
	120	05.04-05.07	85	35T	0 204 021 576	
				56T	0 204 051 183 ²⁵	
	130	01.99-06.04	92	35T	0 204 021 576	
		06.07→	95	TW	0 204 051 074 ²⁵	
	140	01.01-06.04	103/107	35T	0 204 021 576	
	150					
	150	06.07→	110	TW	0 204 051 074 ²⁵	
	160	05.04-05.07	115	35T	0 204 021 576	
				56T	0 204 051 183 ²⁵	

	130	06.07→	95/110		0 265 233 030 ¹¹	
	150					

Master



	P28 -35	10.86-09.97	55/57-59/		1 987 481 034	504
	T28 -35, -35D		67/69			
	2.5 dCi 100, dCi 120	ABO 11.06→	74/88/107	OE	1 987 481 151	538
	2.5 dCi 120 FAP			UE	1 987 481 150	507
	2.5 dCi 150 FAP	ABS 11.06→	74/88/107		1 987 481 186	545































	2.5 dCi 100	ABO 11.06→	74/88/107		0 204 102 969	← 45
	2.5 dCi 120				0 204 103 969	↻
	2.5 dCi 120 FAP				0 204 102 970	→ 45
	2.5 dCi 150 FAP				0 204 103 970	↻
		ABS 11.06→	74/88/107		0 204 004 237	→ 45
					0 204 004 238	← 45



	P28 -35	10.86-09.97	58		1 987 481 034	504
	2.5 dCi 100, dCi 120	ABO 11.06→	74/88/107		1 987 476 905 ¹	435
	2.5 dCi 120 FAP, dCi 150 FAP				1 987 481 152 ²	358



◀ RENAULT Master									
	P28 -35		10.86-09.97	57-59			0 986 475 420	↔ 25,4	
	T28 -35								
	2.8D		01.02-09.04	63/84			F 026 002 532	← 23,8	
	2.8DTI						F 026 002 533	→ 23,8	
	2.5 dCi 100		11.06→	74/88/107			0 204 004 320	← 42	0 204 104 261 ⁸
	2.5 dCi 120						0 986 473 260		
	2.5 dCi 120 FAP						0 204 004 321	→ 42	0 204 104 261 ⁸
	2.5 dCi 150 FAP						0 986 474 260		
	P28 -35		10.86-09.97	55/57-59/			0 986 480 636	22,19	
	T28 -35, -35D			67/69					
	2.5 dCi 100, dCi 120	ABO	11.06→	74/88/107			0 204 123 651	23,8	
	2.5 dCi 120 FAP, dCi 150 FAP	ABS	11.06→	74/88/107			0 204 123 763	23,8	
	P28 -35	ABS	10.86-09.97	55/57-59/			0 204 125 811		
	T28 -35, -35D			67/69					
	2.5 dCi 100, dCi 120	ABO	11.06→	74/88/107			0 204 125 819		0 204 120 023
	2.5 dCi 120 FAP, dCi 150 FAP	ABS	11.06→	74/88/107			0 204 125 811		
	2.5 dCi 100, dCi 120		11.06→	74/88/107		R34,X38	0 204 031 309 ¹⁰		
	2.5 dCi 120 FAP					3TN,R38	0 204 031 310 ¹⁰		
	2.5 dCi 150 FAP								
	P28 -35		10.86-09.97	58			1 987 482 045	1780	
	T28 -35, -35D		10.86-09.97	55/57-59/67/69			1 987 482 044	1752	
	2.5 dCi 100, dCi 120		11.06→	74/88/107		ABM	1 987 477 261	1737	
	2.5 dCi 120 FAP, dCi 150 FAP						1 987 482 013	1420	
Master [X70]									
	1.9 dCi 80		05.00-09.03	60		OE	1 987 481 151	538	
						UE	1 987 481 150	507	
		ABO	10.03-10.06	60		OE	1 987 481 151	538	
						UE	1 987 481 150	507	
		ABS	10.03-10.06	60			1 987 481 186	545	
	1.9 dTi 80		01.00-07.00	58		OE	1 987 476 906	565	
			08.00-09.03	58		OE	1 987 481 151	538	
						UE	1 987 481 150	507	
	2.2 dCi 90		01.00-09.03	66		OE	1 987 481 151	538	
						UE	1 987 481 150	507	
		ABO	10.03-10.06	66		OE	1 987 481 151	538	
						UE	1 987 481 150	507	
		ABS	10.03-10.06	66			1 987 481 186	545	
	2.5 D		10.97-07.00	60		OE	1 987 476 906	565	
			10.97-09.03	60		OE	1 987 476 906	565	
			08.00-09.03	60		OE	1 987 481 151	538	
					UE	1 987 481 150	507		
2.5 dCi 90		05.00-09.03	84		OE	1 987 481 151	538		
2.5 dCi 120					UE	1 987 481 150	507		
2.5 dCi 100	ABO	10.03-10.06	73		OE	1 987 481 151	538		
2.5 dCi 110					UE	1 987 481 150	507		
	ABS	10.03-10.06	73			1 987 481 186	545		
2.5 dCi 120	ABO	10.03-10.06	84		OE	1 987 481 151	538		
					UE	1 987 481 150	507		
	ABS	10.03-10.06	84			1 987 481 186	545		
2.8 D		05.01-10.04	86		OE	1 987 481 151	538		
					UE	1 987 481 150	507		

		S							
2.8 dTi 110			10.97-07.00	84		OE	1 987 476 906	565	
2.8 dTi 120			08.00-09.03	84		OE	1 987 481 151	538	
						UE	1 987 481 150	507	
3.0 dCi 140		ABO	10.03-10.06	100		OE	1 987 481 151	538	
						UE	1 987 481 150	507	
		ABS	10.03-10.06	100			1 987 481 186	545	
 1.9 dCi 80			05.00-07.00	60			0 204 102 730	← 45	
							0 204 103 730		
							0 204 102 731	→ 45	
							0 204 103 731		
			08.00-09.03	60			0 204 102 969	← 45	
							0 204 103 969		
							0 204 102 970	→ 45	
							0 204 103 970		
		ABO	10.03-10.06	60			0 204 102 969	← 45	
							0 204 103 969		
							0 204 102 970	→ 45	
							0 204 103 970		
		ABS	10.03-10.06	60			0 204 004 237	→ 45	
							0 204 004 238	← 45	
1.9 dTi 80			01.00-07.00	58			0 204 102 730	← 45	
							0 204 103 730		
							0 204 102 731	→ 45	
							0 204 103 731		
			08.00-09.03	58			0 204 102 969	← 45	
							0 204 103 969		
							0 204 102 970	→ 45	
							0 204 103 970		
2.2 dCi 90			01.00-07.00	66			0 204 102 730	← 45	
							0 204 103 730		
							0 204 102 731	→ 45	
							0 204 103 731		
			08.00-09.03	66			0 204 102 969	← 45	
							0 204 103 969		
							0 204 102 970	→ 45	
							0 204 103 970		
		ABO	10.03-10.06	66			0 204 102 969	← 45	
							0 204 103 969		
							0 204 102 970	→ 45	
							0 204 103 970		
		ABS	10.03-10.06	66			0 204 004 237	→ 45	
							0 204 004 238	← 45	
2.5 D			10.97-07.00	60/84			0 204 102 730	← 45	
2.5 dCi 90							0 204 103 730		
							0 204 102 731	→ 45	
							0 204 103 731		
			08.00-09.03	60/84			0 204 102 969	← 45	
							0 204 103 969		
							0 204 102 970	→ 45	
							0 204 103 970		
2.5 dCi 100		ABO	10.03-10.06	73			0 204 102 969	← 45	
2.5 dCi 110							0 204 103 969		
							0 204 102 970	→ 45	
							0 204 103 970		
		ABS	10.03-10.06	73			0 204 004 237	→ 45	
							0 204 004 238	← 45	



		S								
RENAULT Master [X70]										
2.5 dCi 120		07.02-09.03	84			0 204 102 969	←	45		
				0 204 103 969						
				0 204 102 970	→	45				
				0 204 103 970						
	ABO	10.03-10.06	84			0 204 102 969	←	45		
				0 204 103 969						
				0 204 102 970	→	45				
				0 204 103 970						
	ABS	10.03-10.06	84			0 204 004 237	→	45		
				0 204 004 238	←	45				
						0 204 102 969	←	45		
						0 204 103 969				
2.8 D	05.01-10.04	86			0 204 102 969	←	45			
					0 204 103 969					
					0 204 102 970	→	45			
2.8 dTi 110	10.97-07.00	84			0 204 102 730	←	45			
					0 204 103 730					
					0 204 102 731	→	45			
2.8 dTi 120	08.00-09.03	84			0 204 102 969	←	45			
					0 204 103 969					
					0 204 102 970	→	45			
3.0 dCi 140	ABO	10.03-10.06	100			0 204 102 969	←	45		
						0 204 103 969				
						0 204 102 970	→	45		
ABS	10.03-10.06	100			0 204 004 237	→	45			
					0 204 004 238	←	45			
					0 204 103 970					
RENAULT Master [X70]										
1.9 dCi 80		05.00-09.03	60			1 987 476 905 ¹		435		
						1 987 481 152 ²		358		
						1 987 476 905 ¹		435		
	ABO	10.03-10.06	60			1 987 481 152 ²		358		
						1 987 476 905 ¹		435		
						1 987 481 152 ²		358		
	1.9 dTi 80	01.00-09.03	58			1 987 476 905 ¹		435		
						1 987 481 152 ²		358		
	2.2 dCi 90	01.00-09.03	66			1 987 476 905 ¹		435		
						1 987 481 152 ²		358		
						1 987 476 905 ¹		435		
						1 987 481 152 ²		358		
				1 987 481 152 ²		358				
ABO	10.03-10.06	66			1 987 476 905 ¹		435			
					1 987 481 152 ²		358			
					1 987 476 905 ¹		435			
2.5 D	10.97-09.03	60			1 987 476 905 ¹		435			
					1 987 481 152 ²		358			
		08.00-09.03	60			1 987 481 152 ²		358		
2.5 dCi 90			05.00-09.03	84			1 987 476 905 ¹		435	
2.5 dCi 120							1 987 481 152 ²		358	
2.5 dCi 100	ABO	10.03-10.06	73			1 987 476 905 ¹		435		
2.5 dCi 110						1 987 481 152 ²		358		
2.5 dCi 120	ABO	10.03-10.06	84			1 987 476 905 ¹		435		
						1 987 481 152 ²		358		
2.8 dTi 110		10.97-09.03	84			1 987 476 905 ¹		435		
						1 987 481 152 ²		358		
2.8 dTi 120		08.00-09.03	84			1 987 481 152 ²		358		
						1 987 476 905 ¹		435		
2.8 dTi 120		10.97-09.03	84			1 987 476 905 ¹		435		
						1 987 481 152 ²		358		
						1 987 481 152 ²		358		
		08.00-09.03	84			1 987 481 152 ²		358		
3.0 dCi 140	ABO	10.03-10.06	100			1 987 476 905 ¹		435		
						1 987 481 152 ²		358		



	1.9 dCi 80, dTi 80	10.97-07.00	58/60/66/	F 026 002 532	← 23,8	
	2.2 dCi 90		84	F 026 002 533	→ 23,8	
	2.5 D, dCi 90					
	2.8 dTi 110, dTi 120					
	1.9 dCi 80	08.00-09.03	60	0 204 004 320	← 42	
				0 986 473 260		
				0 204 004 321	→ 42	
				0 986 474 260		
		07.01-09.03	60			0 204 104 261^B
		10.03-10.06	60	0 204 004 320	← 42	0 204 104 261^B
				0 986 473 260		
				0 204 004 321	→ 42	0 204 104 261^B
				0 986 474 260		
	1.9 dTi 80	08.00-09.03	58	0 204 004 320	← 42	
				0 986 473 260		
				0 204 004 321	→ 42	
				0 986 474 260		
		07.01-09.03	58			0 204 104 261^B
	2.2 dCi 90	05.00-09.03	66	0 204 004 320	← 42	
				0 986 473 260		
				0 204 004 321	→ 42	
				0 986 474 260		
		08.00-09.03	66	0 204 004 320	← 42	
				0 986 473 260		
				0 204 004 321	→ 42	
				0 986 474 260		
		07.01-09.03	66			0 204 104 261^B
		10.03-10.06	66	0 204 004 320	← 42	0 204 104 261^B
				0 986 473 260		
				0 204 004 321	→ 42	0 204 104 261^B
				0 986 474 260		
	2.5 D	08.00-09.03	60	0 204 004 320	← 42	
				0 986 473 260		
				0 204 004 321	→ 42	
				0 986 474 260		
	2.5 dCi 90	08.00-09.03	84	0 204 004 320	← 42	
				0 986 473 260		
				0 204 004 321	→ 42	
				0 986 474 260		
		07.01-09.03	84			0 204 104 261^B
	2.5 dCi 100	10.03-10.06	73	0 204 004 320	← 42	0 204 104 261^B
	2.5 dCi 110			0 986 473 260		
				0 204 004 321	→ 42	0 204 104 261^B
				0 986 474 260		
	2.5 dCi 120	07.02-09.03	84	0 204 004 320	← 42	
				0 986 473 260		
				0 204 004 321	→ 42	
				0 986 474 260		
						0 204 104 261^B
		10.03-10.06	84	0 204 004 320	← 42	0 204 104 261^B
				0 986 473 260		
				0 204 004 321	→ 42	0 204 104 261^B
				0 986 474 260		
	2.8 D	05.01-10.04	86	0 204 004 320	← 42	
				0 986 473 260		
				0 204 004 321	→ 42	
				0 986 474 260		



		S								
◀ RENAULT Master [X70]										
2.8 dTi 110		08.00-09.03	84				0 204 004 320	← 42		
				0986 473 260						
		07.01-09.03	84				0 204 004 321	→ 42		
				0986 474 260						0 204 104 261 ⁸
2.8 dTi 120		08.00-09.03	84				0 204 004 320	← 42		
				0986 473 260						
				0 204 004 321	→ 42					
						0986 474 260				
3.0 dCi 140		10.03-10.06	100				0 204 004 320	← 42	0 204 104 261 ⁸	
				0986 473 260						
							0 204 004 321	→ 42	0 204 104 261 ⁸	
							0986 474 260			
	1.9 dCi 80	05.00-09.03	60				0 204 123 651	23,8		
				ABO 10.03-10.06	60		0 204 123 651	23,8		
				ABS 10.03-10.06	60		0 204 123 634	23,8		
	1.9 dTi 80	01.00-09.03	58				0 204 123 651	23,8		
2.2 dCi 90		01.00-09.03	66				0 204 123 651	23,8		
				ABO 10.03-10.06	66		0 204 123 651	23,8		
				ABS 10.03-10.06	66		0 204 123 634	23,8		
2.5 D, dCi 90		10.97-09.03	60/84				0 204 123 651	23,8		
2.5 dCi 100	ABO	10.03-10.06	73				0 204 123 651	23,8		
2.5 dCi 110	ABS	10.03-10.06	73				0 204 123 634	23,8		
2.5 dCi 120		07.02-09.03	84				0 204 123 651	23,8		
				ABO 10.03-10.06	84		0 204 123 651	23,8		
				ABS 10.03-10.06	84		0 204 123 634	23,8		
2.8 D		05.01-10.04	86				0 204 123 651	23,8		
				ABS 05.01-10.04	86		0 204 123 634	23,8		
2.8 dTi 110, dTi 120		10.97-09.03	84				0 204 123 651	23,8		
3.0 dCi 140		10.03-10.06	100				0 204 123 651	23,8		
				ABS 10.03-10.06	100		0 204 123 634	23,8		
	1.9 dCi 80	05.00-09.03	60				0 204 125 819		0 204 120 023	
				ABO 10.03-10.06	60		0 204 125 819		0 204 120 023	
				ABS 10.03-10.06	60		0 204 125 811		0 204 120 023	
	1.9 dTi 80	01.00-09.03	58				0 204 125 819		0 204 120 023	
2.2 dCi 90		01.00-09.03	66				0 204 125 819		0 204 120 023	
				ABO 10.03-10.06	66		0 204 125 819		0 204 120 023	
				ABS 10.03-10.06	66		0 204 125 811		0 204 120 023	
2.5 D, dCi 90		10.97-09.03	60/84				0 204 125 819		0 204 120 023	
2.5 dCi 100	ABO	10.03-10.06	73				0 204 125 819		0 204 120 023	
2.5 dCi 110	ABS	10.03-10.06	73				0 204 125 811		0 204 120 023	
2.5 dCi 120		07.02-09.03	84				0 204 125 819		0 204 120 023	
				ABO 10.03-10.06	84		0 204 125 819		0 204 120 023	
				ABS 10.03-10.06	84		0 204 125 811		0 204 120 023	
2.8 D		05.01-10.04	86				0 204 125 819		0 204 120 023	
				ABS 05.01-10.04	86		0 204 125 811		0 204 120 023	
2.8 dTi 110, dTi 120		10.97-09.03	84				0 204 125 819		0 204 120 023	
3.0 dCi 140		10.03-10.06	100				0 204 125 819		0 204 120 023	
				ABS 10.03-10.06	100		0 204 125 811		0 204 120 023	
	1.9 dCi 80, dTi 80	10.97-10.06	58/60/66/		R34,X38	0 204 031 309 ¹⁰				
	2.2 dCi 90		73/84/86/		3TN,R38	0 204 031 310 ¹⁰				
	2.5 D, dCi 90, dCi 100		100							
	2.5 dCi 110, dCi 120									
	2.8 D, dTi 110, dTi 120									
3.0 dCi 140										



	1.9 dCi 80, dTi 80	10.97-10.06	58/60/66/	ABM	1 987 477 261	1737
	2.2 dCi 90		73/84/86/		1 987 482 013	1420
	2.5 D, dCi 90, dCi 100		100			
	2.5 dCi 110, dCi 120					
	2.8 D, dTi 110, dTi 120					
	3.0 dCi 140					

Midliner



	CE 160	10.86-12.01	117		0 204 162 027	
--	---------------	-------------	-----	--	----------------------	--

Premium



	210 Distribution	04.96-09.01	154/184/		0 486 104 102 ¹⁶	
	250 Distribution		188			
	260 Distribution					
	260 SP	05.99-12.01	188		0 486 104 102 ¹⁶	
	300 Distribution, Route	02.96-09.01	219/249/		0 486 104 102 ¹⁶	
	340 Distribution, Route		280/288/			
	385 Distribution, Route		303			
	400 Distribution, Route					
	420 Route					

R



	340	03.86-01.90	247-259		0 204 162 027	
	357	01.86-06.86	259-264		0 204 162 027	
	390	07.85-06.86	286-296	Get.Nr. Fuller	0 204 162 027	

	385	03.95-10.96	283/305		0 265 150 328 ¹⁶	
	420					

Tracer



		04.96→	185/186-191	RAB	0 265 050 141	
--	--	--------	-------------	-----	----------------------	--















Traffic



	1.7	03.89-10.97	50	OE	1 987 476 032	315
				UE	1 987 476 432	315
	1.9D	11.97-05.01	47-48	ANO	1 987 476 432	315
				UE	1 987 476 032	315
	2.1D	03.89-10.97	47/69-71/	OE	1 987 476 032	315
	2.2i		74	UE	1 987 476 432	315



		S												
	◀ RENAULT Traffic													
2.5 D		03.89-10.97	55	OE		1987 476 032	315							
						UE	1987 476 432	315						
							11.97-05.01	55	ANO	1987 476 432	315			
									UE	1987 476 032	315			
2.5 D 4x4		11.97-05.01	55	ANO		1987 476 432	315							
				UE		1987 476 032	315							
	1.7	03.89-10.97	50	EIZ		0 204 102 087	← 54	0 204 104 030 ⁷						
						0 204 103 087								
						0 204 102 089	→ 54	0 204 104 030 ⁷						
						0 204 103 089								
					ZWZ		0 204 102 052	← 45	0 204 104 042 ⁷					
							0 204 103 052							
						0 204 102 054	→ 45	0 204 104 042 ⁷						
						0 204 103 054								
				1.9 D		11.97-05.01	47-48			0 204 102 052	← 45	0 204 104 042 ⁷		
										0 204 103 052				
										0 204 102 054	→ 45	0 204 104 042 ⁷		
										0 204 103 054				
2.1 D		03.89-10.97	47/69-71/ 74	EIZ		0 204 102 087	← 54	0 204 104 030 ⁷						
						0 204 103 087								
						0 204 102 089	→ 54	0 204 104 030 ⁷						
						0 204 103 089								
					ZWZ		0 204 102 052	← 45	0 204 104 042 ⁷					
							0 204 103 052							
		0 204 102 054	→ 45	0 204 104 042 ⁷										
		0 204 103 054												
2.5 D		03.89-10.97	55	EIZ		0 204 102 087	← 54	0 204 104 030 ⁷						
						0 204 103 087								
						0 204 102 089	→ 54	0 204 104 030 ⁷						
						0 204 103 089								
					ZWZ		0 204 102 052	← 45	0 204 104 042 ⁷					
							0 204 103 052							
						0 204 102 054	→ 45	0 204 104 042 ⁷						
						0 204 103 054								
						11.97-05.01	55			0 204 102 052	← 45	0 204 104 042 ⁷		
										0 204 103 052				
										0 204 102 054	→ 45	0 204 104 042 ⁷		
										0 204 103 054				
2.5 D 4x4		11.97-05.01	55			0 204 102 052	← 45	0 204 104 042 ⁷						
						0 204 103 052								
						0 204 102 054	→ 45	0 204 104 042 ⁷						
						0 204 103 054								
	1.7	03.89-10.97	50	L38		1987 476 700	380							
						L45	1987 476 701	455						
					1.9 D		11.97-05.01	47-48	L38	1987 476 700	380			
									L45	1987 476 701	455			
					2.1 D		03.89-10.97	47/55/69-71/74	L45	1987 476 701	455			
					2.2 i		03.89-05.01	47/55/69-71/74	L38	1987 476 700	380			
					2.5 D									
					2.5 D 4x4		11.97-05.01	47/55/69-71/74	L38	1987 476 700	380			
						1.7	03.89-10.97	50	BSY		F 026 002 163	↔ 22		
											F 026 002 164	↔ 23,8		
										LUC		0 986 475 051	↔ 25,4	
												F 026 002 164	↔ 23,8	
1.9 D	ABO	11.97-05.01	47-48							0 986 475 051	↔ 25,4			
	ABS	11.97-05.01	47-48							F 026 002 164	↔ 23,8			
2.1 D		03.89-10.97	47/69-71/	BSY					F 026 002 163	↔ 22				
2.2 i			74						F 026 002 164	↔ 23,8				
				LUC					0 986 475 051	↔ 25,4				

		S							
2.5 D		03.89-10.97	55			BSY	F 026 002 163	↔ 22	
							F 026 002 164	↔ 23,8	
						LUC	0 986 475 051	↔ 25,4	
		11.97-05.01	55				0 986 475 051	↔ 25,4	
2.5 D 4x4		11.97-05.01	55				0 986 475 051	↔ 25,4	
									
	1.7	03.89-09.94	50				0 986 480 913	23	
		03.89-10.97	50			KW,LLE	0 986 480 902	20	
						KW,RLE	0 986 480 913	23	
	1.9 D	ABO 11.97-05.01	47-48				F 026 003 410	23,8	
		ABS 11.97-05.01	47-48				0 204 123 409		
	2.1 D	03.89-10.97	43			KW,LLE	0 986 480 902	20	
						KW,RLE	0 986 480 913	23	
		09.94-10.97	47				0 986 480 913	23	
		ABO 09.94-10.97	47				0 986 480 913	23	
	2.2 i	09.94-10.97	74			TW	0 986 480 916	25,4	
	2.5 D	03.89-10.97	55				0 986 480 916	25,4	
						TW	0 986 480 913	23	
							0 986 480 916	25,4	
		ABO 11.97-05.01	55				0 204 123 651	23,8	
	2.5 D, D 4x4	ABS 11.97-05.01	55				0 204 123 409		
	2.5 D 4x4	ABO 11.97-05.01	55				0 204 123 651	23,8	
	1.9 D	11.97-05.01	47-48						0 204 120 023
	2.5 D, D 4x4	11.97-05.01	55				0 204 125 580		0 204 120 023
	2.1 D	03.89-10.97	47/55/				0 204 162 024		
	2.2 i		69-71/74						
	2.5 D								
	1.7	03.89-05.01	47-48/50/				0 986 482 002 ¹⁰		
	1.9 D		55/69-71/						
	2.1 D		74						
	2.2 i								
	2.5 D, D 4x4								
	1.7	03.89-10.97	50				1 987 477 662	747	
							1 987 477 663	← 1330	
							1 987 477 664	← 1295	
							1 987 477 665	→ 1424	
							1 987 477 666	→ 1390	
			58				1 987 477 664	← 1295	
							1 987 477 666	→ 1390	
	1.9 D	11.97-05.01	47-48				1 987 477 662	747	
							1 987 477 663	← 1330	
							1 987 477 665	→ 1424	
	2.0	03.89-10.97	43/59				1 987 477 664	← 1295	
	2.1 D						1 987 477 666	→ 1390	
	2.1 D	09.94-10.97	47				1 987 477 662	747	
							1 987 477 663	← 1330	
							1 987 477 665	→ 1424	
	2.2 i	03.89-10.97	69-71/74	Fg.Nr. T...			1 987 477 662	747	
							1 987 477 663	← 1330	
							1 987 477 665	→ 1424	
				Fg.Nr. V...			1 987 477 664	← 1295	
							1 987 477 666	→ 1390	





◀ RENAULT Traffic											
	2.5 D	03.89-10.97	55	Fg.Nr. T...		1987 477 662	747				
						1987 477 663	← 1330				
						1987 477 665	→ 1424				
						Fg.Nr. V...		1987 477 664	← 1295		
								1987 477 666	→ 1390		
	11.97-05.01		55	1987 477 662	747						
				1987 477 663	← 1330						
				1987 477 664	← 1295						
				1987 477 665	→ 1424						
				1987 477 666	→ 1390						
2.5 D 4x4											
		11.97-05.01	55			1987 477 664	← 1295				
						1987 477 666	→ 1390				

	1.7	03.89-05.01	47-48/50/		0 265 105 038 ¹⁶		
	1.9 D		55/69-71/				
	2.1 D		74				
	2.2 i						
	2.5 D, D 4x4						

	1.7	03.89-05.01	47-48/50/	LAB	0 265 006 154 ⁴		
	1.9 D		55/69-71/		0 265 006 156 ³		
	2.1 D		74	RAB	0 265 006 155 ⁴		
	2.2 i				0 265 006 157 ³		
	2.5 D, D 4x4						

Traffic [EL./FL./JL.]

	1.9 DCI	05.01-10.04	60/74		1987 476 700	380		
			11.04-12.06	60/74	1987 481 165	415		
			2.0 DCI, 16V	01.06→	66/85/86	1987 481 165	415	
			2.0 16V	06.01-10.04	88/98	1987 476 700	380	
			2.5 DCI	11.04-12.06	88/98	1987 481 165	415	
			2.5 DCI	01.06→	107	1987 481 165	415	

	1.9 DCI	05.01→	60/66/74/		1987 476 914 ¹	222	
			2.0 DCI, 16V	85/86/88/			
			2.5 DCI	98/107			

	1.9 DCI	10.03-12.06	60/74		0 986 480 828	25,4	
		ABO 05.01-09.03	60/74		0 986 480 887	20,6	
		ABS 05.01-09.03	60/74		0 986 480 831	25,4	
	2.0 16V	10.03-12.06	88/98		0 986 480 828	25,4	
	2.5 DCI	ABO 06.01-09.03	88/98		0 986 480 887	20,6	
		ABS 06.01-09.03	88/98		0 986 480 831	25,4	

	1.9 DCI	05.01→	60/66/74/		1987 477 116	→ 1603		
			2.0 DCI	85/86/88/	1987 477 137	← 1503		
	2.0 16V			98/107	FKR,MI	1987 482 043	1190	
					FLR,MI	1987 482 145	1923	
					LLE	1987 482 042	508	
					RLE	1987 482 146	2198	
	2.5 DCI		06.01→	60/66/74/	MI	1987 482 145	1923	
				85/86/88/				
				98/107				





SANTANA

2000-Serie

							
	2000 D	01.85-03.88	70			0 204 123 233	28,57

SCANIA

Serie 82 [BUS]

							
	FCL KCL, CR SCL, HR	03.88-11.94				0 265 050 025 ⁴	



Serie 86 [BUS]

							
	B BF, S BR S BS	03.88-11.94	114/155			0 265 050 025 ⁴	

Serie 92 [BUS]



							
	KCL KCR	03.88-11.94				0 265 050 025 ⁴	

Serie 93

							
	GL PL RL T	03.88-08.97	128/155/ 162/167/ 185/207/ 208		TW	0 265 150 201 ¹⁶	

	GL PL RL T	03.88-08.97	128/155/ 162/167/ 185/207/ 208	Fg.Nr. →1174406 SSS, →4307551 SNL Fg.Nr. 1204128 SSS→, 4338839 SNL→, 9003735 SAN→	LF BO	0 265 050 035 ³ 0 265 050 145 ⁴	
--	---------------------	-------------	---	---	-------	--	--

Serie 93 [BUS]

							
	KCLB KCRB	11.87-02.97	185	Fg.Nr. 1824259 SBK→		0 265 050 145 ⁴	





Serie 94



	P,R 220 P,R 260 P,R 310	08.96-08.02	162/191/ 228	FBA,RAB	0 265 050 145 ⁴
--	-------------------------------	-------------	-----------------	---------	-----------------------------------

Serie 94 [BUS]



	K E, IB L IB, UB N UB	03.97-08.02	162/191/ 228	LAB,TBR RAB,TBR	0 486 000 028 ⁴ 0 486 000 029 ⁴
--	-----------------------------	-------------	-----------------	--------------------	--

Serie 111 [BUS]



	BF CKD	01.91-11.94			0 265 050 025 ⁴
--	--------	-------------	--	--	-----------------------------------

Serie 112 [BUS]



	BK CLB BR CR F K CLB, P N CLB S	03.88-11.94	139-151/ 158/184/ 224/232/ 254		0 265 050 025 ⁴
--	---	-------------	---	--	-----------------------------------

Serie 113



	P,R 310, 313, 320, 340, 343, P,R 350, 360 R T 215, 320, 340, 360	05.88-05.00	158/228/230/235/ 236/250/252/258/ 265/267/280	TW	0 265 150 201 ¹⁶
--	---	-------------	---	----	------------------------------------

	P P,R 310, 313, 320, 340, 343, 350 P,R 360, 400 R T, 215, 320, 340, 360	05.88-12.00	158/228/ 229/ 230-232/ 235/236/ 250/252/ 254/258/ 265/267/ 280/295	Fg.Nr. →1174406 SSS, →4307551 SNL Fg.Nr. 1204128 SSS→, 4338839 SNL→, 9003735 SAN→	LF BO	0 265 050 035 ³ 0 265 050 145 ⁴
--	---	-------------	---	---	-------	--

Serie 114



	P,R 320, 340, 360, 380 P 260 T 320, 340, 360, 380	02.96-09.04	191/235/ 250/265/ 280	FBA,RAB	0 265 050 145 ⁴
--	---	-------------	-----------------------------	---------	-----------------------------------





Serie 114 [BUS]



	KEB	08.97→	250/265/	LAB,TBR	0 486 000 028 ⁴
	KIB		280	RAB,TBR	0 486 000 029 ⁴

Serie 124



	P,R 360	09.95-02.02	265/294	FBA,RAB	0 265 050 145 ⁴
	P,R 400				

Serie 124 [BUS]



	KEB	10.97-08.02	265/309	LAB,TBR	0 486 000 028 ⁴
				RAB,TBR	0 486 000 029 ⁴
	KIB	08.97-02.02	265	FLA,LAB	0 486 000 028 ⁴
				FLA,RAB	0 486 000 029 ⁴
			309	FLA,LAB	0 486 000 028 ⁴
				FLA,RAB	0 486 000 029 ⁴
		08.97-08.02	309	LAB,TBR	0 486 000 028 ⁴
		08.97→	294	RAB,TBR	0 486 000 029 ⁴

Serie 143



	R 405, 420, 450	05.88-12.96	297/309/	TW	0 265 150 201 ¹⁶
	T 405, 420, 450		331/333		

	R 405, 420, 450, 470, 500, 530	03.88-12.96	297/309/	Fg.Nr. →1180266 SSS,	TW	0 265 152 001 ²²
	T 405, 420, 450, 470, 500		331/333/	→4312234 SNL		
			346/368/	Fg.Nr. 1180267 SSS→,		0 265 152 004 ²²
			390	4312235 SNL→		

	R 405, 420, 450, 470, 500, 530	03.88-12.96	297/309/	Fg.Nr. →1174406 SSS,	LF	BO	0 265 050 035 ³
	T 405, 420, 450, 470, 500		331/333/	→4307551 SNL			
			346/368/	Fg.Nr. 1204128 SSS→,			0 265 050 145 ⁴
			390	4338839 SNL→,			
				9003735 SAN→			

Serie 144



	R 460, 530	01.96-08.01	338/389/390	FBA,RAB	0 265 050 145 ⁴
	T 460, 530				





SEAT

















Inca

	1.6 EFI	11.98→	66		1987 476 415	435	
	1.6 EFI	11.98→	66		1987 476 169	425	
	1.6 EFI	11.98→	66		0986 475 039	↔ 20,64	
	1.6 EFI	11.98→	66		F 026 003 563	22	

Inca [6K9]

	1.4 1.6 1.7 D 1.9 D, SDI	11.95-06.03	42/44/47/ 55		1987 476 415	435	
	1.4 1.6 1.7 D 1.9 D, SDI	11.95-06.03	42/44/47/ 55	PR-Nr. 1LL, PR-Nr. 1LY, PR-Nr. 1ZK	0986 471 669 0986 473 669 0986 472 669 0986 474 669	← 54 → 54	1987 470 287 ⁷ 1987 470 287 ⁷
	1.4 1.6 1.7 D 1.9 D, SDI	11.95-06.03	42/44/47/ 55		1987 476 169	425	
	1.4 1.6 1.7 D 1.9 D, SDI	11.95-06.03	42/44/47/ 55		0986 475 039	↔ 20,64	



		S							
	 								
	1.4	ABO	11.95-12.97	44			F 026 003 563	22	
			11.95-06.03	44		LLE	0 986 480 987	23,8	
			09.97-07.98	44	Fg.Nr. →9K..X..006 000	RLE	F 026 003 563	22	
			09.97-06.03	44		LLE	F 026 003 563	22	
			08.98-06.03	44	Fg.Nr. 9K..X..006 001→	RLE	0 204 123 521	22,21	
			09.00-06.03	44		RLE	0 204 123 521	22,21	
				55		LLE	F 026 003 563	22	
							0 986 480 987	23,8	
						RLE	0 204 123 521	22,21	
	1.6	ABO	11.95-05.97	55			F 026 003 563	22	
			11.95-09.00	55		LLE	0 986 480 987	23,8	
			06.97-07.98	55	Fg.Nr. →9K..X..006 000	RLE	F 026 003 563	22	
			06.97-09.00	55		LLE	F 026 003 563	22	
			08.98-09.00	55	Fg.Nr. 9K..X..006 001→	RLE	0 204 123 521	22,21	
	1.7 D	ABO	09.96-07.98	42	Fg.Nr. →9K..X..006 000	RLE	F 026 003 563	22	
			09.96-09.00	42		LLE	F 026 003 563	22	
							0 986 480 987	23,8	
			08.98-09.00	42	Fg.Nr. 9K..X..006 001→	RLE	0 204 123 521	22,21	
	1.9 D	ABO	11.95-07.98	47	Fg.Nr. →9K..X..006 000	RLE	F 026 003 563	22	
			11.95-06.03	47		LLE	F 026 003 563	22	
							0 986 480 987	23,8	
			08.98-06.03	47	Fg.Nr. 9K..X..006 001→	RLE	0 204 123 521	22,21	
	1.9 SDI	ABO	12.95-07.98	47	Fg.Nr. →9K..X..006 000	RLE	F 026 003 563	22	
			12.95-06.03	47		LLE	F 026 003 563	22	
							0 986 480 987	23,8	
			08.98-09.00	47	Fg.Nr. 9K..X..006 001→	RLE	0 204 123 521	22,21	
			09.00-06.03	47		RLE	0 204 123 521	22,21	
	1.4	ABO	11.95-06.03	42/44/47/		RLE	0 204 125 263		
	1.6			55					
	1.7 D								
	1.9 D, SDI								
	1.9 SDI		09.00-06.03	47		LLE	0 986 486 109		
	1.9 SDI		09.00-06.03	47			0 986 486 542		
	1.4		11.95-06.03	42/44/47/			0 204 031 290 ¹⁰		
	1.6			55					
	1.7 D								
	1.9 D, SDI								
	1.4		11.95-06.03	42/44/47/			1 987 477 626	↔ 1671	
	1.6			55					
	1.7 D								
	1.9 D, SDI								
	1.4		11.95-06.03	42/44/47/		LAB	0 986 594 001 ³		
	1.6			55		RAB	0 986 594 000 ³		
	1.7 D								
	1.9 D, SDI								



Terra

	0.9 1.3D 1.4D	01.87-12.94	29/33/35	BSY	0986 473 104 0986 474 104	← 48 → 48
	0.9 1.3D 1.4D	01.87-12.94	29/33/35		0204 116 402	↔ 22,19
	0.9 1.3D 1.4D	01.87-12.94	29/33/35	BKV BKV	F026 003 180 0204 122 112	20,6 20,64
	0.9 1.3D 1.4D	01.87-12.94	29/33/35		1987 477 792	3170

SKODA

Pick-Up [6U7]

	1.6 MPI 1.9 D 135, i.e.	02.94-07.96 08.96-03.01	40/42/43/47/50/55 40/42/43/47/50/55		1987 476 645 1987 476 317	365 320
	135 MPI 136 i.e.	08.96-03.01 02.94-07.96	40/42/43/47/50/55 40/42/43/47/50/55		1987 476 317 1987 476 645	320 365
	136 MPI	08.96-12.97 08.96-03.01	40/42/43/47/50/55 40/42/43/47/50/55		1987 476 317 1987 476 317	320 320
	1.6 MPI 1.9 D 135, i.e., MPI 136 i.e., MPI	09.91-03.01	40/42/43/ 47/50/55		0986 473 112 0986 474 112	← 53,95 → 53,95
	1.6 MPI 1.9 D 135 135 i.e. 135 MPI 136 i.e.	10.95-03.01 09.91-09.95 09.91-12.97	47/55 40/42/43/50 40/42/43/50		1987 476 012 1987 476 647 1987 476 012	175 235 175
	136 i.e.	08.96-03.01 07.93-09.95 07.93-12.97	40/42/43/50 40/42/43/50 40/42/43/50		1987 476 012 1987 476 647 1987 476 012	175 235 175
	136 MPI	08.96-03.01	40/42/43/50		1987 476 012	175
	1.6 MPI 1.9 D 135, i.e., MPI 136 i.e., MPI	09.91-03.01	40/42/43/ 47/50/55		0986 475 769 0986 475 865	▲ ↔ 19 ↔ 22,19





	1.6 MPI 1.9 D 135 MPI 136 MPI	ABO	10.95-03.01	40/47/50/ 55		0 986 480 682	22,19
--	--	-----	-------------	-----------------	--	---------------	-------

	1.6 MPI 135, i.e., MPI 136 i.e., MPI		09.91-03.01	40/42/43/ 50/55		0 986 482 007 ¹⁰	
--	--	--	-------------	--------------------	--	-----------------------------	--

	1.6 MPI 1.9 D 135		10.95-03.01	47/55		1 987 477 680	1392
			09.91-12.92	40/42/43		1 987 477 523	1757
			01.93-12.97	40/42/43		1 987 477 680	1392
	135 i.e., MPI 136 i.e., MPI		07.93-03.01	40/50		1 987 477 680	1392

SSANGYONG

Istana



	2.9 D Van CPU		04.95-06.03	70		1 267 000 814 ¹⁶	
--	------------------	--	-------------	----	--	-----------------------------	--

	2.9 D Van		04.95-06.03	70		0 265 006 341 ⁴	
--	-----------	--	-------------	----	--	----------------------------	--

Istana [L]



	2.3 i16V CPU		11.96→	110		1 267 000 814 ¹⁶	
--	-----------------	--	--------	-----	--	-----------------------------	--

	2.3 i16V		11.96→	110		0 265 006 341 ⁴	
--	----------	--	--------	-----	--	----------------------------	--

SUBARU

Libero [KJ]



	1.2 4WD		10.86-04.93	38		1 987 476 931	→ 264
--	---------	--	-------------	----	--	---------------	-------





SUZUKI

Carry [ED]



	1.0	10.85-09.93	33	Fg.Nr. →*120000	0986 473 399	← 51
--	-----	-------------	----	-----------------	--------------	------

Carry [FD]



	1.3 16V	03.99-03.09	58		0986 475 964	→ 19
					0986 475 965	← 19

Carry Van [ED]



	1.0	10.85-09.93	33	Fg.Nr. →*120000	0986 473 399	← 51
--	-----	-------------	----	-----------------	--------------	------

SJ 410



	1.0	01.87-12.88	33		1987 476 772	280
--	-----	-------------	----	--	--------------	-----



	1.0	10.86-12.86	33		0986 475 728	← 22,19
					0986 475 729	→ 22,19
		01.87-12.88	33		0986 475 858	← 22,19
					0986 475 859	→ 22,19

SJ 410 Pickup



	1.0	01.87-12.88	33		1987 476 772	280
--	-----	-------------	----	--	--------------	-----



	1.0	01.87-12.88	33		0986 475 858	← 22,19
					0986 475 859	→ 22,19





TALBOT

Express [J 5]

	1.9D	07.87-12.93	51/72	Fg.Nr. 0154462→	0 986 473 776	← 38
	2.0				0 986 473 777	→ 38
	2.5D Turbo	07.87-12.93	70		0 986 473 779	→ 43
				CSA	0 986 473 778	← 43

	1.9D	07.87-12.93	51/70/72	Fg.Nr. 0077160→	0 986 475 420	↔ 25,4
	2.0					
	2.5D Turbo					

	1.9D	07.87-12.93	51/70/72		F 026 003 150	22,19
	2.0					
	2.5D Turbo					

TATRA

Serie 815

	T 815-2	06.91→	210		0 265 050 014	

TOYOTA

Dyna 100

	1.8	09.85-05.95	53/55/57		0 986 473 129	← 60,23
	2.5D				0 986 474 129	→ 60,23

	1.8	08.87-05.95	53/55/57		1 987 476 551	485
	2.5D					

	1.8	08.87-03.92	57		0 986 475 845	↔ 20,6	
		08.87-05.95	57		0 986 475 657	↔ 23,8	
					SBR	0 986 475 876	↔ 22,19
					TBR	0 986 475 845	↔ 20,6
	2.5D	08.87-05.95	53		0 986 475 657	↔ 23,8	
			55		SBR	0 986 475 876	↔ 22,19
				TBR	0 986 475 845	↔ 20,6	





Hiace

	1.8 (LWB)	12.85-12.07	58/65/70/	0986 473 129	← 60,23
	2.0 Super 10		75	0986 474 129	→ 60,23
	2.2, Commuter				
	2.2 Super 16 & 12 Commuter				

	1.8 (LWB)	11.86-04.88	58	0986 475 845	↔ 20,6

Hiace [KLH]

	2.5 D Turbo	08.01→	65/75	0986 473 224	← 67
	2.5 D Turbo 4x4			0986 474 224	→ 67

Hiace [LH]

	2.4D	09.85-08.89	62	0986 473 129	← 60,23
				0986 474 129	→ 60,23
	2.4D	09.85-08.89	62	0986 475 657	↔ 23,8
	2.4D 4x4	08.86-08.89	62	0986 475 877	↔ 25,4

Hiace [LXH]

	2.4D	08.95-08.01	62/66	0986 473 224	← 67
	2.4D Turbo			0986 474 224	→ 67

Hiace [RCH]

	2.4	03.97→	85/105	0986 473 224	← 67
	2.4i			0986 474 224	→ 67
	2.7				

Hiace Van

	2.0	12.85-12.87	65	0986 473 129	← 60,23
				0986 474 129	→ 60,23
	2.2	11.92-03.97	70	0986 473 129	← 60,23
				0986 474 129	→ 60,23





Hiace Van [LH]

	2.4D	08.89-08.93	58/62		1 987 481 040	374
	2.4D 4x4					← 374
	2.8D				1 987 481 042	→
		09.93-01.05	58/62		1 987 481 036	380
						← 380
					1 987 481 037	→ 380
	2.4D	05.94-03.97	62	TW	0 986 473 224	← 67
					0 986 474 224	→ 67
		04.97-08.04	62	TW	0 986 473 224	← 67
					0 986 474 224	→ 67
		04.97-01.05	62	TW	0 986 473 224	← 67
					0 986 474 224	→ 67
	2.4D 4x4	08.89-08.95	62		0 986 473 224	← 67
					0 986 474 224	→ 67
	2.8D	08.89-08.00	58		0 986 473 224	← 67
				0 986 474 224	→ 67	



	2.4D	08.89-07.96	62	STB	0 986 475 657	↔ 23,8
				TBR	0 986 475 727	↔ 23,8
	2.4D 4x4	08.89-08.95	62		0 986 475 657	↔ 23,8
	2.8D	08.89-07.96	58		0 986 475 657	↔ 23,8







































Hiace Van [ZH]

	2.0	09.93-02.06	74/84/88		1 987 481 036	380
	2.4, i					← 380
	2.4 i 4WD				1 987 481 037	→ 380
	2.0	08.89-07.95	74/84/88		0 986 475 657	↔ 23,8
	2.4, i, i 4WD					

Hiace Wagon [LH]

	2.4D	08.89-08.93	62		1 987 481 040	374
						← 374
					1 987 481 042	→
		08.89-02.06	62	TW	1 987 481 036	380
						← 380
					1 987 481 037	→ 380
					1 987 481 040	374
						← 374
					1 987 481 042	→
	09.93-08.04	62		1 987 481 036	380	
					← 380	
				1 987 481 037	→ 380	



		S								
TOYOTA Hiace Wagon [LH]										
	2.8D	08.89-08.93	58				1987 481 040	374		
								← 374		
							1987 481 042	→		
	09.93-08.00	58						1987 481 036	380	
									← 380	
								1987 481 037	→ 380	
3.0D	08.98-02.06	65/75					1987 481 036	380		
								← 380		
								1987 481 037	→ 380	
	2.4D	05.94-03.97	62		TW		0986 473 224	 ← 67		
							0986 474 224	 → 67		
		04.97-08.04	62		TW		0986 474 224	 → 67		
		04.97-02.06	62		TW		0986 473 224	 ← 67		
							0986 474 224	 → 67		
	2.8D	08.89-08.00	58				0986 473 224	 ← 67		
						0986 474 224	 → 67			
3.0D	08.98-02.06	65/75			TW		0986 473 224	 ← 67		
							0986 474 224	 → 67		
										
	2.4D	08.89-07.96	62		STB		0986 475 657	 ↔ 23,8		
					TBR		0986 475 727	 ↔ 23,8		
	2.8D	08.89-07.96	58				0986 475 657	 ↔ 23,8		
Hiace Wagon [ZH]										
										
	2.4i	09.93-09.02	88				1987 481 036	380		
								← 380		
								1987 481 037	→ 380	
										
	2.4i	08.89-07.95	88				0986 475 657	 ↔ 23,8		
Hiace [YH]										
										
	1.8 2.0 2.2, 4WD	09.85-08.89	57/65/69				0986 473 129	 ← 60,23		
							0986 474 129	 → 60,23		
										
	1.8 2.0 2.2 2.2 4WD	09.85-08.89	57/65				0986 475 657	 ↔ 23,8		
							0986 475 657	 ↔ 23,8		
							0986 475 657	 ↔ 23,8		
							0986 475 877	 ↔ 25,4		



Hilux

	2.2, 4x4	02.86-06.94	55/70	0 986 473 129		← 60,23
	2.4D			0 986 474 129		→ 60,23
	3.0TD	01.02-02.05	85	0 986 473 067		← 42,8
				0 986 474 067		→ 42,8
	2.5 16V D Turbo	01.02→	75/85/120	0 204 032 617		
	3.0 TD			0 204 032 620		
	3.0 16V D Turbo Interc.					

Hilux [N5/N6]

	1.6	01.86-07.98	50/58/65/	0 986 473 129		← 60,23
	1.8		75/80	0 986 474 129		→ 60,23
	2.2					
	2.4					
	2.8D					

Hilux Pickup [N8]

	1.8	01.89-10.91	57	1 987 476 943		345
		04.92-10.94	57	1 987 476 943		345
	1.8	01.89-10.94	57	0 986 473 129		← 60,23
				0 986 474 129		→ 60,23
	1.8	01.89-10.94	57	0 986 475 876		↔ 22,19

Hilux Pickup [N8...13]

	1.8	08.88-08.94	57	1 987 476 943		345
	2.4D	08.88-08.97	62	1 987 476 943		345
		01.89-10.91	62	1 987 476 943		345
		04.92-02.97	62	1 987 476 943		345
	1.8	08.88-08.94	57	0 986 473 129		← 60,23
				0 986 474 129		→ 60,23
	2.2 4WD	08.88-08.94	69	0 986 473 067		← 42,8
				0 986 474 067		→ 42,8
	2.4D	08.88-07.97	62	0 986 473 067		← 42,8
				0 986 474 067		→ 42,8
		08.88-08.97	62	0 986 473 129		← 60,23
				0 986 474 129		→ 60,23
	2.4D 4x4	09.88-08.97	62	0 986 473 067		← 42,8
				0 986 474 067		→ 42,8



TOYOTA Hilux Pickup [N8...13]									
	2.4 i4WD	08.88-08.97	84				0986 473 067		← 42,8
	2.4 i4x4						0986 474 067		→ 42,8
Hilux Pickup [N14...19]									
	2.2 4WD	08.88-08.97	62/69/84				1987 476 940		440
	2.4 D, D 4x4, i4WD, i4x4								
	1.8	08.88-08.94	57				0986 475 876		↔ 22,19
	2.2 4WD	08.88-08.94	69				0986 475 894		↔ 22,19
	2.4 D	08.88-07.97	62				0986 475 894		↔ 22,19
		08.88-08.97	62				0986 475 876		↔ 22,19
	2.4 D 4x4	09.88-08.97	62				0986 475 894		↔ 22,19
	2.4 i4WD, i4x4	08.88-08.97	84				0986 475 894		↔ 22,19
Hilux Wagon [N8...13]									
	2.4 D	08.97-08.01	62				0986 473 129		← 60,23
							0986 474 129		→ 60,23
	2.5 D Turbo	08.01-08.05	65/75	Fg.Nr. *KDN145*, Fg.Nr. *KDN150*			0986 473 129		← 60,23
							0986 474 129		→ 60,23
Land Cruiser [70]									
	4.2 D 4x4	05.00→	96				0986 475 877		↔ 25,4
Liteace [M3]									
	1.8 D	10.85-08.86	47		EIZ		1987 476 495		280
Quantum									
	2.5 D-4D	03.05→	75				0986 473 224		← 67
							0986 474 224		→ 67





VAUXHALL

Arena

	1.9D	03.98-08.01	44/55	OE	1 987 476 432	315		
	2.5			UE	1 987 476 032	315		
	2.5D							
	1.9D	03.98-08.01	44/55		0 204 102 052	← 45		
	2.5				0 204 103 052	↻		
	2.5D				0 204 102 054	→ 45		
					0 204 103 054	↻		
	1.9D	03.98-08.01	44/55		1 987 476 700	380		
	2.5							
	2.5D							
	1.9D	03.98-08.01	44/55		1 987 477 662	↔ 747		
		ABO 03.98-08.01	44/55		1 987 477 663	← 1330		
					1 987 477 665	→ 1424		
	ABS	03.98-08.01	44/55		1 987 477 664	← 1295		
					1 987 477 666	→ 1390		
		2.5, D	03.98-08.01	44/55		1 987 477 662	↔ 747	
			ABO 03.98-08.01	44/55		1 987 477 663	← 1330	
				1 987 477 665	→ 1424			
		ABS 03.98-08.01	44/55		1 987 477 664	← 1295		
					1 987 477 666	→ 1390		

Brava Pick-Up [TF0]

	2.2D	02.89-12.96	39/56-74/	AA	1 987 476 911	435	
	2.3, i		80	AA	1 987 476 147	515	
	2.5D, TD						
	3.1TD						
	2.2D	02.89-12.96	39/56-74/	AA	0 986 473 306	↻ ← 60	
	2.3, i		80		0 986 474 306	↻ → 60	
	2.5D, TD						
	3.1TD						
	2.2D	02.89-12.96	39/56-74/		1 987 476 549	466	
	2.3, i		80				
	2.5D, TD						
	3.1TD						
	2.2D	02.89-09.95	39/56-74/		0 986 475 807	↔ 25,4	
	2.3, i		80				
	2.5D, TD						
	3.1TD						



		S				?			
◀ VAUXHALL Brava Pick-Up [TF0]									
	3.1 TD	10.95-12.96	80				0 204	123 508	
Brava Pick-Up [TF1]									
	2.5 TD 3.1 TD	03.97-08.02	56/80			AA AA	1 987 1 987	476 911 476 147	435 515
	2.5 TD 3.1 TD	03.97-08.02	56/80			AA	0 986 0 986	473 306 474 306	← 60 → 60
	2.5 TD 3.1 TD	03.97-08.02	56/80				1 987	476 549	466
	2.5 TD 3.1 TD	03.97-08.02	56/80				0 986	475 807	↔ 25,4
Combo									
	1.2 i 1.4 i 1.7 D	09.94-10.01	33/44/60/ 66				1 987	476 691	340
	1.2 i 1.4 i 1.7 D	09.94-10.01	33/44/60/ 66				0 986 0 986	471 900 473 900	→ 48
						CSA	0 986 0 986	471 899 473 899	← 48
	1.2 i 1.4 i 1.7 D	09.94-10.01	33/44/60/ 66				1 987	476 144	412
	1.2 i 1.4 i 1.7 D	09.94-10.01	33/44/60				0 986	475 045	↔ 22,19
	1.2 i	ABO 09.94-10.01	33			LLE	0 986	480 130	20,6
		ABS 09.94-10.01	33			LLE	0 986	480 818	22
	1.4 i	ABO 09.94-10.01	44/60/66			LLE	0 986	480 130	20,6
		ABS 09.94-10.01	44/60/66			LLE	0 986	480 818	22
	1.7 D	ABO 09.94-10.01	44			LLE	0 986	480 130	20,6
		ABS 09.94-10.01	44			LLE	0 986	480 818	22





	1.2 i 1.4 i 1.7 D	09.94-10.01	33/44/60/ 66			1 987 477 769	1659
	1.2 i 1.4 i 1.7 D	09.94-10.01	33/44/60/ 66	Fg.Nr. T3000001→	BO	0 265 216 410 ¹¹	

Combo [Tour]



	1.3 CDTi 1.4 i Twinport, i Twinport Dualfuel 1.6 CNG, i 1.7 CDTi, DI, DTI	09.01→	48/51/55/ 64/65/66/ 69-71/74			1 987 476 202	
--	--	--------	------------------------------------	--	--	---------------	--

	1.6 CNG 1.7 CDTi	09.04→	69-71/74			0 986 473 062	↻ ← 57	1 987 470 005 ⁷
						0 986 474 062	↻ → 57	1 987 470 005 ⁷



	1.3 CDTi 1.4 i Twinport, i Twinport Dualfuel 1.6 CNG, i 1.7 CDTi, DI, DTI	09.01→	48/51/55/ 64/65/66/ 69-71/74			1 987 476 904	245
--	--	--------	------------------------------------	--	--	---------------	-----

	1.3 CDTi 1.4 i Twinport, i Twinport Dualfuel 1.6 i 1.7 CDTi, DI, DTI	09.01→	48/51/55/ 64/65/66/ 74			0 986 475 143	↔ 19,05
--	---	--------	------------------------------	--	--	---------------	---------

















	1.3 CDTi 1.4 i Twinport, i Twinport Dualfuel 1.6 CNG	01.04→	51/55/65/ 66/69-71			0 986 473 258	↻ ← 38	
						0 986 474 258	↻ → 38	
	1.6 i	10.01-08.04	64			0 986 473 256	↻ ←	
						0 986 474 256	↻ →	
	1.7 CDTi	09.04→	74			0 986 473 258	↻ ← 38	
						0 986 474 258	↻ → 38	
	1.7 DI	09.01-08.04	48/55			0 986 473 256	↻ ←	
	1.7 DTI					0 986 474 256	↻ →	



	1.3 CDTi	ABO 09.04→	51/55			0 204 123 662	22,19
		ESP 09.04→	51/55		STB	0 204 123 639	22,19
					4SB	0 204 123 637	23,8
		OFD 09.04→	51/55		STB	0 204 123 640	22,19
					4SB	0 204 123 638	23,8
	1.4 i Twinport	ABO 01.04→	65/66			0 204 123 662	22,19
	1.4 i Twinport Dualfuel	ESP 01.04→	65/66		STB	0 204 123 639	22,19
					4SB	0 204 123 637	23,8
		OFD 01.04→	65/66		STB	0 204 123 640	22,19
					4SB	0 204 123 638	23,8



		S								
◀ VAUXHALL Combo [Tour]										
1.6 CNG	ABO	04.05→	69-71	Fg.Nr. 43000001→			0 204 123 662	22,19		
				Fg.Nr. 43000001→,	STB		0 204 123 659	22,19		
				44000001→, 46000001→						
				Fg.Nr. 44000001→,	STB		0 204 123 659	22,19		
				46000001→						
	ESP	04.05→	69-71	Fg.Nr. 43000001→,			0 204 123 637	23,8		
			44000001→, 46000001→	STB		0 204 123 639	22,19			
OFD	04.05→	69-71	Fg.Nr. 43000001→,			0 204 123 638	23,8			
			44000001→, 46000001→	STB		0 204 123 640	22,19			
1.6 i		10.01-08.04	64			DMO	0 986 480 859	22		
1.7 CDTi	ABO	09.04→	74				0 204 123 662	22,19		
	ESP	09.04→	74			STB	0 204 123 639	22,19		
						4SB	0 204 123 637	23,8		
	OFD	09.04→	74			STB	0 204 123 640	22,19		
						4SB	0 204 123 638	23,8		
1.7 DI, DTI		09.01-08.04	48/55			DMO	0 986 480 859	22		
	1.3 CDTi	ABO	09.04→	51/55			0 204 125 812			
		ABS	09.04→	51/55			0 204 125 813			
	1.4 i Twinport	ABO	01.04→	65/66			0 204 125 812			
	1.4 i Twinport Dualfuel	ABS	01.04→	65/66			0 204 125 813			
1.6 CNG	ABO	04.05→	69-71	Fg.Nr. 43000001→,			0 204 125 812			
				44000001→, 46000001→						
	ABS	04.05→	69-71	Fg.Nr. 43000001→,			0 204 125 813			
				44000001→, 46000001→						
1.7 CDTi	ABO	09.04→	74				0 204 125 812			
	ABS	09.04→	74				0 204 125 813			
	1.3 CDTi		09.04→	51/55		STB	1 987 477 869	↔ 1238		
		ABO	09.04→	51/55		4SB	1 987 477 869	↔ 1238		
		ABS	09.04→	51/55		4SB	1 987 482 138	↔ 2067		
1.4 i Twinport, i Twinport Dualfuel		01.04→	65/66		STB	1 987 477 869	↔ 1238			
	ABO	01.04→	65/66		4SB	1 987 477 869	↔ 1238			
	ABS	01.04→	65/66		4SB	1 987 482 138	↔ 2067			
1.6 CNG		04.05→	69-71		STB	1 987 477 869	↔ 1238			
	ABO	04.05→	69-71		4SB	1 987 477 869	↔ 1238			
	ABS	04.05→	69-71		4SB	1 987 482 138	↔ 2067			
1.6 i		10.01-08.04	64			1 987 477 869	↔ 1238			
1.7 CDTi		09.04→	74		STB	1 987 477 869	↔ 1238			
	ABO	09.04→	74		4SB	1 987 477 869	↔ 1238			
	ABS	09.04→	74		4SB	1 987 482 138	↔ 2067			
1.7 DI, DTI		09.01-08.04	48/55			1 987 477 869	↔ 1238			
	1.3 CDTi		01.04→	51/55/65/66		EAY	0 265 231 444 ¹¹			
		1.4 i Twinport			Fg.Nr. →43999999,	GS	0 265 231 307 ¹¹			
	1.4 i Twinport Dualfuel				→44999999, →46999999					
					Fg.Nr. 53000001→,	GS	0 265 231 584 ¹¹			
			54000001→, 56000001→							
1.6 CNG		04.05→	69-71	Fg.Nr. 53000001→,			0 265 231 584 ¹¹			
				54000001→, 56000001→						
1.7 CDTi		09.04→	74			EAY	0 265 231 444 ¹¹			
					Fg.Nr. →43999999,	GS	0 265 231 307 ¹¹			
					→44999999, →46999999					
					Fg.Nr. 53000001→,	GS	0 265 231 584 ¹¹			
				54000001→, 56000001→						
	1.3 CDTi		09.01→	48/51/55/64/65/66/69-71/74			0 986 594 027 ³			
		1.4 i Twinport, i Twinport Dualfuel								
			1.6 CNG, i							
				1.7 CDTi, DI, DTI						

		S							
	1.6 CNG	04.05→	69-71				0 265 005 303		
Movano									
	 								
	1.9 D	01.99-10.01	59			OE,STB	1 987 476 906	565	
						STB,UE	1 987 476 907	610	
						4SB,OE	1 987 481 150	507	
						4SB,UE	1 987 481 151	538	
	1.9 DTI	10.01-08.03	60	Fg.Nr. →3V999999, →3Y999999		OE,STB	1 987 476 906	565	
						STB,UE	1 987 476 907	610	
						4SB,UE	1 987 481 151	538	
				Fg.Nr. →3Y999999, →3V999999		4SB,OE	1 987 481 150	507	
		10.01-10.05	60			OE,STB	1 987 476 906	565	
						STB,UE	1 987 476 907	610	
						4SB,OE	1 987 481 150	507	
						4SB,UE	1 987 481 151	538	
		09.03-10.05	60	Fg.Nr. 4V000001→, 4Y000001→			1 987 481 186	545	
	2.2 DTI	10.98→	59/66/			OE,STB	1 987 476 906	565	
	2.5 D		74-84			STB,UE	1 987 476 907	610	
	2.5 DTI					4SB,OE	1 987 481 150	507	
						4SB,UE	1 987 481 151	538	
	2.5 DTI	10.01-03.07	84			OE,STB	1 987 476 906	565	
						STB,UE	1 987 476 907	610	
						4SB,OE	1 987 481 150	507	
						4SB,UE	1 987 481 151	538	
		10.03-03.07	84	Fg.Nr. 4V000001→, 4Y000001→			1 987 481 186	545	
		08.06→	74-88 107				1 987 481 186	545	
							1 987 481 186	545	
	2.8 DTI	06.98-10.05	84			OE,STB	1 987 476 906	565	
						STB,UE	1 987 476 907	610	
						4SB,OE	1 987 481 150	507	
						4SB,UE	1 987 481 151	538	
	3.0 DTI	10.03-10.05	100	Fg.Nr. 4V000001→, 4Y000001→			1 987 481 186	545	
	1.9 D	06.98→	59/60/66/			15Z	0 204 102 730	← 45	
	1.9 DTI		74-88/100/				0 204 103 730	↻	
	2.2 DTI		107				0 204 102 731	→ 45	
	2.5 D, DTI						0 204 103 731	↻	
	2.8 DTI					16Z	0 986 473 328	↻ ← 45	
	3.0 DTI						0 986 474 328	↻ → 45	
	 								
	1.9 D	01.99-10.01	59			LF	1 987 476 905 ¹	435	
						4SB	1 987 481 152	358	
	1.9 DTI	10.01-08.03	60	Fg.Nr. →3V999999, →3Y999999			1 987 481 152	358	
		10.01-10.05	60			LF	1 987 476 905 ¹	435	
						4SB	1 987 481 152	358	
		09.03-10.05	60	Fg.Nr. 4V000001→, 4Y000001→			1 987 481 057	→ 492	
							1 987 481 074	← 480	
	2.2 DTI	10.98→	59/66/			LF	1 987 476 905 ¹	435	
	2.5 D, DTI		74-84			4SB	1 987 481 152	358	



VAUXHALL Movano							
2.5 DTI	10.01-03.07	84		LF	1987 476 905¹	435	
				4SB	1987 481 152	358	
	10.03-03.07	84	Fg.Nr. 4V000001→, 4Y000001→		1987 481 057	→ 492	
					1987 481 074	← 480	
	08.06→	74-88			1987 481 057	→ 492	
					1987 481 074	← 480	
		107			1987 481 057	→ 492	
					1987 481 074	← 480	
	2.8 DTI	06.98-10.05	84		LF	1987 476 905¹	435
					4SB	1987 481 152	358
3.0 DTI	10.03-10.05	100	Fg.Nr. 4V000001→, 4Y000001→	LF	1987 476 905¹	435	
					1987 481 057	→ 492	
					1987 481 074	← 480	

1.9 D, DTI 2.2 DTI 2.5 D, DTI 2.8 DTI 3.0 DTI	06.98→	59/60/66/ 74-84/100			F 026 002 532	← 23,8
					F 026 002 533	→ 23,8

1.9 D 1.9 DTI 2.2 DTI 2.5 D, DTI 2.8 DTI 3.0 DTI	01.99-10.01	59			0 204 004 320	← 42
					0986 473 260	
					0 204 004 321	→ 42
					0986 474 260	
	10.01-08.03	60			0 204 004 320	← 42
					0986 473 260	
					0 204 004 321	→ 42
					0986 474 260	
	10.01-10.05	60			0 204 004 320	← 42
					0986 473 260	
					0 204 004 321	→ 42
					0986 474 260	
	09.03-10.05	60			0 204 004 320	← 42
					0986 473 260	
					0 204 004 321	→ 42
				0986 474 260		

1.9 D, DTI 2.2 DTI 2.5 D, DTI 2.8 DTI 3.0 DTI	06.98→	59/60/66/ 74-88/100/ 107			1987 482 012	↔ 1175
				ABM	1987 477 261	1737
					1987 482 013	↔ 1420

Vivaro 						
1.9 DI, DTI 2.0 CDTI, 16V 2.5 CDTI, DTI	03.01→	59-60/66/74/84/ 86-88/99/107			1987 476 700	380
	1.9 DI, DTI 2.0 CDTI, 16V 2.5 CDTI, DTI	03.01→	59-60/66/ 74/84/ 86-88/99/107	Fg.Nr. →6V699999, →6Y999999	0986 473 424	← 45
					0986 474 424	→ 45



	1.9 DI, DTI	03.01→	59-60/66/74/84/		1 987 476 914	222	
	2.0 CDTI, 16V		86-88/99/107				
	2.5 CDTI, DTI						



	1.9 DI	03.01-08.06	59-60/74	LLE	0 986 480 887	20,6	
	1.9 DTI			RLE	0 986 480 831	25,4	
	2.0 16V	03.01→	86-88		0 986 480 831	25,4	
	2.5 DTI	ESP 04.04-08.06	99		0 986 480 827	25,4	
		OFD 04.04-08.06	99	Fg.Nr. →4V602167 Fg.Nr. 4V602168→	0 986 480 831 0 986 480 828	25,4 25,4	

	1.9 DI	03.01→	59-60/66/		1 987 477 116	→ 1603	
	1.9 DTI		74/84/		1 987 477 137	← 1503	
	2.0 CDTI		86-88/99/	FKR,MI	1 987 482 043	1190	
	2.0 16V		107	FLR,MI	1 987 482 145	1923	
	2.5 CDTI			LLE	1 987 482 042	508	
	2.5 DTI			RLE	1 987 482 146	2198	

	1.9 DI, DTI	03.01→	59-60/66/	Fg.Nr. 7V600001→,	0 265 008 077 ³		
	2.0 CDTI, 16V		74/84/	7Y000001→			
	2.5 CDTI, DTI		86-88/99/107				

VW (VOLKSWAGEN)

Bus [24, 25]



	1.6 D Turbo Syncro	03.86-07.92	51		1 987 476 139	440	
	1.7 D	10.86-07.92	42	BMS	1 987 476 139	440	
				FES	1 987 476 138	380	
	1.9	08.86-10.88	54	BMS	1 987 476 139	440	
				FES	1 987 476 138	380	
	1.9 Syncro	10.86-10.88	54		1 987 476 139	440	
	2.1	08.85-07.92	64/68/70/ 82	BMS	1 987 476 139	440	
				FES	1 987 476 138	380	
2.1 Syncro	08.85-07.92	64/70/82		1 987 476 139	440		

	1.6 D Turbo Syncro	03.86-07.92	51	LUC	0 986 471 668	← 60	1 987 470 048 ⁷
					0 986 473 668	↻	
					0 986 472 668	→ 60	1 987 470 048 ⁷
					0 986 474 668	↻	
	1.7 D	10.86-07.92	42	FSB,GIR	0 986 471 668	← 60	1 987 470 048 ⁷
					0 986 473 668	↻	
					0 986 472 668	→ 60	1 987 470 048 ⁷
					0 986 474 668	↻	
	1.9	08.86-10.88	54	FSB,GIR	0 986 471 668	← 60	1 987 470 048 ⁷
					0 986 473 668	↻	
					0 986 472 668	→ 60	1 987 470 048 ⁷
					0 986 474 668	↻	
	1.9 Syncro	10.86-10.88	54	LUC	0 986 471 668	← 60	1 987 470 048 ⁷
					0 986 473 668	↻	
					0 986 472 668	→ 60	1 987 470 048 ⁷
					0 986 474 668	↻	



◀ VW Bus [24, 25]									
	2.1	08.85-07.92	64/68/70/ 82	FSB,GIR		0986 471 668	← 60	1987 470 048 '	
						0986 473 668			
	2.1 Syncro	08.85-07.92	64/70/82	LUC		0986 471 668	← 60	1987 470 048 '	
						0986 473 668			
	2.1 Syncro	08.85-07.92	64/70/82			0986 472 668	→ 60	1987 470 048 '	
						0986 474 668			
	1.6 D Turbo Syncro	08.85-07.92	42/51/54/			1987 476 216	180		
	1.7 D		64/68/70/						
	1.9, Syncro		82						
	2.1, Syncro								
	1.7 D	08.85-07.92	42/54/64/			F 026 002 305	↔ 23,8		
	1.9		68/70/82						
	2.1								
	1.6 D Turbo Syncro	03.86-07.92	51		BKV	0 204 123 029	23,8		
					FBM	0986 480 641	23,8		
	1.7 D	08.86-07.92	42/54/64/68/70/82		FBM	0986 480 641	23,8		
	1.9				FBM	0 204 123 029	23,8	1987 472 294	
	1.9 Syncro	10.86-10.88	42/54/64/68/70/82		FBM	0986 480 641	23,8		
	2.1	08.85-07.92	42/54/64/68/70/82		FBM	0986 480 641	23,8		
					FBM	0 204 123 029	23,8	1987 472 294	
	2.1 Syncro	08.85-07.92	70/82		BKV	0 204 123 029	23,8		
	1.6 D Turbo Syncro	03.86-07.92	51			0986 485 103			
	1.7 D	10.86-07.92	42	Fg.Nr. 24-A-000 001→	ATE	0986 485 103			
	1.9	08.86-10.88	54	Fg.Nr. 24-A-000 001→	ATE	0986 485 103			
	1.9 Syncro	10.86-10.88	54			0986 485 103			
	2.1	08.85-07.92	64/68/70/ 82	Fg.Nr. 24-A-000 001→	ATE	0986 485 103			
	2.1 Syncro	08.85-07.92	64/70/82			0986 485 103			
		1.6 D Turbo Syncro	08.85-07.92	42/51/54/			0986 486 002		
		1.7 D		64/68/70/					
1.9, Syncro			82						
2.1, Syncro									
	1.6 D Turbo Syncro	08.85-07.92	42/51/54/			0986 486 507			
	1.7 D		64/68/70/						
	1.9, Syncro		82						
	2.1, Syncro								
	1.6 D Turbo Syncro	03.86-07.92	51		14Z	1987 482 215	← 1882		
						1987 482 216	→ 1083		
					16Z	1987 482 217	← 1534		
						1987 482 218	→ 1477		
	1.7 D	10.86-07.92	42			1987 477 040	↔ 1475		
	1.9	08.86-10.88	54			1987 477 040	↔ 1475		
	1.9 Syncro	10.86-10.88	54		14Z	1987 482 215	← 1882		
						1987 482 216	→ 1083		
					16Z	1987 482 217	← 1534		
						1987 482 218	→ 1477		
2.1	08.85-07.92	64/68/70/82			1987 477 040	↔ 1475			

		S							
2.1 Syncro		08.85-07.92	64/70/82			14Z	1 987 482 215	← 1882	
						16Z	1 987 482 216	→ 1083	
							1 987 482 217	← 1534	
							1 987 482 218	→ 1477	

	1.6 D, D Turbo 1.7 D 1.9 2.1	08.85-07.92	37/42/44/ 51/57/82				0 265 103 023 ¹⁶		
--	---------------------------------------	-------------	-----------------------	--	--	--	------------------------------------	--	--

	1.6 D, D Turbo 1.7 D 1.9 2.1	08.85-07.92	37/40/42/ 44/51/54/ 57/64/68/ 70/82				0 265 001 151 ⁴		
--	---------------------------------------	-------------	--	--	--	--	-----------------------------------	--	--

Caddy Pickup [9U7]

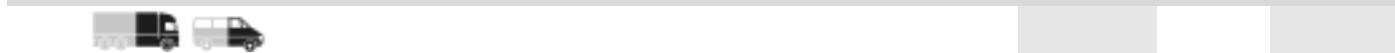

	1.6 1.9D	06.96-12.00	47/55				1 987 476 317	320	
--	-------------	-------------	-------	--	--	--	----------------------	-----	--

	1.6 1.9D	06.96-12.00	47/55				0 986 473 112	← 53,95	1 987 470 507 ^B
							0 986 474 112	→ 53,95	1 987 470 507 ^B



	1.6 1.9D	06.96-12.00	47/55				1 987 476 012	175	
--	-------------	-------------	-------	--	--	--	----------------------	-----	--

	1.6 1.9D	ABO 06.96-12.00	47/55				0 986 475 865	↔ 22,19	
--	-------------	-----------------	-------	--	--	--	----------------------	---------	--



	1.6 1.9D	ABO 06.96-12.00	47/55				0 986 480 682	22,19	
--	-------------	-----------------	-------	--	--	--	----------------------	-------	--

	1.6 1.9D	06.96-12.00	47/55				0 986 482 007 ¹⁰		
--	-------------	-------------	-------	--	--	--	------------------------------------	--	--

	1.6 1.9D	06.96-12.00	47/55				1 987 477 690	1762	
--	-------------	-------------	-------	--	--	--	----------------------	------	--

	1.6 1.9D	06.96-12.00	47/55				0 986 594 004 ⁴		
--	-------------	-------------	-------	--	--	--	-----------------------------------	--	--

Caddy Pickup [14, 1A]



	1.6D 1.8	08.85-07.92	40/70				1 987 476 217	310	
--	-------------	-------------	-------	--	--	--	----------------------	-----	--



		S							
◀ VW Caddy Pickup [14, 1A]									
	1.6 D	08.85-07.92	40/70				0986 473 663	← 48	0 204 104 144 ⁷
	1.8						0986 474 663	→ 48	0 204 104 144 ⁷
	1.6	08.87-07.92	55	Fg.Nr. 14-H-011 049→			0986 475 433	↔ 19,05	
	1.6 D	08.87-07.90	40	Fg.Nr. 14-H-011 049→			0986 475 433	↔ 19,05	
		08.90-07.92	40				0986 475 433	↔ 19,05	
	1.8	08.85-07.87	70	Fg.Nr. →14-H-011 048			0986 475 260	↔ 17,46	
		08.87-07.92	70	Fg.Nr. 14-H-011 049→			0986 475 433	↔ 19,05	
	1.6	07.91-07.92	55	Fg.Nr. 14-N-000001→	LLE	F 026 003 562	20,6		
					RLE	0986 480 428	20,64		
	1.6 D	08.90-07.91	40/70	Fg.Nr. →14-M-010000	FWA	0986 480 430	20,64	1987 472 181	
					LLE	0986 480 428	20,64		
		07.91-07.92	40/70	Fg.Nr. 14-N-000001→	LLE	F 026 003 562	20,6		
					RLE	0986 480 428	20,64		
	1.8	08.85-07.91	40/70	Fg.Nr. →14-M-010000	FWA	0986 480 430	20,64	1987 472 181	
					LLE	0986 480 428	20,64		
		07.91-07.92	40/70	Fg.Nr. 14-N-000001→	LLE	F 026 003 562	20,6		
					RLE	0986 480 428	20,64		
	1.6 D	08.85-07.92	40/70				0 204 031 319 ¹⁰		
	1.8								
	1.6 D	08.85-07.92	40/70				1987 477 322	2033	
	1.8								
Caddy [2K]									
	1.4	02.04-05.08	51/55/59/				1987 476 282	577	
	1.6		75/77/80/						
	1.9 TDI		103						
	2.0 Eco Fuel, SDI, TDI								
	1.4	02.04-05.08	55/59/75/	77	228	0986 473 071	← 54	1987 470 506 ⁸	
						0986 474 071	→ 54	1987 470 506 ⁸	
	1.6				288	0986 473 384	← 53,93	1987 470 506 ⁸	
						0986 474 384	→ 53,93	1987 470 506 ⁸	
	1.9 TDI				288,312	0986 473 384	← 53,93	1987 470 506 ⁸	
						0986 474 384	→ 53,93	1987 470 506 ⁸	
	2.0 Eco Fuel	04.06-05.08	80		228	0986 473 071	← 54	1987 470 506 ⁸	
						0986 474 071	→ 54	1987 470 506 ⁸	
	2.0 SDI	02.04-05.08	51		288	0986 473 384	← 53,93	1987 470 506 ⁸	
						0986 474 384	→ 53,93	1987 470 506 ⁸	
2.0 TDI	09.07-05.08	103		288,312	0986 473 384	← 53,93	1987 470 506 ⁸		
					0986 474 384	→ 53,93	1987 470 506 ⁸		
	1.4	02.04-05.08	51/55/59/				1987 476 398	525	
	1.6		75/77/80/						
	1.9 TDI		103						
	2.0 Eco Fuel, SDI, TDI								



	1.4	02.04-05.06	55			1987 470 040 ⁷
		05.06-10.07	59	Fg.Nr. →2K..8..060 000		1987 470 040 ⁷
		11.07-05.08	59	Fg.Nr. 2K..8..060 001→		1987 470 040 ⁷
1.6	04.04-05.05	75			1987 470 040 ⁷	
	06.05-10.07	75	Fg.Nr. →2K..8..060 000		1987 470 040 ⁷	
	11.07-05.08	75	Fg.Nr. 2K..8..060 001→		1987 470 040 ⁷	
1.9 TDI	02.04-10.07	55/77	Fg.Nr. →2K..8..060 000		1987 470 040 ⁷	
	11.07-05.08	55/77	Fg.Nr. 2K..8..060 001→		1987 470 040 ⁷	
2.0 Eco Fuel	04.06-05.08	80			1987 470 040 ⁷	
2.0 SDI	02.04-10.07	51	Fg.Nr. →2K..8..060 000		1987 470 040 ⁷	
	11.07-05.08	51	Fg.Nr. 2K..8..060 001→		1987 470 040 ⁷	
2.0 TDI	09.07-05.08	103			1987 470 040 ⁷	



	1.4	02.04-05.06	55	LLE	0 986 480 870	22	
		1.6	04.04-05.05	75	LLE	0 986 480 870	22
			06.05-05.06	75	Fg.Nr. →2K..6..150 000	LLE	0 986 480 870
1.9 TDI	02.04-05.06	51/55/77/	Fg.Nr. →2K..6..150 000	LLE	0 986 480 870	22	
2.0 Eco Fuel, SDI		80					

	1.4	02.04-05.08	51/55/59/	PR-Nr. 0EJ		0 986 486 576
		1.6	75/77/80	PR-Nr. 0E1	FKR	0 986 486 554
			1.9 TDI			
2.0 Eco Fuel, SDI						
2.0 TDI	09.07-05.08	103	PR-Nr. 0E1	FKR	0 986 486 554	

	1.4	02.04-05.08	51/55/59/	FKR	1 987 477 203	↔ 1713
		1.6	75/77/80/			
			1.9 TDI	103		
2.0 Eco Fuel, SDI, TDI						

	1.4	02.04-05.08	51/55/59/	LAB	0 986 594 504 ³	
		1.6	75/77/80/	RAB	0 986 594 505 ³	
			1.9 TDI	103		
2.0 Eco Fuel, SDI, TDI						

Caddy [9K9]



	1.4	11.95-06.03	42/44/47/		1 987 476 415	435
		1.6	55/66			
			1.7 SDI			
1.9 D, SDI, TDI						

	1.4	11.95-06.03	42/44/47/		0 986 471 669	← 54	1987 470 287 ⁷
		1.6	55/66		0 986 473 669	↻	
			1.7 SDI			0 986 472 669	
		1.9 D, SDI, TDI				0 986 474 669	



	1.4	11.95-06.03	42/44/47/		1 987 476 169	425
		1.6	55/66			
			1.7 SDI			
1.9 D, SDI, TDI						

	1.4	11.95-06.03	42/44/47/		0 986 475 039	↔ 20,64
		1.6	55/66			
			1.7 SDI			
1.9 D, SDI, TDI						





◀ VW Caddy [9K9]



	1.4	ABO	11.95-12.97	44			F 026 003 563	22	
			11.97-08.98	44	Fg.Nr. →9K..X..514 000	RLE		F 026 003 563	22
			09.98-06.03	44	Fg.Nr. 9K..X..514 001→	RLE		0 204 123 521	22,21
			09.00-06.03	44		RLE		0 204 123 521	22,21
				55		RLE		0 204 123 521	22,21
		ABS	11.95-06.03	44		LLE		0 986 480 987	23,8
		11.97-06.03	44		LLE		F 026 003 563	22	
		09.00-06.03	55		LLE		F 026 003 563	22	
							0 986 480 987	23,8	
1.6	ABO	11.95-05.97	55				F 026 003 563	22	
		06.97-08.98	55	Fg.Nr. →9K..X..514 000	RLE		F 026 003 563	22	
		09.98-09.00	55	Fg.Nr. 9K..X..514 001→	RLE		0 204 123 521	22,21	
	ABS	11.95-09.00	55		LLE		0 986 480 987	23,8	
		06.97-09.00	55		LLE		F 026 003 563	22	
1.7 SDI	ABO	07.96-08.98	42	Fg.Nr. →9K..X..514 000	RLE		F 026 003 563	22	
		09.98-09.00	42	Fg.Nr. 9K..X..514 001→	RLE		0 204 123 521	22,21	
	ABS	07.96-09.00	42		LLE		F 026 003 563	22	
							0 986 480 987	23,8	
1.9 D	ABO	11.95-08.98	47	Fg.Nr. →9K..X..514 000	RLE		F 026 003 563	22	
		09.98-06.03	47	Fg.Nr. 9K..X..514 001→	RLE		0 204 123 521	22,21	
1.9 D	ABS	11.95-06.03	47		LLE		F 026 003 563	22	
1.9 SDI							0 986 480 987	23,8	
1.9 SDI	ABO	11.95-08.98	47	Fg.Nr. →9K..X..514 000	RLE		F 026 003 563	22	
		09.98-09.00	47	Fg.Nr. 9K..X..514 001→	RLE		0 204 123 521	22,21	
		09.00-06.03	47		RLE		0 204 123 521	22,21	
1.9 TDI	ABO	10.96-03.97	66				F 026 003 563	22	
		12.96-08.98	66	Fg.Nr. →9K..X..514 000	RLE		F 026 003 563	22	
		09.98-09.00	66	Fg.Nr. 9K..X..514 001→	RLE		0 204 123 521	22,21	
		09.00-06.03	66		RLE		0 204 123 521	22,21	
	ABS	10.96-06.03	66		LLE		0 986 480 987	23,8	
		12.96-06.03	66		LLE		F 026 003 563	22	
	1.4	ABO	11.95-06.03	44/55		RLE	0 204 125 263		
		ABS	11.95-06.03	44		LLE	0 204 125 262		
			09.00-06.03	55		LLE	0 204 125 262		
1.6	ABO	11.95-09.00	55		RLE	0 204 125 263			
	ABS	11.95-09.00	55		LLE	0 204 125 262			
1.7 SDI	ABO	07.96-09.00	42/47/66		RLE	0 204 125 263			
	ABS	07.96-09.00	42/47/66		LLE	0 204 125 262			
1.9 D, SDI, TDI	ABO	11.95-06.03	42/47/66		RLE	0 204 125 263			
	ABS	11.95-06.03	42/47/66		LLE	0 204 125 262			
	1.9 SDI		09.00-06.03	47		LLE	0 986 486 109		
		1.9 TDI		10.96-09.00	66		LLE	0 986 486 038	
				09.97-06.03	66		LLE	0 986 486 109	
	1.9 SDI		09.00-06.03	47			0 986 486 542		
		1.9 TDI		10.96-09.00	66			0 986 486 537	
	1.4		11.95-06.03	42/44/47/			0 204 031 290 ¹⁰		
	1.6			55/66					
	1.7 SDI								
	1.9 D, SDI, TDI								
	1.4		11.95-06.03	42/44/47/			1 987 477 626	1671	
	1.6			55/66					
	1.7 SDI								
	1.9 D, SDI, TDI								



	1.4	11.95-06.03	42/44/47/	LAB	0 986 594 001 ³	
	1.6		55/66	RAB	0 986 594 000 ³	
	1.7 SDI					
	1.9 D, SDI, TDI					

California T4 [70, 7D]





























































	1.8	12.90-07.92	49	MVB	1 987 476 411	330
	1.9D	09.90-12.95	45	MVB	1 987 476 411	330
		01.96-04.97	45	MVB	1 987 476 698	375
	1.9D Turbo	10.92-12.95	50	MVB	1 987 476 411	330
		01.96-04.98	50	MVB	1 987 476 698	375
		05.98-06.03	50	MVB	1 987 476 698	375
	2.0	09.90-12.95	62	MVB	1 987 476 411	330
		01.96-04.98	62	MVB	1 987 476 698	375
		05.98-06.03	62	MVB	1 987 476 698	375
	2.4D	09.90-12.95	57	MVB	1 987 476 411	330
		01.96-04.98	57	MVB	1 987 476 698	375
		05.97-04.98	55	MVB	1 987 476 698	375
		05.98-05.98	57	MVB	1 987 476 698	375
		05.98-06.03	55	MVB	1 987 476 698	375
	2.4D Syncro	11.92-12.95	57	MVB	1 987 476 411	330
		01.96-04.98	57	MVB	1 987 476 698	375
		05.98-09.98	57	MVB	1 987 476 698	375
	2.5	11.90-12.93	81	MVB	1 987 476 411	330
		07.94-12.95	81	MVB	1 987 476 411	330
		09.95-12.95	81	MVB	1 987 476 411	330
		01.96-10.96	81	MVB	1 987 476 698	375
		08.96-04.98	81	MVB	1 987 476 698	375
			85	MVB	1 987 476 698	375
		05.98-06.03	81	MVB	1 987 476 698	375
			85	MVB	1 987 476 698	375
	2.5 Syncro	11.92-12.95	81	MVB	1 987 476 411	330
		01.96-10.96	81	MVB	1 987 476 698	375
		08.96-04.98	85	MVB	1 987 476 698	375
		06.97-04.98	81	MVB	1 987 476 698	375
		05.98-11.01	81	MVB	1 987 476 698	375
		05.98-06.03	85	MVB	1 987 476 698	375
	2.5 TDI	01.95-12.95	75	MVB	1 987 476 411	330
		01.96-04.98	75	MVB	1 987 476 698	375
		05.98-06.03	65	MVB	1 987 476 698	375
			75	MVB	1 987 476 698	375
			111	MVB	1 987 476 698	375
	2.5 TDI Syncro	03.98-04.98	75	MVB	1 987 476 698	375
		05.98-06.03	75	MVB	1 987 476 698	375
	2.8	05.96-04.98	103	MVB	1 987 476 698	375
		05.98-05.00	103	MVB	1 987 476 698	375
		05.00-06.03	150	MVB	1 987 476 698	375



◀ VW California T4 [70, 7D]										
	1.8	09.90-04.98	45/49/50/	PR-Nr. 1LP	281	0986 473 177		53,93		
	1.9 D		55/57/62/			0986 474 177		53,93		
	1.9 D Turbo		81/85							
	2.0	09.90-06.03	45/49/50/	PR-Nr. 1LA	266	0986 473 703		54		
	2.4 D		55/57/62/			0986 474 703		54		
	2.4 D Syncro		81/85	PR-Nr. 1LB	1KX	0986 473 184		57		
	2.5					0986 474 184		57		
	2.5 Syncro				326	0986 473 178		56,96	1987 470 005 ⁷	
						0986 474 178		56,96	1987 470 005 ⁷	
				PR-Nr. 1LE	284	LUC	0986 473 806		54	
							0986 473 807		54	
				PR-Nr. 1LU	284	ATE	0986 473 361		56,93	1987 470 005 ⁷
							0986 473 361		56,93	1987 470 506 ⁸
							0986 474 361		56,93	1987 470 506 ⁸
	2.5 Syncro	08.96-04.98	85	PR-Nr. 1LP	281	0986 473 177		53,93		
						0986 474 177		53,93		
		08.96-06.03	85	PR-Nr. 1LA	266	0986 473 703		54		
						0986 474 703		54		
				PR-Nr. 1LB	1KX	0986 473 184		57		
						0986 474 184		57		
					326	0986 473 178		56,96	1987 470 005 ⁷	
						0986 474 178		56,96	1987 470 005 ⁷	
				PR-Nr. 1LE	284	LUC	0986 473 806		54	
							0986 473 807		54	
				PR-Nr. 1LU	284	ATE	0986 473 361		56,93	1987 470 005 ⁷
							0986 473 361		56,93	1987 470 506 ⁸
							0986 474 361		56,93	1987 470 506 ⁸
		12.99-06.03	85	PR-Nr. 1LU	284	ATE	0986 474 361		56,93	1987 470 005 ⁷
	2.5 TDI	01.95-04.98	75	PR-Nr. 1LP	281	0986 473 177		53,93		
						0986 474 177		53,93		
		01.95-06.03	75	PR-Nr. 1LA	266	0986 473 703		54		
						0986 474 703		54		
				PR-Nr. 1LB	1KX	0986 473 184		57		
						0986 474 184		57		
					326	0986 473 178		56,96	1987 470 005 ⁷	
						0986 474 178		56,96	1987 470 005 ⁷	
				PR-Nr. 1LE	284	LUC	0986 473 806		54	
							0986 473 807		54	
				PR-Nr. 1LU	284	ATE	0986 473 361		56,93	1987 470 005 ⁷
							0986 473 361		56,93	1987 470 506 ⁸
							0986 474 361		56,93	1987 470 506 ⁸
		05.98-06.03	65	PR-Nr. 1LA	266	0986 473 703		54		
						0986 474 703		54		
				PR-Nr. 1LB	1KX	0986 473 184		57		
						0986 474 184		57		
					326	0986 473 178		56,96	1987 470 005 ⁷	
						0986 474 178		56,96	1987 470 005 ⁷	
				PR-Nr. 1LE	284	LUC	0986 473 806		54	
							0986 473 807		54	
				PR-Nr. 1LU	284	ATE	0986 473 361		56,93	1987 470 005 ⁷
							0986 473 361		56,93	1987 470 506 ⁸
							0986 474 361		56,93	1987 470 506 ⁸















	S																							
2.5 TDI	05.98-06.03	111	PR-Nr. 1LA	266		0 986 473 703	 ← 54																	
						0 986 474 703	 → 54																	
				PR-Nr. 1LB	1KX		0 986 473 184	 ← 57																
							0 986 474 184	 → 57																
							326	0 986 473 178	 ← 56,96	1 987 470 005 ⁷														
								0 986 474 178	 → 56,96	1 987 470 005 ⁷														
				PR-Nr. 1LE	284	LUC	0 986 473 806	 ← 54																
							0 986 473 807	 → 54																
							PR-Nr. 1LU	284	ATE	0 986 473 361	 ← 56,93	1 987 470 005 ⁷												
										0 986 473 361	 ← 56,93	1 987 470 506 ⁸												
							0 986 474 361	 → 56,93	1 987 470 506 ⁸															
2.5 TDI Syncro	03.98-04.98	75/103	PR-Nr. 1LP	281		0 986 473 177	 ← 53,93																	
						0 986 474 177	 → 53,93																	
	03.98-06.03	75/103		PR-Nr. 1LA	266		0 986 473 703	 ← 54																
							0 986 474 703	 → 54																
							PR-Nr. 1LB	1KX		0 986 473 184	 ← 57													
										0 986 474 184	 → 57													
					326		0 986 473 178	 ← 56,96	1 987 470 005 ⁷															
							0 986 474 178	 → 56,96	1 987 470 005 ⁷															
				PR-Nr. 1LE	284	LUC	0 986 473 806	 ← 54																
							0 986 473 807	 → 54																
				PR-Nr. 1LU	284	ATE	0 986 473 361	 ← 56,93	1 987 470 005 ⁷															
							0 986 473 361	 ← 56,93	1 987 470 506 ⁸															
0 986 474 361							 → 56,93	1 987 470 506 ⁸																
2.8	05.96-04.98	75/103	PR-Nr. 1LP	281		0 986 473 177	 ← 53,93																	
						0 986 474 177	 → 53,93																	
	05.96-05.00	75/103		PR-Nr. 1LA	266		0 986 473 703	 ← 54																
							0 986 474 703	 → 54																
							PR-Nr. 1LB	1KX		0 986 473 184	 ← 57													
										0 986 474 184	 → 57													
					326		0 986 473 178	 ← 56,96	1 987 470 005 ⁷															
							0 986 474 178	 → 56,96	1 987 470 005 ⁷															
				PR-Nr. 1LE	284	LUC	0 986 473 806	 ← 54																
							0 986 473 807	 → 54																
				PR-Nr. 1LU	284	ATE	0 986 473 361	 ← 56,93	1 987 470 005 ⁷															
							0 986 473 361	 ← 56,93	1 987 470 506 ⁸															
0 986 474 361							 → 56,93	1 987 470 506 ⁸																
05.00-06.03	150		PR-Nr. 1LA	266		0 986 473 703	 ← 54																	
						0 986 474 703	 → 54																	
						PR-Nr. 1LB	1KX		0 986 473 184	 ← 57														
									0 986 474 184	 → 57														
										326		0 986 473 178	 ← 56,96	1 987 470 005 ⁷										
												0 986 474 178	 → 56,96	1 987 470 005 ⁷										
									PR-Nr. 1LE	284	LUC	0 986 473 806	 ← 54											
												0 986 473 807	 → 54											
									PR-Nr. 1LU	284	ATE	0 986 473 361	 ← 56,93	1 987 470 005 ⁷										
												0 986 473 361	 ← 56,93	1 987 470 506 ⁸										
												0 986 474 361	 → 56,93	1 987 470 506 ⁸										
																								
										1.8	09.90-06.03	45/49/50/		SSZ	1 987 476 220	160								
																		1.9 D, D Turbo	55/57/62/					
																		2.4 D, D Syncro	85/111					
									2.5, Syncro, TDI	03.98-06.03	75			SSZ	1 987 476 220	160								
																		2.5 TDI Syncro	04.01-06.03	75				1 987 476 220 ¹
															1 987 476 230 ²	160								
									2.8	05.96-06.03	103/150			SSZ	1 987 476 220	160								





◀ VW California T4 [70, 7D]

	1.8	09.90-06.03	45/49/50/		0 986 475 935	↔ 20,64
	1.9 D, D Turbo		55/57/62/			
	2.0		65/75/81/			
	2.4 D, D Syncro		85/103/			
	2.5, Syncro, TDI, TDI Syncro		111/150			
2.8						
<hr/>						
	1.8	ABO, 12.90-07.92	49		F 026 003 563	22
		OFD				
		ABS, 12.90-07.92	49		0 986 480 834	22,19
1.9 D		ABO, 06.95-06.03	45/50/62	Fg.Nr. 70..S..127 806→	0 986 480 930	23,8
	1.9 D Turbo	ABO, 09.90-05.95	45/50/62	Fg.Nr. →70..S..127 805	F 026 003 563	22
		OFD				
		ABS, 09.90-05.95	45/50/62	Fg.Nr. →70..S..127 805	0 986 480 834	22,19
		ABS, 06.95-06.03	45/50/62	Fg.Nr. 70..S..127 806→	0 986 480 933	23,8
		OFD				
2.0		ABO, 06.95-06.03	45/50/62	Fg.Nr. 70..S..127 806→	0 986 480 930	23,8
		ABO, 09.90-05.95	45/50/62	Fg.Nr. →70..S..127 805	F 026 003 563	22
		OFD				
		ABS, 09.90-05.95	45/50/62	Fg.Nr. →70..S..127 805	0 986 480 834	22,19
		ABS, 06.95-06.03	45/50/62	Fg.Nr. 70..S..127 806→	0 986 480 933	23,8
		OFD				
2.4 D		ABO, 05.97-06.03	55		0 986 480 930	23,8
		ABS, 05.97-06.03	55		0 986 480 933	23,8
		OFD				
2.4 D		ABO, 06.95-09.98	57	Fg.Nr. 70..S..127 806→	0 986 480 930	23,8
2.4 D Syncro		ABO, 09.90-05.95	57	Fg.Nr. →70..S..127 805	F 026 003 563	22
		OFD				
		ABS, 09.90-05.95	57	Fg.Nr. →70..S..127 805	0 986 480 834	22,19
		ABS, 06.95-09.98	57	Fg.Nr. 70..S..127 806→	0 986 480 933	23,8
		OFD				
2.5		ABO, 06.95-10.96	81	Fg.Nr. 70..S..127 806→	0 986 480 930	23,8
		09.95-12.95	81		0 986 480 930	23,8
		08.96-06.03	81		0 986 480 930	23,8
		ABS, 06.95-10.96	81	Fg.Nr. 70..S..127 806→	0 986 480 933	23,8
		OFD, 09.95-12.95	81		0 986 480 933	23,8
		08.96-06.03	81		0 986 480 933	23,8
2.5		ABO, 08.96-06.03	85		0 986 480 930	23,8
	2.5 Syncro	ABO, 11.90-12.93	81		F 026 003 563	22
		OFD, 01.94-05.95	81	Fg.Nr. →70..S..127 805	F 026 003 563	22
		ABS, 11.90-12.93	81		0 986 480 834	22,19
		01.94-05.95	81	Fg.Nr. →70..S..127 805	0 986 480 834	22,19
		ABS, 08.96-06.03	85		0 986 480 933	23,8
		OFD				
2.5 Syncro		ABO, 06.95-10.96	81	Fg.Nr. 70..S..127 806→	0 986 480 930	23,8
		06.97-11.01	81		0 986 480 930	23,8
		ABS, 06.95-10.96	81	Fg.Nr. 70..S..127 806→	0 986 480 933	23,8
		OFD, 06.97-11.01	81		0 986 480 933	23,8
2.5 TDI		ABO, 06.95-06.03	75	Fg.Nr. 70..S..127 806→	0 986 480 930	23,8
		05.98-06.03	65		0 986 480 930	23,8
			111		0 986 480 930	23,8
		05.99-06.03	75		0 986 480 930	23,8
		ABO, 01.95-05.95	75	Fg.Nr. →70..S..127 805	F 026 003 563	22
		OFD				
		ABS, 01.95-05.95	75	Fg.Nr. →70..S..127 805	0 986 480 834	22,19
		ABS, 06.95-06.03	75	Fg.Nr. 70..S..127 806→	0 986 480 933	23,8
		OFD, 05.98-06.03	65		0 986 480 933	23,8
			111		0 986 480 933	23,8
		05.99-06.03	75		0 986 480 933	23,8

		S							
	2.5 TDI Syncro	ABO 03.98-06.03	75				0 986 480 930	23,8	
		ABS 04.01-06.03	75				0 986 480 933	23,8	
		ABS, 03.98-06.03	75				0 986 480 933	23,8	
		OFD							
	2.8	ABO 05.96-06.03	103/150				0 986 480 930	23,8	
		ABS, 05.96-06.03	103/150				0 986 480 933	23,8	
		OFD							
	1.8	OFD 12.90-07.92	49				0 986 485 112		
	1.9 D, D Turbo	OFD 09.90-05.95	45/50/57/	Fg.Nr. →70..S..127 805			0 986 485 112		
	2.0		62						
	2.4 D, D Syncro								
	2.5	OFD 11.90-12.93	81				0 986 485 112		
	2.5 Syncro	01.94-05.95	81	Fg.Nr. →70..S..127 805			0 986 485 112		
	2.5 TDI	OFD 01.95-05.95	75	Fg.Nr. →70..S..127 805			0 986 485 112		
	1.8	09.90-06.03	45/49/50/		TW		0 986 486 037		
	1.9 D, D Turbo		55/57/62/				0 986 486 048		
	2.0		65/75/81/						
	2.4 D, D Syncro		85/111						
	2.5, Syncro, TDI								
	2.5 TDI Syncro	03.98-06.03	75		TW		0 986 486 037		
							0 986 486 048		
		04.01-06.03	75				0 986 486 048		
	2.8	05.96-06.03	103/150		TW		0 986 486 037		
							0 986 486 048		
	1.8	09.90-04.97	45/49				0 986 486 537		
	1.9 D								
	1.9 D Turbo	09.90-04.97	50/62				0 986 486 537		
	2.0	05.97-06.03	50/62				0 986 486 538		
	2.4 D	05.97-06.03	55				0 986 486 538		
	2.4 D, D Syncro	09.90-04.97	57/81/85				0 986 486 537		
	2.5, Syncro	05.97-06.03	57/81/85				0 986 486 538		
	2.5 TDI	05.98-06.03	65/150				0 986 486 538		
	2.8								
	1.8	09.90-06.03	45/49/50/				0 204 031 292 ¹⁰		
	1.9 D, D Turbo		55/57/62/						
	2.0		65/75/81/						
	2.4 D, D Syncro		85/103/						
	2.5, Syncro, TDI, TDI Syncro		111/150						
	2.8								
	1.8	12.90-07.92	49				1 987 477 171	↔ 854	
	1.9 D, D Turbo	09.90-02.97	45/50/62	Fg.Nr. →70..V..120 000	SBR		1 987 477 706	↔ 938	
	2.0	09.90-06.03	45/50/62		TBR		1 987 477 171	↔ 854	
		03.97-06.03	45/50/62	Fg.Nr. 70..V..120 001→	SBR		1 987 477 707	↔ 948	
	2.4 D	09.90-02.97	57	Fg.Nr. →70..V..120 000	SBR		1 987 477 706	↔ 938	
		09.90-05.98	57		TBR		1 987 477 171	↔ 854	
		03.97-05.98	57	Fg.Nr. 70..V..120 001→	SBR		1 987 477 707	↔ 948	
		05.97-06.03	55				1 987 477 707	↔ 948	
					TBR		1 987 477 171	↔ 854	
	2.4 D Syncro	11.92-04.97	57		SBR		1 987 477 706	↔ 938	
		11.92-09.98	57		TBR		1 987 477 171	↔ 854	
		05.97-09.98	57		SBR		1 987 477 707	↔ 948	













◀ VW California T4 [70, 7D]

2.5	11.90-12.93	81			1987 477 171	↔ 854	
	07.94-10.96	81		SBR	1987 477 706	↔ 938	
	07.94-06.03	81		TBR	1987 477 171	↔ 854	
	09.95-12.95	81			1987 477 171	↔ 854	
	08.96-02.97	81	Fg.Nr. →70..V..120 000	SBR	1987 477 706	↔ 938	
		85	Fg.Nr. →70..V..120 000	SBR	1987 477 706	↔ 938	
	08.96-06.03	85		TBR	1987 477 171	↔ 854	
	03.97-06.03	81	Fg.Nr. 70..V..120 001→	SBR	1987 477 707	↔ 948	
		85	Fg.Nr. 70..V..120 001→	SBR	1987 477 707	↔ 948	
	05.99-06.03	85		SBR	1987 477 707	↔ 948	
2.5 Syncro	11.92-04.97	81/85		SBR	1987 477 706	↔ 938	
	11.92-06.03	81/85		TBR	1987 477 171	↔ 854	
	05.97-06.03	81/85		SBR	1987 477 707	↔ 948	
2.5 TDI	01.95-02.97	75	Fg.Nr. →70..V..120 000	SBR	1987 477 706	↔ 938	
	01.95-06.03	75		TBR	1987 477 171	↔ 854	
	03.97-06.03	75	Fg.Nr. 70..V..120 001→	SBR	1987 477 707	↔ 948	
	05.98-06.03	65			SBR	1987 477 707	↔ 948
					TBR	1987 477 171	↔ 854
					SBR	1987 477 707	↔ 948
		111			TBR	1987 477 171	↔ 854
	05.99-06.03	75		SBR	1987 477 707	↔ 948	
2.5 TDI Syncro	03.98-06.03	75		SBR	1987 477 707	↔ 948	
				TBR	1987 477 171	↔ 854	
					1987 477 706	↔ 938	
2.8	05.96-02.97	103	Fg.Nr. →70..V..120 000	SBR	1987 477 706	↔ 938	
	05.96-05.00	103		TBR	1987 477 171	↔ 854	
	03.97-05.00	103	Fg.Nr. 70..V..120 001→	SBR	1987 477 707	↔ 948	
	05.00-06.03	150			SBR	1987 477 707	↔ 948
					TBR	1987 477 171	↔ 854

1.8	12.90-07.92	49			0 265 202 454 ²⁰	
	1.9 D, D Turbo	09.90-06.03	45/50/55/57/62/65/75/81/85/111		0 265 202 454 ²⁰	
	2.0	01.96-06.03	45/50/55/57/62/65/75/81/85/111		0 265 220 434 ¹⁴	
	2.4 D, D Syncro					
	2.5, Syncro, TDI, TDI Syncro					
2.8	05.96-05.00	103			0 265 202 454 ²⁰	
	10.97-05.00	103	Fg.Nr. 70..W..062 420→		0 265 220 434 ¹⁴	
	05.00-06.03	150			0 265 202 454 ²⁰	
					0 265 220 434 ¹⁴	

1.8	09.90-12.95	45/49/50/62			0 265 100 072 ¹⁶		
	1.9 D, D Turbo	09.90-06.03	45/49/50/62	1KX,326	0 265 109 612 ²⁰		
2.0				281,284,GRG	0 265 109 602 ²⁰		
	2.4 D	05.97-06.03	55	1KX,326	0 265 109 612 ²⁰		
				281,284,GRG	0 265 109 602 ²⁰		
2.4 D	09.90-12.95	57/81			0 265 100 072 ¹⁶		
2.4 D Syncro	09.90-06.03	57/81		1KX,326	0 265 109 612 ²⁰		
2.5				281,284,GRG	0 265 109 602 ²⁰		
2.5	08.96-06.03	85		1KX,326	0 265 109 612 ²⁰		
				281,284,GRG	0 265 109 602 ²⁰		
2.5 Syncro	11.92-12.95	81			0 265 100 072 ¹⁶		
	11.92-10.96	81		1KX,326	0 265 109 612 ²⁰		
					281,284,GRG	0 265 109 602 ²⁰	
	06.97-11.01	81		1KX,326	0 265 109 612 ²⁰		
				281,284,GRG	0 265 109 602 ²⁰		
2.5 Syncro	08.96-06.03	65/85		1KX,326	0 265 109 612 ²⁰		
2.5 TDI				281,284,GRG	0 265 109 602 ²⁰		
2.5 TDI	01.95-12.95	75			0 265 100 072 ¹⁶		
	01.95-06.03	75		1KX,326	0 265 109 612 ²⁰		
					281,284,GRG	0 265 109 602 ²⁰	
					05.98-06.03	111	1KX,326
				281,284,GRG	0 265 109 602 ²⁰		

		S										
2.5 TDI Syncro		03.98-06.03	75				1KX,326	0 265 109 612 ²⁰				
							281,284,GRG	0 265 109 602 ²⁰				
							04.01-05.02	75	Fg.Nr. →70..3..019 101	GRG	0 265 109 602 ²⁰	
							06.02-06.03	75	Fg.Nr. 70..3..019 102→		0 265 109 612 ²⁰	
2.8		05.96-06.03	103/150				1KX,326	0 265 109 612 ²⁰				
							281,284,GRG	0 265 109 602 ²⁰				
 1.8		12.90-07.92	49					0 265 006 407 ³				
							LAB,MVB	0 265 006 508 ⁴				
							MVB,RAB	0 265 006 510 ⁴				
							MVB	0 986 594 013 ⁴				
1.9 D		09.90-12.95	45/50/62	Fg.Nr. →70..T..199 000		MVB	0 986 594 013 ⁴					
1.9 D Turbo		09.90-06.03	45/50/62				0 265 006 407 ³					
2.0						LAB,MVB	0 265 006 508 ⁴					
							MVB,RAB	0 265 006 510 ⁴				
		01.96-06.03	45/50/62	Fg.Nr. 70..T..200 001→		LAB,MVB	0 265 006 408 ⁴					
						MVB,RAB	0 265 006 409 ⁴					
2.4 D		05.97-06.03	55					0 265 006 407 ³				
							LAB,MVB	0 265 006 508 ⁴				
							LAB,MVB	0 265 006 408 ⁴				
							MVB,RAB	0 265 006 510 ⁴				
						MVB,RAB	0 265 006 409 ⁴					
2.4 D		09.90-12.95	57	Fg.Nr. →70..T..199 000		MVB	0 986 594 013 ⁴					
2.4 D Syncro		09.90-09.98	57				0 265 006 407 ³					
						LAB,MVB	0 265 006 508 ⁴					
							MVB,RAB	0 265 006 510 ⁴				
		01.96-09.98	57	Fg.Nr. 70..T..200 001→		LAB,MVB	0 265 006 408 ⁴					
						MVB,RAB	0 265 006 409 ⁴					
2.5		11.90-12.93	81					0 265 006 407 ³				
							LAB,MVB	0 265 006 508 ⁴				
							MVB,RAB	0 265 006 510 ⁴				
							MVB	0 986 594 013 ⁴				
							07.94-12.95	81	Fg.Nr. →70..T..199 000	MVB	0 986 594 013 ⁴	
							07.94-10.96	81			0 265 006 407 ³	
							07.94-06.03	81		LAB,MVB	0 265 006 508 ⁴	
										MVB,RAB	0 265 006 510 ⁴	
							09.95-12.95	81		MVB,RAB	0 265 006 510 ⁴	
										MVB	0 986 594 013 ⁴	
							01.96-10.96	81	Fg.Nr. 70..T..200 001→	LAB,MVB	0 265 006 408 ⁴	
										MVB,RAB	0 265 006 409 ⁴	
							08.96-06.03	81			0 265 006 407 ³	
										LAB,MVB	0 265 006 408 ⁴	
										MVB,RAB	0 265 006 409 ⁴	
											0 265 006 407 ³	
			LAB,MVB	0 265 006 508 ⁴								
			LAB,MVB	0 265 006 408 ⁴								
			MVB,RAB	0 265 006 510 ⁴								
			MVB,RAB	0 265 006 409 ⁴								
2.5 Syncro		11.92-12.93	81				LAB,MVB	0 265 006 508 ⁴				
							MVB,RAB	0 265 006 510 ⁴				
							MVB	0 986 594 013 ⁴				
											0 265 006 407 ³	
							11.92-10.96	81			0 265 006 407 ³	
							01.94-12.95	81	Fg.Nr. →70..T..199 000	MVB	0 986 594 013 ⁴	
							01.94-10.96	81		LAB,MVB	0 265 006 508 ⁴	
										MVB,RAB	0 265 006 510 ⁴	
							01.96-10.96	81	Fg.Nr. 70..T..200 001→	LAB,MVB	0 265 006 408 ⁴	
										MVB,RAB	0 265 006 409 ⁴	
06.97-11.01	81			0 265 006 407 ³								
			LAB,MVB	0 265 006 508 ⁴								
			LAB,MVB	0 265 006 408 ⁴								
			MVB,RAB	0 265 006 510 ⁴								
			MVB,RAB	0 265 006 409 ⁴								



		S							
	◀ VW California T4 [70, 7D]								
2.5 Syncro		08.96-06.03	65/85				0 265 006 407³		
2.5 TDI						LAB,MVB	0 265 006 508⁴		
						LAB, MVB	0 265 006 408⁴		
						MVB,RAB	0 265 006 510⁴		
						MVB ,RAB	0 265 006 409⁴		
2.5 TDI		01.95-12.95	75	Fg.Nr. →70..T..199 000		MVB	0 986 594 013⁴		
		01.95-06.03	75				0 265 006 407³		
						LAB,MVB	0 265 006 508⁴		
						MVB,RAB	0 265 006 510⁴		
		01.96-06.03	75	Fg.Nr. 70..T..200 001→		LAB, MVB	0 265 006 408⁴		
						MVB ,RAB	0 265 006 409⁴		
		05.99-06.03	75			LAB, MVB	0 265 006 408⁴		
						MVB ,RAB	0 265 006 409⁴		
2.5 TDI		03.98-06.03	75/103/				0 265 006 407³		
2.5 TDI Syncro			111/150			LAB,MVB	0 265 006 508⁴		
						LAB, MVB	0 265 006 408⁴		
						MVB,RAB	0 265 006 510⁴		
						MVB ,RAB	0 265 006 409⁴		
2.8		05.96-06.03	75/103/				0 265 006 407³		
			111/150			LAB,MVB	0 265 006 508⁴		
						LAB, MVB	0 265 006 408⁴		
						MVB,RAB	0 265 006 510⁴		
						MVB ,RAB	0 265 006 409⁴		

	1.8	09.90-06.03	45/49/50/				0 265 005 214		
	1.9 D, D Turbo		55/57/62/						
	2.0		65/75/81/						
	2.4 D, D Syncro		85/103/						
	2.5, Syncro, TDI, TDI Syncro		111/150						
	2.8								

California T5 [7E]

	2.0 TDI	09.09→	62/75/103/132		L55		1 987 481 182	558	
	2.0 TDI	09.09→	62/75/103				0 986 473 193	← 60	
							0 986 474 193	→ 60	
	2.0 TDI	09.09→	62/75/103/132				1 987 476 309¹	250	
	2.0 TDI	09.09→	62/75/103/132						1 987 470 040⁷
	2.0 TDI	09.09→	62/75/103/132				1 987 477 260	↔ 1297	



California T5 [7H]



	1.9 TDI	02.03-11.09	62/63/75/		L55	1 987 481 182	558
	2.0		77/85/96/				
	2.5 TDI, TDI 4 Motion		120/128/				
	3.2, 4 Motion		170/173				

	1.9 TDI	02.03-11.09	62/63/75/		308	0 986 473 193	← 60
	2.0		77/85/96/			0 986 474 193	→ 60
	2.5 TDI, TDI 4 Motion		120/128/		333	0 986 473 181	← 59,96
	3.2, 4 Motion		170/173			0 986 474 181	→ 59,96



	1.9 TDI	02.03-11.09	62/63/75/			1 987 476 309 ¹	250
	2.0		77/85/96/			1 987 476 310 ²	190
	2.5 TDI, TDI 4 Motion		120/128/	PR-Nr. OWR	LAB	1 987 476 313 ²	243
	3.2, 4 Motion		170/173		RAB	1 987 476 320 ²	243

	1.9 TDI	02.03-11.09	62/63/75/		294		1 987 470 040 ⁷
	2.0		77/85/96/		322	0 986 473 188	← 44 1 987 470 506 ⁸
	2.5 TDI, TDI 4 Motion		120/128/			0 986 474 188	→ 44 1 987 470 506 ⁸
	3.2, 4 Motion		170/173				



	1.9 TDI	04.03-11.09	62/63/75/	PR-Nr. 1AT		0 986 480 992	27
	2.0		77/85				
	2.5 TDI	02.03-11.09	96		LLE	0 986 480 992	27
			128		LLE	0 986 480 992	27
		11.03-11.09	120	PR-Nr. 1AT		0 986 480 992	27
			01.06-11.09	96	PR-Nr. 1AT		0 986 480 992
	128	PR-Nr. 1AT			0 986 480 992	27	
					0 986 480 992	27	
	2.5 TDI 4 Motion	07.04-11.09	96/128		LLE	0 986 480 992	27
		01.06-11.09	96/128			0 986 480 992	27
	3.2	02.03-06.04	170	PR-Nr. 1AT		0 986 480 992	27
		05.03-11.09	173	PR-Nr. 1AT		0 986 480 992	27
	3.2 4 Motion	07.04-11.09	173			0 986 480 992	27

	1.9 TDI	02.03-11.09	62/63/75/	PR-Nr. OWN, PR-Nr. OWP,		1 987 477 260	↔ 1297		
	2.0		77/85/96/	PR-Nr. OWQ, PR-Nr. OWL,					
	2.5 TDI		120/128	PR-Nr. OWM	PR-Nr. OWR	1 987 482 014	↔ 1270		
	2.5 TDI 4 Motion	07.04-11.09	96/128			FKR	1 987 482 016	↔ 1650	
						FLR	1 987 482 017	↔ 2015	
	3.2	02.03-06.04	170	PR-Nr. OWN, PR-Nr. OWP,	PR-Nr. OWQ, PR-Nr. OWL,	PR-Nr. OWM	PR-Nr. OWR	1 987 477 260	↔ 1297
		05.03-11.09	173	PR-Nr. OWN, PR-Nr. OWP,	PR-Nr. OWQ, PR-Nr. OWL,	PR-Nr. OWM	PR-Nr. OWR	1 987 477 260	↔ 1297
	3.2 4 Motion	07.04-11.09	173			FKR	1 987 482 016	↔ 1650	
						FLR	1 987 482 017	↔ 2015	





◀ VW California T5 [7H]

	1.9 TDI	02.03-11.09	62/63/75/	LAB	0 986 594 504	
	2.0		77/85/96/		0 986 594 504 ³	
	2.5 TDI, TDI 4 Motion		120/128/		0 986 594 504 ⁴	
	3.2, 4 Motion		170/173	RAB	0 986 594 505	
					0 986 594 505 ³	
					0 986 594 505 ⁴	

Caravelle T4 [70, 7D]



	1.8	12.90-07.92	49	MVB	1 987 476 411	330
	1.9 D	10.90-12.95	45	MVB	1 987 476 411	330
		01.96-04.97	45	MVB	1 987 476 698	375
	1.9 D Turbo	10.92-12.95	50	MVB	1 987 476 411	330
		01.96-04.98	50	MVB	1 987 476 698	375
		05.98-06.03	50	MVB	1 987 476 698	375
	2.0	09.90-12.95	62	MVB	1 987 476 411	330
		01.96-04.98	62	MVB	1 987 476 698	375
		05.98-06.03	62	MVB	1 987 476 698	375
	2.4 D	09.90-12.95	57	MVB	1 987 476 411	330
		01.96-04.98	57	MVB	1 987 476 698	375
		05.97-04.98	55	MVB	1 987 476 698	375
		05.98-05.98	57	MVB	1 987 476 698	375
		05.98-06.03	55	MVB	1 987 476 698	375
	2.4 D Syncro	11.92-12.95	57	MVB	1 987 476 411	330
		01.96-04.98	57	MVB	1 987 476 698	375
		05.98-09.98	57	MVB	1 987 476 698	375
	2.5	11.90-12.93	81	MVB	1 987 476 411	330
		07.94-12.95	81	MVB	1 987 476 411	330
		01.96-04.98	81	MVB	1 987 476 698	375
		08.96-04.98	85	MVB	1 987 476 698	375
		05.98-06.03	81	MVB	1 987 476 698	375
			85	MVB	1 987 476 698	375
	2.5 Syncro	11.92-12.95	81	MVB	1 987 476 411	330
		01.96-10.96	81	MVB	1 987 476 698	375
		08.96-04.98	85	MVB	1 987 476 698	375
		06.97-04.98	81	MVB	1 987 476 698	375
		05.98-11.01	81	MVB	1 987 476 698	375
		05.98-06.03	85	MVB	1 987 476 698	375
	2.5 TDI	01.95-12.95	75	MVB	1 987 476 411	330
		01.96-04.98	75	MVB	1 987 476 698	375
		05.98-06.03	65	MVB	1 987 476 698	375
			75	MVB	1 987 476 698	375
			111	MVB	1 987 476 698	375
		04.01-06.03	75	MVB	1 987 476 698	375
	2.5 TDI Syncro	03.98-04.98	75	MVB	1 987 476 698	375
		05.98-06.03	75	MVB	1 987 476 698	375
		04.01-06.03	75	MVB	1 987 476 698	375
	2.8	01.96-04.98	103	MVB	1 987 476 698	375
		05.98-05.00	103	MVB	1 987 476 698	375
		05.00-06.03	150	MVB	1 987 476 698	375



		S											
	1.8	12.90-07.92	49	PR-Nr. 1LA	266		0 986 473 703		54				
							0 986 474 703		54				
							0 986 473 184		57				
					PR-Nr. 1LB	1KX	326		0 986 474 184		57		
									0 986 473 178		56,96	1 987 470 005 ⁷	
										0 986 474 178		56,96	1 987 470 005 ⁷
					PR-Nr. 1LE	284	LUC		0 986 473 806		54		
									0 986 473 807		54		
					PR-Nr. 1LP	281			0 986 473 177		53,93		
									0 986 474 177		53,93		
					PR-Nr. 1LU	284	ATE		0 986 473 361		56,93	1 987 470 005 ⁷	
									0 986 473 361		56,93	1 987 470 506 ⁸	
0 986 474 361		56,93	1 987 470 005 ⁷										
1.9 D	09.90-04.98	45/50/62	PR-Nr. 1LP	281		0 986 473 177		53,93					
1.9 D Turbo						0 986 474 177		53,93					
2.0	09.90-06.03	45/50/62	PR-Nr. 1LA	266		0 986 473 703		54					
						0 986 474 703		54					
						0 986 473 184		57					
				PR-Nr. 1LB	1KX	326		0 986 474 184		57			
								0 986 473 178		56,96	1 987 470 005 ⁷		
									0 986 474 178		56,96	1 987 470 005 ⁷	
				PR-Nr. 1LE	284	LUC		0 986 473 806		54			
								0 986 473 807		54			
				PR-Nr. 1LU	284	ATE		0 986 473 361		56,93	1 987 470 005 ⁷		
								0 986 473 361		56,93	1 987 470 506 ⁸		
								0 986 474 361		56,93	1 987 470 506 ⁸		
			2.4 D	05.97-04.98	55	PR-Nr. 1LP	281		0 986 473 177		53,93		
0 986 474 177		53,93											
	05.97-06.03	55	PR-Nr. 1LA	266		0 986 473 703		54					
						0 986 474 703		54					
						0 986 473 184		57					
				PR-Nr. 1LB	1KX	326		0 986 474 184		57			
								0 986 473 178		56,96	1 987 470 005 ⁷		
									0 986 474 178		56,96	1 987 470 005 ⁷	
				PR-Nr. 1LE	284	LUC		0 986 473 806		54			
								0 986 473 807		54			
				PR-Nr. 1LU	284	ATE		0 986 473 361		56,93	1 987 470 005 ⁷		
								0 986 473 361		56,93	1 987 470 506 ⁸		
								0 986 474 361		56,93	1 987 470 005 ⁷		
			2.4 D	09.90-04.98	57/81/85	PR-Nr. 1LP	281		0 986 473 177		53,93		
2.4 D Syncro						0 986 474 177		53,93					
2.5	09.90-06.03	57/81/85	PR-Nr. 1LA	266		0 986 473 703		54					
						0 986 474 703		54					
						0 986 473 184		57					
				PR-Nr. 1LB	1KX	326		0 986 474 184		57			
								0 986 473 178		56,96	1 987 470 005 ⁷		
									0 986 474 178		56,96	1 987 470 005 ⁷	
				PR-Nr. 1LE	284	LUC		0 986 473 806		54			
								0 986 473 807		54			
				PR-Nr. 1LU	284	ATE		0 986 473 361		56,93	1 987 470 005 ⁷		
								0 986 473 361		56,93	1 987 470 506 ⁸		
								0 986 474 361		56,93	1 987 470 506 ⁸		



		S								
◀ VW Caravelle T4 [70, 7D]										
2.5 Syncro	08.96-04.98	85	PR-Nr. 1LP	281	0986 473 177		53,93			
					0986 474 177		53,93			
			08.96-06.03	85	PR-Nr. 1LA	266	0986 473 703		54	
					0986 474 703		54			
				PR-Nr. 1LB	1KX	0986 473 184		57		
						0986 474 184		57		
					326	0986 473 178		56,96	1987 470 005 ⁷	
						0986 474 178		56,96	1987 470 005 ⁷	
				PR-Nr. 1LE	284	LUC	0986 473 806		54	
						0986 473 807		54		
				PR-Nr. 1LU	284	ATE	0986 473 361		56,93	1987 470 005 ⁷
						0986 473 361		56,93	1987 470 506 ⁸	
						0986 474 361		56,93	1987 470 506 ⁸	
	2.5 TDI	05.99-12.99	85	PR-Nr. 1LU	284	ATE	0986 474 361		56,93	1987 470 005 ⁷
				01.95-04.98	75	PR-Nr. 1LP	281	0986 473 177		53,93
							0986 474 177		53,93	
01.95-06.03		75	PR-Nr. 1LA			266	0986 473 703		54	
						0986 474 703		54		
				PR-Nr. 1LB	1KX	0986 473 184		57		
						0986 474 184		57		
					326	0986 473 178		56,96	1987 470 005 ⁷	
						0986 474 178		56,96	1987 470 005 ⁷	
				PR-Nr. 1LE	284	LUC	0986 473 806		54	
						0986 473 807		54		
				PR-Nr. 1LU	284	ATE	0986 473 361		56,93	1987 470 005 ⁷
						0986 473 361		56,93	1987 470 506 ⁸	
						0986 474 361		56,93	1987 470 506 ⁸	
2.5 TDI Syncro		03.98-04.98	75/103	PR-Nr. 1LP	281	0986 473 177		53,93		
					0986 474 177		53,93			
	03.98-06.03			75/103	PR-Nr. 1LA	266	0986 473 703		54	
					0986 474 703		54			
					PR-Nr. 1LB	1KX	0986 473 184		57	
						0986 474 184		57		
					326	0986 473 178		56,96	1987 470 005 ⁷	
						0986 474 178		56,96	1987 470 005 ⁷	
				PR-Nr. 1LE	284	LUC	0986 473 806		54	
						0986 473 807		54		
				PR-Nr. 1LU	284	ATE	0986 473 361		56,93	1987 470 005 ⁷
						0986 473 361		56,93	1987 470 506 ⁸	
						0986 474 361		56,93	1987 470 506 ⁸	
				111	PR-Nr. 1LA	266	0986 473 703		54	
						0986 474 703		54		
			PR-Nr. 1LB	1KX	0986 473 184		57			
					0986 474 184		57			
				326	0986 473 178		56,96	1987 470 005 ⁷		
					0986 474 178		56,96	1987 470 005 ⁷		
			PR-Nr. 1LE	284	LUC	0986 473 806		54		
					0986 473 807		54			
			PR-Nr. 1LU	284	ATE	0986 473 361		56,93	1987 470 005 ⁷	
					0986 473 361		56,93	1987 470 506 ⁸		
					0986 474 361		56,93	1987 470 506 ⁸		



		S											
2.8	01.96-04.98	75/103	PR-Nr. 1LP	281	0 986 473 177		← 53,93						
					0 986 474 177		→ 53,93						
					01.96-05.00	75/103	PR-Nr. 1LA	266	0 986 473 703		← 54		
									0 986 474 703		→ 54		
					PR-Nr. 1LB	1KX	326	0 986 473 184		← 57			
								0 986 474 184		→ 57			
	0 986 473 178		← 56,96	1 987 470 005 ⁷									
	0 986 474 178		→ 56,96	1 987 470 005 ⁷									
	PR-Nr. 1LE	284	LUC	0 986 473 806		← 54							
				0 986 473 807		→ 54							
	PR-Nr. 1LU	284	ATE	0 986 473 361		← 56,93	1 987 470 005 ⁷						
				0 986 473 361		← 56,93	1 987 470 506 ⁸						
				0 986 474 361		→ 56,93	1 987 470 506 ⁸						
	05.00-06.03	150	PR-Nr. 1LA	266	0 986 473 703		← 54						
					0 986 474 703		→ 54						
					PR-Nr. 1LB	1KX	0 986 473 184		← 57				
							0 986 474 184		→ 57				
					326	0 986 473 178		← 56,96	1 987 470 005 ⁷				
0 986 474 178							→ 56,96	1 987 470 005 ⁷					
PR-Nr. 1LE		284	LUC	0 986 473 806		← 54							
				0 986 473 807		→ 54							
PR-Nr. 1LU		284	ATE	0 986 473 361		← 56,93	1 987 470 005 ⁷						
				0 986 473 361		← 56,93	1 987 470 506 ⁸						
				0 986 474 361		→ 56,93	1 987 470 506 ⁸						
		09.90-06.03	45/49/50/ 55/57/62/ 65/75/81/ 85/111		SSZ	1 987 476 220		160					
	03.98-06.03					75	SSZ	1 987 476 220		160			
								1 987 476 220 ¹		160			
								1 987 476 230 ²		160			
	04.01-06.03					75	SSZ	1 987 476 220		160			
								1 987 476 220 ¹		160			
		1 987 476 230 ²		160									
	2.8	01.96-06.03	103/150		SSZ	1 987 476 220		160					
		09.90-06.03	45/49/50/ 55/57/62/ 65/75/81/ 85/103/ 111/150			0 986 475 935		↔ 20,64					
						1.8							
						1.9 D, D Turbo							
						2.0							
2.4 D, D Syncro													
2.5, Syncro, TDI, TDI Syncro													
2.8													
	12.90-07.92	49			F 026 003 563		22						
					1.8								
					OFD								
					ABS								
					06.95-06.03	45/50/62	Fg.Nr. 70..S..127 806→	0 986 480 930		23,8			
					1.9 D								
	1.9 D Turbo	10.90-05.95	45/50/62	Fg.Nr. →70..S..127 805		F 026 003 563		22					
						OFD							
	10.90-05.95	45/50/62	Fg.Nr. →70..S..127 805			0 986 480 834		22,19					
						0 986 480 834		22,19					
						06.95-06.03	45/50/62	Fg.Nr. 70..S..127 806→	0 986 480 933		23,8		
						OFD							
06.95-06.03	45/50/62	Fg.Nr. 70..S..127 806→			0 986 480 930		23,8						
					0 986 480 930		23,8						
					09.90-05.95	45/50/62	Fg.Nr. →70..S..127 805	F 026 003 563		22			
					2.0								
					OFD								
					09.90-05.95	45/50/62	Fg.Nr. →70..S..127 805	0 986 480 834		22,19			
06.95-06.03	45/50/62	Fg.Nr. 70..S..127 806→	0 986 480 933		23,8								
OFD													















 ◀ VW Caravelle T4 [70, 7D]

2.4 D	ABO	05.97-06.03	55		0 986 480 930	23,8
	ABS,	05.97-06.03	55		0 986 480 933	23,8
	OFD					
2.4 D	ABO	06.95-09.98	57	Fg.Nr. 70..S..127 806→	0 986 480 930	23,8
2.4 D Syncro	ABO,	09.90-05.95	57	Fg.Nr. →70..S..127 805	F 026 003 563	22
	OFD					
	ABS	09.90-05.95	57	Fg.Nr. →70..S..127 805	0 986 480 834	22,19
	ABS,	06.95-09.98	57	Fg.Nr. 70..S..127 806→	0 986 480 933	23,8
	OFD					
2.5	ABO	06.95-10.96	81	Fg.Nr. 70..S..127 806→	0 986 480 930	23,8
		09.95-12.95	81		0 986 480 930	23,8
		08.96-06.03	81		0 986 480 930	23,8
	ABS,	06.95-10.96	81	Fg.Nr. 70..S..127 806→	0 986 480 933	23,8
	OFD	09.95-12.95	81		0 986 480 933	23,8
		08.96-06.03	81		0 986 480 933	23,8
2.5	ABO	08.96-06.03	85		0 986 480 930	23,8
2.5 Syncro	ABO,	11.90-12.93	81		F 026 003 563	22
	OFD	01.94-05.95	81	Fg.Nr. →70..S..127 805	F 026 003 563	22
	ABS	11.90-12.93	81		0 986 480 834	22,19
		01.94-05.95	81	Fg.Nr. →70..S..127 805	0 986 480 834	22,19
	ABS,	08.96-06.03	85		0 986 480 933	23,8
	OFD					
2.5 Syncro	ABO	06.95-10.96	81	Fg.Nr. 70..S..127 806→	0 986 480 930	23,8
		06.97-11.01	81		0 986 480 930	23,8
	ABS,	06.95-10.96	81	Fg.Nr. 70..S..127 806→	0 986 480 933	23,8
	OFD	06.97-11.01	81		0 986 480 933	23,8
2.5 TDI	ABO	06.95-06.03	75	Fg.Nr. 70..S..127 806→	0 986 480 930	23,8
		05.98-06.03	65		0 986 480 930	23,8
			111		0 986 480 930	23,8
		05.99-06.03	75		0 986 480 930	23,8
	ABO,	01.95-05.95	75	Fg.Nr. →70..S..127 805	F 026 003 563	22
	OFD					
	ABS	01.95-05.95	75	Fg.Nr. →70..S..127 805	0 986 480 834	22,19
	ABS,	06.95-06.03	75	Fg.Nr. 70..S..127 806→	0 986 480 933	23,8
	OFD	05.98-06.03	65		0 986 480 933	23,8
			111		0 986 480 933	23,8
	05.99-06.03	75		0 986 480 933	23,8	
2.5 TDI Syncro	ABO	03.98-06.03	75		0 986 480 930	23,8
	ABS	04.01-06.03	75		0 986 480 933	23,8
	ABS,	03.98-06.03	75		0 986 480 933	23,8
	OFD					
2.8	ABO	01.96-06.03	103/150		0 986 480 930	23,8
	ABS,	01.96-06.03	103/150		0 986 480 933	23,8
	OFD					

	1.8	OFD	12.90-07.92	49		0 986 485 112
	1.9 D, D Turbo	OFD	09.90-05.95	45/50/57/	Fg.Nr. →70..S..127 805	0 986 485 112
	2.0			62		
	2.4 D, D Syncro					
	2.5	OFD	11.90-12.93	81		0 986 485 112
	2.5 Syncro		01.94-05.95	81	Fg.Nr. →70..S..127 805	0 986 485 112
	2.5 TDI	OFD	01.95-05.95	75	Fg.Nr. →70..S..127 805	0 986 485 112





	1.8		09.90-06.03	45/49/50/	TW	0 986 486 037
	1.9 D, D Turbo			55/57/62/		0 986 486 048
	2.0			65/75/81/		
	2.4 D, D Syncro			85/111		
	2.5, Syncro, TDI					









		S							
2.5 TDI Syncro		03.98-06.03	75			TW	0 986 486 037		
		04.01-06.03	75				0 986 486 048		
2.8		01.96-06.03	103/150			TW	0 986 486 037		
							0 986 486 048		
 1.8		10.90-04.97	45/49				0 986 486 537		
1.9 D									
1.9 D Turbo		09.90-04.97	50/62				0 986 486 537		
2.0		05.97-06.03	50/62				0 986 486 538		
2.4 D		05.97-06.03	55				0 986 486 538		
2.4 D, D Syncro		09.90-04.97	57/81/85				0 986 486 537		
2.5, Syncro		05.97-06.03	57/81/85				0 986 486 538		
2.5 TDI		05.98-06.03	65/150				0 986 486 538		
2.8									
 1.8		09.90-06.03	45/49/50/				0 204 031 292 ¹⁰		
1.9 D, D Turbo			55/57/62/						
2.0			65/75/81/						
2.4 D, D Syncro			85/103/						
2.5, Syncro, TDI, TDI Syncro			111/150						
2.8									
 1.8		12.90-07.92	49				1 987 477 171	↔ 854	
1.9 D, D Turbo		09.90-02.97	45/50/62	Fg.Nr. →70..V..120 000	SBR		1 987 477 706	↔ 938	
2.0		09.90-06.03	45/50/62		TBR		1 987 477 171	↔ 854	
		03.97-06.03	45/50/62	Fg.Nr. 70..V..120 001→	SBR		1 987 477 707	↔ 948	
2.4 D		09.90-02.97	57	Fg.Nr. →70..V..120 000	SBR		1 987 477 706	↔ 938	
		09.90-05.98	57		TBR		1 987 477 171	↔ 854	
		03.97-05.98	57	Fg.Nr. 70..V..120 001→	SBR		1 987 477 707	↔ 948	
		05.97-06.03	55				1 987 477 707	↔ 948	
					TBR		1 987 477 171	↔ 854	
2.4 D Syncro		11.92-04.97	57		SBR		1 987 477 706	↔ 938	
		11.92-09.98	57		TBR		1 987 477 171	↔ 854	
		05.97-09.98	57		SBR		1 987 477 707	↔ 948	
2.5		11.90-12.93	81				1 987 477 171	↔ 854	
		07.94-10.96	81		SBR		1 987 477 706	↔ 938	
		07.94-06.03	81		TBR		1 987 477 171	↔ 854	
		09.95-12.95	81				1 987 477 171	↔ 854	
		08.96-02.97	81	Fg.Nr. →70..V..120 000	SBR		1 987 477 706	↔ 938	
			85	Fg.Nr. →70..V..120 000	SBR		1 987 477 706	↔ 938	
		08.96-06.03	85		TBR		1 987 477 171	↔ 854	
		03.97-06.03	81	Fg.Nr. 70..V..120 001→	SBR		1 987 477 707	↔ 948	
			85	Fg.Nr. 70..V..120 001→	SBR		1 987 477 707	↔ 948	
		05.99-06.03	85		SBR		1 987 477 707	↔ 948	
2.5 Syncro		11.92-04.97	81/85		SBR		1 987 477 706	↔ 938	
		11.92-06.03	81/85		TBR		1 987 477 171	↔ 854	
		05.97-06.03	81/85		SBR		1 987 477 707	↔ 948	
2.5 TDI		01.95-02.97	75	Fg.Nr. →70..V..120 000	SBR		1 987 477 706	↔ 938	
		01.95-06.03	75		TBR		1 987 477 171	↔ 854	
		03.97-06.03	75	Fg.Nr. 70..V..120 001→	SBR		1 987 477 707	↔ 948	
		05.98-06.03	65		SBR		1 987 477 707	↔ 948	
					TBR		1 987 477 171	↔ 854	
			111		SBR		1 987 477 707	↔ 948	
					TBR		1 987 477 171	↔ 854	
		05.99-06.03	75		SBR		1 987 477 707	↔ 948	
2.5 TDI Syncro		03.98-06.03	75		SBR		1 987 477 707	↔ 948	
					TBR		1 987 477 171	↔ 854	
		04.01-06.03	75				1 987 477 706	↔ 938	





 ◀ VW Caravelle T4 [70, 7D]

	2.8	01.96-02.97	103	Fg.Nr. →70..V..120 000	SBR	1987 477 706	↔ 938
		01.96-05.00	103		TBR	1987 477 171	↔ 854
		03.97-05.00	103	Fg.Nr. 70..V..120 001→	SBR	1987 477 707	↔ 948
		05.00-06.03	150		SBR	1987 477 707	↔ 948
					TBR	1987 477 171	↔ 854
	1.8	12.90-07.92	49			0 265 202 454 ²⁰	
	1.9 D, D Turbo	09.90-06.03	45/50/55/57/62/65/75/81/85/111			0 265 202 454 ²⁰	
	2.0	01.96-06.03	45/50/55/57/62/65/			0 265 220 434 ¹⁴	
	2.4 D, D Syncro		75/81/85/111				
	2.5, Syncro, TDI, TDI Syncro						
	2.8	01.96-05.00	103			0 265 202 454 ²⁰	
		10.97-05.00	103	Fg.Nr. 70..W..062 420→		0 265 220 434 ¹⁴	
		05.00-06.03	150			0 265 202 454 ²⁰	
						0 265 220 434 ¹⁴	
	1.8	09.90-12.95	45/49/50/62			0 265 100 072 ¹⁶	
	1.9 D, D Turbo	09.90-06.03	45/49/50/62		1KX,326	0 265 109 612 ²⁰	
	2.0				281,284,GRG	0 265 109 602 ²⁰	
	2.4 D	05.97-06.03	55		1KX,326	0 265 109 612 ²⁰	
					281,284,GRG	0 265 109 602 ²⁰	
	2.4 D, D Syncro	09.90-12.95	57/81			0 265 100 072 ¹⁶	
	2.5	09.90-06.03	57/81		1KX,326	0 265 109 612 ²⁰	
					281,284,GRG	0 265 109 602 ²⁰	
	2.5	08.96-06.03	85		1KX,326	0 265 109 612 ²⁰	
					281,284,GRG	0 265 109 602 ²⁰	
	2.5 Syncro	11.92-12.95	81			0 265 100 072 ¹⁶	
		11.92-10.96	81		1KX,326	0 265 109 612 ²⁰	
					281,284,GRG	0 265 109 602 ²⁰	
		06.97-11.01	81		1KX,326	0 265 109 612 ²⁰	
					281,284,GRG	0 265 109 602 ²⁰	
	2.5 Syncro	08.96-06.03	65/85		1KX,326	0 265 109 612 ²⁰	
	2.5 TDI				281,284,GRG	0 265 109 602 ²⁰	
	2.5 TDI	01.95-12.95	75			0 265 100 072 ¹⁶	
		01.95-06.03	75		1KX,326	0 265 109 612 ²⁰	
					281,284,GRG	0 265 109 602 ²⁰	
	05.98-06.03	111		1KX,326	0 265 109 612 ²⁰		
				281,284,GRG	0 265 109 602 ²⁰		
2.5 TDI Syncro	03.98-06.03	75		1KX,326	0 265 109 612 ²⁰		
				281,284,GRG	0 265 109 602 ²⁰		
	04.01-05.02	75	Fg.Nr. →70..3..019 101	GRG	0 265 109 602 ²⁰		
	06.02-06.03	75	Fg.Nr. 70..3..019 102→		0 265 109 612 ²⁰		
2.8	01.96-06.03	103/150		1KX,326	0 265 109 612 ²⁰		
				281,284,GRG	0 265 109 602 ²⁰		
	1.8	12.90-07.92	49			0 265 006 407 ³	
					LAB,MVB	0 265 006 508 ⁴	
					MVB,RAB	0 265 006 510 ⁴	
					MVB	0 986 594 013 ⁴	
	1.9 D	09.90-12.95	45/50/62	Fg.Nr. →70..T..199 000	MVB	0 986 594 013 ⁴	
	1.9 D Turbo	09.90-06.03	45/50/62			0 265 006 407 ³	
	2.0				LAB,MVB	0 265 006 508 ⁴	
					MVB,RAB	0 265 006 510 ⁴	
		01.96-06.03	45/50/62	Fg.Nr. 70..T..200 001→	LAB,MVB	0 265 006 408 ⁴	
					MVB,RAB	0 265 006 409 ⁴	
2.4 D	05.97-06.03	55			0 265 006 407 ³		
				LAB,MVB	0 265 006 508 ⁴		
				LAB,MVB	0 265 006 408 ⁴		
				MVB,RAB	0 265 006 510 ⁴		
				MVB,RAB	0 265 006 409 ⁴		

		S							
2.4 D		09.90-12.95	57	Fg.Nr. →70..T..199 000	MVB	0 986 594 013 ⁴			
2.4 D Syncro		09.90-09.98	57			0 265 006 407 ³			
					LAB,MVB	0 265 006 508 ⁴			
					MVB,RAB	0 265 006 510 ⁴			
		01.96-09.98	57	Fg.Nr. 70..T..200 001→	LAB, MVB	0 265 006 408 ⁴			
					MVB ,RAB	0 265 006 409 ⁴			
2.5		11.90-12.93	81			0 265 006 407 ³			
					LAB,MVB	0 265 006 508 ⁴			
					MVB,RAB	0 265 006 510 ⁴			
					MVB	0 986 594 013 ⁴			
		07.94-12.95	81	Fg.Nr. →70..T..199 000	MVB	0 986 594 013 ⁴			
		07.94-10.96	81		LAB,MVB	0 265 006 508 ⁴			
					MVB,RAB	0 265 006 510 ⁴			
		07.94-06.03	81			0 265 006 407 ³			
		09.95-12.95	81		MVB	0 986 594 013 ⁴			
		01.96-10.96	81	Fg.Nr. 70..T..200 001→	LAB, MVB	0 265 006 408 ⁴			
					MVB ,RAB	0 265 006 409 ⁴			
		08.96-06.03	81		LAB,MVB	0 265 006 508 ⁴			
					LAB, MVB	0 265 006 408 ⁴			
					MVB,RAB	0 265 006 510 ⁴			
					MVB ,RAB	0 265 006 409 ⁴			
			85			0 265 006 407 ³			
					LAB,MVB	0 265 006 508 ⁴			
					LAB, MVB	0 265 006 408 ⁴			
					MVB,RAB	0 265 006 510 ⁴			
					MVB ,RAB	0 265 006 409 ⁴			
2.5 Syncro		11.92-12.93	81		LAB,MVB	0 265 006 508 ⁴			
					MVB,RAB	0 265 006 510 ⁴			
					MVB	0 986 594 013 ⁴			
		11.92-10.96	81			0 265 006 407 ³			
		01.94-12.95	81	Fg.Nr. →70..T..199 000	MVB	0 986 594 013 ⁴			
		01.94-10.96	81		LAB,MVB	0 265 006 508 ⁴			
					MVB,RAB	0 265 006 510 ⁴			
		01.96-10.96	81	Fg.Nr. 70..T..200 001→	LAB, MVB	0 265 006 408 ⁴			
					MVB ,RAB	0 265 006 409 ⁴			
		06.97-11.01	81			0 265 006 407 ³			
					LAB,MVB	0 265 006 508 ⁴			
					LAB, MVB	0 265 006 408 ⁴			
					MVB,RAB	0 265 006 510 ⁴			
					MVB ,RAB	0 265 006 409 ⁴			
2.5 Syncro		08.96-06.03	65/85			0 265 006 407 ³			
2.5 TDI					LAB,MVB	0 265 006 508 ⁴			
					LAB, MVB	0 265 006 408 ⁴			
					MVB,RAB	0 265 006 510 ⁴			
					MVB ,RAB	0 265 006 409 ⁴			
2.5 TDI		01.95-12.95	75	Fg.Nr. →70..T..199 000	MVB	0 986 594 013 ⁴			
		01.95-06.03	75			0 265 006 407 ³			
					LAB,MVB	0 265 006 508 ⁴			
					MVB,RAB	0 265 006 510 ⁴			
		01.96-06.03	75	Fg.Nr. 70..T..200 001→	LAB, MVB	0 265 006 408 ⁴			
					MVB ,RAB	0 265 006 409 ⁴			
		05.99-06.03	75		LAB, MVB	0 265 006 408 ⁴			
					MVB ,RAB	0 265 006 409 ⁴			
2.5 TDI		03.98-06.03	75/103/			0 265 006 407 ³			
2.5 TDI Syncro			111/150		LAB,MVB	0 265 006 508 ⁴			
					LAB, MVB	0 265 006 408 ⁴			
					MVB,RAB	0 265 006 510 ⁴			
					MVB ,RAB	0 265 006 409 ⁴			





	◀ VW Caravelle T4 [70, 7D]						
2.8	01.96-06.03	75/103/ 111/150			0 265 006 407 ³		
				LAB,MVB	0 265 006 508 ⁴		
				LAB,MVB	0 265 006 408 ⁴		
				MVB,RAB	0 265 006 510 ⁴		
				MVB,RAB	0 265 006 409 ⁴		

	1.8 1.9 D, D Turbo 2.0 2.4 D, D Syncro 2.5, Syncro, TDI, TDI Syncro 2.8	09.90-06.03	45/49/50/ 55/57/62/ 65/75/81/ 85/103/ 111/150		0 265 005 214		
--	--	-------------	---	--	---------------	--	--

Caravelle T5 [7E]

	2.0 2.0 TDI 2.0 TDI 4 Motion	09.09→	62/75/85/ 103/132	L55	1 987 481 182	558	

	2.0 2.0 TDI 2.0 TDI 4 Motion	09.09→	62/75/85/ 103		0 986 473 193		← 60
					0 986 474 193		→ 60

	2.0 2.0 TDI 2.0 TDI 4 Motion	09.09→	62/75/85/ 103/132		1 987 476 309 ¹	250	

	2.0 2.0 TDI 2.0 TDI 4 Motion	09.09→	62/75/85/ 103/132				1 987 470 040 ⁷
--	------------------------------------	--------	----------------------	--	--	--	----------------------------

	2.0, TDI 2.0 TDI 4 Motion	09.09→ 09.09→	62/75/85/103/132 103/132	PR-Nr. 1CP FLR	1 987 477 260 1 987 482 017	↔ 1297 ↔ 2015	

Caravelle T5 [7H]

	1.9 TDI 2.0 2.5 TDI, TDI 4 Motion 3.2, 4 Motion	02.03-11.09	62/63/75/ 77/85/96/ 120/128/ 170/173	L55	1 987 481 182	558	

	1.9 TDI 2.0 2.5 TDI, TDI 4 Motion 3.2, 4 Motion	02.03-11.09	62/63/75/ 77/85/96/ 120/128/ 170/173	308 333	0 986 473 193 0 986 474 193 0 986 473 181 0 986 474 181		← 60 → 60 ← 59,96 → 59,96
--	--	-------------	---	------------	--	--	------------------------------------

	1.9 TDI 2.0 2.5 TDI, TDI 4 Motion 3.2, 4 Motion	02.03-11.09	62/63/75/ 77/85/96/ 120/128/ 170/173	PR-Nr. OWR LAB RAB	1 987 476 309 ¹ 1 987 476 310 ² 1 987 476 313 ² 1 987 476 320 ²	250 190 243 243	



	1.9 TDI 2.0 2.5 TDI, TDI 4 Motion 3.2, 4 Motion	02.03-11.09	62/63/75/ 77/85/96/ 120/128/ 170/173		294 322			1987 470 040 ⁷ 0 986 473 188 ← 44 0 986 474 188 → 44 1987 470 506 ⁸ 1987 470 506 ⁸
--	--	-------------	---	--	------------	--	--	---



	1.9 TDI 2.0 2.5 TDI	04.03-11.09	62/63/75/ 77/85	PR-Nr. 1AT			0 986 480 992	27
		02.03-11.09	96 128		LLE		0 986 480 992	27
		11.03-11.09	120	PR-Nr. 1AT			0 986 480 992	27
		01.06-11.09	96 128	PR-Nr. 1AT			0 986 480 992	27
				PR-Nr. 1AT			0 986 480 992	27
	2.5 TDI 4 Motion	07.04-11.09	96/128		LLE		0 986 480 992	27
		01.06-11.09	96/128				0 986 480 992	27
	3.2	02.03-06.04	170	PR-Nr. 1AT			0 986 480 992	27
		05.03-11.09	173	PR-Nr. 1AT			0 986 480 992	27
	3.2 4 Motion	07.04-11.09	173				0 986 480 992	27

	1.9 TDI 2.0 2.5 TDI	02.03-11.09	62/63/75/ 77/85/96/ 120/128	PR-Nr. OWN, PR-Nr. OWP, PR-Nr. OWQ, PR-Nr. OWL, PR-Nr. OWM			1 987 477 260	↔ 1297
				PR-Nr. OWR			1 987 482 014	↔ 1270
	2.5 TDI 4 Motion	07.04-11.09	96/128		FKR		1 987 482 016	↔ 1650
					FLR		1 987 482 017	↔ 2015
	3.2	02.03-06.04	170	PR-Nr. OWN, PR-Nr. OWP, PR-Nr. OWQ, PR-Nr. OWL, PR-Nr. OWM			1 987 477 260	↔ 1297
				PR-Nr. OWR			1 987 482 014	↔ 1270
		05.03-11.09	173	PR-Nr. OWN, PR-Nr. OWP, PR-Nr. OWQ, PR-Nr. OWL, PR-Nr. OWM			1 987 477 260	↔ 1297
				PR-Nr. OWR			1 987 482 014	↔ 1270
	3.2 4 Motion	07.04-11.09	173		FKR		1 987 482 016	↔ 1650
					FLR		1 987 482 017	↔ 2015

	1.9 TDI 2.0 2.5 TDI, TDI 4 Motion 3.2, 4 Motion	02.03-11.09	62/63/75/ 77/85/96/ 120/128/ 170/173		LAB		0 986 594 504 0 986 594 504 ³ 0 986 594 504 ⁴	
					RAB		0 986 594 505 0 986 594 505 ³ 0 986 594 505 ⁴	

Crafter 30 [2E]



	2.5 TDI	04.06→	65/80/100/ 120	PR-Nr. 5EV, PR-Nr. 5EX PR-Nr. 5EW			0 204 051 514 0 204 255 049	25,4
	2.5 TDI	04.06→	65/80/100/ 120				0 204 051 341	



◀ VW Crafter 30 [2E]

	2.5 TDI	04.06-04.07	65/80/100/120	PR-Nr. C8Y, PR-Nr. CWF, Fg.Nr. →2E..7..032 951, →2F..7..016 103	1987 482 034	↔ 1432
		04.06→	65/80/100/120	PR-Nr. CM1, PR-Nr. COG, PR-Nr. OWF	1987 482 033	↔ 1394
				PR-Nr. OE1	1987 482 027	1468
				PR-Nr. OE2, PR-Nr. OE6	1987 482 029	2522
				PR-Nr. OE3	1987 482 031	2425
					1987 482 028	1867
					1987 482 030	1771
			PR-Nr. OWC, PR-Nr. OWL	1987 482 032	↔ 1666	
	2.5 TDI	04.06-03.08	65/80/100/120	PR-Nr. OWF	0 265 234 100 ²⁶	
				PR-Nr. OWL, PR-Nr. OWC	0 265 234 098 ²⁶	
		04.06→	65/80/100/120	PR-Nr. OWF AA	0 265 235 028 ²⁶	
	2.5 TDI	04.06→	65/80/100/120		0 265 005 628	

Crafter 35 [2E]



	2.5 TDI	04.06→	65/80/100/120	PR-Nr. 5EV, PR-Nr. 5EX	0 204 051 514	
				PR-Nr. 5EW	0 204 255 049	25,4
	2.5 TDI	04.06→	65/80/100/120		0 204 051 341	
	2.5 TDI	04.06-04.07	65/80/100/120	PR-Nr. C8Y, PR-Nr. CWF, Fg.Nr. →2E..7..032 951, →2F..7..016 103	1987 482 034	↔ 1432
		04.06→	65/80/100/120	PR-Nr. CM1, PR-Nr. COG, PR-Nr. OWF	1987 482 033	↔ 1394
				PR-Nr. OE1	1987 482 027	1468
				PR-Nr. OE2, PR-Nr. OE6	1987 482 029	2522
					1987 482 031	2425
				PR-Nr. OE3	1987 482 028	1867
					1987 482 030	1771
			PR-Nr. OWC, PR-Nr. OWL	1987 482 032	↔ 1666	
	2.5 TDI	04.06-03.08	65/80/100/120	PR-Nr. OWF	0 265 234 100 ²⁶	
				PR-Nr. OWL, PR-Nr. OWC	0 265 234 098 ²⁶	
		04.06→	65/80/100/120	PR-Nr. OWF AA	0 265 235 028 ²⁶	
	2.5 TDI	04.06→	65/80/100/120		0 265 005 628	

Crafter 50 [2E]



	2.5 TDI	04.06→	80/100/120	PR-Nr. 5EV, PR-Nr. 5EX	0 204 051 514	
				PR-Nr. 5EW	0 204 255 049	25,4



	2.5 TDI	04.06→	80/100/ 120			0 204 051 341	
	2.5 TDI	04.06-04.07	80/100/ 120	PR-Nr. C8Y, PR-Nr. CWF, Fg.Nr. →2E..7..032 951, →2F..7..016 103		1 987 482 034	↔ 1432
		04.06→	80/100/ 120	PR-Nr. CM1, PR-Nr. COG, PR-Nr. OWF		1 987 482 033	↔ 1394
				PR-Nr. OE1		1 987 482 027	1468
				PR-Nr. OE2, PR-Nr. OE6		1 987 482 029	2522
						1 987 482 031	2425
				PR-Nr. OE3		1 987 482 028	1867
						1 987 482 030	1771
				PR-Nr. OWC, PR-Nr. OWL		1 987 482 032	↔ 1666

	2.5 TDI	04.06-03.08	80/100/ 120	PR-Nr. OWF		0 265 234 100 ²⁶	
				PR-Nr. OWL, PR-Nr. OWC		0 265 234 098 ²⁶	
		04.06→	80/100/ 120	PR-Nr. OWF	AA	0 265 235 028 ²⁶	

	2.5 TDI	04.06→	80/100/ 120			0 265 005 628	
--	---------	--------	----------------	--	--	---------------	--

Eurovan [70]



	2.4 D	09.91-12.95	57/81			1 987 476 411	330
	2.5	01.96-04.97	57/81			1 987 476 698	375
	2.8	05.96-05.00	103			1 987 476 698	375
		05.00-04.01	150	Fg.Nr. →70-X-250 000	15Z	1 987 476 698	375
		05.00-06.03	150	Fg.Nr. 70-Y-000 000→	15Z	1 987 476 698	→ 375

	2.4 D	07.93-04.97	57	Fg.Nr. 70-P-160 001→	281,FSB, LUC INB	0 986 473 177	↔ 53,93
						0 986 474 177	↔ 53,93
	2.5	09.91-05.96	81		281,INB LUC	0 986 473 806	↔ 54
						0 986 473 807	↔ 54
		01.94-05.96	81	Fg.Nr. 70-P-160 001→	281,FSB, LUC INB	0 986 473 177	↔ 53,93
						0 986 474 177	↔ 53,93
		01.96-05.96	81		284,FSB	0 986 473 361	↔ 56,93
						0 986 474 361	↔ 56,93
	2.8	05.00-06.03	150		284,FSB ATE	0 986 473 361	↔ 56,93 1 987 470 005 ⁷
						0 986 473 361	↔ 56,93 1 987 470 506 ⁸
						0 986 474 361	↔ 56,93 1 987 470 506 ⁸
				Fg.Nr. 70-Y-000 001→	284,RSB LUC	0 986 473 806	↔ 54
						0 986 473 807	↔ 54
		06.00-06.03	150	Fg.Nr. 70-1-000 955→	326,FSB	0 986 473 184	↔ 57 1 987 470 005 ⁷
						0 986 474 184	↔ 57 1 987 470 005 ⁷



















	2.4 D	09.91-04.97	57/81			1 987 476 220	160
	2.5						
	2.8	05.00-06.03	150		SSZ	1 987 476 220	160

	2.4 D	09.91-12.95	57/81			0 986 475 935	↔ 20,64
	2.5						





























◀ VW Eurovan [70]									
	2.4D	ABO	05.95-04.97	57/81	Fg.Nr. 70-S-127 806→	LUC	0 986 480 930	23,8	
	2.5	ABS	09.91-05.95	57/81	Fg.Nr. →70-S-127 805	LLE	0 986 480 834	22,19	
	2.8	ABO	05.00-06.03	150	Fg.Nr. 70-T-200 001→		0 986 480 930	23,8	
		ABS	05.00-06.03	150	Fg.Nr. 70-T-200 001→	EDS	0 986 480 933	23,8	
	2.8		05.00-06.03	150			0 986 486 037		
	2.8		05.00-06.03	150	Fg.Nr. 70-V-020 001→		0 986 486 538		
	2.4D		10.92-04.97	57			0 204 031 292		
	2.8		05.00-06.03	150			0 204 031 292 ¹⁰		
	2.8		05.00-06.03	150		294	1 987 477 707	↔ 948	
	2.8		05.00-06.03	150			0 265 202 454 ²⁰		
	2.4D		09.91-04.97	57/81			0 265 100 072 ¹⁶		
	2.5								
	2.8		05.00-06.03	150		15Z,GRG	0 265 109 602 ²⁰		
					16Z	0 265 109 612 ²⁰			
	2.4D		10.92-12.95	57	Fg.Nr. →70-H-199 999		0 265 006 407 ³		
					Fg.Nr. →70-T 199 999		0 986 594 013 ⁴		
			01.96-04.97	57	Fg.Nr. 70-H-200 001→		0 265 006 407 ³		
					Fg.Nr. 70-T-200 001→	LAB	0 265 006 408 ⁴		
	2.5		09.91-12.93	81	Fg.Nr. 70-N-065 312→	LAB	0 986 594 013 ⁴		
					70-T-199 999				
			09.91-12.95	81	Fg.Nr. 70-N-065 574→	RAB	0 986 594 013 ⁴		
					70-T-199 999				
	2.8		05.96-05.00	103	Fg.Nr. →70-H-199 999		0 265 006 407 ³		
					Fg.Nr. →70-T 199 999		0 986 594 013 ⁴		
	2.8		05.00-06.03	150	Fg.Nr. 70-T-200 001→	RAB	0 265 006 409 ⁴		
							0 265 006 407 ³		
						LAB,MVB	0 265 006 508 ⁴		
						LAB,MVB	0 265 006 408 ⁴		
						MVB,RAB	0 265 006 510 ⁴		
					MVB,RAB	0 265 006 409 ⁴			
	2.8	ESP	05.00-06.03	150			0 265 005 214		
Golf I Bakkie [15, 16]									
	1.6		06.96→	60					0 204 104 144 ⁷

		S							
									
	1.8	12.88-12.95	70				0 986 475 260	↔ 17,46	
									
	1.8	12.88-12.95	70			RLE	0 986 480 430	20,64	1 987 472 282 ⁶
LT [2D, 2H]									
									
	28 2.3, 2.5 SDI, 2.5 TDI 28 2.8 D Turbo, 2.8 TDI	05.96-04.06	55/61/66/70/75/80/ 92/96/105/116				1 987 476 295		
	35 2.3, 2.5 SDI, 2.5 TDI 35 2.8 D Turbo, 2.8 TDI	05.96-04.06	55/61/66/ PR-Nr. 2UA 70/75/80/ PR-Nr. 2UB 92/96/105/ 116				1 987 476 295 1 987 481 020	410	
	46 2.3, 2.5 SDI, 2.5 TDI 46 2.8 D Turbo, 2.8 TDI	05.96-04.06	55/61/66/70/75/80/ 92/96/105/116				1 987 476 295		
	28 2.3, 2.5 SDI, 2.5 TDI 28 2.8 D Turbo, 2.8 TDI	05.96-04.06	55/61/66/ 70/75/80/ 92/96/105/ 116				0 986 473 249 0 986 474 249	← 60 → 60	
	35 2.3, 2.5 SDI, 2.5 TDI 35 2.8 D Turbo, 2.8 TDI								
	46 2.3 46 2.5 SDI 46 2.5 TDI	05.96-11.01	55/105				0 986 473 250 0 986 474 250	← 44 → 44	
		05.96-05.99	75				0 986 473 250 0 986 474 250	← 44 → 44	
		05.99-04.01	66				0 986 473 250 0 986 474 250	← 44 → 44	
		05.99-05.02	80	Fg.Nr. →2D..3H003 239			0 986 473 250 0 986 474 250	← 44 → 44	
		04.01-05.02	61	Fg.Nr. →2D..3H003 239			0 986 473 250 0 986 474 250	← 44 → 44	
			70	Fg.Nr. →2D..3H003 239			0 986 473 250 0 986 474 250	← 44 → 44	
	46 2.8 D Turbo	07.97-01.02	92/96				0 986 473 250 0 986 474 250	← 44 → 44	
	46 2.8 TDI	02.02-05.02	116	Fg.Nr. →2D..3H003 239			0 986 473 250 0 986 474 250	← 44 → 44	
									
	28 2.3, 2.5 SDI, 2.5 TDI 28 2.8 D Turbo, 2.8 TDI	05.96-04.06	55/61/66/ 70/75/80/ 92/96/105/ 116				1 987 476 295		
	35 2.3, 2.5 SDI, 2.5 TDI 35 2.8 D Turbo, 2.8 TDI								
	46 2.3 46 2.5 SDI	05.96-11.01	55/105				1 987 481 003 1 987 481 003 ¹ 1 987 481 008 1 987 481 008 ²	370 370 235 235	



			S																	
	◀ VW LT [2D, 2H]																			
	46 2.5 TDI	05.96-05.99	75							1987 481 003	370									
										1987 481 003 ¹	370									
										1987 481 008	235									
										1987 481 008 ²	235									
										05.99-04.01	66								1987 481 003	370
																			1987 481 003 ¹	370
																			1987 481 008	235
																			1987 481 008 ²	235
										05.99-12.03	80	Fg.Nr. →2D..4..020 680							1987 481 008	235
																			1987 481 008 ²	235
										05.99-04.06	80								1987 481 003	370
																			1987 481 003 ¹	370
										04.01-12.03	61	Fg.Nr. →2D..4..020 680							1987 481 008	235
																			1987 481 008 ²	235
											70	Fg.Nr. →2D..4..020 680							1987 481 008	235
																			1987 481 008 ²	235
										04.01-04.06	61								1987 481 003	370
																			1987 481 003 ¹	370
											70								1987 481 003	370
																			1987 481 003 ¹	370
01.04-04.06	61	Fg.Nr. 2D..4..020 681→							1987 476 295 ²											
	70	Fg.Nr. 2D..4..020 681→							1987 476 295 ²											
	80	Fg.Nr. 2D..4..020 681→							1987 476 295 ²											
46 2.8 D Turbo	07.97-01.02	92/96							1987 481 003	370										
									1987 481 003 ¹	370										
									1987 481 008	235										
									1987 481 008 ²	235										
46 2.8 TDI	02.02-12.03	116	Fg.Nr. →2D..4..020 680						1987 481 008	235										
									1987 481 008 ²	235										
	02.02-04.06	116							1987 481 003	370										
									1987 481 003 ¹	370										
	01.04-04.06	116	Fg.Nr. 2D..4..020 681→						1987 476 295 ²											
	28 2.3, 2.5 SDI, 2.5 TDI	05.96-04.06	55/61/66/70/75/80/ 92/96/105/116							0986 473 363	← 44,93	1987 470 506 ⁸								
										0986 474 363	→ 44,93	1987 470 506 ⁸								
										35 2.3	05.96-04.06	55/61/66/				ATE	0986 473 353	← 51,92	1987 470 506 ⁸	
										35 2.5 SDI		70/75/80/					0986 474 353	→ 51,92	1987 470 506 ⁸	
										35 2.5 TDI		92/96/105/				BO	0204 102 918	← 52		
										35 2.8 D Turbo		116					0986 473 359			
										35 2.8 TDI							0204 102 919	→ 52		
																	0986 474 359			
										46 2.3	05.96-06.01	105	Fg.Nr. →2D..2H005 686					0986 473 250	← 44	
																		0986 474 250	→ 44	
	07.01-11.01	105	Fg.Nr. 2D..2H005 687→					0986 473 363	← 44,93											
								0986 474 363	→ 44,93											
46 2.5 SDI	05.96-04.01	55						0986 473 250	← 44											
								0986 474 250	→ 44											
46 2.5 TDI	05.96-05.99	75						0986 473 250	← 44											
								0986 474 250	→ 44											
	05.99-04.01	66						0986 473 250	← 44											
								0986 474 250	→ 44											
	05.99-06.01	80	Fg.Nr. →2D..2H005 686					0986 473 250	← 44											
								0986 474 250	→ 44											
	04.01-06.01	61	Fg.Nr. →2D..2H005 686					0986 473 250	← 44											
								0986 474 250	→ 44											
		70	Fg.Nr. →2D..2H005 686					0986 473 250	← 44											
								0986 474 250	→ 44											
	07.01-12.03	61	Fg.Nr. 2D..2H005 687→					0986 473 363	← 44,93											
			2D..4..020 680					0986 474 363	→ 44,93											
		70	Fg.Nr. 2D..2H005 687→					0986 473 363	← 44,93											
			2D..4..020 680					0986 474 363	→ 44,93											
		80	Fg.Nr. 2D..2H005 687→					0986 473 363	← 44,93											
			2D..4..020 680					0986 474 363	→ 44,93											

		S											
46 2.5 TDI	12.02-12.03	80	Fg.Nr. →2D..4..020 680	0 986 473 363		44,93							
				0 986 474 363		44,93							
	01.04-04.06	61	Fg.Nr. 2D..4..020 681→	0 986 473 231		44							
				0 986 474 231		44							
				0 986 473 231		44							
				0 986 474 231		44							
46 2.8 D Turbo	07.97-12.98	92		0 986 473 250		44							
				0 986 474 250		44							
	01.99-06.01	96	Fg.Nr. →2D..2H005 686	0 986 473 250		44							
				0 986 474 250		44							
				0 986 473 363		44,93							
				0 986 474 363		44,93							
46 2.8 TDI	02.02-12.03	116	Fg.Nr. →2D..4..020 680	0 986 473 363		44,93							
				0 986 474 363		44,93							
	01.04-04.06	116	Fg.Nr. 2D..4..020 681→	0 986 473 231		44							
				0 986 474 231		44							
													
													
28 2.3	ABO	05.96-08.01	105	Fg.Nr. →2D..2H011 024	0 204 123 483		23,8						
					ABS	05.96-08.01	105	Fg.Nr. →2D..2H011 024	F 026 003 484		23,8		
28 2.5 SDI	ABO	05.96-04.01	55		0 204 123 483		23,8						
					ABS	05.96-04.01	55		F 026 003 484		23,8		
28 2.5 TDI	ABO	05.96-05.99	75		0 204 123 483		23,8						
					05.99-04.01	66		0 204 123 483		23,8			
	05.99-08.01	80	Fg.Nr. →2D..2H011 024	0 204 123 483		23,8							
				04.01-08.01	61	Fg.Nr. →2D..2H011 024	0 204 123 483		23,8				
				70	Fg.Nr. →2D..2H011 024	0 204 123 483		23,8					
	ABS	05.96-05.99	75		F 026 003 484		23,8						
					05.99-04.01	66		F 026 003 484		23,8			
					05.99-08.01	80	Fg.Nr. →2D..2H011 024	F 026 003 484		23,8			
					04.01-08.01	61	Fg.Nr. →2D..2H011 024	F 026 003 484		23,8			
	28 2.8 D Turbo	ABO	07.97-12.98	92		0 204 123 483		23,8					
01.99-08.01						96	Fg.Nr. →2D..2H011 024	0 204 123 483		23,8			
ABS		07.97-12.98	92		F 026 003 484		23,8						
					01.99-08.01	96	Fg.Nr. →2D..2H011 024	F 026 003 484		23,8			
					35 2.3								
					ABO	05.96-08.01	105	Fg.Nr. →2D..2H011 024	0 204 123 483		23,8		
ABS	05.96-08.01	105	Fg.Nr. →2D..2H011 024	F 026 003 484						23,8			
35 2.5 SDI	ABO	05.96-04.01	55		0 204 123 483		23,8						
					ABS	05.96-04.01	55		F 026 003 484		23,8		
35 2.5 TDI	ABO	05.96-05.99	75		0 204 123 483		23,8						
					05.99-04.01	66		0 204 123 483		23,8			
	05.99-08.01	80	Fg.Nr. →2D..2H011 024	0 204 123 483		23,8							
				04.01-08.01	61	Fg.Nr. →2D..2H011 024	0 204 123 483		23,8				
				70	Fg.Nr. →2D..2H011 024	0 204 123 483		23,8					
	ABS	05.96-05.99	75		F 026 003 484		23,8						
					05.99-04.01	66		F 026 003 484		23,8			
					05.99-08.01	80	Fg.Nr. →2D..2H011 024	F 026 003 484		23,8			
					04.01-08.01	61	Fg.Nr. →2D..2H011 024	F 026 003 484		23,8			
	35 2.8 D Turbo	ABO	07.97-12.98	92		0 204 123 483		23,8					
01.99-08.01						96	Fg.Nr. →2D..2H011 024	0 204 123 483		23,8			
ABS		07.97-12.98	92		F 026 003 484		23,8						
					01.99-08.01	96	Fg.Nr. →2D..2H011 024	F 026 003 484		23,8			
					46 2.3								
					ABO	05.96-08.01	105	Fg.Nr. →2D..2H011 024	0 204 123 483		23,8		
ABS	05.96-08.01	105	Fg.Nr. →2D..2H011 024	F 026 003 484						23,8			
					254		0 204 123 370		25,4				



			S						
	◀ VW LT [2D, 2H]								
46 2.5 SDI	ABO 05.96-04.01 55						0 204 123 483	23,8	
	ABS 05.96-04.01 55						F 026 003 484	23,8	
						254	0 204 123 370	25,4	
46 2.5 TDI	ABO 05.96-05.99 75						0 204 123 483	23,8	
	05.99-04.01 66						0 204 123 483	23,8	
	05.99-08.01 80 Fg.Nr. →2D..2H011 024						0 204 123 483	23,8	
	04.01-08.01 61 Fg.Nr. →2D..2H011 024						0 204 123 483	23,8	
	70 Fg.Nr. →2D..2H011 024						0 204 123 483	23,8	
	ABS 05.96-05.99 75						F 026 003 484	23,8	
						254	0 204 123 370	25,4	
	05.99-04.01 66						F 026 003 484	23,8	
						254	0 204 123 370	25,4	
	05.99-08.01 80 Fg.Nr. →2D..2H011 024						F 026 003 484	23,8	
						254	0 204 123 370	25,4	
	04.01-08.01 61 Fg.Nr. →2D..2H011 024						F 026 003 484	23,8	
	70 Fg.Nr. →2D..2H011 024						F 026 003 484	23,8	
						254	0 204 123 370	25,4	
46 2.8 D Turbo	ABO 07.97-12.98 92						0 204 123 483	23,8	
	01.99-08.01 96 Fg.Nr. →2D..2H011 024						0 204 123 483	23,8	
	ABS 07.97-12.98 92						F 026 003 484	23,8	
						254	0 204 123 370	25,4	
	01.99-08.01 96 Fg.Nr. →2D..2H011 024						F 026 003 484	23,8	
						254	0 204 123 370	25,4	
	28 2.3	05.96-08.01 105				Fg.Nr. →2D..2H011 024	0 204 125 741		
	28 2.5 SDI	05.96-04.01 55					0 204 125 741		
	28 2.5 TDI	05.96-05.99 75					0 204 125 741		
		05.99-04.01 66					0 204 125 741		
		05.99-08.01 80				Fg.Nr. →2D..2H011 024	0 204 125 741		
		04.01-08.01 61				Fg.Nr. →2D..2H011 024	0 204 125 741		
		70				Fg.Nr. →2D..2H011 024	0 204 125 741		
	28 2.8 D Turbo	07.97-12.98 92					0 204 125 741		
		01.99-08.01 96/105				Fg.Nr. →2D..2H011 024	0 204 125 741		
	35 2.3, 2.8 D Turbo	05.96-08.01 96/105				Fg.Nr. →2D..2H011 024	0 204 125 741		
	35 2.5 SDI	05.96-04.01 55					0 204 125 741		
	35 2.5 TDI	05.96-05.99 75					0 204 125 741		
		05.99-04.01 66					0 204 125 741		
		05.99-08.01 80				Fg.Nr. →2D..2H011 024	0 204 125 741		
		04.01-08.01 61				Fg.Nr. →2D..2H011 024	0 204 125 741		
		70				Fg.Nr. →2D..2H011 024	0 204 125 741		
	35 2.8 D Turbo	07.97-12.98 92					0 204 125 741		
	46 2.3	05.96-08.01 96/105				Fg.Nr. →2D..2H011 024	0 204 125 741		
	46 2.5 SDI	05.96-04.01 55					0 204 125 741		
	46 2.5 TDI	05.96-05.99 75					0 204 125 741		
		05.99-04.01 66					0 204 125 741		
		05.99-08.01 80				Fg.Nr. →2D..2H011 024	0 204 125 741		
		04.01-08.01 61				Fg.Nr. →2D..2H011 024	0 204 125 741		
		70				Fg.Nr. →2D..2H011 024	0 204 125 741		
	46 2.8 D Turbo	07.97-12.98 92					0 204 125 741		
		01.99-08.01 96				Fg.Nr. →2D..2H011 024	0 204 125 741		
	28 2.3, 2.5 SDI, 2.5 TDI	05.96-04.06	55/61/66/				0986 486 053		
	28 2.8 D Turbo, 2.8 TDI		70/75/80/						
	35 2.3, 2.5 SDI, 2.5 TDI		92/96/105/						
	35 2.8 D Turbo, 2.8 TDI		116						
	46 2.3, 2.5 SDI, 2.5 TDI								
	46 2.8 D Turbo, 2.8 TDI								
	28 2.3, 2.5 SDI, 2.5 TDI	05.96-04.06	55/61/66/				0986 486 546		
	35 2.3, 2.5 SDI, 2.5 TDI		70/75/80/						
	46 2.3, 2.5 SDI, 2.5 TDI		105						



	28 2.3, 2.5 SDI, 2.5 TDI	05.96-04.06	55/61/66/70/75/80/			0 204 131 248 ¹⁰	
	28 2.8 D Turbo, 2.8 TDI		92/96/105/116				
	35 2.3	ABO 05.96-11.98	55/105	Fg.Nr. →2D..X..021 000		0 204 131 248 ¹⁰	
	35 2.5 SDI	12.98-11.01	55/105	Fg.Nr. 2D..X..021 001→	R30,R35	0 204 131 249 ¹⁰	
					R40	0 204 131 250 ¹⁰	
		ABS 05.96-11.01	55/105			0 204 131 248 ¹⁰	
	35 2.5 TDI	ABO 05.96-11.98	75	Fg.Nr. →2D..X..021 000		0 204 131 248 ¹⁰	
		12.98-05.99	75	Fg.Nr. 2D..X..021 001→	R30,R35	0 204 131 249 ¹⁰	
					R40	0 204 131 250 ¹⁰	
		05.99-04.06	61/66/70		R30,R35	0 204 131 249 ¹⁰	
					R40	0 204 131 250 ¹⁰	
			80		R30,R35	0 204 131 249 ¹⁰	
					R40	0 204 131 250 ¹⁰	
		ABS 05.96-04.06	61/66/70/75/80			0 204 131 248 ¹⁰	
	35 2.8 D Turbo	ABO 07.97-11.98	92	Fg.Nr. →2D..X..021 000		0 204 131 248 ¹⁰	
		12.98-12.98	92	Fg.Nr. 2D..X..021 001→	R30,R35	0 204 131 249 ¹⁰	
					R40	0 204 131 250 ¹⁰	
		01.99-01.02	96		R30,R35	0 204 131 249 ¹⁰	
					R40	0 204 131 250 ¹⁰	
		ABS 07.97-01.02	92/96			0 204 131 248 ¹⁰	
	35 2.8 TDI	ABO 02.02-04.06	116		R30,R35	0 204 131 249 ¹⁰	
					R40	0 204 131 250 ¹⁰	
		ABS 02.02-04.06	116			0 204 131 248 ¹⁰	
	46 2.3	ABO 05.96-11.01	55/105			0 204 131 251 ¹⁰	
	46 2.5 SDI	ABS 05.96-11.01	55/105			0 204 131 248 ¹⁰	
	46 2.5 TDI	ABO 05.96-04.06	61/66/70/75/80			0 204 131 251 ¹⁰	
		ABS 05.96-04.06	61/66/70/75/80			0 204 131 248 ¹⁰	
	46 2.8 D Turbo	ABO 07.97-01.02	92/96			0 204 131 251 ¹⁰	
		ABS 07.97-01.02	92/96			0 204 131 248 ¹⁰	
	46 2.8 TDI	ABO 02.02-04.06	116			0 204 131 251 ¹⁰	
		ABS 02.02-04.06	116			0 204 131 248 ¹⁰	

	28 2.3, 2.5 SDI, 2.5 TDI	05.96-04.06	55/61/66/70/75/80/			1 987 477 852	1522
	28 2.8 D Turbo, 2.8 TDI		92/96/105/116		R30	1 987 477 853	1443
					R35	1 987 477 854	1998
	35 2.3, 2.5 SDI, 2.5 TDI	05.96-04.06	55/61/66/			1 987 477 852	1522
	35 2.8 D Turbo, 2.8 TDI		70/75/80/		R30	1 987 477 853	1443
			92/96/105/		R35	1 987 477 854	1998
			116		R40	1 987 477 855	2468
	46 2.3	05.96-04.06	55/61/66/			1 987 477 858	→ 1532
	46 2.5 SDI		70/75/80/			1 987 477 859	← 1532
	46 2.5 TDI		92/96/105/		R30	1 987 477 853	1443
	46 2.8 D Turbo		116		R35	1 987 482 131	228
	46 2.8 TDI				R40	1 987 477 880	2448

	28 2.3, 2.5 SDI	06.98-11.01	55/105	Fg.Nr. 2D..X..000 053→		0 265 220 489 ¹³	
	28 2.5 TDI	06.98-05.99	75	Fg.Nr. 2D..X..000 053→		0 265 220 489 ¹³	
		05.99-04.06	61/66/70			0 265 220 489 ¹³	
			80			0 265 220 489 ¹³	
	28 2.8 D Turbo	06.98-12.98	92	Fg.Nr. 2D..X..000 053→		0 265 220 489 ¹³	
	28 2.8 D Turbo, 2.8 TDI	01.99-04.06	96/116			0 265 220 489 ¹³	
	35 2.3, 2.5 SDI	06.98-11.01	55/105	Fg.Nr. 2D..X..000 053→		0 265 220 489 ¹³	
	35 2.5 TDI	06.98-05.99	75	Fg.Nr. 2D..X..000 053→		0 265 220 489 ¹³	
		05.99-04.06	61/66/70			0 265 220 489 ¹³	
			80			0 265 220 489 ¹³	
	35 2.8 D Turbo	06.98-12.98	92	Fg.Nr. 2D..X..000 053→		0 265 220 489 ¹³	
	35 2.8 D Turbo, 2.8 TDI	01.99-04.06	96/116			0 265 220 489 ¹³	
	46 2.3, 2.5 SDI	06.98-11.01	55/105	Fg.Nr. 2D..X..000 053→		0 265 220 489 ¹³	
	46 2.5 TDI	06.98-05.99	75	Fg.Nr. 2D..X..000 053→		0 265 220 489 ¹³	
		05.99-04.06	61/66/70/80			0 265 220 489 ¹³	
	46 2.8 D Turbo	06.98-12.98	92	Fg.Nr. 2D..X..000 053→		0 265 220 489 ¹³	
	46 2.8 D Turbo, 2.8 TDI	01.99-04.06	96/116			0 265 220 489 ¹³	





◀ VW LT [2D, 2H]































	28 2.3, 2.5 SDI, 2.5 TDI	05.96-04.06	55/61/66/70/75/80/92/96/105/116	H01	0 265 004 010 ⁴	
	28 2.8 D Turbo, 2.8 TDI	01.97-04.06	55/61/66/	H01	0 265 004 009 ³	
	35 2.3, 2.5 SDI, 2.5 TDI		70/75/80/			
	35 2.8 D Turbo, 2.8 TDI		92/96/105/			
	46 2.3, 2.5 SDI, 2.5 TDI		116			
46 2.8 D Turbo, 2.8 TDI						

LT [28, 29, 21]



	28 2.4	08.89-07.92	66	BMS	1 987 476 139	440
	28 2.4 D	08.89-07.92	55	BMS	1 987 476 139	440
	28 2.4 D Turbo	08.88-04.96	68/70		1 987 476 380	297
		08.89-08.92	66/75	BMS	1 987 476 139	440
		08.89-04.96	68/70	BMS	1 987 476 139	440
	28 2.4	10.88-04.96	51/70		1 987 476 380	297
	28 2.4 D	08.89-04.96	51/70	BMS	1 987 476 139	440
	31 2.4 D	08.89-07.92	55	BMS	1 987 476 139	440
	31 2.4 D Turbo	08.88-04.96	68/70		1 987 476 380	297
		08.89-04.96	68/70	BMS	1 987 476 139	440
	31 2.4	10.88-04.96	51/70		1 987 476 380	297
	31 2.4 D	08.89-04.96	51/70	BMS	1 987 476 139	440
	31 2.4, 2.4 D Turbo	08.89-08.92	66/75	BMS	1 987 476 139	440
	35 2.4 D	08.89-07.92	55	BMS	1 987 476 139	440
	35 2.4 D Turbo	08.88-04.96	68/70		1 987 476 380	297
		08.89-04.96	68/70	BMS	1 987 476 139	440
	35 2.4	10.88-04.96	51/70		1 987 476 380	297
	35 2.4 D	08.89-04.96	51/70	BMS	1 987 476 139	440
	35 2.4, 2.4 D Turbo	08.89-08.92	66/75	BMS	1 987 476 139	440
	40 2.4 D	08.89-07.92	55	BMS	1 987 476 139	440
	40 2.4 D Turbo	08.88-04.96	68/70		1 987 476 380	297
		08.89-04.96	68/70	BMS	1 987 476 139	440
	40 2.4	10.88-04.96	51/70		1 987 476 380	297
	40 2.4 D	08.89-04.96	51/70	BMS	1 987 476 139	440
	40 2.4, 2.4 D Turbo	08.89-08.92	66/75	BMS	1 987 476 139	440
	45 2.4 D	08.89-07.92	55	BMS	1 987 476 139	440
		08.92-04.96	51		1 987 476 380	297
				BMS	1 987 476 139	440
	45 2.4 D Turbo	09.92-04.96	70		1 987 476 380	297
				BMS	1 987 476 139	440
	45 2.4, 2.4 D Turbo	08.89-08.92	66/75	BMS	1 987 476 139	440
	50 2.4	08.89-07.92	66/75	BMS	1 987 476 139	440
	50 2.4 D	08.89-07.92	55	BMS	1 987 476 139	440
		08.92-04.96	51		1 987 476 380	297
				BMS	1 987 476 139	440
	50 2.4 D Turbo	08.89-08.92	75	BMS	1 987 476 139	440
		09.92-04.96	70		1 987 476 380	297
				BMS	1 987 476 139	440
	55 2.4	08.85-07.86	62		1 987 476 380	297
	55 2.4, 2.4 D	08.85-04.96	51/55/66/70/75		1 987 476 380	297
	55 2.4 D Turbo	08.89-04.96	51/55/66/70/75	BMS	1 987 476 139	440

	28 2.4	ABO	10.88-04.96	70		0 986 473 236		57	1 987 470 487 ⁷
						0 986 474 236		57	1 987 470 487 ⁷
		ABS	07.89-04.96	66/70		0 986 473 236		57	1 987 470 487 ⁷
						0 986 474 236		57	1 987 470 487 ⁷

		S								
28 2.4 D	ABO	08.89-07.92	51				0 986 473 236	 ← 57	1 987 470 487 ⁷	
							0 986 474 236	 → 57	1 987 470 487 ⁷	
		08.92-04.96	51						1 987 470 487 ⁷	
	ABS	07.89-07.92	55					0 986 473 236	 ← 57	1 987 470 487 ⁷
								0 986 474 236	 → 57	1 987 470 487 ⁷
		08.89-07.92	51					0 986 473 236	 ← 57	1 987 470 487 ⁷
		08.92-04.96	51						1 987 470 487 ⁷	
28 2.4 D Turbo	ABO	08.88-04.96	68/70				0 986 473 236	 ← 57	1 987 470 487 ⁷	
							0 986 474 236	 → 57	1 987 470 487 ⁷	
	ABS	07.89-04.96	68/70/75					0 986 473 236	 ← 57	1 987 470 487 ⁷
								0 986 474 236	 → 57	1 987 470 487 ⁷
31 2.4	ABO	10.88-04.96	70				0 986 473 236	 ← 57	1 987 470 487 ⁷	
								0 986 474 236	 → 57	1 987 470 487 ⁷
	ABS	07.89-04.96	66/70				0 986 473 236	 ← 57	1 987 470 487 ⁷	
							0 986 474 236	 → 57	1 987 470 487 ⁷	
31 2.4 D	ABO	08.89-07.92	51				0 986 473 236	 ← 57	1 987 470 487 ⁷	
							0 986 474 236	 → 57	1 987 470 487 ⁷	
		08.92-04.96	51						1 987 470 487 ⁷	
	ABS	07.89-07.92	55					0 986 473 236	 ← 57	1 987 470 487 ⁷
								0 986 474 236	 → 57	1 987 470 487 ⁷
		08.89-07.92	51					0 986 473 236	 ← 57	1 987 470 487 ⁷
		08.92-04.96	51						1 987 470 487 ⁷	
31 2.4 D Turbo	ABO	08.88-04.96	68/70				0 986 473 236	 ← 57	1 987 470 487 ⁷	
							0 986 474 236	 → 57	1 987 470 487 ⁷	
	ABS	07.89-04.96	68/70/75					0 986 473 236	 ← 57	1 987 470 487 ⁷
								0 986 474 236	 → 57	1 987 470 487 ⁷
35 2.4	ABO	10.88-04.96	70						1 987 470 487 ⁷	
									1 987 470 487 ⁷	
	ABS	07.89-04.96	66/70						1 987 470 487 ⁷	
35 2.4 D	ABO	08.89-04.96	51						1 987 470 487 ⁷	
									1 987 470 487 ⁷	
	ABS	07.89-07.92	55						1 987 470 487 ⁷	
		08.89-04.96	51						1 987 470 487 ⁷	
35 2.4 D Turbo	ABO	08.88-04.96	68/70						1 987 470 487 ⁷	
									1 987 470 487 ⁷	
	ABS	07.89-04.96	68/70/75						1 987 470 487 ⁷	
40 2.4	ABO	10.88-04.96	70						1 987 470 487 ⁷	
									1 987 470 487 ⁷	
	ABS	07.89-04.96	66/70						1 987 470 487 ⁷	
40 2.4 D	ABO	08.89-04.96	51						1 987 470 487 ⁷	
									1 987 470 487 ⁷	
	ABS	07.89-07.92	55						1 987 470 487 ⁷	
		08.89-04.96	51						1 987 470 487 ⁷	
40 2.4 D Turbo	ABO	08.88-04.96	68/70						1 987 470 487 ⁷	
									1 987 470 487 ⁷	
	ABS	07.89-04.96	66/68/70/75						1 987 470 487 ⁷	
45 2.4	ABS	07.89-07.92	66/68/70/75						1 987 470 487 ⁷	
45 2.4 D	ABO	08.92-04.96	51						1 987 470 487 ⁷	
									1 987 470 487 ⁷	
									1 987 470 487 ⁷	
45 2.4 D Turbo	ABO	09.92-04.96	70						1 987 470 487 ⁷	
									1 987 470 487 ⁷	
									1 987 470 487 ⁷	
	ABS	07.89-08.92	66/75						1 987 470 487 ⁷	
		09.92-04.96	70						1 987 470 487 ⁷	
50 2.4	ABS	07.89-07.92	66/75						1 987 470 487 ⁷	
50 2.4 D	ABO	08.92-04.96	51						1 987 470 487 ⁷	
									1 987 470 487 ⁷	
									1 987 470 487 ⁷	
50 2.4 D Turbo	ABO	09.92-04.96	70						1 987 470 487 ⁷	
									1 987 470 487 ⁷	
									1 987 470 487 ⁷	
	ABS	07.89-08.92	75						1 987 470 487 ⁷	
		09.92-04.96	70						1 987 470 487 ⁷	
55 2.4	ABO	08.85-07.86	62						1 987 470 487 ⁷	
									1 987 470 487 ⁷	
									1 987 470 487 ⁷	
	ABS	07.89-07.92	66						1 987 470 487 ⁷	
55 2.4 D	ABO	08.85-04.96	51/55						1 987 470 487 ⁷	
									1 987 470 487 ⁷	
	ABS	07.89-04.96	51/55						1 987 470 487 ⁷	
55 2.4 D Turbo	ABO	08.85-04.96	70/75						1 987 470 487 ⁷	
									1 987 470 487 ⁷	
	ABS	07.89-04.96	70/75						1 987 470 487 ⁷	





◀ VW LT [28, 29, 21]



	28 2.4	10.88-11.90	70	Fg.Nr. →29-M-009 906		0 986 475 475	↔ 25,4
		10.88-04.96	70		ZWB	0 986 475 614	↔ 26,99
		11.90-07.92	66	Fg.Nr. 29-M-009 907→		0 986 475 476	↔ 25,4
		11.90-04.96	70	Fg.Nr. 29-M-009 907→		0 986 475 476	↔ 25,4
	28 2.4 D	08.89-11.90	51	Fg.Nr. →29-M-009 906		0 986 475 475	↔ 25,4
		08.89-07.92	51		ZWB	0 986 475 614	↔ 26,99
		11.90-07.92	51	Fg.Nr. 29-M-009 907→		0 986 475 476	↔ 25,4
			55	Fg.Nr. 29-M-009 907→		0 986 475 476	↔ 25,4
	28 2.4 D Turbo	08.92-04.96	51			0 986 475 476	↔ 25,4
		08.88-11.90	68	Fg.Nr. →29-M-009 906		0 986 475 475	↔ 25,4
		11.90-08.92	66/75	Fg.Nr. 29-M-009 907→		0 986 475 476	↔ 25,4
			68	Fg.Nr. 29-M-009 907→		0 986 475 476	↔ 25,4
	31 2.4	09.92-04.96	70			0 986 475 476	↔ 25,4
		10.88-11.90	70	Fg.Nr. →29-M-009 906		0 986 475 475	↔ 25,4
		10.88-04.96	70		ZWB	0 986 475 614	↔ 26,99
		11.90-04.96	70	Fg.Nr. 29-M-009 907→		0 986 475 476	↔ 25,4
	31 2.4 D	08.89-11.90	51	Fg.Nr. →29-M-009 906		0 986 475 475	↔ 25,4
		08.89-07.92	51		ZWB	0 986 475 614	↔ 26,99
		11.90-07.92	51	Fg.Nr. 29-M-009 907→		0 986 475 476	↔ 25,4
			55	Fg.Nr. 29-M-009 907→		0 986 475 476	↔ 25,4
	31 2.4 D Turbo	08.92-04.96	51			0 986 475 476	↔ 25,4
		08.88-11.90	68	Fg.Nr. →29-M-009 906		0 986 475 475	↔ 25,4
		08.88-08.92	68		ZWB	0 986 475 614	↔ 26,99
		11.90-08.92	68	Fg.Nr. 29-M-009 907→		0 986 475 476	↔ 25,4
	31 2.4, 2.4 D Turbo	09.92-04.96	70			0 986 475 476	↔ 25,4
		11.90-08.92	66/75	Fg.Nr. 29-M-009 907→		0 986 475 476	↔ 25,4
		10.88-11.90	70	Fg.Nr. →29-M-009 906		0 986 475 475	↔ 25,4
		10.88-04.96	70		ZWB	0 986 475 614	↔ 26,99
	35 2.4	11.90-04.96	70	Fg.Nr. 29-M-009 907→		0 986 475 476	↔ 25,4
		08.89-11.90	51	Fg.Nr. →29-M-009 906		0 986 475 475	↔ 25,4
		08.89-07.92	51		ZWB	0 986 475 614	↔ 26,99
		11.90-07.92	51	Fg.Nr. 29-M-009 907→		0 986 475 476	↔ 25,4
	35 2.4 D		55	Fg.Nr. 29-M-009 907→		0 986 475 476	↔ 25,4
		08.92-04.96	51			0 986 475 476	↔ 25,4
		08.88-11.90	68	Fg.Nr. →29-M-009 906		0 986 475 475	↔ 25,4
		08.88-08.92	68		ZWB	0 986 475 614	↔ 26,99
	35 2.4 D Turbo	11.90-08.92	68	Fg.Nr. 29-M-009 907→		0 986 475 476	↔ 25,4
		09.92-04.96	70			0 986 475 476	↔ 25,4
		11.90-08.92	68	Fg.Nr. 29-M-009 907→		0 986 475 476	↔ 25,4
		09.92-04.96	70			0 986 475 476	↔ 25,4
	35 2.4, 2.4 D Turbo	11.90-08.92	66/75	Fg.Nr. 29-M-009 907→		0 986 475 476	↔ 25,4
		10.88-11.90	70	Fg.Nr. →29-M-009 906		0 986 475 475	↔ 25,4
		10.88-04.96	70		ZWB	0 986 475 614	↔ 26,99
		11.90-04.96	70	Fg.Nr. 29-M-009 907→		0 986 475 476	↔ 25,4
	40 2.4	08.89-11.90	51	Fg.Nr. →29-M-009 906		0 986 475 475	↔ 25,4
		08.89-07.92	51		ZWB	0 986 475 614	↔ 26,99
		11.90-07.92	51	Fg.Nr. 29-M-009 907→		0 986 475 476	↔ 25,4
			55	Fg.Nr. 29-M-009 907→		0 986 475 476	↔ 25,4
	40 2.4 D	08.92-04.96	51			0 986 475 476	↔ 25,4
		08.88-11.90	68	Fg.Nr. →29-M-009 906		0 986 475 475	↔ 25,4
		08.88-08.92	68		ZWB	0 986 475 614	↔ 26,99
		11.90-08.92	68	Fg.Nr. 29-M-009 907→		0 986 475 476	↔ 25,4
	40 2.4 D Turbo	09.92-04.96	70			0 986 475 476	↔ 25,4
		11.90-08.92	66/75	Fg.Nr. 29-M-009 907→		0 986 475 476	↔ 25,4
		11.90-07.92	55	Fg.Nr. 29-M-009 907→		0 986 475 476	↔ 25,4
		08.92-04.96	51			0 986 475 476	↔ 25,4
	45 2.4 D Turbo	09.92-04.96	70			0 986 475 476	↔ 25,4
		11.90-08.92	66/75	Fg.Nr. 29-M-009 907→		0 986 475 476	↔ 25,4
		11.90-07.92	66/75	Fg.Nr. 29-M-009 907→		0 986 475 476	↔ 25,4
		11.90-07.92	55	Fg.Nr. 29-M-009 907→		0 986 475 476	↔ 25,4
	50 2.4	08.92-04.96	51			0 986 475 476	↔ 25,4
		09.92-04.96	70			0 986 475 476	↔ 25,4
		11.90-08.92	66/75	Fg.Nr. 29-M-009 907→		0 986 475 476	↔ 25,4
		11.90-07.92	66/75	Fg.Nr. 29-M-009 907→		0 986 475 476	↔ 25,4
	50 2.4 D	11.90-07.92	55	Fg.Nr. 29-M-009 907→		0 986 475 476	↔ 25,4
		08.92-04.96	51			0 986 475 476	↔ 25,4



		S							
50 2.4 D Turbo		11.90-08.92	75	Fg.Nr. 29-M-009 907→			0 986 475 476	↔ 25,4	
		09.92-04.96	70				0 986 475 476	↔ 25,4	
55 2.4		08.85-07.86	62		ZWB		0 986 475 614	↔ 26,99	
				Fg.Nr. →29-M-009 906			0 986 475 475	↔ 25,4	
		08.85-11.90	66	Fg.Nr. →29-M-009 906			0 986 475 475	↔ 25,4	
		08.85-07.92	66		ZWB		0 986 475 614	↔ 26,99	
		11.90-07.92	66	Fg.Nr. 29-M-009 907→			0 986 475 476	↔ 25,4	
55 2.4 D		08.85-11.90	55	Fg.Nr. →29-M-009 906			0 986 475 475	↔ 25,4	
		08.85-07.92	55		ZWB		0 986 475 614	↔ 26,99	
		11.90-07.92	55	Fg.Nr. 29-M-009 907→			0 986 475 476	↔ 25,4	
		08.92-04.96	51				0 986 475 476	↔ 25,4	
55 2.4 D Turbo		08.85-11.90	75	Fg.Nr. →29-M-009 906			0 986 475 475	↔ 25,4	
		08.85-08.92	75		ZWB		0 986 475 614	↔ 26,99	
		11.90-08.92	75	Fg.Nr. 29-M-009 907→			0 986 475 476	↔ 25,4	
		09.92-04.96	70				0 986 475 476	↔ 25,4	

28 2.4, 2.4 D, 2.4 D Turbo			08.88-04.96	51/68/70			0 986 480 079	23,8	1 987 472 178
31 2.4, 2.4 D, 2.4 D Turbo									
35 2.4, 2.4 D, 2.4 D Turbo									
40 2.4, 2.4 D, 2.4 D Turbo									
45 2.4 D, 2.4 D Turbo									
50 2.4 D, 2.4 D Turbo									
55 2.4 D, 2.4 D Turbo									

28 2.4, 2.4 D, 2.4 D Turbo		08.85-04.96	51/55/62/			0 986 485 103			
31 2.4, 2.4 D, 2.4 D Turbo			66/68/70/						
35 2.4, 2.4 D, 2.4 D Turbo			75						
40 2.4, 2.4 D, 2.4 D Turbo									
55 2.4, 2.4 D, 2.4 D Turbo									

28 2.4, 2.4 D, 2.4 D Turbo		08.89-04.96	51/55/66/			0 265 103 059 ¹⁶			
31 2.4, 2.4 D, 2.4 D Turbo			68/70/75		FLR	0 265 100 069 ¹⁶			
35 2.4, 2.4 D, 2.4 D Turbo									
40 2.4, 2.4 D, 2.4 D Turbo									
45 2.4, 2.4 D, 2.4 D Turbo									
50 2.4, 2.4 D, 2.4 D Turbo									
55 2.4, 2.4 D, 2.4 D Turbo									

LT [29, 21]

40 2.4 D Turbo 4x4, 2.4 D 4x4			09.85-08.92	55/66/75			1 987 476 380	297	
40 2.4 4x4						BMS	1 987 476 139	440	
45 2.4 D Turbo 4x4, 2.4 D 4x4									
45 2.4 4x4									

40 2.4 D Turbo 4x4, 2.4 D 4x4			09.85-08.92	55/66/75			0 986 475 476	↔ 25,4	
40 2.4 4x4									
45 2.4 D Turbo 4x4, 2.4 D 4x4									
45 2.4 4x4									

40 2.4 D Turbo 4x4, 2.4 D 4x4			09.85-08.92	55/66/75			0 986 480 079	23,8	1 987 472 178
40 2.4 4x4									
45 2.4 D Turbo 4x4, 2.4 D 4x4									
45 2.4 4x4									



◀ VW LT [29, 21]

	40 2.4 D Turbo 4x4, 2.4 D 4x4	09.85-08.92	55/66/75		0986 485 103		
	40 2.4 4x4						
	45 2.4 D Turbo 4x4, 2.4 D 4x4						
	45 2.4 4x4						

Microbus



	2.1 i	11.85-12.88	82	FSB,GIR	0986 471 668	← 60	1987 470 048 ⁷
					0986 473 668		
					0986 472 668	→ 60	1987 470 048 ⁷
					0986 474 668		



	2.1 i	11.85-12.91	82		F 026 002 305	↔ 23,8	
--	-------	-------------	----	--	---------------	--------	--



	2.1 i	11.85-12.91	82	FBM	0 204 123 029	23,8	1987 472 294
--	-------	-------------	----	-----	---------------	------	--------------























































	2.1 i	11.85-12.91	82		0986 485 103		
--	-------	-------------	----	--	--------------	--	--

Multivan T4 [70, 7D]



	1.8	12.90-07.92	49	MVB	1987 476 411	330	
		09.90-12.95	45	MVB	1987 476 411	330	
	1.9 D	01.96-04.97	45	MVB	1987 476 698	375	
		10.92-12.95	50	MVB	1987 476 411	330	
	1.9 D Turbo	01.96-04.98	50	MVB	1987 476 698	375	
		05.98-06.03	50	MVB	1987 476 698	375	
		09.90-12.95	62	MVB	1987 476 411	330	
	2.0	01.96-04.98	62	MVB	1987 476 698	375	
		05.98-06.03	62	MVB	1987 476 698	375	
		09.90-12.95	57	MVB	1987 476 411	330	
	2.4 D	01.96-04.98	57	MVB	1987 476 698	375	
		05.97-04.98	55	MVB	1987 476 698	375	
		05.98-05.98	57	MVB	1987 476 698	375	
		05.98-06.03	55	MVB	1987 476 698	375	
		11.92-12.95	57	MVB	1987 476 411	330	
	2.4 D Syncro	01.96-04.98	57	MVB	1987 476 698	375	
		05.98-09.98	57	MVB	1987 476 698	375	
		11.90-12.93	81	MVB	1987 476 411	330	
	2.5	07.94-12.95	81	MVB	1987 476 411	330	
		01.96-10.96	81	MVB	1987 476 698	375	
08.96-04.98		81	MVB	1987 476 698	375		
		85	MVB	1987 476 698	375		
05.98-06.03		81	MVB	1987 476 698	375		
		85	MVB	1987 476 698	375		
			MVB	1987 476 698	375		

		S												
2.5 Syncro	11.92-12.95	81				MVB	1 987 476 411	330						
	01.96-10.96	81				MVB	1 987 476 698	375						
	08.96-04.98	85				MVB	1 987 476 698	375						
	06.97-04.98	81				MVB	1 987 476 698	375						
	05.98-11.01	81				MVB	1 987 476 698	375						
	05.98-06.03	85				MVB	1 987 476 698	375						
	05.99-06.03	85				MVB	1 987 476 698	375						
2.5 TDI	01.95-12.95	75				MVB	1 987 476 411	330						
	01.96-04.98	75				MVB	1 987 476 698	375						
	05.98-06.03	65				MVB	1 987 476 698	375						
		75				MVB	1 987 476 698	375						
		111				MVB	1 987 476 698	375						
04.01-06.03	75				MVB	1 987 476 698	375							
2.5 TDI Syncro	03.98-04.98	75				MVB	1 987 476 698	375						
	05.98-06.03	75				MVB	1 987 476 698	375						
2.8	01.96-04.98	103				MVB	1 987 476 698	375						
	05.98-05.00	103				MVB	1 987 476 698	375						
	05.00-06.03	150				MVB	1 987 476 698	375						
	1.8	09.90-04.98	45/49/50/	PR-Nr. 1LP	281		0 986 473 177	 ← 53,93						
	1.9 D		55/57/62				0 986 474 177	 → 53,93						
	1.9 D Turbo	09.90-06.03	45/49/50/	PR-Nr. 1LA	266		0 986 473 703	 ← 54						
	2.0		55/57/62				0 986 474 703	 → 54						
	2.4 D			PR-Nr. 1LB	1KX		0 986 473 184	 ← 57						
	2.4 D Syncro							0 986 474 184	 → 57					
						326		0 986 473 178	 ← 56,96	1 987 470 005 ⁷				
								0 986 474 178	 → 56,96	1 987 470 005 ⁷				
				PR-Nr. 1LE	284	LUC	0 986 473 806	 ← 54						
								0 986 473 807	 → 54					
				PR-Nr. 1LU	284	ATE	0 986 473 361	 ← 56,93	1 987 470 005 ⁷					
								0 986 473 361	 ← 56,93	1 987 470 506 ⁸				
								0 986 474 361	 → 56,93	1 987 470 506 ⁸				
	2.5	11.90-12.93	81		PR-Nr. 1LA	266		0 986 473 703	 ← 54					
								0 986 474 703	 → 54					
								PR-Nr. 1LB	1KX	0 986 473 184	 ← 57			
										0 986 474 184	 → 57			
326									0 986 473 178	 ← 56,96	1 987 470 005 ⁷			
									0 986 474 178	 → 56,96	1 987 470 005 ⁷			
PR-Nr. 1LE								284	LUC	0 986 473 806	 ← 54			
										0 986 473 807	 → 54			
PR-Nr. 1LP								281		0 986 473 177	 ← 53,93			
										0 986 474 177	 → 53,93			
PR-Nr. 1LU		284	ATE	0 986 473 361	 ← 56,93	1 987 470 005 ⁷								
				0 986 473 361	 ← 56,93	1 987 470 506 ⁸								
				0 986 474 361	 → 56,93	1 987 470 506 ⁸								
07.94-10.96		81		PR-Nr. 1LA	266		0 986 473 703	 ← 54						
							PR-Nr. 1LB	326	0 986 473 178	 ← 56,96	1 987 470 005 ⁷			
									0 986 474 177	 → 53,93				
							PR-Nr. 1LP	281		0 986 473 177	 ← 53,93			
										0 986 474 177	 → 53,93			
							PR-Nr. 1LU	284	ATE	0 986 473 361	 ← 56,93	1 987 470 506 ⁸		
										0 986 474 361	 → 56,93	1 987 470 506 ⁸		
	07.94-04.98						81		PR-Nr. 1LP	281		0 986 473 177	 ← 53,93	
												0 986 474 703	 → 54	
	07.94-06.03						81		PR-Nr. 1LA	266		0 986 473 184	 ← 57	
0 986 474 184		 → 57												
						0 986 473 178	 ← 56,96	1 987 470 005 ⁷						
						0 986 474 178	 → 56,96	1 987 470 005 ⁷						
PR-Nr. 1LE	284	LUC	0 986 473 806	 ← 54										
			0 986 473 807	 → 54										
PR-Nr. 1LU	284	ATE	0 986 473 361	 ← 56,93	1 987 470 005 ⁷									
			0 986 473 361	 ← 56,93	1 987 470 506 ⁸									
			0 986 474 361	 → 56,93	1 987 470 506 ⁸									



		S								
◀ VW Multivan T4 [70, 7D]										
2.5	09.95-12.95	81	PR-Nr. 1LA	266			0986 473 703		← 54	
						0986 474 703		→ 54		
			PR-Nr. 1LU	284	ATE		0986 474 361		→ 56,93 1987 470 005 ⁷	
	08.96-04.98	81	PR-Nr. 1LP	281			0986 474 177		→ 53,93	
	08.96-06.03	81	PR-Nr. 1LA	266			0986 473 703		← 54	
2.5	08.96-04.98	85	PR-Nr. 1LP	281			0986 473 177		← 53,93	
2.5 Syncro	08.96-06.03	85	PR-Nr. 1LA	266			0986 473 703		← 54	
						0986 474 703		→ 54		
			PR-Nr. 1LB	1KX			0986 473 184		← 57	
				326			0986 474 184		→ 57	
				326			0986 473 178		← 56,96 1987 470 005 ⁷	
				326			0986 474 178		→ 56,96 1987 470 005 ⁷	
			PR-Nr. 1LE	284	LUC		0986 473 806		← 54	
							0986 473 807		→ 54	
			PR-Nr. 1LU	284	ATE		0986 473 361		← 56,93 1987 470 005 ⁷	
							0986 473 361		← 56,93 1987 470 506 ⁸	
							0986 474 361		→ 56,93 1987 470 506 ⁸	
2.5 Syncro	11.92-12.93	81	PR-Nr. 1LA	266			0986 473 703		← 54	
						0986 473 361		← 56,93 1987 470 005 ⁷		
			PR-Nr. 1LU	284	ATE		0986 473 361		← 56,93 1987 470 506 ⁸	
							0986 474 361		→ 56,93 1987 470 005 ⁷	
	11.92-10.96	81	PR-Nr. 1LA	266			0986 474 703		→ 54	
					0986 473 184		← 57			
			PR-Nr. 1LB	1KX			0986 474 184		→ 57	
				326			0986 473 178		← 56,96 1987 470 005 ⁷	
				326			0986 474 178		→ 56,96 1987 470 005 ⁷	
			PR-Nr. 1LE	284	LUC		0986 473 806		← 54	
							0986 473 807		→ 54	
			PR-Nr. 1LP	281			0986 473 177		← 53,93	
							0986 474 177		→ 53,93	
			PR-Nr. 1LU	284	ATE		0986 473 361		← 56,93 1987 470 005 ⁷	
	01.94-10.96	81	PR-Nr. 1LA	266			0986 473 703		← 54	
				PR-Nr. 1LB	326			0986 473 178		← 56,96 1987 470 005 ⁷
				PR-Nr. 1LU	284	ATE		0986 473 361		← 56,93 1987 470 506 ⁸
							0986 474 361		→ 56,93 1987 470 506 ⁸	
	06.97-04.98	81	PR-Nr. 1LP	281			0986 473 177		← 53,93	
							0986 474 177		→ 53,93	
	06.97-11.01	81	PR-Nr. 1LA	266			0986 473 703		← 54	
							0986 474 703		→ 54	
			PR-Nr. 1LB	1KX			0986 473 184		← 57	
				326			0986 474 184		→ 57	
				326			0986 473 178		← 56,96 1987 470 005 ⁷	
				326			0986 474 178		→ 56,96 1987 470 005 ⁷	
			PR-Nr. 1LE	284	LUC		0986 473 806		← 54	
							0986 473 807		→ 54	
			PR-Nr. 1LU	284	ATE		0986 473 361		← 56,93 1987 470 005 ⁷	
							0986 473 361		← 56,93 1987 470 506 ⁸	
							0986 474 361		→ 56,93 1987 470 506 ⁸	
2.5 TDI	01.95-04.98	75	PR-Nr. 1LP	281			0986 473 177		← 53,93	
						0986 474 177		→ 53,93		
	01.95-06.03	75	PR-Nr. 1LA	266			0986 473 703		← 54	
							0986 474 703		→ 54	
			PR-Nr. 1LB	1KX			0986 473 184		← 57	
				326			0986 474 184		→ 57	
				326			0986 473 178		← 56,96 1987 470 005 ⁷	
				326			0986 474 178		→ 56,96 1987 470 005 ⁷	
			PR-Nr. 1LE	284	LUC		0986 473 806		← 54	
							0986 473 807		→ 54	
			PR-Nr. 1LU	284	ATE		0986 473 361		← 56,93 1987 470 005 ⁷	
							0986 473 361		← 56,93 1987 470 506 ⁸	
							0986 474 361		→ 56,93 1987 470 506 ⁸	



		S										
2.5 TDI	05.98-06.03	65	PR-Nr. 1LA	266			0 986 473 703		54			
							0 986 474 703		54			
			PR-Nr. 1LB	1KX			0 986 473 184		57			
							0 986 474 184		57			
				326			0 986 473 178		56,96	1 987 470 005 ⁷		
							0 986 474 178		56,96	1 987 470 005 ⁷		
	111	03.98-04.98	75/103	PR-Nr. 1LE	284	LUC		0 986 473 806		54		
								0 986 473 807		54		
				PR-Nr. 1LU	284	ATE		0 986 473 361		56,93	1 987 470 005 ⁷	
								0 986 473 361		56,93	1 987 470 506 ⁸	
								0 986 474 361		56,93	1 987 470 506 ⁸	
								0 986 474 361		56,93	1 987 470 506 ⁸	
	2.5 TDI Syncro	03.98-06.03	75/103	PR-Nr. 1LA	266			0 986 473 703		54		
								0 986 474 703		54		
				PR-Nr. 1LB	1KX			0 986 473 184		57		
								0 986 474 184		57		
					326			0 986 473 178		56,96	1 987 470 005 ⁷	
								0 986 474 178		56,96	1 987 470 005 ⁷	
03.98-04.98		75/103	75/103	PR-Nr. 1LE	284	LUC		0 986 473 806		54		
								0 986 473 807		54		
				PR-Nr. 1LU	284	ATE		0 986 473 361		56,93	1 987 470 005 ⁷	
								0 986 473 361		56,93	1 987 470 506 ⁸	
								0 986 474 361		56,93	1 987 470 506 ⁸	
								0 986 474 361		56,93	1 987 470 506 ⁸	
2.8		01.96-04.98	75/103	PR-Nr. 1LP	281			0 986 473 177		53,93		
								0 986 474 177		53,93		
				01.96-05.00	75/103	PR-Nr. 1LA	266			0 986 473 703		54
										0 986 474 703		54
						PR-Nr. 1LB	1KX			0 986 473 184		57
										0 986 474 184		57
		326					0 986 473 178		56,96	1 987 470 005 ⁷		
							0 986 474 178		56,96	1 987 470 005 ⁷		
	05.00-06.03	150	150	PR-Nr. 1LE	284	LUC		0 986 473 806		54		
								0 986 473 807		54		
				PR-Nr. 1LU	284	ATE		0 986 473 361		56,93	1 987 470 005 ⁷	
								0 986 473 361		56,93	1 987 470 506 ⁸	
								0 986 474 361		56,93	1 987 470 506 ⁸	
								0 986 474 361		56,93	1 987 470 506 ⁸	





◀ VW Multivan T4 [70, 7D]















	1.8	09.90-06.03	45/49/50/		SSZ	1987 476 220	160
	1.9 D, D Turbo		55/57/62/				
	2.0		65/75/81/				
	2.4 D, D Syncro		85/111				
	2.5, Syncro, TDI						
	2.5 TDI Syncro	03.98-06.03	75		SSZ	1987 476 220	160
		04.01-06.03	75			1987 476 220 ¹	160
						1987 476 230 ²	160
	2.8	01.96-06.03	103/150		SSZ	1987 476 220	160

	1.8	09.90-06.03	45/49/50/			0986 475 935	↔ 20,64
	1.9 D, D Turbo		55/57/62/				
	2.0		65/75/81/				
	2.4 D, D Syncro		85/103/				
	2.5, Syncro, TDI, TDI Syncro		111/150				
	2.8						



	1.8	ABO, 12.90-07.92	49			F 026 003 563	22
		OFD					
		ABS, 12.90-07.92	49			0986 480 834	22,19
	1.9 D	ABO, 06.95-06.03	45/50/62	Fg.Nr. 70..S..127 806→		0986 480 930	23,8
	1.9 D Turbo	ABO, 09.90-05.95	45/50/62	Fg.Nr. →70..S..127 805		F 026 003 563	22
		OFD					
		ABS, 09.90-05.95	45/50/62	Fg.Nr. →70..S..127 805		0986 480 834	22,19
		ABS, 06.95-06.03	45/50/62	Fg.Nr. 70..S..127 806→		0986 480 933	23,8
		OFD					
	2.0	ABO, 06.95-06.03	45/50/62	Fg.Nr. 70..S..127 806→		0986 480 930	23,8
		ABO, 09.90-05.95	45/50/62	Fg.Nr. →70..S..127 805		F 026 003 563	22
		OFD					
		ABS, 09.90-05.95	45/50/62	Fg.Nr. →70..S..127 805		0986 480 834	22,19
		ABS, 06.95-06.03	45/50/62	Fg.Nr. 70..S..127 806→		0986 480 933	23,8
		OFD					
2.4 D	ABO, 05.97-06.03	55			0986 480 930	23,8	
	ABS, 05.97-06.03	55			0986 480 933	23,8	
	OFD						
2.4 D	ABO, 06.95-09.98	57	Fg.Nr. 70..S..127 806→		0986 480 930	23,8	
2.4 D Syncro	ABO, 09.90-05.95	57	Fg.Nr. →70..S..127 805		F 026 003 563	22	
	OFD						
	ABS, 09.90-05.95	57	Fg.Nr. →70..S..127 805		0986 480 834	22,19	
	ABS, 06.95-09.98	57	Fg.Nr. 70..S..127 806→		0986 480 933	23,8	
	OFD						
2.5	ABO, 06.95-10.96	81	Fg.Nr. 70..S..127 806→		0986 480 930	23,8	
	09.95-12.95	81			0986 480 930	23,8	
	08.96-06.03	81			0986 480 933	23,8	
	ABS, 06.95-10.96	81	Fg.Nr. 70..S..127 806→		0986 480 933	23,8	
	OFD, 09.95-12.95	81			0986 480 933	23,8	
	08.96-06.03	81			0986 480 933	23,8	
2.5	ABO, 08.96-06.03	85			0986 480 930	23,8	
2.5 Syncro	ABO, 11.90-12.93	81			F 026 003 563	22	
	OFD, 01.94-05.95	81	Fg.Nr. →70..S..127 805		F 026 003 563	22	
	ABS, 11.90-12.93	81			0986 480 834	22,19	
	01.94-05.95	81	Fg.Nr. →70..S..127 805		0986 480 834	22,19	
	ABS, 08.96-06.03	85			0986 480 933	23,8	
	OFD						
2.5 Syncro	ABO, 06.95-10.96	81	Fg.Nr. 70..S..127 806→		0986 480 930	23,8	
	06.97-11.01	81			0986 480 930	23,8	
	ABS, 06.95-10.96	81	Fg.Nr. 70..S..127 806→		0986 480 933	23,8	
	OFD, 06.97-11.01	81			0986 480 933	23,8	

		S							
2.5 TDI	ABO	06.95-06.03	75	Fg.Nr. 70..S..127 806→			0 986 480 930	23,8	
		05.98-06.03	65				0 986 480 930	23,8	
			111				0 986 480 930	23,8	
		05.99-06.03	75				0 986 480 930	23,8	
	ABO,	01.95-05.95	75	Fg.Nr. →70..S..127 805			F 026 003 563	22	
	OFD								
	ABS	01.95-05.95	75	Fg.Nr. →70..S..127 805			0 986 480 834	22,19	
	ABS,	06.95-06.03	75	Fg.Nr. 70..S..127 806→			0 986 480 933	23,8	
	OFD	05.98-06.03	65				0 986 480 933	23,8	
			111				0 986 480 933	23,8	
	05.99-06.03	75				0 986 480 933	23,8		
2.5 TDI Syncro	ABO	03.98-06.03	75				0 986 480 930	23,8	
	ABS	04.01-06.03	75				0 986 480 933	23,8	
	ABS,	03.98-06.03	75				0 986 480 933	23,8	
	OFD								
2.8	ABO	01.96-06.03	103/150				0 986 480 930	23,8	
	ABS,	01.96-06.03	103/150				0 986 480 933	23,8	
	OFD								
	1.8	OFD	12.90-07.92	49			0 986 485 112		
	1.9D, D Turbo	OFD	09.90-05.95	45/50/57/	Fg.Nr. →70..S..127 805		0 986 485 112		
	2.0			62					
	2.4D, D Syncro								
	2.5	OFD	11.90-12.93	81			0 986 485 112		
	2.5 Syncro		01.94-05.95	81	Fg.Nr. →70..S..127 805		0 986 485 112		
	2.5 TDI	OFD	01.95-05.95	75	Fg.Nr. →70..S..127 805		0 986 485 112		
	1.8		09.90-06.03	45/49/50/		TW	0 986 486 037		
	1.9D, D Turbo			55/57/62/			0 986 486 048		
	2.0			65/75/81/					
	2.4D, D Syncro			85/111					
	2.5, Syncro, TDI								
	2.5 TDI Syncro		03.98-06.03	75			TW	0 986 486 037	
								0 986 486 048	
		04.01-06.03	75				0 986 486 048		
2.8		01.96-06.03	103/150			TW	0 986 486 037		
							0 986 486 048		
	1.8		09.90-04.97	45/49			0 986 486 537		
	1.9D								
	1.9D Turbo		09.90-04.97	50/62			0 986 486 537		
	2.0		05.97-06.03	50/62			0 986 486 538		
	2.4D		05.97-06.03	55			0 986 486 538		
	2.4D, D Syncro		09.90-04.97	57/81/85			0 986 486 537		
	2.5, Syncro		05.97-06.03	57/81/85			0 986 486 538		
	2.5 TDI		05.98-06.03	65/150			0 986 486 538		
	2.8								
	1.8		09.90-06.03	45/49/50/			0 204 031 292 ¹⁰		
	1.9D, D Turbo			55/57/62/					
	2.0			65/75/81/					
	2.4D, D Syncro			85/103/					
	2.5, Syncro, TDI, TDI Syncro			111/150					
2.8									
	1.8		12.90-07.92	49			1 987 477 171	↔ 854	
	1.9D, D Turbo		09.90-02.97	45/50/62	Fg.Nr. →70..V..120 000	SBR	1 987 477 706	↔ 938	
	2.0		09.90-06.03	45/50/62		TBR	1 987 477 171	↔ 854	
			03.97-06.03	45/50/62	Fg.Nr. 70..V..120 001→	SBR	1 987 477 707	↔ 948	











◀ VW Multivan T4 [70, 7D]

2.4D	09.90-02.97	57	Fg.Nr. →70..V..120 000	SBR	1987 477 706	↔ 938	
	09.90-05.98	57		TBR	1987 477 171	↔ 854	
	03.97-05.98	57	Fg.Nr. 70..V..120 001→	SBR	1987 477 707	↔ 948	
	05.97-06.03	55		TBR	1987 477 707	↔ 948	
2.4D Syncro	11.92-04.97	57		SBR	1987 477 706	↔ 938	
	11.92-09.98	57		TBR	1987 477 171	↔ 854	
	05.97-09.98	57		SBR	1987 477 707	↔ 948	
2.5	11.90-12.93	81			1987 477 171	↔ 854	
	07.94-10.96	81		SBR	1987 477 706	↔ 938	
	07.94-06.03	81		TBR	1987 477 171	↔ 854	
	09.95-12.95	81			1987 477 171	↔ 854	
	08.96-02.97	81	Fg.Nr. →70..V..120 000	SBR	1987 477 706	↔ 938	
		85	Fg.Nr. →70..V..120 000	SBR	1987 477 706	↔ 938	
	08.96-06.03	85		TBR	1987 477 171	↔ 854	
	03.97-06.03	81	Fg.Nr. 70..V..120 001→	SBR	1987 477 707	↔ 948	
		85	Fg.Nr. 70..V..120 001→	SBR	1987 477 707	↔ 948	
	05.99-06.03	85		SBR	1987 477 707	↔ 948	
	2.5 Syncro	11.92-04.97	81/85		SBR	1987 477 706	↔ 938
		11.92-06.03	81/85		TBR	1987 477 171	↔ 854
05.97-06.03		81/85		SBR	1987 477 707	↔ 948	
2.5 TDI	01.95-02.97	75	Fg.Nr. →70..V..120 000	SBR	1987 477 706	↔ 938	
	01.95-06.03	75		TBR	1987 477 171	↔ 854	
	03.97-06.03	75	Fg.Nr. 70..V..120 001→	SBR	1987 477 707	↔ 948	
	05.98-06.03	65		SBR	1987 477 707	↔ 948	
		111		TBR	1987 477 171	↔ 854	
		111		TBR	1987 477 171	↔ 854	
2.5 TDI Syncro	05.99-06.03	75		SBR	1987 477 707	↔ 948	
	03.98-06.03	75		SBR	1987 477 707	↔ 948	
				TBR	1987 477 171	↔ 854	
	04.01-06.03	75			1987 477 706	↔ 938	
2.8	01.96-02.97	103	Fg.Nr. →70..V..120 000	SBR	1987 477 706	↔ 938	
	01.96-05.00	103		TBR	1987 477 171	↔ 854	
	03.97-05.00	103	Fg.Nr. 70..V..120 001→	SBR	1987 477 707	↔ 948	
	05.00-06.03	150		SBR	1987 477 707	↔ 948	
				TBR	1987 477 171	↔ 854	

	1.8	12.90-07.92	49		0 265 202 454 ²⁰
	1.9 D, D Turbo	09.90-06.03	45/50/55/57/62/65/75/81/85/111		0 265 202 454 ²⁰
	2.0	01.96-06.03	45/50/55/57/62/65/		0 265 220 434 ¹⁴
	2.4 D, D Syncro		75/81/85/111		
	2.5, Syncro, TDI, TDI Syncro				
2.8	01.96-05.00	103			0 265 202 454 ²⁰
	10.97-05.00	103	Fg.Nr. 70..W..062 420→		0 265 220 434 ¹⁴
	05.00-06.03	150			0 265 202 454 ²⁰
					0 265 220 434 ¹⁴

	1.8	09.90-12.95	45/49/50/62		0 265 100 072 ¹⁶	
	1.9 D, D Turbo	09.90-06.03	45/49/50/	1KX,326	0 265 109 612 ²⁰	
	2.0		62	281,284,GRG	0 265 109 602 ²⁰	
	2.4 D	05.97-06.03	55		1KX,326	0 265 109 612 ²⁰
					281,284,GRG	0 265 109 602 ²⁰
	2.4 D	09.90-12.95	57/81			0 265 100 072 ¹⁶
	2.4 D Syncro	09.90-06.03	57/81		1KX,326	0 265 109 612 ²⁰
	2.5	08.96-06.03	85		281,284,GRG	0 265 109 602 ²⁰
					1KX,326	0 265 109 612 ²⁰
	2.5 Syncro	11.92-12.95	81			0 265 100 072 ¹⁶
		11.92-10.96	81		1KX,326	0 265 109 612 ²⁰
					281,284,GRG	0 265 109 602 ²⁰
		06.97-11.01	81		1KX,326	0 265 109 612 ²⁰
					281,284,GRG	0 265 109 602 ²⁰

		S							
2.5 Syncro		08.96-06.03	65/85			1KX,326	0 265 109 612 ²⁰		
2.5 TDI						281,284,GRG	0 265 109 602 ²⁰		
2.5 TDI		01.95-12.95	75				0 265 100 072 ¹⁶		
		01.95-06.03	75			1KX,326	0 265 109 612 ²⁰		
						281,284,GRG	0 265 109 602 ²⁰		
		05.98-06.03	111			1KX,326	0 265 109 612 ²⁰		
						281,284,GRG	0 265 109 602 ²⁰		
2.5 TDI Syncro		03.98-06.03	75			1KX,326	0 265 109 612 ²⁰		
						281,284,GRG	0 265 109 602 ²⁰		
		04.01-05.02	75	Fg.Nr. →70..3..019 101		GRG	0 265 109 602 ²⁰		
		06.02-06.03	75	Fg.Nr. 70..3..019 102→			0 265 109 612 ²⁰		
2.8		01.96-06.03	103/150			1KX,326	0 265 109 612 ²⁰		
						281,284,GRG	0 265 109 602 ²⁰		
 1.8		12.90-07.92	49				0 265 006 407 ³		
						LAB,MVB	0 265 006 508 ⁴		
						MVB,RAB	0 265 006 510 ⁴		
						MVB	0 986 594 013 ⁴		
1.9 D		09.90-12.95	45/50/62	Fg.Nr. →70..T..199 000		MVB	0 986 594 013 ⁴		
1.9 D Turbo		09.90-06.03	45/50/62				0 265 006 407 ³		
2.0						LAB,MVB	0 265 006 508 ⁴		
						MVB,RAB	0 265 006 510 ⁴		
		01.96-06.03	45/50/62	Fg.Nr. 70..T..200 001→		LAB,MVB	0 265 006 408 ⁴		
						MVB,RAB	0 265 006 409 ⁴		
2.4 D		05.97-06.03	55				0 265 006 407 ³		
						LAB,MVB	0 265 006 508 ⁴		
						LAB,MVB	0 265 006 408 ⁴		
						MVB,RAB	0 265 006 510 ⁴		
						MVB,RAB	0 265 006 409 ⁴		
2.4 D		09.90-12.95	57	Fg.Nr. →70..T..199 000		MVB	0 986 594 013 ⁴		
2.4 D Syncro		09.90-09.98	57				0 265 006 407 ³		
						LAB,MVB	0 265 006 508 ⁴		
						MVB,RAB	0 265 006 510 ⁴		
		01.96-09.98	57	Fg.Nr. 70..T..200 001→		LAB,MVB	0 265 006 408 ⁴		
						MVB,RAB	0 265 006 409 ⁴		
2.5		11.90-12.93	81				0 265 006 407 ³		
						LAB,MVB	0 265 006 508 ⁴		
						MVB,RAB	0 265 006 510 ⁴		
						MVB	0 986 594 013 ⁴		
		07.94-12.95	81	Fg.Nr. →70..T..199 000		MVB	0 986 594 013 ⁴		
		07.94-10.96	81				0 265 006 407 ³		
						LAB,MVB	0 265 006 508 ⁴		
						MVB,RAB	0 265 006 510 ⁴		
		09.95-12.95	81				0 265 006 407 ³		
						LAB,MVB	0 265 006 508 ⁴		
						MVB	0 986 594 013 ⁴		
		01.96-10.96	81	Fg.Nr. 70..T..200 001→		LAB,MVB	0 265 006 408 ⁴		
						MVB,RAB	0 265 006 409 ⁴		
		08.96-06.03	81				0 265 006 407 ³		
						LAB,MVB	0 265 006 508 ⁴		
						LAB,MVB	0 265 006 408 ⁴		
						MVB,RAB	0 265 006 510 ⁴		
						MVB,RAB	0 265 006 409 ⁴		
			85				0 265 006 407 ³		
						LAB,MVB	0 265 006 508 ⁴		
						LAB,MVB	0 265 006 408 ⁴		
						MVB,RAB	0 265 006 510 ⁴		
						MVB,RAB	0 265 006 409 ⁴		
2.5 Syncro		11.92-12.93	81			LAB,MVB	0 265 006 508 ⁴		
						MVB,RAB	0 265 006 510 ⁴		
						MVB	0 986 594 013 ⁴		
		11.92-10.96	81				0 265 006 407 ³		
		01.94-12.95	81	Fg.Nr. →70..T..199 000		MVB	0 986 594 013 ⁴		





VW Multivan T4 [70, 7D]



















2.5 Syncro	01.94-10.96	81		LAB,MVB	0 265 006 508 ⁴	
				MVB,RAB	0 265 006 510 ⁴	
	01.96-10.96	81	Fg.Nr. 70..T..200 001→	LAB,MVB	0 265 006 408 ⁴	
				MVB,RAB	0 265 006 409 ⁴	
	06.97-11.01	81			0 265 006 407 ³	
				LAB,MVB	0 265 006 508 ⁴	
				LAB,MVB	0 265 006 408 ⁴	
				MVB,RAB	0 265 006 510 ⁴	
				MVB,RAB	0 265 006 409 ⁴	
2.5 Syncro	08.96-06.03	65/85			0 265 006 407 ³	
2.5 TDI				LAB,MVB	0 265 006 508 ⁴	
				LAB,MVB	0 265 006 408 ⁴	
				MVB,RAB	0 265 006 510 ⁴	
				MVB,RAB	0 265 006 409 ⁴	
2.5 TDI	01.95-12.95	75	Fg.Nr. →70..T..199 000	MVB	0 986 594 013 ⁴	
	01.95-06.03	75			0 265 006 407 ³	
				LAB,MVB	0 265 006 508 ⁴	
				MVB,RAB	0 265 006 510 ⁴	
	01.96-06.03	75	Fg.Nr. 70..T..200 001→	LAB,MVB	0 265 006 408 ⁴	
				MVB,RAB	0 265 006 409 ⁴	
	05.99-06.03	75		LAB,MVB	0 265 006 408 ⁴	
				MVB,RAB	0 265 006 409 ⁴	
2.5 TDI	03.98-06.03	75/103/			0 265 006 407 ³	
2.5 TDI Syncro		111/150		LAB,MVB	0 265 006 508 ⁴	
				LAB,MVB	0 265 006 408 ⁴	
				MVB,RAB	0 265 006 510 ⁴	
				MVB,RAB	0 265 006 409 ⁴	
2.8	01.96-06.03	75/103/			0 265 006 407 ³	
		111/150		LAB,MVB	0 265 006 508 ⁴	
				LAB,MVB	0 265 006 408 ⁴	
				MVB,RAB	0 265 006 510 ⁴	
				MVB,RAB	0 265 006 409 ⁴	

	1.8	09.90-06.03	45/49/50/		0 265 005 214	
	1.9 D, D Turbo		55/57/62/			
	2.0		65/75/81/			
	2.4 D, D Syncro		85/103/			
	2.5, Syncro, TDI, TDI Syncro		111/150			
2.8						

Multivan T5 [7E]



	2.0	09.09→	62/75/85/	L55	1 987 481 182	558
	2.0 TDI		103			
	2.0 TDI 4 Motion					
	2.0	09.09→	62/75/85/		0 986 473 193	← 60
	2.0 TDI		103		0 986 474 193	→ 60
	2.0 TDI 4 Motion					
	2.0	09.09→	62/75/85/		1 987 476 309 ¹	250
	2.0 TDI		103			
	2.0 TDI 4 Motion					
	2.0	09.09→	62/75/85/			1 987 470 040 ⁷
	2.0 TDI		103			
	2.0 TDI 4 Motion					

		S							
									
	2.0, TDI	09.09→	62/75/85				1 987 477 260	↔ 1297	
	2.0 TDI	09.09→	103				1 987 477 260	↔ 1297	
	2.0 TDI 4 Motion	09.09→	103	PR-Nr. 1CP		FLR	1 987 482 017	↔ 2015	
Multivan T5 [7H]									
									
	1.9 TDI	02.03-11.09	62/63/75/			L55	1 987 481 182	558	
	2.0		77/85/96/						
	2.5 TDI, TDI 4 Motion		120/128/						
	3.2, 4 Motion		170/173						
	1.9 TDI	02.03-11.09	62/63/75/			308	0 986 473 193	↔ 60	
	2.0		77/85/96/				0 986 474 193	↔ 60	
	2.5 TDI, TDI 4 Motion		120/128/			333	0 986 473 181	↔ 59,96	
	3.2, 4 Motion		170/173				0 986 474 181	↔ 59,96	
									
	1.9 TDI	02.03-11.09	62/63/75/				1 987 476 309 ¹	250	
	2.0		77/85/96/				1 987 476 310 ²	190	
	2.5 TDI, TDI 4 Motion		120/128/	PR-Nr. OWR		LAB	1 987 476 313 ²	243	
	3.2, 4 Motion		170/173			RAB	1 987 476 320 ²	243	
	1.9 TDI	02.03-11.09	62/63/75/			294			1 987 470 040 ⁷
	2.0		77/85/96/			322	0 986 473 188	↔ 44	1 987 470 506 ⁸
	2.5 TDI, TDI 4 Motion		120/128/				0 986 474 188	↔ 44	1 987 470 506 ⁸
	3.2		170						
	3.2	05.03-11.09	173			294			1 987 470 040 ⁷
						322	0 986 473 188	↔ 44	1 987 470 506 ⁸
							0 986 474 188	↔ 44	1 987 470 506 ⁸
		05.08-11.09	173						1 987 470 040 ⁷
	3.2 4 Motion	07.04-11.09	173			294			1 987 470 040 ⁷
						322	0 986 473 188	↔ 44	1 987 470 506 ⁸
							0 986 474 188	↔ 44	1 987 470 506 ⁸
									
	1.9 TDI	04.03-11.09	62/63/75/	PR-Nr. 1AT			0 986 480 992	27	
	2.0		77/85						
	2.5 TDI	02.03-11.09	96			LLE	0 986 480 992	27	
			128			LLE	0 986 480 992	27	
		11.03-11.09	120	PR-Nr. 1AT			0 986 480 992	27	
		01.06-11.09	96	PR-Nr. 1AT			0 986 480 992	27	
			128	PR-Nr. 1AT			0 986 480 992	27	
	2.5 TDI 4 Motion	07.04-11.09	96/128			LLE	0 986 480 992	27	
		01.06-11.09	96/128				0 986 480 992	27	
	3.2	02.03-06.04	170	PR-Nr. 1AT			0 986 480 992	27	
		05.03-11.09	173	PR-Nr. 1AT			0 986 480 992	27	
	3.2 4 Motion	07.04-11.09	173				0 986 480 992	27	
	1.9 TDI	02.03-11.09	62/63/75/	PR-Nr. OWN, PR-Nr. OWP,			1 987 477 260	↔ 1297	
	2.0		77/85/96/	PR-Nr. OWQ, PR-Nr. OWL,					
				PR-Nr. OWM					
	2.5 TDI		120/128	PR-Nr. OWR			1 987 482 014	↔ 1270	
	2.5 TDI 4 Motion	07.04-11.09	96/128			FKR	1 987 482 016	↔ 1650	
						FLR	1 987 482 017	↔ 2015	





	◀ VW Multivan T5 [7H]									
	3.2	02.03-06.04	170	PR-Nr. OWN, PR-Nr. OWP, PR-Nr. OWQ, PR-Nr. OWL, PR-Nr. OWM		1987 477 260	↔ 1297			
				PR-Nr. OWR		1987 482 014	↔ 1270			
		05.03-11.09	173	PR-Nr. OWN, PR-Nr. OWP, PR-Nr. OWQ, PR-Nr. OWL, PR-Nr. OWM		1987 477 260	↔ 1297			
				PR-Nr. OWR		1987 482 014	↔ 1270			
	3.2 4 Motion	07.04-11.09	173		FKR	1987 482 016	↔ 1650			
					FLR	1987 482 017	↔ 2015			

	1.9 TDI	02.03-11.09	62/63/75/		LAB	0986 594 504				
	2.0		77/85/96/			0986 594 504 ³				
	2.5 TDI, TDI 4 Motion		120/128/			0986 594 504 ⁴				
	3.2, 4 Motion		170/173		RAB	0986 594 505				
						0986 594 505 ³				
						0986 594 505 ⁴				

Saveiro III















	1.9 D	ABO	09.01-05.02	47		BSY	0204 0A2 389			
	1.9 D		06.98-05.02	47		CSA	0265 216 416 ¹¹			
	1.9 D		06.98-05.02	47		LAB	0265 006 218 ³			
							0265 006 222 ⁴			
							0265 006 410 ⁴			
							0265 006 221 ⁴			
						RAB	0265 006 221 ⁴			
							0265 006 411 ⁴			

Taro [7A]

	2.4 D 4x4		04.89-03.97	58-61			0986 473 067		← 42,8	
							0986 474 067		→ 42,8	
	1.8 2.2 2.4 D		04.89-03.97	58-61/69			0986 475 876		↔ 22,19	

Transporter T3 [24, 25]

	1.6 D Turbo Syncro		03.86-07.92	51			1987 476 139		440	
	1.7 D		10.86-07.92	42		BMS	1987 476 139		440	
						FES	1987 476 138		380	
	1.9		08.86-10.88	54		BMS	1987 476 139		440	
						FES	1987 476 138		380	
	1.9 Syncro		02.85-07.92	57			1987 476 139		440	
10.86-10.88			54			1987 476 139		440		

		S							
2.1		07.85-07.92	64/68/70/82			BMS	1 987 476 139	440	
						FES	1 987 476 138	380	
2.1 Syncro		08.85-07.92	64/70/82				1 987 476 139	440	
 1.6 D Turbo Syncro		03.86-07.92	51			LUC	0 986 471 668 0 986 473 668	← 60	1 987 470 048 ⁷
							0 986 472 668 0 986 474 668	→ 60	1 987 470 048 ⁷
1.7 D		10.86-07.92	42			FSB,GIR	0 986 471 668 0 986 473 668	← 60	1 987 470 048 ⁷
							0 986 472 668 0 986 474 668	→ 60	1 987 470 048 ⁷
1.9		08.86-10.88	54			FSB,GIR	0 986 471 668 0 986 473 668	← 60	1 987 470 048 ⁷
							0 986 472 668 0 986 474 668	→ 60	1 987 470 048 ⁷
1.9 Syncro		02.85-07.92	57			LUC	0 986 471 668 0 986 473 668	← 60	1 987 470 048 ⁷
							0 986 472 668 0 986 474 668	→ 60	1 987 470 048 ⁷
		10.86-10.88	54			LUC	0 986 471 668 0 986 473 668	← 60	1 987 470 048 ⁷
							0 986 472 668 0 986 474 668	→ 60	1 987 470 048 ⁷
2.1		07.85-07.92	64/68/70/82			FSB,GIR	0 986 471 668 0 986 473 668	← 60	1 987 470 048 ⁷
							0 986 472 668 0 986 474 668	→ 60	1 987 470 048 ⁷
2.1 Syncro		08.85-07.92	64/70/82			LUC	0 986 471 668 0 986 473 668	← 60	1 987 470 048 ⁷
							0 986 472 668 0 986 474 668	→ 60	1 987 470 048 ⁷
									
 1.6 D Turbo Syncro		02.85-07.92	42/51/54/57/64/68/70/82				1 987 476 216	180	
1.7 D									
1.9, Syncro									
2.1, Syncro									
 1.7 D		07.85-07.92	42/54/64/68/70/82				F 026 002 305	↔ 23,8	
1.9									
2.1									
									
 1.6 D Turbo Syncro		03.86-07.92	51			BKV	0 204 123 029	23,8	
						FBM	0 986 480 641	23,8	
1.7 D		08.86-07.92	42/54			FBM	0 986 480 641	23,8	
1.9						FBM	0 204 123 029	23,8	1 987 472 294
1.9 Syncro		02.85-07.92	57			BKV	0 204 123 029	23,8	
						FBM	0 986 480 641	23,8	
		10.86-10.88	42/54			FBM	0 986 480 641	23,8	
2.1		07.85-07.92	64/68/70/82			FBM	0 986 480 641	23,8	
						FBM	0 204 123 029	23,8	1 987 472 294
2.1 Syncro		08.85-07.92	70/82			BKV	0 204 123 029	23,8	
						FBM	0 986 480 641	23,8	
		10.86-07.92	64			FBM	0 986 480 641	23,8	
 1.6 D Turbo Syncro		03.86-07.92	51				0 986 485 103		
1.7 D		10.86-07.92	42			Fg.Nr. 24-A-000 001→	ATE	0 986 485 103	
1.9		08.86-10.88	54			Fg.Nr. 24-A-000 001→	ATE	0 986 485 103	





VW Transporter T3 [24, 25]

	1.9 Syncro	02.85-07.92	57		0 986 485 103	
		10.86-10.88	54		0 986 485 103	
	2.1	07.85-07.92	64/68/70/82	Fg.Nr. 24-A-000 001→	ATE 0 986 485 103	
	2.1 Syncro	08.85-07.92	64/70/82		0 986 485 103	

	1.6 D Turbo Syncro	02.85-07.92	42/51/54/		0 986 486 002	
	1.7 D		57/64/68/			
	1.9, Syncro		70/82			
	2.1, Syncro					

	1.6 D Turbo Syncro	02.85-07.92	42/51/54/		0 986 486 507	
	1.7 D		57/64/68/			
	1.9, Syncro		70/82			
	2.1, Syncro					

	1.6 D Turbo Syncro	03.86-07.92	51	14Z	1 987 482 215	← 1882
					1 987 482 216	→ 1083
					1 987 482 217	← 1534
					1 987 482 218	→ 1477
	1.7 D	10.86-07.92	42		1 987 477 040	↔ 1475
					1 987 477 040	↔ 1475
	1.9	08.86-10.88	54		1 987 482 215	← 1882
					1 987 482 216	→ 1083
	1.9 Syncro	02.85-07.92	57	14Z	1 987 482 217	← 1534
					1 987 482 218	→ 1477
				16Z	1 987 482 215	← 1882
					1 987 482 216	→ 1083
2.1	07.85-07.92	64/68/70/82		1 987 482 217	← 1534	
				1 987 482 218	→ 1477	
				1 987 477 040	↔ 1475	
				1 987 477 040	↔ 1475	
2.1 Syncro	08.85-07.92	64/70/82	14Z	1 987 482 215	← 1882	
				1 987 482 216	→ 1083	
			16Z	1 987 482 217	← 1534	
				1 987 482 218	→ 1477	



































	1.6 D, D Turbo	08.85-07.92	37/42/44/		0 265 103 023 ¹⁶	
	1.7 D		51/57/82			
	1.9					
	2.1					

	1.6 D, D Turbo	08.85-07.92	37/40/42/		0 265 001 151 ⁴	
	1.7 D		44/51/54/			
	1.9		57/64/68/			
	2.1		70/82			

Transporter T4 [70, 7D]

















	1.8	12.90-07.92	49	MVB	1 987 476 411	330
	1.9 D	09.90-12.95	45	MVB	1 987 476 411	330
		01.96-04.97	45	MVB	1 987 476 698	375
		10.92-12.95	50	MVB	1 987 476 411	330
	1.9 D Turbo	01.96-04.98	50	MVB	1 987 476 698	375
		05.98-06.03	50	MVB	1 987 476 698	375
		09.90-12.95	62	MVB	1 987 476 411	330
	2.0	01.96-04.98	62	MVB	1 987 476 698	375
		05.98-06.03	62	MVB	1 987 476 698	375

		S							
2.4 D	09.90-12.95	57				MVB	1 987 476 411	330	
	01.96-04.98	57				MVB	1 987 476 698	375	
	05.97-04.98	55				MVB	1 987 476 698	375	
	05.98-05.98	57				MVB	1 987 476 698	375	
	05.98-06.03	55				MVB	1 987 476 698	375	
2.4 D Syncro	11.92-12.95	57				MVB	1 987 476 411	330	
	01.96-04.98	57				MVB	1 987 476 698	375	
	05.98-09.98	57				MVB	1 987 476 698	375	
2.5	11.90-12.95	81				MVB	1 987 476 411	330	
	01.96-04.98	81				MVB	1 987 476 698	375	
	08.96-04.98	85				MVB	1 987 476 698	375	
	05.98-06.03	81				MVB	1 987 476 698	375	
		85				MVB	1 987 476 698	375	
2.5 Syncro	11.92-12.95	81				MVB	1 987 476 411	330	
	01.96-10.96	81				MVB	1 987 476 698	375	
	05.96-04.98	85				MVB	1 987 476 698	375	
	06.97-04.98	81				MVB	1 987 476 698	375	
	05.98-11.01	81				MVB	1 987 476 698	375	
	05.98-06.03	85				MVB	1 987 476 698	375	
2.5 TDI	01.95-12.95	75				MVB	1 987 476 411	330	
	01.96-04.98	75				MVB	1 987 476 698	375	
	05.98-06.03	65				MVB	1 987 476 698	375	
		75				MVB	1 987 476 698	375	
		111				MVB	1 987 476 698	375	
2.5 TDI Syncro	05.99-06.03	75				MVB	1 987 476 698	375	
	03.98-04.98	75				MVB	1 987 476 698	375	
	05.98-06.03	75				MVB	1 987 476 698	375	
	04.01-06.03	75				MVB	1 987 476 698	375	
2.8	01.96-04.98	103				MVB	1 987 476 698	375	
	05.98-05.00	103				MVB	1 987 476 698	375	
	05.00-06.03	150				MVB	1 987 476 698	375	
 1.8	09.90-04.98	45/49/50/	PR-Nr. 1LP	281		0 986 473 177	 ← 53,93		
	1.9 D	55/57/62/				0 986 474 177	 → 53,93		
	1.9 D Turbo	81/85							
	2.0	09.90-06.03	45/49/50/	PR-Nr. 1LA	266		0 986 473 703	 ← 54	
	2.4 D		55/57/62/				0 986 474 703	 → 54	
	2.4 D Syncro		81/85	PR-Nr. 1LB	1KX		0 986 473 184	 ← 57	
	2.5						0 986 474 184	 → 57	
	2.5 Syncro				326		0 986 473 178	 ← 56,96	1 987 470 005 ⁷
							0 986 474 178	 → 56,96	1 987 470 005 ⁷
				PR-Nr. 1LE	284	LUC	0 986 473 806	 ← 54	
							0 986 473 807	 → 54	
				PR-Nr. 1LU	284	ATE	0 986 473 361	 ← 56,93	1 987 470 005 ⁷
							0 986 473 361	 ← 56,93	1 987 470 506 ⁸
							0 986 474 361	 → 56,93	1 987 470 506 ⁸
	2.5 TDI	01.95-04.98	75	PR-Nr. 1LP	281		0 986 473 177	 ← 53,93	
							0 986 474 177	 → 53,93	
		01.95-06.03	75	PR-Nr. 1LA	266		0 986 473 703	 ← 54	
						0 986 474 703	 → 54		
				PR-Nr. 1LB	1KX		0 986 473 184	 ← 57	
							0 986 474 184	 → 57	
					326		0 986 473 178	 ← 56,96	1 987 470 005 ⁷
							0 986 474 178	 → 56,96	1 987 470 005 ⁷
				PR-Nr. 1LE	284	LUC	0 986 473 806	 ← 54	
							0 986 473 807	 → 54	
				PR-Nr. 1LU	284	ATE	0 986 473 361	 ← 56,93	1 987 470 005 ⁷
							0 986 473 361	 ← 56,93	1 987 470 506 ⁸
							0 986 474 361	 → 56,93	1 987 470 506 ⁸



◀ VW Transporter T4 [70, 7D]											
2.5 TDI	05.98-06.03	65	PR-Nr. 1LA	266	0986 473 703			← 54			
					0986 474 703			→ 54			
			PR-Nr. 1LB		1KX	0986 473 184			← 57		
						0986 474 184			→ 57		
					326	0986 473 178			← 56,96	1987 470 005 ⁷	
						0986 474 178			→ 56,96	1987 470 005 ⁷	
	PR-Nr. 1LE		284	LUC	0986 473 806			← 54			
					0986 473 807			→ 54			
	PR-Nr. 1LU		284	ATE	0986 473 361			← 56,93	1987 470 005 ⁷		
					0986 473 361			← 56,93	1987 470 506 ⁸		
					0986 474 361			→ 56,93	1987 470 506 ⁸		
	111	03.98-06.03	75/103	PR-Nr. 1LA	266	0986 473 703			← 54		
						0986 474 703			→ 54		
				PR-Nr. 1LB		1KX	0986 473 184			← 57	
							0986 474 184			→ 57	
						326	0986 473 178			← 56,96	1987 470 005 ⁷
							0986 474 178			→ 56,96	1987 470 005 ⁷
		PR-Nr. 1LE		284	LUC	0986 473 806			← 54		
		0986 473 807					→ 54				
PR-Nr. 1LU		284	ATE	0986 473 361			← 56,93	1987 470 005 ⁷			
				0986 473 361			← 56,93	1987 470 506 ⁸			
				0986 474 361			→ 56,93	1987 470 506 ⁸			
2.5 TDI Syncro		03.98-04.98	75/103	PR-Nr. 1LP		281	0986 473 177			← 53,93	
							0986 474 177			→ 53,93	
		03.98-06.03	75/103	PR-Nr. 1LA		266	0986 473 703			← 54	
							0986 474 703			→ 54	
				PR-Nr. 1LB		1KX	0986 473 184			← 57	
							0986 474 184			→ 57	
						326	0986 473 178			← 56,96	1987 470 005 ⁷
				0986 474 178				→ 56,96	1987 470 005 ⁷		
	PR-Nr. 1LE		284	LUC	0986 473 806			← 54			
					0986 473 807			→ 54			
	PR-Nr. 1LU		284	ATE	0986 473 361			← 56,93	1987 470 005 ⁷		
					0986 473 361			← 56,93	1987 470 506 ⁸		
		0986 474 361				→ 56,93	1987 470 506 ⁸				
2.8	01.96-04.98	75/103	PR-Nr. 1LP		281	0986 473 177			← 53,93		
						0986 474 177			→ 53,93		
			01.96-05.00	75/103	PR-Nr. 1LA		266	0986 473 703			← 54
								0986 474 703			→ 54
					PR-Nr. 1LB		1KX	0986 473 184			← 57
								0986 474 184			→ 57
					326	0986 473 178			← 56,96	1987 470 005 ⁷	
						0986 474 178			→ 56,96	1987 470 005 ⁷	
	PR-Nr. 1LE		284	LUC	0986 473 806			← 54			
					0986 473 807			→ 54			
	PR-Nr. 1LU		284	ATE	0986 473 361			← 56,93	1987 470 005 ⁷		
					0986 473 361			← 56,93	1987 470 506 ⁸		
					0986 474 361			→ 56,93	1987 470 506 ⁸		
	05.00-06.03	150	PR-Nr. 1LA		266	0986 473 703			← 54		
						0986 474 703			→ 54		
			PR-Nr. 1LB		1KX	0986 473 184			← 57		
						0986 474 184			→ 57		
					326	0986 473 178			← 56,96	1987 470 005 ⁷	
			0986 474 178				→ 56,96	1987 470 005 ⁷			
PR-Nr. 1LE		284	LUC	0986 473 806			← 54				
				0986 473 807			→ 54				
PR-Nr. 1LU		284	ATE	0986 473 361			← 56,93	1987 470 005 ⁷			
				0986 473 361			← 56,93	1987 470 506 ⁸			
				0986 474 361			→ 56,93	1987 470 506 ⁸			



		S								
										
	1.8	09.90-06.03	45/49/50/				SSZ	1 987 476 220	160	
	1.9 D, D Turbo		55/57/62/							
	2.0		65/75/81/							
	2.4 D, D Syncro		85/111							
	2.5, Syncro, TDI									
2.5 TDI Syncro	03.98-06.03	75					SSZ	1 987 476 220	160	
	04.01-06.03	75						1 987 476 220 ¹	160	
								1 987 476 230 ²	160	
2.8	01.96-06.03	103/150					SSZ	1 987 476 220	160	
										
	1.8	09.90-06.03	45/49/50/					0 986 475 935	↔ 20,64	
	1.9 D, D Turbo		55/57/62/							
	2.0		65/75/81/							
	2.4 D, D Syncro		85/103/							
	2.5, Syncro, TDI, TDI Syncro		111/150							
2.8										
										
	1.8	ABO, 12.90-07.92	49					F 026 003 563	22	
		OFD								
		ABS, 12.90-07.92	49						0 986 480 834	22,19
	1.9 D	ABO, 06.95-06.03	45/50/62	Fg.Nr. 70..S..127 806→					0 986 480 930	23,8
		1.9 D Turbo	ABO, 09.90-05.95	45/50/62	Fg.Nr. →70..S..127 805				F 026 003 563	22
	2.0	OFD								
		ABS, 09.90-05.95	45/50/62	Fg.Nr. →70..S..127 805					0 986 480 834	22,19
		ABS, 06.95-06.03	45/50/62	Fg.Nr. 70..S..127 806→					0 986 480 933	23,8
		OFD								
	2.4 D	ABO, 06.95-06.03	45/50/62	Fg.Nr. 70..S..127 806→					0 986 480 930	23,8
		ABO, 09.90-05.95	45/50/62	Fg.Nr. →70..S..127 805					F 026 003 563	22
		OFD								
		ABS, 09.90-05.95	45/50/62	Fg.Nr. →70..S..127 805					0 986 480 834	22,19
	2.4 D Syncro	ABS, 06.95-06.03	45/50/62	Fg.Nr. 70..S..127 806→					0 986 480 933	23,8
		OFD								
		ABO, 05.97-06.03	55						0 986 480 930	23,8
		ABS, 05.97-06.03	55						0 986 480 933	23,8
	2.5	OFD								
		ABO, 06.95-09.98	57	Fg.Nr. 70..S..127 806→					0 986 480 930	23,8
		ABO, 09.90-05.95	57	Fg.Nr. →70..S..127 805					F 026 003 563	22
		OFD								
	2.5 Syncro	ABS, 09.90-05.95	57	Fg.Nr. →70..S..127 805					0 986 480 834	22,19
		ABS, 06.95-09.98	57	Fg.Nr. 70..S..127 806→					0 986 480 933	23,8
		OFD								
		ABO, 06.95-10.96	81	Fg.Nr. 70..S..127 806→					0 986 480 930	23,8
	2.5 Syncro	09.95-12.95	81						0 986 480 930	23,8
		08.96-06.03	81						0 986 480 930	23,8
		ABS, 06.95-10.96	81	Fg.Nr. 70..S..127 806→					0 986 480 933	23,8
		OFD, 09.95-12.95	81						0 986 480 933	23,8
	2.5 Syncro	08.96-06.03	81						0 986 480 933	23,8
		ABO, 05.96-06.03	85						0 986 480 930	23,8
		ABO, 11.90-12.93	81						F 026 003 563	22
OFD, 01.94-05.95		81	Fg.Nr. →70..S..127 805					F 026 003 563	22	
2.5 Syncro	ABS, 11.90-12.93	81						0 986 480 834	22,19	
	01.94-05.95	81	Fg.Nr. →70..S..127 805					0 986 480 834	22,19	
	ABS, 05.96-06.03	85						0 986 480 933	23,8	
	OFD									
2.5 Syncro	ABO, 06.95-10.96	81	Fg.Nr. 70..S..127 806→					0 986 480 930	23,8	
	06.97-11.01	81						0 986 480 930	23,8	
	ABS, 06.95-10.96	81	Fg.Nr. 70..S..127 806→					0 986 480 933	23,8	
	OFD, 06.97-11.01	81						0 986 480 933	23,8	





◀ VW Transporter T4 [70, 7D]

	2.5 TDI	ABO	06.95-06.03	75	Fg.Nr. 70..S..127 806→	0986	480 930	23,8
			05.98-06.03	65		0986	480 930	23,8
				111		0986	480 930	23,8
			05.99-06.03	75		0986	480 930	23,8
		ABO,	01.95-05.95	75	Fg.Nr. →70..S..127 805	F 026	003 563	22
		OFD						
		ABS	01.95-05.95	75	Fg.Nr. →70..S..127 805	0986	480 834	22,19
		ABS,	06.95-06.03	75	Fg.Nr. 70..S..127 806→	0986	480 933	23,8
		OFD	05.98-06.03	65		0986	480 933	23,8
				111		0986	480 933	23,8
			05.99-06.03	75		0986	480 933	23,8
2.5 TDI Syncro	ABO	03.98-06.03	75		0986	480 930	23,8	
	ABS	04.01-06.03	75		0986	480 933	23,8	
	ABS,	03.98-06.03	75		0986	480 933	23,8	
	OFD							
2.8	ABO	01.96-06.03	103/150		0986	480 930	23,8	
	ABS,	01.96-06.03	103/150		0986	480 933	23,8	
	OFD							











	1.8	OFD	12.90-07.92	49		0986	485 112	
	1.9 D, D Turbo	OFD	09.90-05.95	45/50/57/	Fg.Nr. →70..S..127 805	0986	485 112	
	2.0			62				
	2.4 D, D Syncro							
	2.5	OFD	11.90-12.93	81		0986	485 112	
	2.5 Syncro		01.94-05.95	81	Fg.Nr. →70..S..127 805	0986	485 112	
	2.5 TDI	OFD	01.95-05.95	75	Fg.Nr. →70..S..127 805	0986	485 112	

	1.8		09.90-06.03	45/49/50/	TW	0986	486 037		
	1.9 D, D Turbo			55/57/62/		0986	486 048		
	2.0			65/75/81/					
	2.4 D, D Syncro			85/111					
	2.5, Syncro, TDI								
	2.5 TDI Syncro		03.98-06.03	75		TW	0986	486 037	
							0986	486 048	
			04.01-06.03	75			0986	486 048	
	2.8		01.96-06.03	103/150		TW	0986	486 037	
							0986	486 048	

	1.8		09.90-04.97	45/49		0986	486 537	
	1.9 D							
	1.9 D Turbo		09.90-04.97	50/62		0986	486 537	
	2.0		05.97-06.03	50/62		0986	486 538	
	2.4 D		05.97-06.03	55		0986	486 538	
	2.4 D, D Syncro		09.90-04.97	57/81/85		0986	486 537	
	2.5, Syncro		05.97-06.03	57/81/85		0986	486 538	
	2.5 TDI		05.98-06.03	65/150		0986	486 538	
	2.8							

	1.8		09.90-06.03	45/49/50/		0 204	031 292¹⁰	
	1.9 D, D Turbo			55/57/62/				
	2.0			65/75/81/				
	2.4 D, D Syncro			85/103/				
	2.5, Syncro, TDI, TDI Syncro			111/150				
	2.8							

	1.8		12.90-07.92	49		1 987	477 171	↔ 854	
	1.9 D, D Turbo		09.90-02.97	45/50/62	Fg.Nr. →70..V..120 000	SBR	1 987	477 706	↔ 938
	2.0		09.90-06.03	45/50/62		TBR	1 987	477 171	↔ 854
			03.97-06.03	45/50/62	Fg.Nr. 70..V..120 001→	SBR	1 987	477 707	↔ 948

		S								
2.4 D	09.90-02.97	57	Fg.Nr. →70..V..120 000	SBR	1 987 477 706	↔ 938				
	09.90-05.98	57		TBR	1 987 477 171	↔ 854				
	03.97-05.98	57	Fg.Nr. 70..V..120 001→	SBR	1 987 477 707	↔ 948				
	05.97-06.03	55		TBR	1 987 477 707	↔ 948				
2.4 D Syncro	11.92-04.97	57		SBR	1 987 477 706	↔ 938				
	11.92-09.98	57		TBR	1 987 477 171	↔ 854				
	05.97-09.98	57		SBR	1 987 477 707	↔ 948				
2.5	11.90-12.93	81			1 987 477 171	↔ 854				
	01.94-10.96	81		SBR	1 987 477 706	↔ 938				
	01.94-06.03	81		TBR	1 987 477 171	↔ 854				
	09.95-12.95	81			1 987 477 171	↔ 854				
	08.96-02.97	81	Fg.Nr. →70..V..120 000	SBR	1 987 477 706	↔ 938				
		85	Fg.Nr. →70..V..120 000	SBR	1 987 477 706	↔ 938				
	08.96-06.03	85		TBR	1 987 477 171	↔ 854				
	03.97-06.03	81	Fg.Nr. 70..V..120 001→	SBR	1 987 477 707	↔ 948				
		85	Fg.Nr. 70..V..120 001→	SBR	1 987 477 707	↔ 948				
	05.99-06.03	85		SBR	1 987 477 707	↔ 948				
	2.5 Syncro	11.92-04.97	81/85		SBR	1 987 477 706	↔ 938			
11.92-06.03		81/85		TBR	1 987 477 171	↔ 854				
05.97-06.03		81/85		SBR	1 987 477 707	↔ 948				
2.5 TDI	01.95-02.97	75	Fg.Nr. →70..V..120 000	SBR	1 987 477 706	↔ 938				
	01.95-06.03	75		TBR	1 987 477 171	↔ 854				
	03.97-06.03	75	Fg.Nr. 70..V..120 001→	SBR	1 987 477 707	↔ 948				
	05.98-06.03	65		SBR	1 987 477 707	↔ 948				
		111		TBR	1 987 477 171	↔ 854				
				SBR	1 987 477 707	↔ 948				
				TBR	1 987 477 171	↔ 854				
	05.99-06.03	75		SBR	1 987 477 707	↔ 948				
2.5 TDI Syncro	03.98-06.03	75		SBR	1 987 477 707	↔ 948				
				TBR	1 987 477 171	↔ 854				
	04.01-06.03	75			1 987 477 706	↔ 938				
2.8	01.96-02.97	103	Fg.Nr. →70..V..120 000	SBR	1 987 477 706	↔ 938				
	01.96-05.00	103		TBR	1 987 477 171	↔ 854				
	03.97-05.00	103	Fg.Nr. 70..V..120 001→	SBR	1 987 477 707	↔ 948				
	05.00-06.03	150		SBR	1 987 477 707	↔ 948				
				TBR	1 987 477 171	↔ 854				
	1.8	12.90-07.92	49		0 265 202 454 ²⁰					
	1.9 D, D Turbo	09.90-06.03	45/50/55/57/62/65/75/81/85/111		0 265 202 454 ²⁰					
	2.0	01.96-06.03	45/50/55/57/62/65/75/81/85/111		0 265 220 434 ¹⁴					
	2.4 D, D Syncro									
	2.5, Syncro, TDI, TDI Syncro									
2.8	01.96-05.00	103			0 265 202 454 ²⁰					
	10.97-05.00	103	Fg.Nr. 70..W..062 420→		0 265 220 434 ¹⁴					
	05.00-06.03	150			0 265 202 454 ²⁰					
					0 265 220 434 ¹⁴					
	1.8	09.90-12.95	45/49/50/62		0 265 100 072 ¹⁶					
	1.9 D, D Turbo	09.90-06.03	45/49/50/62	1KX,326	0 265 109 612 ²⁰					
	2.0			281,284,GRG	0 265 109 602 ²⁰					
	2.4 D	05.97-06.03	55		1KX,326	0 265 109 612 ²⁰				
					281,284,GRG	0 265 109 602 ²⁰				
	2.4 D	09.90-12.95	57/81			0 265 100 072 ¹⁶				
	2.4 D Syncro	09.90-06.03	57/81		1KX,326	0 265 109 612 ²⁰				
	2.5				281,284,GRG	0 265 109 602 ²⁰				
	2.5	08.96-06.03	85		1KX,326	0 265 109 612 ²⁰				
				281,284,GRG	0 265 109 602 ²⁰					





 ◀ VW Transporter T4 [70, 7D]

2.5 Syncro	11.92-12.93	81		1KX,326	0 265 109 612 ²⁰
				281,284,GRG	0 265 109 602 ²⁰
	11.92-12.95	81			0 265 100 072 ¹⁶
	01.94-10.96	81		1KX,326	0 265 109 612 ²⁰
				281,284,GRG	0 265 109 602 ²⁰
	06.97-11.01	81		1KX,326	0 265 109 612 ²⁰
				281,284,GRG	0 265 109 602 ²⁰
2.5 Syncro	05.96-06.03	65/85		1KX,326	0 265 109 612 ²⁰
2.5 TDI				281,284,GRG	0 265 109 602 ²⁰
2.5 TDI	01.95-12.95	75			0 265 100 072 ¹⁶
	01.95-06.03	75		1KX,326	0 265 109 612 ²⁰
				281,284,GRG	0 265 109 602 ²⁰
	05.98-06.03	111		1KX,326	0 265 109 612 ²⁰
				281,284,GRG	0 265 109 602 ²⁰
2.5 TDI Syncro	03.98-06.03	75		1KX,326	0 265 109 612 ²⁰
				281,284,GRG	0 265 109 602 ²⁰
	04.01-05.02	75	Fg.Nr. →70..3..019 101	GRG	0 265 109 602 ²⁰
	06.02-06.03	75	Fg.Nr. 70..3..019 102→		0 265 109 612 ²⁰
2.8	01.96-06.03	103/150		1KX,326	0 265 109 612 ²⁰
				281,284,GRG	0 265 109 602 ²⁰
 1.8	12.90-07.92	49			0 265 006 407 ³
				LAB,MVB	0 265 006 508 ⁴
				MVB,RAB	0 265 006 510 ⁴
				MVB	0 986 594 013 ⁴
1.9 D	09.90-12.95	45/50/62	Fg.Nr. →70..T..199 000	MVB	0 986 594 013 ⁴
1.9 D Turbo	09.90-06.03	45/50/62			0 265 006 407 ³
2.0				LAB,MVB	0 265 006 508 ⁴
				MVB,RAB	0 265 006 510 ⁴
	01.96-06.03	45/50/62	Fg.Nr. 70..T..200 001→	LAB,MVB	0 265 006 408 ⁴
			MVB,RAB	0 265 006 409 ⁴	
2.4 D	05.97-06.03	55			0 265 006 407 ³
				LAB,MVB	0 265 006 508 ⁴
				LAB,MVB	0 265 006 408 ⁴
				MVB,RAB	0 265 006 510 ⁴
				MVB,RAB	0 265 006 409 ⁴
2.4 D	09.90-12.95	57	Fg.Nr. →70..T..199 000	MVB	0 986 594 013 ⁴
2.4 D Syncro	09.90-09.98	57			0 265 006 407 ³
				LAB,MVB	0 265 006 508 ⁴
				MVB,RAB	0 265 006 510 ⁴
	01.96-09.98	57	Fg.Nr. 70..T..200 001→	LAB,MVB	0 265 006 408 ⁴
				MVB,RAB	0 265 006 409 ⁴
2.5	11.90-12.93	81		MVB	0 986 594 013 ⁴
	11.90-10.96	81			0 265 006 407 ³
				LAB,MVB	0 265 006 508 ⁴
	11.90-06.03	81		MVB,RAB	0 265 006 510 ⁴
	01.94-12.95	81	Fg.Nr. →70..T..199 000	MVB	0 986 594 013 ⁴
	09.95-12.95	81			0 265 006 407 ³
				LAB,MVB	0 265 006 508 ⁴
				MVB	0 986 594 013 ⁴
	01.96-10.96	81	Fg.Nr. 70..T..200 001→	LAB,MVB	0 265 006 408 ⁴
				MVB,RAB	0 265 006 409 ⁴
	08.96-06.03	81			0 265 006 407 ³
				LAB,MVB	0 265 006 508 ⁴
				LAB,MVB	0 265 006 408 ⁴
			MVB,RAB	0 265 006 409 ⁴	
		85			0 265 006 407 ³
				LAB,MVB	0 265 006 508 ⁴
				LAB,MVB	0 265 006 408 ⁴
				MVB,RAB	0 265 006 510 ⁴
				MVB,RAB	0 265 006 409 ⁴



	S									
2.5 Syncro	11.92-12.93	81	Fg.Nr. →70..T..199 000 Fg.Nr. 70..T..200 001→	MVB	0 986 594 013 ⁴					
									11.92-10.96	81
						LAB,MVB	0 265 006 508 ⁴			
						MVB,RAB	0 265 006 510 ⁴			
	01.94-12.95	81			MVB	0 986 594 013 ⁴				
	01.96-10.96	81			LAB,MVB	0 265 006 408 ⁴				
	06.97-11.01	81				MVB,RAB	0 265 006 409 ⁴			
						0 265 006 407 ³				
						LAB,MVB	0 265 006 508 ⁴			
						LAB,MVB	0 265 006 408 ⁴			
MVB,RAB			0 265 006 510 ⁴							
MVB,RAB			0 265 006 409 ⁴							
2.5 Syncro	05.96-06.03	65/85			0 265 006 407 ³					
2.5 TDI				LAB,MVB	0 265 006 508 ⁴					
				LAB,MVB	0 265 006 408 ⁴					
				MVB,RAB	0 265 006 510 ⁴					
				MVB,RAB	0 265 006 409 ⁴					
2.5 TDI	01.95-12.95	75	Fg.Nr. →70..T..199 000 Fg.Nr. 70..T..200 001→	MVB	0 986 594 013 ⁴					
									01.95-06.03	75
						LAB,MVB	0 265 006 508 ⁴			
						MVB,RAB	0 265 006 510 ⁴			
	01.96-06.03	75			LAB,MVB	0 265 006 408 ⁴				
	05.99-06.03	75				MVB,RAB	0 265 006 409 ⁴			
						LAB,MVB	0 265 006 408 ⁴			
						MVB,RAB	0 265 006 409 ⁴			
2.5 TDI	03.98-06.03	75/103/			0 265 006 407 ³					
2.5 TDI Syncro		111/150		LAB,MVB	0 265 006 508 ⁴					
				LAB,MVB	0 265 006 408 ⁴					
				MVB,RAB	0 265 006 510 ⁴					
				MVB,RAB	0 265 006 409 ⁴					
2.8	01.96-06.03	75/103/ 111/150			0 265 006 407 ³					
				LAB,MVB	0 265 006 508 ⁴					
				LAB,MVB	0 265 006 408 ⁴					
				MVB,RAB	0 265 006 510 ⁴					
				MVB,RAB	0 265 006 409 ⁴					

	1.8	09.90-06.03	45/49/50/		0 265 005 214		
	1.9 D, D Turbo		55/57/62/				
	2.0		65/75/81/				
	2.4 D, D Syncro		85/103/				
	2.5, Syncro, TDI, TDI Syncro		111/150				
2.8							

Transporter T5 [7E]

	2.0	09.09→	62/75/85/	L55	1 987 481 182	558
	2.0 TDI		103/132			
	2.0 TDI 4 Motion					
	2.0	09.09→	62/75/85/		0 986 473 193	60
	2.0 TDI		103		0 986 474 193	60
	2.0 TDI 4 Motion					
	2.0	09.09→	62/75/85/		1 987 476 309 ¹	250
	2.0 TDI		103/132			
	2.0 TDI 4 Motion					



		S				?			
◀ VW Transporter T5 [7E]									
	2.0 2.0 TDI 2.0 TDI 4 Motion	09.09→	62/75/85/ 103/132						1987 470 040 ⁷
	2.0, TDI 2.0 TDI 4 Motion	09.09→ 09.09→	62/75/85/103/132 103/132	PR-Nr. 1CP	FLR		1987 477 260 1987 482 017	↔ 1297 ↔ 2015	
Transporter T5 [7F]									
	2.0 TDI	09.09→	103		L55		1987 481 182	558	
	2.0 TDI	09.09→	103				1987 476 309 ¹	250	
	2.0 TDI	09.09→	103				1987 477 260	↔ 1297	
Transporter T5 [7H]									
	1.9 TDI 2.0 2.5 TDI, TDI 4 Motion 3.2, 4 Motion	02.03-11.09	62/63/75/ 77/85/96/ 120/128/ 170/173		L55		1987 481 182	558	
	1.9 TDI 2.0 2.5 TDI, TDI 4 Motion 3.2, 4 Motion	02.03-11.09	62/63/75/ 77/85/96/ 120/128/ 170/173		308 333		0986 473 193 0986 474 193 0986 473 181 0986 474 181	👁️ ← 60 👁️ → 60 👁️ ← 59,96 👁️ → 59,96	
	1.9 TDI 2.0 2.5 TDI, TDI 4 Motion 3.2, 4 Motion	02.03-11.09	62/63/75/ 77/85/96/ 120/128/ 170/173	PR-Nr. OWR	LAB RAB		1987 476 309 ¹ 1987 476 310 ² 1987 476 313 ² 1987 476 320 ²	250 190 243 243	
	1.9 TDI 2.0 2.5 TDI, TDI 4 Motion 3.2 3.2	02.03-11.09	62/63/75/ 77/85/96/ 120/128/170		294 322		0986 473 188 0986 474 188	👁️ ← 44 👁️ → 44	1987 470 040 ⁷ 1987 470 506 ⁸ 1987 470 506 ⁸
	3.2 3.2	05.03-11.09	173		294 322		0986 473 188 0986 474 188	👁️ ← 44 👁️ → 44	1987 470 040 ⁷ 1987 470 506 ⁸ 1987 470 506 ⁸
		05.08-11.09	173						1987 470 040 ⁷
	3.2 4 Motion	07.04-11.09	173		294 322		0986 473 188 0986 474 188	👁️ ← 44 👁️ → 44	1987 470 040 ⁷ 1987 470 506 ⁸ 1987 470 506 ⁸





	1.9 TDI	04.03-11.09	62/63/75/77/85	PR-Nr. 1AT		0 986 480 992	27	
	2.0							
	2.5 TDI	02.03-11.09	96		LLE	0 986 480 992	27	
				128	LLE	0 986 480 992	27	
		11.03-11.09	120		PR-Nr. 1AT	0 986 480 992	27	
		01.06-11.09	96		PR-Nr. 1AT	0 986 480 992	27	
			128		PR-Nr. 1AT	0 986 480 992	27	
	2.5 TDI 4 Motion	07.04-11.09	96/128			LLE	0 986 480 992	27
		01.06-11.09	96/128				0 986 480 992	27
	3.2	02.03-06.04	170			PR-Nr. 1AT	0 986 480 992	27
05.03-11.09		173			PR-Nr. 1AT	0 986 480 992	27	
3.2 4 Motion	07.04-11.09	173				0 986 480 992	27	

	1.9 TDI	02.03-11.09	62/63/75/77/85/96/120/128	PR-Nr. OWN, PR-Nr. OWP, PR-Nr. OWQ, PR-Nr. OWL, PR-Nr. OWM		1 987 477 260	↔ 1297	
	2.0							
	2.5 TDI				PR-Nr. OWR	1 987 482 014	↔ 1270	
	2.5 TDI 4 Motion	07.04-11.09	96/128			FKR	1 987 482 016	↔ 1650
						FLR	1 987 482 017	↔ 2015
	3.2	02.03-06.04	170		PR-Nr. OWN, PR-Nr. OWP, PR-Nr. OWQ, PR-Nr. OWL, PR-Nr. OWM		1 987 477 260	↔ 1297
					PR-Nr. OWR	1 987 482 014	↔ 1270	
		05.03-11.09	173		PR-Nr. OWN, PR-Nr. OWP, PR-Nr. OWQ, PR-Nr. OWL, PR-Nr. OWM		1 987 477 260	↔ 1297
					PR-Nr. OWR	1 987 482 014	↔ 1270	
	3.2 4 Motion	07.04-11.09	173			FKR	1 987 482 016	↔ 1650
					FLR	1 987 482 017	↔ 2015	

	1.9 TDI	02.03-11.09	62/63/75/77/85/96/120/128/170/173		LAB	0 986 594 504		
	2.0					0 986 594 504 ³		
	2.5 TDI, TDI 4 Motion					0 986 594 504 ⁴		
	3.2, 4 Motion					RAB	0 986 594 505	
							0 986 594 505 ³	
						0 986 594 505 ⁴		

Transporter T5 [7J]



	1.9 TDI	04.03-11.09	62/63/75/77/85/96/128/170		L55	1 987 481 182	558
	2.0						
	2.5 TDI, TDI 4 Motion						

	1.9 TDI	04.03-11.09	62/63/75/77/85/96/128			0 986 473 193	↔ 60	
	2.0					0 986 474 193	↔ 60	
	2.5 TDI							
	2.5 TDI 4 Motion	07.04-11.09	96/128			308	0 986 473 193	↔ 60
							0 986 474 193	↔ 60
						333	0 986 473 181	↔ 59,96
							0 986 474 181	↔ 59,96
	3.2	02.04-11.09	170				0 986 473 181	↔ 59,96
							0 986 474 181	↔ 59,96
	3.2 4 Motion	07.04-11.09	170			308	0 986 473 193	↔ 60
						0 986 474 193	↔ 60	
					333	0 986 473 181	↔ 59,96	
						0 986 474 181	↔ 59,96	



	S							
◀ VW Transporter T5 [7J]								
	1.9 TDI	04.03-11.09	62/63/75/			1987 476 309 ¹	250	
	2.0		77/85/96/			1987 476 310 ²	190	
	2.5 TDI		128					
	2.5 TDI 4 Motion	07.04-11.09	96/128/			1987 476 309 ¹	250	
			170			1987 476 310 ²	190	
				PR-Nr. OWR	LAB	1987 476 313 ²	243	
					RAB	1987 476 320 ²	243	
	3.2	02.04-11.09	96/128/			1987 476 309 ¹	250	
			170			1987 476 310 ²	190	
	3.2 4 Motion	07.04-11.09	96/128/			1987 476 309 ¹	250	
		170			1987 476 310 ²	190		
			PR-Nr. OWR	LAB	1987 476 313 ²	243		
				RAB	1987 476 320 ²	243		
	1.9 TDI	04.03-11.09	62/63/75/					1987 470 040 ⁷
	2.0		77/85/96/					
	2.5 TDI		128					
	2.5 TDI 4 Motion	07.04-11.09	96/128					1987 470 040 ⁷
					294			
					322	0986 473 188	← 44	1987 470 506 ⁸
						0986 474 188	→ 44	1987 470 506 ⁸
	3.2	02.04-11.09	170			0986 473 188	← 44	1987 470 506 ⁸
						0986 474 188	→ 44	1987 470 506 ⁸
	3.2 4 Motion	07.04-11.09	170					1987 470 040 ⁷
				294				
				322	0986 473 188	← 44	1987 470 506 ⁸	
					0986 474 188	→ 44	1987 470 506 ⁸	
	1.9 TDI	04.03-11.09	62/63/75/			0986 480 992	27	
	2.0		77/85/96/					
	2.5 TDI, TDI 4 Motion		128/170					
	3.2, 4 Motion							
	1.9 TDI	04.03-05.06	63	PR-Nr. OE0, PR-Nr. OE9		1987 482 014	↔ 1270	
		04.03-11.09	63	PR-Nr. OE1, PR-Nr. OE2		1987 477 260	↔ 1297	
		06.06-11.09	62	PR-Nr. OE1, PR-Nr. OE2		1987 477 260	↔ 1297	
			75	PR-Nr. OE1, PR-Nr. OE2		1987 477 260	↔ 1297	
	1.9 TDI	04.03-05.06	77/85/96/	PR-Nr. OE0, PR-Nr. OE9		1987 482 014	↔ 1270	
	2.0		128					
	2.5 TDI	04.03-11.09	77/85/96/	PR-Nr. OE1, PR-Nr. OE2		1987 477 260	↔ 1297	
			128					
	2.5 TDI 4 Motion	07.04-11.09	96/128	PR-Nr. OE1		1987 482 016	↔ 1650	
				PR-Nr. OE2		1987 482 015	↔ 2015	
	3.2	02.04-05.06	170	PR-Nr. OE0, PR-Nr. OE9		1987 482 014	↔ 1270	
		02.04-11.09	170	PR-Nr. OE1, PR-Nr. OE2		1987 477 260	↔ 1297	
	3.2 4 Motion	07.04-11.09	170	PR-Nr. OE1		1987 482 016	↔ 1650	
			PR-Nr. OE2		1987 482 015	↔ 2015		
	1.9 TDI	04.03-11.09	62/63/75/		LAB	0986 594 504		
	2.0		77/85/96/		RAB	0986 594 505		

de

Gegenüberstellung**Benutzerhinweise**

Im nachfolgenden Katalogteil sind Bestellnummern von Herstellern anderer Marken, für die es einbaugleiche Bosch-Erzeugnisse oder -Teile gibt, aufgeführt. Da die verschiedenartigsten Bezeichnungssysteme angewendet werden, konnten die fremden Bestellnummern nur in einer einheitlichen, alphanumerischen Sortierfolge geordnet werden. Sie weicht bei einigen Herstellern von der dort üblichen Sortierfolge ab. Eine Rückumschlüsselung von Bosch- zu Fremdnummern ist nicht zulässig.

Hinweis

Aus wettbewerbsrechtlichen Gründen dürfen gegenüber Endkunden zur Kennzeichnung von Bosch-Teilen nur die Bosch-Teilenummern verwendet werden.

en

Cross-reference**Notes for users**

The following catalog section lists part numbers of non-Bosch equipment for which there are interchangeable Bosch products or components available. Since a wide range of different designation systems are used, we were forced to arrange the non-Bosch part numbers in a uniform alphanumerical order. This differs from the customary order employed by some manufacturers. Reconversion of Bosch numbers back to the numbers of other manufacturers is not permitted.

Note

The laws governing competition stipulate that only Bosch type numbers may be used vis-à-vis the final customer for the identification of Bosch parts.

fr

Table de correspondance**A l'attention de l'utilisateur**

Cette section du catalogue reprend les références des fabricants d'autres marques pour lesquelles il existe des produits ou des composants Bosch de montage identique. De multiples systèmes de codage étant utilisés, les références des produits d'autres marques ne peuvent être reprises que suivant un classement alphanumérique uniforme. Pour certains fabricants, ce classement peut différer de celui qu'ils utilisent habituellement. La re-conversion de références Bosch en références d'autres marques n'est pas autorisée.

Remarque

En raison des dispositions légales concernant la concurrence seules les références Bosch peuvent être utilisées vis-à-vis des clients finaux pour l'identification des pièces Bosch.

it

Comparazione**Avvertenze per la consultazione**

Nella seguente parte del catalogo vengono riportati i numeri di ordinazione di costruttori di prodotti d'altra marca, per i quali sono disponibili prodotti o parti di prodotti Bosch di corrispondente applicazione. Dato che vengono utilizzati i più diversi sistemi di denominazione, si è potuto ordinare i numeri di ordinazione di altra marca solo in una sequenza di classificazione unitaria ed alfanumerica. Per alcune case costruttrici si differenzia perciò dalla sequenza di classificazione normalmente usata. In questo confronto le sigle Bosch vanno considerate come dati indicativi. Non è ammessa una ricodificazione da numeri di ordinazione Bosch a numeri di altra marca.

Avvertenza

Per motivi legati ai diritti che regolano la concorrenza, per l'identificazione dei componenti Bosch destinati all'utente finale, possono essere impiegati solo i codici Bosch.

es

Equivalencias**Indicaciones para el usuario**

A continuación se han relacionado números de pedido de fabricantes de otras marcas para los que existen productos o piezas Bosch de iguales características. Dado que se utilizan los más diversos sistemas de designación, los números de pedido ajenos han podido relacionarse tan sólo en un orden unificado, alfanumérico. En el caso de algunos fabricantes, el orden de esta clasificación difiere del que utilizan habitualmente. No es admisible la recodificación de los números de Bosch en números ajenos.

Nota

Por aspectos legales relativos a la competencia, de cara a los clientes finales únicamente deben utilizarse los números de piezas tipo Bosch para identificar piezas Bosch.

60749881	0 204 104 049	71712391	0 265 216 532	7696710	F 026 002 565	790909	0 204 102 447
60749888	0 204 116 113	71712392	0 265 216 534	7696710	0 204 116 454	790910	0 204 102 448
60749889	0 204 116 114	71712393	0 265 216 687	7696710	0 204 116 565	791113	0 204 116 530
60749984	0 204 116 124	71712394	0 265 216 550	7708289	0 204 162 088	791159	F 026 002 470
60749985	0 204 116 125	71712395	0 265 216 552	7710140	0 265 201 054	791159	0 204 116 470
60750112	0 204 122 182	71712397	0 265 216 601	7710976	0 204 125 420	791328	0 204 122 219
60750204	F 026 002 137	71712398	0 265 216 711	7711039	0 204 131 218	791442	0 204 102 428
60750204	0 204 116 137	71712399	0 265 216 572	7713638	0 204 125 416	791443	0 204 102 429
60750205	F 026 002 138	71712401	0 265 216 615	7713643	0 204 125 418	791445	0 204 102 525
60750205	0 204 116 138	71714732	0 265 220 547	7713643	0 204 125 550	791452	0 204 122 256
60750452	0 204 122 164	71714735	0 265 225 032	7713646	0 204 125 422	791458	0 204 131 267
60755049	0 204 102 238	71714735	0 265 225 194	7714822	1 987 477 382	791462	0 204 131 226
60760115	0 986 471 007	71714738	0 265 224 084	7716265	0 204 125 429	791475	0 204 131 227
60760115	0 986 471 027	71715088	0 265 222 029	7731008	0 204 162 093	791811	0 204 131 226
60760116	0 986 471 006	71717166	0 265 216 828	7734997	F 026 002 157	791897	0 204 102 484
60760116	0 986 472 027	71717285	0 265 224 049	77350080	1 987 476 634	791898	0 204 102 485
60760117	0 204 122 192	71717828	0 265 216 709	7735009	1 987 476 635	791899	0 204 102 440
60760126	0 204 122 201	71717851	0 265 225 094	77362106	0 204 125 792	791900	0 204 102 441
60800249	0 204 122 156	71718671	0 265 220 657	77362107	0 204 123 592	791952	0 204 100 392
60801577	F 026 005 580	71718842	0 265 225 143	77362108	0 204 125 791	792040	F 026 003 296
60806216	1 987 476 416	71719580	0 265 224 084	77362164	0 204 024 917	792040	0 204 122 296
60806223	0 204 131 230	71719731	0 265 222 029	77362384	F 026 003 628	792235	0 204 102 443
60806252	0 265 006 212	71719733	0 265 225 194	7740758	F 026 002 178	792235	0 204 102 528
60806254	0 265 006 197	71728319	0 265 216 828	7740758	0 204 116 178	792236	0 204 102 529
60806307	1 987 477 382	7531828	1 987 476 445	7743900	0 204 131 240	792286	0 204 102 447
60806311	1 987 477 382	7532204	1 987 476 445	7747332	1 987 477 384	792287	0 204 102 448
60807521	0 265 201 054	7543163	0 204 125 336	7747954	0 204 125 449	792557	0 204 104 192
60807529	0 265 005 031	7545170	0 204 125 345	7751336	0 204 131 233	792895	F 026 003 296
60808170	0 265 208 034	7563851	1 987 476 445	7754462	0 204 125 602	792895	0 204 122 296
60808316	1 987 477 390	7563852	1 987 476 006	7757585	0 204 125 443	792987	0 204 122 256
60808397	0 265 003 075	7563854	1 987 476 007	7757604	F 026 002 158	793007	0 204 122 225
60809348	F 026 005 092	7570315	1 987 476 244	7757604	0 204 116 158	793010	F 026 003 226
60809348	0 204 162 092	7577466	1 987 476 445	7759266	0 204 125 446	793010	0 204 122 226
60809727	F 026 005 091	7577467	1 987 476 445	7759547	F 026 005 095	793034	0 204 122 230
60809897	F 026 005 095	7586907	1 987 476 629	7773015	1 987 482 177	793039	0 204 122 230
60809966	F 026 002 158	7590581	1 987 476 630	7773019	1 987 482 178	793047	0 204 123 458
60809966	0 204 116 158	7592743	0 204 125 348	790137	0 204 123 233	793053	0 204 122 230
60811672	0 265 208 034	7598922	0 204 125 359	790204	0 204 122 256	793060	0 204 102 460
60811771	F 026 005 581	7602061	0 204 125 362	790205	0 986 480 654	793061	0 204 102 461
60812073	0 204 125 431	7603330	1 987 476 006	790215	0 986 475 273	793189	0 204 122 236
60812250	1 987 476 639	7613939	0 265 208 034	790329	0 204 102 604	793190	0 204 122 237
60812266	0 204 163 079	76139390	0 265 201 024	790330	0 204 102 424	793193	0 204 122 256
60812394	0 265 006 212	7615343	1 987 477 376	790332	0 204 102 424	793234	0 204 122 219
60812395	0 265 006 162	7619751	1 987 476 633	790606	0 204 123 458	793266	F 026 003 243
60813773	0 265 006 238	7630317	0 265 001 215	790608	0 204 122 230	793266	0 204 122 243
60814827	F 026 005 095	7635376	1 987 476 631	790610	F 026 002 527	793290	0 204 122 245
60815246	F 026 005 580	7651142	F 026 003 430	790610	0 204 116 527	793307	0 204 122 256
66564165	0 265 208 027	7651142	0 204 123 430	790616	F 026 002 453	793309	0 204 122 297
7032156	0 204 122 156	7661241	1 987 477 091	790833	F 026 002 454	793332	0 204 122 258
7074619	0 986 480 656	7663039	1 987 476 632	790833	F 026 002 565	793438	F 026 002 457
71711253	0 265 216 402	7667806	1 987 476 633	790833	0 204 116 454	793438	0 204 116 457
71711893	0 265 216 504	7674977	1 987 476 749	790833	0 204 116 565	793439	F 026 002 458
71712386	0 265 216 677	7692964	F 026 003 430	790837	0 204 122 230	793439	0 204 116 458
71712387	0 265 216 436	7692964	0 204 123 430	790838	0 204 122 230	793764	0 204 102 605
71712390	0 265 216 530	7696710	F 026 002 454	790860	0 204 122 256	793770	0 204 102 471

◀ ALFA ROMEO

793771	0 204 102 472	82472243	0 265 006 197	9945379	F 026 002 565	9947060	0 204 102 529
793790	0 204 102 475	82473716	1 987 476 861	9945379	0 204 116 454	9947061	0 204 102 566
793791	0 204 102 476	82473717	1 987 476 862	9945379	0 204 116 565	9947062	0 204 102 567
793962	0 204 122 261	82474881	0 265 208 034	9945736	0 986 471 010	9947063	0 204 102 526
794099	0 204 104 198	82475526	0 204 125 433	9945737	0 986 471 009	9947064	0 204 102 527
794352	0 204 102 484	91373865	0 204 125 357	9945753	0 204 125 440	9947098	F 026 003 266
794353	0 204 102 485	9566949780	F 026 002 181	9945754	0 204 125 423	9947098	0 204 122 266
82303072	0 204 104 219	9566949780	0 204 116 181	9945755	F 026 003 194	9947099	0 204 122 267
82369266	0 204 122 147	9567205280	0 204 125 715	9945755	0 204 122 194	9947109	0 204 102 562
82383798	1 987 476 503	9567205380	F 026 003 166	9945757	0 204 122 265	9947110	0 204 102 563
82384952	1 987 476 503	9567205380	0 204 123 166	9945760	0 204 122 268	9947111	0 204 102 526
82388503	0 204 131 196	9567205480	0 204 123 182	9945761	0 204 125 444	9947111	0 204 102 542
82390661	1 987 476 641	9936496	0 204 116 461	9945767	0 204 122 264	9947112	0 204 102 543
82392239	1 987 476 640	9937663	0 204 125 298	9945768	0 204 125 449	9947121	0 204 102 502
824012520	0 265 001 073	9937665	F 026 003 150	9945824	0 204 125 426	9947121	0 204 902 103
824012530	0 265 201 016	9938110	0 204 104 038	9945910	0 986 475 056	9947122	0 204 102 503
82401754	1 987 476 239	9938829	F 026 003 150	9945939	0 986 475 612	9947122	0 204 902 104
82407500	1 987 476 641	9938868	0 986 475 420	9946019	0 204 102 526	9947128	0 204 102 506
82407501	1 987 476 643	9939674	0 204 125 331	9946019	0 204 102 542	9947129	0 204 102 507
824076790	0 265 001 074	9939698	0 986 471 776	9946020	0 204 102 527	9947161	F 026 002 434
82407928	1 987 476 642	9939699	0 986 471 777	9946020	0 204 102 543	9947161	0 204 116 434
82416097	1 987 477 388	9939963	0 204 122 181	9946047	0 204 125 445	9947393	0 204 102 575
82422138	1 987 476 640	9940066	0 986 471 014	9946048	0 204 123 320	9947394	0 204 102 576
82422139	1 987 476 759	9940069	0 986 471 013	9946055	F 026 003 318	9947449	0 204 125 441
82422141	1 987 476 641	9940554	0 986 475 420	9946055	0 204 123 318	9948005	1 460 491 300
82422142	1 987 476 642	9940558	0 986 475 612	9946056	F 026 003 313	9948107	0 204 102 822
82422143	1 987 476 641	9940564	0 986 471 779	9946056	0 204 123 313	9948110	0 204 102 823
82422144	1 987 476 643	9940567	0 986 471 778	9946102	0 204 102 492	9948124	0 204 102 847
824346980	0 265 100 042	9940972	0 204 122 185	9946103	0 204 102 494	9948195	F 026 002 558
824346990	0 265 105 035	9941101	0 204 125 362	9946106	0 204 102 493	9948195	0 204 116 558
82434700	0 265 005 030	9941368	F 026 003 328	9946107	0 204 102 495	9948204	0 204 902 107
82434701	0 332 512 009	9941368	0 204 123 328	9946108	0 204 104 204	9948208	0 204 902 108
824350910	0 265 201 033	9941536	0 204 125 369	9946114	0 204 102 620	9948230	0 204 102 854
824356600	0 265 001 248	9941666	0 986 472 826	9946172	0 204 102 540	9948325	0 204 123 524
824356610	0 265 001 249	9941667	0 986 472 827	9946172	0 204 102 605	9948414	0 204 105 004
824356620	0 265 001 246	9942013	0 986 471 007	9946180	0 204 102 448	9948578	0 204 125 728
824356630	0 265 001 247	9942013	0 986 471 027	9946182	0 204 102 447	9948580	0 204 123 532
82441688	1 987 477 389	9942014	0 986 471 006	9946385	F 026 003 150	9948586	0 204 123 533
824427230	0 265 001 209	9942014	0 986 472 027	9946624	0 986 480 687	9948636	0 204 125 730
82442897	0 204 162 081	9942427	0 986 475 056	9946638	0 204 123 314	9948877	F 026 003 313
82443349	0 204 125 389	9942902	0 986 472 826	9946751	0 204 123 319	9948877	0 204 123 313
82444381	0 986 471 007	9942903	0 986 472 827	9946798	0 204 122 270	9948882	F 026 003 315
82444381	0 986 471 027	9942991	0 204 125 371	9946800	F 026 003 315	9948882	0 204 123 315
82444382	0 986 471 006	9943323	F 026 003 262	9946800	0 204 123 315	9949164	0 204 125 772
82444382	0 986 472 027	9943323	0 204 122 262	9946828	0 204 102 532	9949348	0 204 001 969
824484640	0 265 001 304	9943705	0 204 122 195	9946829	0 204 102 533	9949546	F 026 003 603
82450141	0 265 005 031	9943706	0 204 125 409	9946893	0 204 102 532	9949546	0 204 123 603
824501410	0 265 005 031	9944331	0 204 125 417	9946894	0 204 102 533	9949548	F 026 003 604
82451414	0 204 125 398	9944381	0 204 125 372	9946899	0 204 102 525	9949615	0 204 123 620
82455793	0 204 131 212	9944382	0 204 122 203	9947029	0 204 102 540	9949617	0 204 125 803
82458587	0 265 006 212	9944493	0 204 102 443	9947030	0 204 102 541	9950173	0 204 122 195
824585870	0 265 003 074	9944493	0 204 102 528	9947049	0 204 102 499	9950437	0 986 471 010
824585870	0 265 006 212	9944494	0 204 104 234	9947050	0 204 102 500	9950438	0 986 471 009
82461790	0 265 208 034	9944497	0 204 102 529	9947050	0 204 902 102	9950477	0 986 472 826
82466903	0 204 125 419	9945379	F 026 002 454	9947059	0 204 102 528	9950478	0 986 472 827

9950489	0 204 104 234
9950501	0 204 102 620
9950504	0 204 102 433
9950504	0 204 102 532
9950602	0 204 102 532

9950603	0 204 102 533
9950604	0 204 102 532
9950605	0 204 102 533
9950645	0 204 102 506
9950646	0 204 102 507

9950677	0 204 122 268
9950806	0 204 102 502
9950806	0 204 902 103
9950809	0 204 102 503
9950809	0 204 902 104

9950817	F 026 002 434
9950817	0 204 116 434
9951096	0 204 902 107
9951096	0 204 902 108
9951099	0 204 902 108

9951111	0 204 102 847
9983471	0 986 475 826

BEDFORD

02696472	0 986 475 815
2696482	0 986 475 832
2696483	0 986 475 831

91 023 391	0 986 475 823
94 222 685	1 987 476 549
94 230 541	0 986 475 807
94 316 795	1 987 476 550
99 59 752	1 987 476 579

CHEVROLET

09 120 525	0 265 216 652
09 120 534	0 265 220 458
09 127 787	1 987 477 668

09 193 487	0 265 216 479
14104821 C	0 265 001 228
14104822 C	0 265 001 227
426503	0 986 480 996
90 147 349	1 987 476 408

93 233 386	0 204 032 367
93 233 867	0 204 072 180
93 233 868	0 204 072 181
93 268 022	0 204 0A2 185
93 278 485	0 204 0A2 188

93 294 647	0 265 006 488
93 314 859	0 204 022 912
93 326 232	0 204 222 658
93 326 547	0 204 022 355
93 326 548	0 204 022 353

93 336 202	0 204 222 726
93 377 375	0 204 0A2 422
93 380 777	0 204 032 789
96 320 670	0 986 475 889
96 482 028	1 987 477 718

96 518 606	0 986 475 889
96 534 870	1 987 482 082
96 534 871	1 987 482 083

CITROEN

AMN 453 032	0 204 116 301
AMN 453 05	0 986 475 590
AM 453 010 A	0 204 116 035

AM 453 03 A	0 204 122 007
AM 453 03 G	0 204 122 023
AM 453 04 B	0 204 116 031
AM 453 05 A	0 204 116 085
AZ 453 05	0 204 116 011

AZ 4530 5C	0 204 116 466
DXN 453 05	0 204 116 468
GX 422 5402 A	1 987 477 075
HY 456 37	0 204 131 007
V7 552 114	0 261 231 197

ZF 04 450 938	1 987 477 515
ZF 05 952 297	1 987 476 548
ZF 07 567 861	1 987 476 462
ZF 07 567 862	1 987 476 463
ZF 09 937 665	F 026 003 150

ZF 09 937 665	0 204 122 150
ZF 09 938 829	F 026 003 150
ZF 09 938 829	0 204 122 150
ZF 09 938 868	0 986 475 420
ZF 09 942 427	0 986 475 056

12 959 200	0 204 163 006
13 228 200	0 204 162 013
13 48 980 080	1 987 482 214
13 533 600	0 204 162 018
1354 55	F 026 002 506

1354 55	0 204 116 506
1354 57	0 986 475 230
13 896 800	0 204 131 103
14 769 310	0 204 131 085
14 888 410	0 265 007 083

14 916 620	0 265 006 731
1646 37	0 204 162 020
16 939 800	0 204 162 022
17 473 700	0 204 123 022
17 511 000	0 204 116 090

17 671 900	0 204 123 469
1768 00	0 986 475 230
1920 FR	0 261 231 168
1920 LT	0 261 231 197
2086 01	0 204 163 015

2086 02	0 204 163 016
2086 04	F 026 005 517
2086 06	0 204 163 019
2086 07	0 204 163 019
2086 08	F 026 005 517

2086 10	0 204 163 020
2086 12	0 204 163 007
2086 16	0 204 163 014
2095 11	0 204 162 006
2095 12	0 204 162 004

2095 13	0 204 162 008
2095 14	0 204 162 015
2095 16	0 204 162 026
2095 18	0 204 162 029
25 568 000	0 204 131 032

40 33 119 720	0 204 123 227
42 254 02A	1 987 477 075
4242 A4	0 265 109 089
43 216 000	0 204 162 031
43 248 600	0 204 104 034

43 255 500	0 204 104 035
4400 A3	0 986 471 869
4400 A4	0 986 471 870
4400 C2	0 204 102 267
4400 C3	0 204 102 268

4400 C4	0 986 471 885
4400 C5	0 986 471 886
4400 C8	0 204 102 281
4400 C9	0 204 102 282
4400 E4	0 986 471 887

4400 E5	0 986 471 888
4400 E6	0 204 102 267
4400 E7	0 204 102 268
4400 F2	0 204 102 287
4400 F3	0 204 102 288

4400 F4	0 204 102 289
4400 F5	0 204 102 290
4400 F7	0 204 102 521
4400 F7	0 204 205 235
4400 F8	0 204 102 523

4400 F8	0 204 205 236
4400 F9	0 986 471 885
4400 G0	0 986 471 886
4400 G1	0 204 102 228
4400 G2	0 204 102 229

4400 G5	0 986 471 024
4400 G5	0 986 471 869
4400 G6	0 986 471 023
4400 G6	0 986 471 870
4400 G7	0 986 471 887

4400 G8	0 986 471 888
4400 H1	0 204 102 186
4400 H2	0 204 102 188
4400 H3	0 204 102 190
4400 H4	0 204 102 192

4400 H5	0 204 102 194
4400 H6	0 204 102 196
4400 J0	0 204 102 594
4400 J1	0 204 102 595
4400 J2	0 204 102 609

4400 J3	0 204 102 610
4400 J4	0 986 471 887
4400 J5	0 986 471 888
4400 J6	0 204 102 647
4400 J7	0 204 102 648

4400 K1	0 204 102 289
4400 K2	0 204 102 290
4400 K3	0 204 102 751
4400 K4	0 204 102 752
4400 K5	0 204 102 759

4400 K6	0 204 102 760
4400 K7	0 204 102 763
4400 K8	0 204 102 764
4400 K9	0 986 471 885
4400 L0	0 986 471 886

4400 L4	0 204 102 961
4400 L5	0 204 102 962
4400 L6	0 204 102 963
4400 L7	0 204 102 964
4400 L8	0 204 102 965

4400 L9	0 204 102 966
4400 N0	0 204 102 971
4400 N1	0 204 102 972
4400 N8	0 204 102 989
4400 N9	0 204 102 990

4400 P0	0 204 102 991
4400 P1	0 204 102 992
4400 P2	0 204 102 993
4400 P3	0 204 102 994
4400 R4	0 204 205 113

4400 R5	0 204 205 114
4400 R6	0 204 004 451
4400 R7	0 204 004 452
4400 R8	0 204 004 449
4400 R9	0 204 004 450

4400 T0	0 204 205 740
4400 T1	0 204 205 741
4400 T7	0 204 207 082
4400 T8	0 204 207 083
4400 68	0 204 102 226

4400 69	0 204 102 227
4400 75	0 204 102 224
4400 76	0 204 102 225
4400 83	0 986 471 672
4400 84	0 986 472 672

4400 85	0 986 471 776
4400 86	0 986 471 777
4400 89	0 204 102 228
4400 90	0 204 102 229
4400 91	0 986 471 778

◀ CITROEN

4400 92	0 986 471 779	4402 E0	0 204 116 536	4402 74	F 026 002 521	4535 A6	0 204 125 104
4400 93	0 204 102 241	4402 E1	0 986 475 907	4402 74	0 204 116 521	4535 A9	0 204 125 079
4400 93	0 204 102 289	4402 E2	0 986 475 908	4402 75	0 986 475 513	4535 CJ	0 204 125 942
4400 94	0 204 102 242	4402 E3	0 986 475 909	4402 76	0 986 475 842	4535 CK	0 204 125 944
4400 94	0 204 102 290	4402 E4	0 986 475 906	4402 77	F 026 002 135	4535 CL	0 204 125 943
4401 A2	0 204 102 277	4402 E6	0 204 011 463	4402 77	0 204 116 135	4535 CN	0 204 125 945
4401 A3	0 204 102 278	4402 F0	0 204 116 607	4402 78	F 026 002 136	4535 C8	0 204 125 445
4401 G8	0 204 004 330	4402 F1	0 204 214 282	4402 78	0 204 116 136	4535 C9	0 204 125 746
4401 G9	0 204 004 331	4402 F9	0 204 011 407	4402 79	F 026 002 176	4535 E1	0 204 125 134
4401 N8	0 204 902 044	4402 09	F 026 002 006	4402 79	0 204 116 127	4535 E2	0 204 125 714
4401 N9	0 204 902 045	4402 14	0 204 116 014	4402 79	0 204 116 176	4535 E3	0 204 125 715
4401 49	0 204 102 017	4402 28	F 026 002 037	4402 79	0 204 116 390	4535 E4	0 204 125 109
4401 50	0 204 102 019	4402 29	0 204 116 038	4402 80	F 026 002 177	4535 E5	0 204 125 716
4401 50	0 204 102 654	4402 32	0 204 116 047	4402 80	0 204 116 126	4535 E6	0 986 485 104
4401 57	0 204 102 231	4402 34	0 204 116 039	4402 80	0 204 116 177	4535 E7	0 986 485 105
4401 58	0 204 102 232	4402 37	0 204 116 078	4402 81	0 986 475 612	4535 F0	0 204 125 079
4401 59	0 204 102 233	4402 38	F 026 002 053	4402 82	F 026 002 208	4535 F3	0 204 125 139
4401 60	0 204 102 234	4402 39	0 204 116 097	4402 82	0 204 116 208	4535 F4	0 204 125 145
4401 61	0 204 102 075	4402 40	0 204 116 096	4402 83	F 026 002 209	4535 F5	0 204 125 141
4401 62	0 204 102 077	4402 41	F 026 002 091	4402 83	0 204 116 209	4535 F6	0 204 125 143
4401 63	0 986 471 659	4402 41	0 204 116 091	4402 84	0 204 116 023	4535 F7	0 204 125 485
4401 64	0 986 472 659	4402 42	F 026 002 092	4402 85	0 986 475 056	4535 F8	0 204 125 484
4401 64	0 986 472 677	4402 42	0 204 116 092	4402 86	0 986 475 619	4535 G0	0 204 125 094
4401 67	0 986 471 691	4402 43	0 204 116 095	4402 87	0 986 475 620	4535 H0	0 204 125 514
4401 68	0 986 472 691	4402 44	F 026 002 507	4402 88	F 026 002 216	4535 H4	0 204 125 216
4401 70	0 986 471 666	4402 44	0 986 475 230	4402 88	0 204 116 216	4535 H5	0 204 125 514
4401 71	0 986 472 666	4402 47	0 986 475 233	4402 89	F 026 002 217	4535 J1	0 204 125 604
4401 72	0 986 471 683	4402 48	0 986 475 234	4402 89	0 204 116 217	4535 J2	0 204 125 605
4401 73	0 986 472 683	4402 49	0 986 475 231	4402 90	F 026 002 228	4535 J5	0 204 125 139
4402 A0	0 986 475 636	4402 50	F 026 002 093	4402 90	0 204 116 228	4535 J6	0 204 125 141
4402 A1	0 986 475 635	4402 50	0 204 116 093	4402 91	F 026 002 229	4535 K0	0 204 125 743
4402 A2	0 204 116 179	4402 52	0 986 475 781	4402 91	0 204 116 229	4535 K2	0 204 125 744
4402 A3	0 986 475 802	4402 54	0 204 116 514	4402 92	F 026 002 175	4535 K3	0 204 125 734
4402 A4	0 986 475 801	4402 55	F 026 002 088	4402 92	0 204 116 175	4535 K4	0 204 125 748
4402 A5	0 986 475 803	4402 55	0 204 116 088	4402 93	F 026 002 222	4535 K5	0 204 125 749
4402 A6	0 986 475 796	4402 56	F 026 002 110	4402 93	0 204 116 222	4535 K6	0 204 125 751
4402 A7	F 026 002 181	4402 56	0 204 116 110	4402 94	F 026 002 223	4535 K7	0 204 125 750
4402 A7	0 204 116 181	4402 57	0 986 475 428	4402 94	0 204 116 223	4535 L4	0 204 125 772
4402 A8	0 986 475 797	4402 59	0 986 475 512	4402 95	F 026 002 128	4535 L6	0 204 125 773
4402 C1	F 026 002 183	4402 62	F 026 002 506	4402 95	0 204 116 128	4535 L7	0 204 125 776
4402 C1	0 204 116 183	4402 62	0 204 116 506	4402 97	F 026 002 234	4535 L8	0 204 125 777
4402 C2	F 026 002 184	4402 63	F 026 002 087	4402 97	0 204 116 226	4535 L9	0 204 125 779
4402 C2	0 204 116 184	4402 63	0 204 116 087	4402 97	0 204 116 234	4535 N0	0 204 125 780
4402 C3	0 986 475 797	4402 63	0 986 475 209	4402 98	F 026 002 235	4535 N5	0 204 125 792
4402 C4	F 026 002 244	4402 65	F 026 002 204	4404 06	0 204 102 091	4535 N6	0 204 125 791
4402 C4	0 204 116 244	4402 65	0 204 116 204	4439 22	0 204 100 377	4535 R0	0 204 125 801
4402 C5	F 026 002 245	4402 66	F 026 002 205	4448 22	0 204 104 025	4535 R4	0 204 125 804
4402 C5	0 204 116 245	4402 66	0 204 116 205	4448 31	0 204 104 027	4535 R5	0 204 125 805
4402 C6	0 986 475 836	4402 67	F 026 002 216	4448 37	0 204 104 063	4535 R7	0 204 125 035
4402 C7	F 026 002 471	4402 67	0 204 116 202	4448 60	0 204 104 070	4535 T7	0 204 125 822
4402 C7	0 204 116 471	4402 68	F 026 002 217	4448 61	0 204 104 049	4535 T8	0 204 125 821
4402 C8	0 986 475 833	4402 68	0 204 116 203	4448 63	0 204 104 068	4535 T9	0 204 125 820
4402 C9	F 026 002 535	4402 70	0 986 475 420	4535 AA	0 204 125 901	4535 V0	0 204 125 823
4402 C9	0 204 116 535	4402 73	F 026 002 520	4535 AC	0 204 125 902	4535 V5	0 204 125 831
4402 E0	F 026 002 536	4402 73	0 204 116 520	4535 A4	0 204 125 420	4535 V6	0 204 125 830

4535 Y7	0 204 125 837	4541 J5	0 265 231 523	4542 22	2 267 000 724	4545 28	0 265 003 100
4535 49	0 204 125 009	4541 K5	0 265 234 461	4542 22	2 267 000 735	4545 28	0 265 003 124
4535 53	0 204 125 015	4541 K7	0 265 234 053	4542 27	2 267 000 735	4545 28	0 265 006 315
4535 61	0 204 125 016	4541 K8	0 265 234 459	4542 34	2 267 000 740	4545 31	0 265 003 099
4535 64	0 204 125 508	4541 L7	0 265 234 061	4542 36	1 267 000 821	4545 31	0 265 006 201
4535 66	0 204 125 020	4541 L8	0 265 235 011	4542 43	1 267 000 828	4545 32	0 265 006 200
4535 67	0 204 125 298	4541 08	0 265 208 305	4542 50	2 267 000 740	4545 33	0 265 003 079
4535 68	0 204 125 042	4541 11	0 265 201 058	4542 54	2 267 000 735	4545 33	0 265 003 129
4535 70	0 204 125 042	4541 12	0 265 201 056	4542 57	1 267 000 821	4545 33	0 265 006 202
4535 71	0 204 125 019	4541 13	0 204 153 012	4542 61	0 265 109 415	4545 34	0 265 006 204
4535 75	0 204 125 328	4541 17	0 265 208 321	4542 66	0 265 109 432	4545 35	0 265 003 128
4535 81	0 204 125 058	4541 18	0 265 211 008	4542 67	0 265 109 089	4545 35	0 265 006 199
4535 82	0 204 125 059	4541 23	0 265 216 303	4542 67	0 265 109 414	4545 36	0 265 003 129
4535 83	0 204 125 345	4541 25	0 265 216 340	4542 69	0 265 109 089	4545 36	0 265 006 202
4535 84	0 986 485 097	4541 31	0 265 216 342	4542 69	0 265 109 414	4545 37	0 265 003 123
4535 86	0 204 125 084	4541 33	0 265 216 341	4542 70	0 265 109 089	4545 37	0 265 006 314
4535 88	0 204 125 082	4541 34	0 265 216 483	4542 89	0 265 109 089	4545 44	0 265 006 201
4535 9A	0 204 125 094	4541 35	0 265 216 484	4545 A4	0 265 006 732	4545 45	0 265 006 200
4535 94	0 204 125 094	4541 36	0 265 216 496	4545 A8	0 265 006 793	4545 46	0 265 006 202
4535 96	0 204 125 421	4541 38	0 265 216 554	4545 C2	0 265 007 664	4545 47	0 265 006 199
4535 97	0 204 125 418	4541 39	0 265 216 482	4545 C3	0 265 007 780	4545 48	0 265 006 205
4535 97	0 204 125 550	4541 40	0 265 216 436	4545 C4	0 265 007 779	4545 49	0 265 006 206
4541 A2	0 265 234 141	4541 41	0 265 216 530	4545 C7	0 265 007 665	4545 50	0 265 006 203
4541 A3	0 265 231 303	4541 44	0 265 216 641	4545 C8	0 265 007 666	4545 51	0 265 006 204
4541 A3	0 265 231 477	4541 45	0 265 216 544	4545 C9	0 265 007 668	4545 54	0 986 594 021
4541 A9	0 265 225 189	4541 46	0 265 216 699	4545 E0	0 265 007 667	4545 55	0 265 006 207
4541 C4	0 265 231 477	4541 48	0 265 216 605	4545 E1	0 265 007 687	4545 56	0 265 006 202
4541 C5	0 265 225 166	4541 49	0 265 202 419	4545 E2	0 265 007 688	4545 56	0 265 006 208
4541 C7	0 265 225 128	4541 50	0 265 216 643	4545 E3	0 265 005 486	4545 57	0 986 594 020
4541 C8	0 265 225 159	4541 51	0 265 216 721	4545 E5	0 265 007 707	4545 60	0 265 006 314
4541 EH	0 265 234 213	4541 52	0 265 216 725	4545 E6	0 265 007 883	4545 61	0 265 006 315
4541 EQ	0 265 230 078	4541 53	0 265 216 723	4545 E7	0 265 007 788	4545 62	0 265 006 209
4541 ET	0 265 231 975	4541 56	0 265 216 758	4545 E8	0 265 007 789	4545 66	0 265 006 389
4541 EW	0 265 235 362	4541 57	0 265 225 038	4545 E9	0 265 007 790	4545 67	0 265 006 388
4541 E2	0 265 234 053	4541 57	0 265 225 164	4545 F0	0 265 007 791	4545 68	0 265 006 426
4541 E3	0 265 231 487	4541 58	0 265 222 010	4545 F6	0 265 008 017	4545 69	0 265 006 441
4541 E4	0 265 234 145	4541 59	0 265 225 104	4545 F7	0 265 008 018	4545 70	0 265 006 427
4541 E8	0 265 231 523	4541 59	0 265 225 166	4545 F8	0 265 008 018	4545 71	0 265 006 405
4541 E9	0 265 234 061	4541 60	0 265 225 128	4545 F9	0 265 005 486	4545 72	0 265 006 406
4541 FQ	0 265 231 797	4541 61	0 265 231 303	4545 H7	0 265 008 018	4545 74	0 986 594 019
4541 F0	0 265 231 565	4541 61	0 265 231 477	4545 H8	0 265 005 517	4545 75	0 265 006 504
4541 F5	0 265 231 580	4541 62	0 265 216 863	4545 J8	0 265 008 485	4545 76	0 986 594 022
4541 F7	0 265 234 153	4541 66	0 265 216 544	4545 11	0 265 003 064	4545 78	0 265 006 389
4541 GQ	0 265 231 975	4541 70	0 265 225 164	4545 12	0 265 003 065	4545 82	0 265 006 544
4541 GT	0 265 235 362	4541 72	0 265 225 164	4545 21	0 265 003 072	4545 83	0 265 006 545
4541 GW	0 265 232 349	4541 76	0 265 225 159	4545 21	0 265 003 126	4545 84	0 265 005 404
4541 G9	0 265 234 141	4541 77	0 265 225 189	4545 21	0 265 006 207	4545 85	0 265 006 659
4541 HX	0 265 230 492	4541 94	0 265 231 303	4545 22	0 265 003 073	4545 88	0 265 007 423
4541 H8	0 265 234 038	4541 94	0 265 231 477	4545 22	0 265 003 127	4545 89	0 265 007 424
4541 H9	0 265 234 153	4541 96	0 265 225 216	4545 22	0 265 006 208	4545 92	0 265 006 730
4541 JP	0 265 232 393	4541 97	0 265 225 130	4545 23	0 265 003 080	4545 93	0 265 006 731
4541 J1	0 265 231 487	4541 99	0 265 225 189	4545 23	0 265 003 123	4545 94	0 265 007 083
4541 J2	0 265 234 053	4542 10	0 265 100 066	4545 23	0 265 006 314	4545 95	0 265 007 084
4541 J3	0 265 234 153	4542 11	0 265 100 073	4545 25	0 265 005 111	4549 05	0 265 005 211
4541 J4	0 265 234 396	4542 18	0 265 100 073	4545 27	0 204 150 083	4549 05	0 265 005 290

◀ CITROEN

4549 07	0 265 005 290	4601 E9	F 026 003 192	4601 L6	0 204 123 592	4601 85	F 026 003 180
4549 16	0 265 005 290	4601 E9	0 204 123 192	4601 L9	0 986 480 879	4601 85	0 204 123 180
4549 17	0 265 005 606	4601 F0	F 026 003 207	4601 N5	0 204 123 616	4601 87	F 026 003 075
4549 21	0 265 005 715	4601 F0	0 204 123 207	4601 N6	0 204 123 615	4601 87	0 204 123 075
4549 26	0 265 005 714	4601 F1	F 026 003 342	4601 N9	0 204 123 546	4601 88	F 026 003 150
4549 27	0 265 005 292	4601 F1	0 204 123 342	4601 P0	0 204 123 584	4601 88	0 204 122 150
4549 27	0 265 005 715	4601 F2	F 026 003 208	4601 P5	F 026 003 633	4601 90	0 204 123 160
4549 28	0 265 005 629	4601 F2	0 204 123 208	4601 P5	0 204 123 633	4601 93	0 204 123 094
4549 28	0 265 005 724	4601 F4	F 026 003 342	4601 P8	0 204 123 644	4601 94	F 026 003 096
4549 33	0 265 005 629	4601 F4	0 204 123 342	4601 P9	0 204 123 645	4601 94	F 026 003 180
4549 33	0 265 005 724	4601 F5	F 026 003 349	4601 R0	0 204 123 653	4601 95	0 986 480 906
4549 39	0 265 005 714	4601 F5	0 204 123 349	4601 R3	0 204 123 667	4601 97	F 026 003 103
4549 43	0 265 005 724	4601 F6	0 204 123 350	4601 R4	0 204 123 666	4601 98	F 026 003 142
4599 15	0 204 120 018	4601 F8	0 986 480 939	4601 T2	0 204 123 746	4601 98	0 204 123 142
4599 21	0 204 120 023	4601 F9	F 026 003 502	4601 T5	0 204 123 747	4633 A4	0 204 124 144
4601 A1	F 026 003 518	4601 F9	0 204 123 502	4601 V0	0 204 123 737	4633 31	0 204 124 006
4601 A2	F 026 003 103	4601 G0	F 026 003 342	4601 V1	0 204 123 736	4649 28	0 265 005 629
4601 A3	F 026 003 243	4601 G0	0 204 123 342	4601 W6	0 204 123 787	4649 28	0 265 005 724
4601 A3	0 204 122 243	4601 G0	0 986 480 663	4601 W7	0 204 123 786	4745 A0	1 987 477 432
4601 A4	0 986 480 912	4601 G1	F 026 003 190	4601 W8	0 204 123 809	4745 A1	1 987 477 431
4601 A6	0 204 123 160	4601 G1	0 204 123 190	4601 W9	0 204 123 813	4745 A2	1 987 477 432
4601 A7	F 026 003 168	4601 G2	0 204 123 343	4601 X0	0 204 123 811	4745 A4	1 987 477 434
4601 A7	0 204 123 168	4601 G3	0 204 123 344	4601 X1	0 204 123 815	4745 A5	1 987 477 435
4601 A8	F 026 003 170	4601 G4	0 204 123 341	4601 12	0 204 122 008	4745 E8	1 987 477 436
4601 A8	0 204 123 170	4601 H4	F 026 003 180	4601 18	0 204 122 028	4745 E9	1 987 477 565
4601 A9	0 204 123 172	4601 H4	0 204 123 180	4601 20	0 204 122 011	4745 F0	1 987 477 566
4601 C0	F 026 003 174	4601 H5	0 986 480 854	4601 23	0 204 122 029	4745 F1	1 987 477 567
4601 C0	0 204 123 174	4601 H8	F 026 003 180	4601 26	0 204 123 001	4745 F2	1 987 477 568
4601 C1	F 026 003 168	4601 H8	0 204 123 180	4601 27	0 204 122 021	4745 F3	1 987 477 569
4601 C1	0 204 123 168	4601 H9	0 204 123 373	4601 40	0 204 122 035	4745 F4	1 987 477 525
4601 C1	0 986 480 898	4601 J2	F 026 003 419	4601 45	0 204 122 029	4745 F5	1 987 477 524
4601 C2	F 026 003 170	4601 J2	0 204 123 419	4601 48	F 026 003 025	4745 F7	1 987 477 437
4601 C2	0 204 123 170	4601 J3	F 026 003 502	4601 48	0 204 123 025	4745 F8	1 987 477 079
4601 C4	0 204 123 162	4601 J3	0 204 123 502	4601 50	0 204 123 056	4745 F9	1 987 477 078
4601 C8	F 026 003 318	4601 J4	F 026 003 501	4601 51	0 204 123 037	4745 G0	1 987 477 438
4601 C8	0 204 123 318	4601 J4	0 204 123 501	4601 52	0 204 123 055	4745 G1	1 987 477 323
4601 C9	0 204 123 319	4601 J7	F 026 003 512	4601 53	0 204 122 045	4745 G2	1 987 477 114
4601 D0	0 204 123 320	4601 J7	0 204 123 512	4601 57	0 204 123 051	4745 G3	1 987 477 113
4601 D1	F 026 003 313	4601 J8	0 204 123 511	4601 60	0 204 122 047	4745 G4	1 987 482 046
4601 D1	0 204 123 313	4601 J9	F 026 003 188	4601 65	F 026 003 057	4745 G5	1 987 477 439
4601 D2	0 204 123 314	4601 J9	0 204 123 519	4601 65	0 204 123 057	4745 G6	1 987 477 440
4601 D3	F 026 003 315	4601 K0	F 026 003 518	4601 71	F 026 003 054	4745 G7	1 987 477 115
4601 D3	0 204 123 315	4601 K0	0 204 123 518	4601 71	0 204 123 054	4745 G8	1 987 477 773
4601 E0	0 204 123 186	4601 K1	F 026 003 517	4601 72	0 204 123 053	4745 G9	1 987 477 568
4601 E1	F 026 003 166	4601 K1	0 204 123 517	4601 73	0 204 122 273	4745 H4	1 987 477 573
4601 E1	0 204 123 166	4601 K2	F 026 003 516	4601 76	F 026 003 058	4745 H5	1 987 477 441
4601 E2	0 204 123 182	4601 K2	0 204 123 516	4601 76	0 204 123 058	4745 H7	1 987 477 442
4601 E3	F 026 003 188	4601 K3	0 204 123 545	4601 78	0 204 123 001	4745 H8	1 987 477 574
4601 E3	0 204 123 188	4601 K4	0 204 123 544	4601 80	F 026 003 064	4745 J0	1 987 477 576
4601 E4	F 026 003 518	4601 K5	0 204 123 536	4601 80	0 204 123 064	4745 J2	1 987 482 005
4601 E6	F 026 003 315	4601 L0	0 204 123 597	4601 82	0 204 122 044	4745 J3	1 987 477 577
4601 E6	0 204 123 315	4601 L1	0 204 123 598	4601 83	F 026 003 150	4745 J5	1 987 477 440
4601 E7	0 204 123 325	4601 L2	0 204 123 596	4601 83	0 204 122 150	4745 J8	1 987 477 580
4601 E8	F 026 003 190	4601 L3	0 204 123 595	4601 84	F 026 003 033	4745 J9	1 987 477 581
4601 E8	0 204 123 190	4601 L5	0 986 480 876	4601 84	0 204 123 033	4745 K0	1 987 477 582

4745 K1	1987 477 583	4745 Z3	1987 477 235	4806 C7	1987 481 002	4806 75	1987 476 148
4745 K2	1987 477 584	4745 Z4	1987 477 237	4806 C8	1987 481 018	4806 76	1987 481 019
4745 K3	1987 477 585	4745 Z7	1987 482 000	4806 C9	1987 481 019	4806 77	1987 481 002
4745 K4	1987 477 443	4745 Z8	1987 482 001	4806 E0	1987 476 785	4806 78	1987 476 678
4745 K5	1987 482 103	4745 40	1987 477 416	4806 E1	1987 476 780	4806 79	1987 476 809
4745 K6	1987 482 113	4745 52	1987 477 417	4806 E2	1987 476 355	4806 80	1987 476 810
4745 K7	1987 482 114	4745 54	1987 477 419	4806 E3	1987 476 178	4806 81	1987 476 679
4745 K8	1987 477 445	4745 57	1987 477 420	4806 E7	1987 476 372	4806 82	1987 476 951
4745 K9	1987 477 446	4745 58	1987 477 421	4806 E8	1987 476 374	4806 83	1987 476 844
4745 L6	1987 477 573	4745 63	1987 477 144	4806 E9	1987 476 651	4806 84	1987 476 785
4745 N3	1987 482 115	4745 64	1987 477 145	4806 F6	1987 476 457	4806 85	1987 476 651
4745 N8	1987 477 434	4745 65	1987 477 146	4806 G4	1987 481 051	4806 86	1987 476 178
4745 N9	1987 477 435	4745 66	1987 477 151	4806 G5	1987 481 052	4806 91	1987 476 785
4745 P0	1987 477 774	4745 67	1987 477 273	4806 20	1987 476 150	4806 92	1987 476 746
4745 P1	1987 477 870	4745 68	1987 477 272	4806 22	1987 476 863	4806 93	1987 476 915
4745 P2	1987 477 870	4745 69	1987 477 270	4806 23	1987 476 666	4806 94	1987 476 914
4745 P5	1987 477 590	4745 70	1987 477 271	4806 24	1987 476 548	4806 96	1987 476 329
4745 P6	1987 477 591	4745 71	1987 477 422	4806 26	1987 476 667	4806 97	1987 476 870
4745 P8	1987 477 593	4745 73	1987 477 148	4806 29	1987 476 519	4806 98	1987 476 869
4745 P9	1987 477 594	4745 74	1987 477 147	4806 30	1987 476 668	4816 14	1987 476 680
4745 R0	1987 477 595	4745 75	1987 477 149	4806 31	1987 476 521	4816 16	1987 476 681
4745 R5	1987 477 712	4745 76	1987 477 150	4806 32	1987 476 522	4816 21	1987 476 682
4745 R7	1987 477 871	4745 89	1987 477 427	4806 34	1987 476 668	4816 22	1987 476 683
4745 R8	1987 477 871	4745 97	1987 477 429	4806 35	1987 476 463	4816 23	1987 476 684
4745 T3	1987 477 598	4745 98	1987 477 430	4806 36	1987 476 462	4816 24	1987 476 954
4745 T4	1987 477 442	4745 99	1987 477 431	4806 37	1987 476 520	4816 25	1987 476 685
4745 T5	1987 477 565	4746 V6	1987 482 002	4806 39	1987 476 531	4816 26	1987 476 686
4745 T6	1987 477 713	4746 10	1987 482 118	4806 40	1987 476 670	4816 27	1987 476 244
4745 T7	1987 477 714	4746 11	1987 482 007	4806 41	1987 476 532	4816 29	1987 476 523
4745 T8	1987 477 714	4746 12	1987 482 008	4806 42	1987 476 534	4816 31	1987 476 688
4745 T9	1987 477 775	4746 13	1987 477 993	4806 44	1987 476 673	4816 35	1987 476 688
4745 V0	1987 477 599	4746 14	1987 482 112	4806 45	1987 476 669	4816 36	1987 476 689
4745 V1	1987 477 600	4746 15	1987 477 238	4806 46	1987 476 534	4834 71	1987 477 449
4745 V2	1987 477 262	4746 16	1987 477 239	4806 47	1987 476 670	4834 72	1987 477 450
4745 V3	1987 482 006	4746 17	1987 482 213	4806 48	1987 476 532	4834 75	1987 477 451
4745 V5	1987 477 263	4746 18	1987 482 214	4806 50	1987 476 521	4834 80	1987 477 452
4745 V7	1987 482 004	4746 19	1987 477 954	4806 52	1987 476 671	4834 81	1987 477 453
4745 W3	1987 477 822	4746 20	1987 477 598	4806 53	1987 476 523	4834 85	1987 477 455
4745 W4	1987 477 823	4746 30	1987 477 775	4806 54	1987 476 520	4861 A2	0 204 031 184
4745 W5	1987 482 003	4746 31	1987 482 190	4806 55	1987 476 672	4861 A4	0 204 031 202
4745 X1	1987 477 115	4746 34	1987 482 000	4806 56	1987 476 558	4861 A5	0 204 031 182
4745 X2	1987 482 116	4746 35	1987 482 001	4806 58	1987 476 673	4861 A6	0 204 031 183
4745 X4	1987 477 994	4746 42	1987 482 206	4806 61	1987 476 674	4861 A7	0 204 031 185
4745 X5	1987 477 592	4746 43	1987 482 205	4806 62	1987 476 675	4861 C2	0 204 031 277
4745 X8	1987 477 576	4746 44	1987 482 208	4806 63	1987 476 559	4861 02	0 204 131 001
4745 X9	1987 477 595	4746 45	1987 482 207	4806 64	1987 476 676	4861 08	0 204 131 010
4745 Y0	1987 482 116	4806 A0	1987 476 912	4806 65	1987 476 560	4861 18	0 204 131 038
4745 Y1	1987 482 117	4806 A1	1987 476 913	4806 67	1987 476 947	4861 20	0 204 131 024
4745 Y2	1987 477 951	4806 A6	1987 476 072	4806 68	1987 476 679	4861 21	0 204 131 019
4745 Y3	1987 477 952	4806 A8	1987 476 785	4806 69	1987 476 677	4861 26	0 204 131 024
4745 Y6	1987 477 953	4806 A9	1987 476 868	4806 70	1987 481 063	4861 27	0 204 131 035
4745 Y7	1987 477 953	4806 C0	1987 476 867	4806 71	1987 476 329	4861 32	0 204 131 226
4745 Y8	1987 477 954	4806 C1	1987 476 078	4806 72	1987 481 017	4861 33	0 204 131 037
4745 Y9	1987 477 993	4806 C3	1987 481 004	4806 73	1987 481 061	4861 38	0 204 131 226
4745 Z0	1987 477 823	4806 C4	1987 476 629	4806 74	1987 476 519	4861 42	0 204 131 045

◀ CITROEN

4861 43	0 204 131 044	5 488 527	F 026 002 083	91 510 533	0 204 122 243	95 496 106	1 987 477 077
4861 44	0 986 482 009	5 488 527	0 204 116 083	91 510 872	F 026 003 064	95 496 631	F 026 003 076
4861 45	0 204 131 049	5 488 527 C	F 026 002 083	91 510 872	0 204 123 064	95 496 631	0 204 123 076
4861 46	0 986 482 005	5 488 527 C	0 204 116 083	91 51 487 880	0 261 231 001	95 496 738	F 026 002 122
4861 47	0 986 482 005	5 488 528	0 204 116 084	91 514 880	0 261 231 006	95 496 738	0 204 116 122
4861 49	0 204 131 048	5 490 764 T	0 204 123 049	91 515 816	1 987 476 519	95 534 127	0 204 116 514
4861 50	0 204 131 046	55 947 714	0 204 163 105	91 517 513	1 987 476 521	95 542 783	0 986 475 233
4861 52	0 204 131 053	5887 6A	F 026 002 087	91 521 171	F 026 003 054	95 542 784	0 986 475 234
4861 53	0 204 131 052	5887 6A	0 204 116 087	91 521 171	0 204 123 054	95 542 785	0 986 475 231
4861 54	0 204 131 064	5 925 334	1 987 477 419	93 327 326	0 265 006 389	95 548 953	1 987 477 479
4861 55	0 204 131 065	5946 03	0 261 231 006	94 04 402 708	0 986 475 420	95 555 655	0 204 123 049
4861 60	0 204 131 067	5946 05	0 261 231 007	94 04 402 868	0 986 475 619	95 562 403	0 204 124 039
4861 61	0 204 131 069	5946 15	0 261 231 071	94 04 402 878	0 986 475 620	95 568 486	0 986 475 590
4861 63	0 204 131 082	5946 17	0 261 231 071	9404 541 AF8	0 265 235 011	95 568 492	0 204 116 035
4861 64	0 204 131 084	5946 18	0 261 231 070	94 045 41A98	0 265 225 189	95 569 738	F 026 002 094
4861 65	0 204 131 232	5946 21	0 261 231 045	9404 541 C48	0 265 231 477	95 569 738	0 204 116 094
4861 66	0 204 031 050	5946 22	0 261 231 109	94 045 41EH8	0 265 234 213	95 569 739	F 026 002 093
4861 66	0 204 131 217	5946 23	0 261 231 188	94 045 41EQ8	0 265 230 078	95 569 739	0 204 116 093
4861 67	0 204 131 086	5946 25	0 261 231 125	94 045 41ET8	0 265 231 975	95 571 755	0 204 123 047
4861 68	0 204 131 067	5946 28	0 261 231 128	94 045 41EW8	0 265 235 362	95 588 899	0 204 102 036
4861 69	0 204 131 085	5946 30	0 261 231 130	94 045 41FK8	0 265 231 797	95 588 900	0 204 102 037
4861 72	0 204 131 232	63 120 300	0 204 102 205	94 045 41FQ8	0 265 231 797	95 594 171	0 204 131 126
4861 73	0 204 131 092	63 227 500	0 204 123 022	94 045 41GQ8	0 265 231 975	95 594 172	0 204 131 039
4861 74	0 204 131 093	74 01 367 643	0 261 231 007	94 045 41GT8	0 265 235 362	95 594 173	0 204 131 259
4861 77	0 986 482 029	75 422 063	1 987 476 491	94 045 41GW8	0 265 232 349	95 595 193	F 026 003 076
4861 78	0 204 131 082	75 491 955	0 204 116 467	94 045 41GY8	0 265 230 492	95 595 193	0 204 123 076
4861 79	0 204 131 084	75 491 956	0 204 116 298	9404 541 G98	0 265 234 141	95 599 101	1 987 476 529
4861 80	0 204 131 256	75 492 063	1 987 476 491	94 045 41HX8	0 265 230 492	95 604 194	1 987 477 485
4861 84	0 204 131 270	75 494 063	1 987 476 491	94 045 41JP8	0 265 232 393	95 606 669	F 026 002 080
4861 85	0 204 131 271	75 510 162	1 987 477 075	9404 541 L98	0 265 234 053	95 606 669	0 204 116 080
4861 86	0 204 131 272	77 10 015 915	1 987 477 416	94 045 41N88	0 265 234 213	95 607 096	0 986 471 672
4861 89	0 204 131 257	79 01 440 247	0 986 475 233	9404 541 P78	0 265 234 038	95 607 097	0 986 472 672
4861 90	0 204 131 258	79 01 440 248	0 986 475 234	9404 541 R28	0 265 234 396	95 608 288	0 265 200 023
4861 91	0 204 131 268	79 01 440 249	0 986 475 231	94 045 41Y68	0 265 231 797	95 608 289	0 265 200 023
4861 92	0 204 131 269	79 01 444 837	0 204 104 063	94 04 541 568	0 265 216 758	95 608 852	F 026 002 128
4861 95	0 204 031 109	7908 33	F 026 002 565	94 04 541 628	0 265 216 863	95 608 852	0 204 116 128
4861 95	0 204 131 328	79 10 015 917	1 987 477 416	94 04 541 968	0 265 225 216	95 608 853	F 026 002 206
4861 96	0 204 031 110	79 10 017 919	0 204 123 056	94 04 601 858	F 026 003 243	95 608 853	0 204 116 206
4861 96	0 204 131 329	79 10 018 046	0 204 123 055	94 04 601 858	0 204 122 243	95 608 854	F 026 002 207
4861 99	0 204 031 181	79 10 018 158	1 987 476 684	94 04 601 978	F 026 003 103	95 608 854	0 204 116 207
4883 72	0 204 116 506	79 10 022 381	0 204 131 035	95 044 362	1 987 477 483	95 609 029	0 204 131 043
4915 0M	F 026 002 087	79 10 022 622	1 987 476 682	95 492 971	1 987 477 082	95 609 790	0 986 471 776
4915 0M	0 204 116 087	79 10 022 623	1 987 476 683	95 492 972	1 987 477 081	95 609 791	0 986 471 777
51 784 533	1 987 482 206	79 10 027 051	0 204 123 051	95 493 016	1 987 476 756	95 610 161	1 987 477 486
5 400 817	0 204 116 034	79 10 027 463	0 204 131 038	95 493 191	0 204 123 049	95 610 162	1 987 477 486
5 400 817 H	0 204 116 034	79 10 030 170	F 026 002 094	95 493 192	F 026 003 046	95 610 344	0 265 103 009
5 401 711	0 204 122 032	79 10 030 170	0 204 116 094	95 493 192	0 204 123 046	95 610 350	0 265 001 098
5 411 942	0 204 116 035	79 10 033 436	1 987 477 479	95 493 193	0 204 123 047	95 611 063	0 204 120 018
5 411 942 G	0 204 116 035	91 500 635	1 987 476 686	95 493 550	1 987 477 479	95 611 505	1 987 477 077
5 418 738	0 204 123 005	91 500 900	1 987 476 150	95 494 014	1 987 476 683	95 619 547	0 986 471 885
5 418 738 B	0 204 123 005	91 503 888	0 204 162 029	95 494 208	F 026 003 060	95 619 548	0 986 471 886
5 436 616	0 204 131 012	91 504 162	F 026 003 057	95 494 208	0 204 123 060	95 623 221	0 986 471 778
5 479 183	0 204 122 025	91 504 162	0 204 123 057	95 494 973	1 987 476 524	95 623 222	0 986 471 779
5 479 184	F 026 003 039	91 507 930	0 204 125 020	95 495 125	0 204 131 255	95 624 920	0 986 471 672
5 479 184	0 204 122 039	91 510 533	F 026 003 243	95 495 609	0 204 123 073	95 624 921	0 986 472 672

95 624 922	0 204 102 593	96 015 069	0 204 102 289	96 128 156	0 265 006 314	96 275 932	0 261 231 128
95 624 923	0 204 102 230	96 015 070	0 204 102 242	96 132 698	1 987 476 651	96 277 119	1 987 477 577
95 633 277	0 204 123 034	96 015 070	0 204 102 290	96 140 648	0 265 003 099	96 280 713	0 265 006 389
95 637 307	0 265 001 157	96 019 357	0 204 125 060	96 140 648	0 265 003 131	96 286 484	0 261 231 125
95 638 095	0 265 001 158	96 026 870	1 987 477 489	96 140 648	0 265 006 201	96 28 846 980	1 987 482 103
95 644 348	F 026 003 103	96 026 873	1 987 477 490	96 145 739	1 987 477 437	96 28 847 280	1 987 482 114
95 650 933	0 986 471 885	96 026 875	1 987 477 491	96 152 157	0 265 100 073	96 297 255	0 265 006 441
95 650 934	0 986 471 886	96 032 561	1 987 477 078	96 155 330	0 204 131 069	96 298 338	0 265 216 554
95 651 048	0 204 102 245	96 032 564	1 987 477 323	96 165 284	0 204 131 068	96 300 147	0 265 005 404
95 651 049	0 204 102 246	96 032 565	1 987 477 079	96 165 516	0 265 003 105	96 303 414	0 265 005 211
95 651 050	0 204 100 125	96 037 065	0 261 231 034	96 165 516	0 265 003 130	96 303 414	0 265 005 290
95 651 051	0 204 104 051	96 037 068	0 261 231 033	96 165 516	0 265 006 200	96 304 355	0 265 109 089
95 658 555	0 986 471 659	96 037 346	1 987 476 796	96 168 084	0 261 231 045	96 304 355	0 265 109 414
95 658 556	0 986 472 659	96 04 541 498	0 265 202 419	96 176 679	1 987 477 434	96 305 329	0 265 216 544
95 658 573	0 986 471 885	96 04 541 668	0 265 216 544	96 180 488	0 265 003 128	96 311 517	0 265 216 605
95 658 574	0 986 471 886	96 046 511	0 204 125 080	96 180 488	0 265 006 199	96 315 775	0 204 031 110
95 659 474	F 026 002 230	96 046 513	0 986 485 094	96 181 977	0 265 006 200	96 317 068	0 265 006 544
95 659 474	0 204 116 230	96 047 310	0 204 131 046	96 181 977	0 265 006 201	96 317 069	0 265 006 545
95 659 475	F 026 002 231	96 054 858	0 204 125 104	96 181 978	0 265 006 200	96 336 665	0 265 216 643
95 659 475	0 204 116 231	96 055 917	0 204 125 102	96 181 979	0 265 006 200	96 338 266	1 987 477 590
95 659 534	F 026 003 243	96 071 329	0 265 003 065	96 181 979	0 265 006 201	96 338 267	1 987 477 591
95 659 534	0 204 122 243	96 075 932	F 026 003 142	96 183 217	0 265 006 205	96 340 455	0 265 109 415
95 659 583	0 265 208 321	96 075 932	0 204 123 142	96 183 261	0 265 006 206	96 353 847	0 265 007 423
95 659 617	F 026 003 174	96 086 319	0 265 005 111	96 190 724	1 987 477 431	96 353 848	0 265 007 424
95 659 637	0 204 102 269	96 087 509	0 265 003 078	96 190 725	1 987 477 432	96 382 908	0 265 006 659
95 659 638	0 204 102 270	96 087 509	0 265 003 128	96 209 110	1 987 477 442	96 384 235	0 261 231 128
95 659 647	0 265 208 029	96 087 509	0 265 006 199	96 209 668	0 265 208 305	96 386 487	0 265 007 423
95 659 664	F 026 002 131	96 087 996	0 265 100 073	96 210 452	0 265 005 111	96 391 792	1 987 477 595
95 659 664	0 204 116 131	96 089 629	0 265 003 079	96 213 344	0 261 231 109	96 413 154	0 265 109 432
95 659 665	F 026 002 132	96 089 629	0 265 003 129	96 217 750	0 265 006 201	96 413 162	0 265 109 089
95 659 665	0 204 116 132	96 089 629	0 265 006 202	96 217 752	0 265 006 200	96 413 162	0 265 109 414
95 659 668	F 026 002 180	96 102 107	1 987 476 729	96 217 753	0 265 006 202	96 415 250	0 265 005 253
95 659 668	0 204 116 174	96 10 342 680	0 265 100 066	96 217 755	0 265 006 204	96 415 250	0 265 005 290
95 659 673	F 026 002 222	96 105 849	0 265 003 072	96 217 756	0 265 006 203	96 417 091	0 265 109 415
95 659 673	0 204 116 222	96 105 849	0 265 003 126	96 217 759	0 265 006 199	96 419 753	0 265 225 128
95 659 674	F 026 002 223	96 105 849	0 265 006 207	96 217 763	0 265 006 207	96 419 842	0 204 031 181
95 659 674	0 204 116 223	96 105 850	0 265 003 073	96 217 765	0 265 006 208	96 429 334	0 265 109 089
95 661 913	0 986 471 885	96 105 850	0 265 006 208	96 218 046	0 265 006 209	96 431 704	0 265 006 732
95 661 914	0 986 471 886	96 106 095	0 265 003 080	96 222 503	1 987 477 576	96 435 942	0 265 109 089
95 666 799	0 204 102 277	96 106 095	0 265 003 123	96 224 349	1 987 477 435	96 435 942	0 265 109 414
95 666 800	0 204 102 278	96 106 095	0 265 006 314	96 224 350	1 987 477 432	96 436 596	0 265 007 423
95 667 768	0 204 125 134	96 107 372	0 204 125 508	96 226 465	0 204 131 067	96 436 605	0 265 007 424
95 667 816	0 204 102 279	96 107 433	0 204 125 094	96 227 489	0 265 006 203	96 436 880	0 265 007 424
95 667 817	0 204 102 280	96 108 552	0 204 125 079	96 231 343	0 261 231 109	96 436 977	0 265 007 423
95 667 821	0 204 100 125	96 109 017	1 987 476 597	96 246 212	0 265 216 342	96 449 667	0 265 007 423
95 668 067	F 026 002 234	96 119 305	0 986 485 094	96 247 334	0 204 131 092	96 449 668	0 265 007 424
95 668 067	0 204 116 226	96 124 223	1 987 476 560	96 247 342	0 204 131 093	96 454 477	0 265 005 253
95 668 067	0 204 116 234	96 124 230	1 987 476 730	96 247 347	0 204 131 092	96 454 477	0 265 005 290
95 668 068	F 026 002 235	96 124 733	0 204 131 065	96 251 923	0 265 216 341	96 461 258	0 265 007 779
95 668 069	0 986 475 636	96 127 657	0 261 231 071	96 252 750	0 265 216 482	96 469 709	0 265 007 668
95 668 070	0 986 475 635	96 127 657	0 261 231 106	96 252 846	0 265 006 205	96 469 711	0 265 007 667
95 672 052	0 204 125 715	96 127 658	0 261 231 070	96 255 387	0 265 006 315	96 469 712	0 265 007 665
96 000 158	0 204 123 113	96 128 155	0 265 003 064	96 255 404	0 265 006 314	96 469 725	0 265 007 666
96 012 379	1 987 477 488	96 128 156	0 265 003 080	96 263 856	1 987 477 574	96 479 291	0 265 109 089
96 015 069	0 204 102 241	96 128 156	0 265 003 123	96 272 628	0 265 006 205	96 480 873	0 265 006 793

◀ CITROEN

96 494 001	0 265 005 714
96 497 761	0 265 005 606
96 499 043	0 265 005 292
96 499 043	0 265 005 715
96 502 357	0 265 005 290

96 502 361	0 265 005 486
96 504 521	0 265 005 290
96 507 862	0 265 109 089
96 515 901	0 265 218 630
96 519 693	0 265 007 707

96 526 967	0 265 007 664
96 526 969	0 265 007 780
96 536 631	0 265 007 789
96 552 700	0 265 007 788
96 571 232	0 265 005 629

96 571 232	0 265 005 724
96 584 207	0 265 007 779
96 585 998	0 265 007 883
96 80 318 480	1 987 482 112
97 501 150	0 204 163 022

97 501 690	0 204 163 010
97 902 141	0 204 123 059

DACIA

60 01 547 168	1 987 477 955
60 01 547 169	1 987 477 956
60 01 547 632	0 986 475 837

60 01 547 819	1 987 481 032
60 01 547 861	0 265 231 489
60 01 547 861	0 265 231 852
60 01 548 610	0 265 231 852
60 01 549 506	0 265 231 994

60 01 549 506	0 265 232 111
60 01 549 506	0 265 232 199
60 01 550 546	0 265 232 111
60 01 550 546	0 265 232 199
60 01 550 913	0 265 232 199

82 00 195 825	0 265 007 596
82 00 195 825	0 265 007 742
82 00 254 687	0 265 007 583
82 00 254 688	0 265 007 582

DAIHATSU

04008101B2	F 01G 062 OCD
04008102B2	F 01G 062 OCE
04008-104B2-A	0 204 053 396

04008-105B2-A	0 204 053 397
04008-106B2-A	0 204 053 398
04008-108B2-A	0 204 053 400
44610-B1200	0 204 053 155
44610-B1210	0 204 053 156

44610B2120	F 01G 061 0GV
44610B5010	F 01G 061 07Y
44610B5020	F 01G 061 07Z
44610B5030	F 01G 061 080
44610B5040	F 01G 061 081

4461087315	F 01G 09B 0LU
4461087719	F 01G 09B 0YN
4461087730	F 01G 09B 0YM
4461087731A	F 01G 09B 0YP
4461087732	F 01G 09B 0YR

4461097502	F 01G 09B 1TK
4461097505	F 01G 09B 1RV
4461097508	F 01G 09B 1TP
4461097508	F 01G 09B 1TR
4461097509	F 01G 09B 1TN

46042 80135 000	1 987 476 024
47201-B1140	0 204 053 154
47201B2090	F 01G 062 051
47201 B2120	F 01G 062 06P
47201B2121	F 01G 062 07D

47201B2141	F 01G 062 07E
47201B2241	F 01G 062 07F
47201B2280	F 01G 062 08W
47201B5010	F 01G 062 03K
47201B5020	F 01G 062 03J

4720187723	F 01G 09C 1AW
4720187726	F 01G 09C 1AV
4720187727	F 01G 09C 1AX
4720187728	F 01G 09C 1E8
4720197501	F 01G 09C 1DF

4720197504	F 01G 09C 1E9
4720197505	F 01G 09C 1EA
47203B5040	F 01G 262 06E
47221B2190	F 01G 262 066
47550-B1010	0 986 475 882

47550 87222 000	0 986 475 686
47550 87230 000	0 986 475 686
47550 87705 000	0 986 475 688
47550 87707 000	0 986 475 700
47550 87709 000	0 986 475 688

47550 87710 000	0 986 475 700
47570-B1010	0 986 475 881
47570 87704 000	0 986 475 687
47570 87706 000	0 986 475 699
47570 87709 000	0 986 475 687

47570 87710 000	0 986 475 699
90049 22090 000	1 987 481 043
90049 22119 000	1 987 476 873
90049 22156 000	1 987 481 133
90049 22168 000	1 987 481 134

90049 22174 000	1 987 476 872
90049 22175 000	1 987 476 871
96940 32605 000	1 987 476 495
96940 32805 000	1 987 476 495

EBRO (MISA)

06105087 0	0 204 102 299
06105093 1	0 204 102 295
06105094 1	0 204 102 296

06105111 1	0 204 102 621
06105113 1	0 204 102 304
06105114 1	0 204 102 305
06601267 1	0 204 131 131
06601611 0	0 204 131 144

06605571 0	0 204 131 142
06900852 0	0 204 123 230
06902278 0	0 204 116 324
06902317 0	0 204 116 569
06902372 0	0 204 116 315

06902564 0	0 204 123 241
06905222 1B	0 204 123 231

FIAT

1014105	1 987 476 239
11658 45545 01	1 987 476 000
1300250080	0 204 131 232

1306893080	1 987 481 061
1307963080	1 987 477 113
1308638080	1 987 477 114
1310462080	1 987 482 046
1311401080	1 987 476 329

1311457080	1 987 481 063
1314983080	1 987 477 115
1315251080	0 204 131 232
1320327080	0 265 006 427
1320328080	0 265 006 406

1320329080	0 265 006 405
1325030080	1 987 476 329
1329844080	1 987 477 263
1330058080	1 987 477 262
1330066080	1 987 482 006

1336889080	1 987 482 002
1337440080	1 987 477 263
1337455080	1 987 482 004
1339394080	1 987 482 003
1339676080	1 987 482 003

1341031080	1 987 482 213
1400203680	1 987 482 007
1400204880	1 987 482 008
1400310180	1 987 477 945
1400310180	1 987 477 953

1400310280	1 987 477 953
1400310380	1 987 477 954
1426562	F 026 005 587
1426562	0 204 163 087
1472155080	1 987 476 679

1472157080	1 987 476 947
1472957080	1 987 477 565
1472958080	1 987 477 524
1472959080	1 987 477 525
1473321080	1 987 477 569

14733220	1 987 477 568
1473322080	1 987 477 568
14 734 04080	0 204 131 082
1475675080	0 204 131 084
1479009080	0 204 131 084

1479010080	0 204 131 085
1479197080	1 987 476 951
1480845080	0 265 006 426
1480846080	0 265 006 388
1482480080	0 265 006 504

1483708080	1 987 477 597
1484385080	1 987 477 774
1484536080	1 987 476 072
1486594080	1 987 476 951
1487274080	1 987 477 713

1487275080	1 987 477 714
1487276080	1 987 477 565
1487647080	1 987 477 714
1489794080	1 987 476 951
1490515	1 987 482 189

1493882080	0 265 007 083
1493883080	0 265 007 084
171872	0 204 021 464
181587	0 265 220 595
2434701	0 332 512 009

4060871	1 987 482 194
4060872	1 987 482 195
4121616	0 986 475 273
4156091	0 204 122 245
4167824	1 987 476 237

4167824	1 987 481 012
4167825	1 987 476 237
4167826	1 987 476 238
4213025	1 987 476 239
4233045	1 987 477 083

4253987	1 987 476 239
4256246	1 987 476 245
4257052	1 987 476 245
4261125	1 987 477 083
4261126	1 987 477 083

4296605	1 987 476 003
4296606	1 987 476 003
4341780	0 204 122 245
4345508	1 987 477 359
4348052	1 987 476 239

4349187	1 987 476 003
4359202	1 987 477 417
4373614	0 986 475 273
4373680	0 204 122 245
4373736	F 026 002 529

4373736	0 204 116 529	46434529	0 265 006 164	46519886	0 265 007 039	46557523	0 265 005 225
4387206	1 987 477 297	4643453	0 265 006 163	46519916	0 265 007 036	46557523	0 265 005 241
4394460	0 986 475 273	46436578	0 204 131 265	46519917	0 265 007 037	46557523	0 265 005 277
4394469	F 026 002 529	46436579	0 204 131 266	46520005	0 265 007 038	46557534	0 265 007 086
4394469	0 204 116 529	46437961	1 987 477 724	46520022	0 265 216 534	46557535	0 265 007 085
4397019	0 204 122 256	46445139	0 265 216 406	46520026	0 265 216 568	46557536	0 265 007 089
4404484	F 026 002 470	46445139	0 265 216 418	46525288	0 261 231 144	46557537	0 265 007 089
4404484	0 204 116 470	46448474	1 987 476 860	46526190	F 009 D00 769	46731055	1 987 482 109
4406021	1 987 477 086	46448591	1 987 476 639	46530202	0 265 007 043	46737015	1 987 477 826
4415526	0 204 125 288	46448593	1 987 476 638	46530204	0 265 007 045	46737767	0 265 007 063
4415534	0 204 122 144	46450545	0 265 006 325	46531417	0 265 007 071	46737768	0 265 007 064
44223983	0 204 125 295	46454003	1 987 476 788	46531418	0 265 007 072	46737769	0 265 007 065
4423942	0 204 122 256	46454474	1 987 476 347	46531419	0 265 007 070	46737770	0 265 007 066
4425680	0 204 131 262	46456661	0 265 006 163	46531420	0 265 007 069	46738559	1 987 481 124
4426826	1 987 476 240	46456849	1 987 477 382	46531635	0 204 163 077	46738613	1 987 476 879
4450938	1 987 477 515	46456850	1 987 477 375	46531636	F 026 005 580	46744771	0 265 216 623
4464149	1 987 476 239	46457537	0 265 006 164	46535126	0 204 125 747	46745155	1 987 477 560
4471492	1 987 476 239	46460478	1 987 482 179	46539830	0 265 007 034	46745157	1 987 477 560
4477793	1 987 476 244	46460508	1 987 477 824	46539831	0 265 007 035	46749271	1 987 476 125
453575	0 204 125 328	46460544	0 265 006 364	46539832	0 265 007 032	46749276	0 986 486 091
4567861	1 987 476 462	46460545	0 265 006 365	46539833	0 265 007 033	46752063	0 265 007 071
4567862	1 987 476 463	46460699	1 987 481 189	46540022	0 265 007 050	46752064	0 265 007 072
46401725	1 987 477 382	46463910	1 987 482 180	46540023	0 265 007 049	46752399	0 986 486 107
46401730	1 987 477 382	46463911	1 987 477 825	46540024	0 265 007 055	46752977	1 987 477 561
46401855	0 265 005 030	46464658	1 987 477 551	46540025	0 265 007 054	46753680	0 265 005 418
46401856	0 265 005 030	46465194	1 987 477 826	46540826	0 986 486 073	46757058	1 987 477 562
46401856	0 265 005 031	46465947	1 987 477 552	46541666	0 986 486 563	46760308	1 987 476 824
46404401	0 265 006 210	46465948	1 987 477 824	46541667	0 986 486 556	46761337	0 265 007 098
46404402	0 265 006 211	46465949	1 987 482 179	46542381	0 265 220 553	46761338	0 265 007 099
46408830	1 987 477 390	46467348	0 265 006 124	46542604	1 987 477 550	46763852	0 265 007 073
46409003	0 204 125 474	46468156	1 987 477 552	46542755	1 987 477 554	46763853	0 265 007 074
46412282	0 204 125 476	46468157	1 987 477 827	46542828	1 987 477 831	46766308	1 987 477 723
46414286	1 987 482 179	46468158	1 987 477 828	46543441	0 986 486 077	46766309	1 987 477 723
46414289	1 987 482 179	46469784	0 265 006 249	46544765	0 265 007 075	46772456	0 265 007 101
4642111 18	0 265 006 212	46469867	0 261 231 131	46544766	0 265 007 076	46772459	0 265 007 100
46421112	0 265 006 238	46469867	0 261 231 148	46545467	0 265 007 051	46772460	0 265 007 101
46421118	0 265 003 074	46471701	1 987 477 829	46545468	0 265 007 053	46776188	0 265 006 673
46421118	0 265 006 212	46471702	1 987 477 830	46545469	0 265 007 052	46783183	0 265 007 102
46421122	0 265 006 138	46473033	0 265 006 539	46546713	1 987 477 555	467 8318 40	0 265 007 103
46421937	0 204 163 077	46473033	0 265 006 540	46546714	1 987 477 556	46784454	0 204 031 218
46421938	0 204 163 078	46473049	0 265 006 539	46546935	0 265 007 044	46784455	1 987 476 878
46421939	0 204 163 079	46473049	0 265 006 540	46547168	0 986 486 084	46784470	0 265 007 400
46421940	F 026 005 580	46474539	1 987 476 346	46547227	0 265 216 713	46784471	0 265 007 401
46421941	F 026 005 587	46478560	F 026 005 095	46547231	0 265 007 024	46786431	1 987 481 004
46421941	0 204 163 087	46478563	F 026 005 119	46547232	0 265 007 025	46786435	1 987 476 629
46421942	F 026 005 581	46478563	0 204 162 119	46547233	0 265 007 026	46799091	1 987 477 724
46422412	0 265 006 197	46478973	1 987 476 092	46547234	0 265 007 027	46799093	1 987 477 724
46423176	1 987 476 634	46481634	1 987 476 747	46547547	1 987 477 557	46803379	0 265 005 241
46423177	1 987 476 635	46481635	1 987 476 769	46552951	0 261 231 148	46803893	1 987 476 151
46423178	1 987 476 636	46481855	0 204 125 601	46552978	1 987 477 722	46805893	0 204 031 180
46423179	1 987 476 637	46481856	0 204 125 602	46554126	1 987 476 878	46807591	0 204 031 179
464 2353 80	0 204 131 274	46511039	1 987 477 562	46556013	1 987 476 092	46809773	0 265 006 689
46424868	F 026 005 119	46513013	0 265 216 402	46556045	1 987 476 972	46809774	0 265 006 688
46427958	0 265 006 262	46516374	0 986 486 104	46556688	1 987 477 558	46809897	1 987 481 185
46431514	1 987 477 550	46517955	1 987 477 553	46556689	1 987 477 559	46809898	1 987 476 877



◀ FIAT

46811818	0 265 224 062	46839673	0 265 008 007	51725099	0 265 007 685	51816421	0 204 031 336
46811818	0 265 224 084	46842227	0 265 007 542	51725100	0 265 007 686	51831575	0 204 031 318
46811818	0 265 224 096	46842228	0 265 007 543	51727705	0 265 007 129	51837313	0 204 024 593
46811818	0 265 224 098	46843704	0 204 031 184	51729492	1 987 481 158	51837340	0 204 031 179
46811818	0 265 224 102	46843705	0 204 031 202	51731443	1 987 477 928	51837341	0 204 031 180
46812916	0 204 024 593	46844825	0 265 007 564	51733637	0 204 051 043	51837342	0 204 031 199
46812922	0 204 031 184	46844826	0 265 007 565	51733638	0 204 051 040	51837344	0 204 031 182
46813948	1 987 477 912	46844827	0 265 007 566	51733731	1 987 481 048	51837345	0 204 031 183
46814034	1 987 476 876	46844828	0 265 007 567	51737851	0 265 007 831	51837346	0 204 031 184
46814147	1 987 482 182	46845902	1 987 477 972	51737851	0 265 007 832	51837347	0 204 031 185
46814148	1 987 482 181	46846931	0 265 007 510	51737852	0 265 007 832	51837348	0 204 031 185
46816928	0 265 007 401	46846932	0 265 007 511	51739596	0 204 032 900	51837348	0 204 031 202
46816929	0 265 007 400	46846933	0 265 007 512	51742256	0 265 007 678	543793	1 987 476 660
46819335	1 987 477 910	46846934	0 265 007 513	51745709	1 987 481 172	545379	1 987 476 660
46819336	1 987 477 911	46847297	1 987 477 831	51745715	0 265 007 639	54911400	1 987 476 858
46819820	0 986 486 105	46847416	1 987 477 969	51748608	0 265 007 691	55186669	0 261 231 176
46823093	0 265 007 486	46847417	1 987 477 968	51748935	1 987 481 067	55187210	0 986 486 073
46823093	0 265 007 487	46847434	1 987 477 925	51748936	1 987 481 004	55187214	0 986 486 105
46823094	0 265 007 486	4720087	0 204 125 582	51753207	1 987 482 147	55187820	0 261 231 173
46823094	0 265 007 487	47752064	0 265 007 072	51753208	1 987 482 147	55189156	0 986 486 092
46823095	0 265 007 488	4792417	0 204 131 239	51753526	1 987 482 202	55189164	0 986 486 084
46825396	1 987 482 186	50003039	1 987 477 296	51753527	1 987 482 201	55196186	0 986 486 107
46825397	1 987 482 185	50008743	1 987 481 190	51759243	0 265 007 678	55196189	0 986 486 556
46826211	0 265 007 113	50010522	0 265 006 402	51759509	0 265 007 830	55196190	0 986 486 563
46826474	0 265 007 111	50011475	0 265 006 164	51759919	1 987 481 066	55196254	0 986 486 105
46826474	0 265 007 112	50011475	0 265 006 537	51761978	0 265 007 795	55700425	0 265 007 671
46826475	0 265 007 111	50011476	0 265 006 163	51761985	0 265 007 796	55700425	0 265 234 353
46826475	0 265 007 112	50011476	0 265 006 538	51764254	0 265 007 833	55700426	0 265 007 769
46828247	0 265 007 640	50093165	0 265 001 336	51767150	1 987 481 158	55700926	1 987 477 973
46828247	0 265 008 006	50500557	1 987 477 112	51768620	0 265 007 678	55700927	1 987 477 977
46829766	1 987 477 970	50500558	1 987 477 111	51776180	1 987 477 912	55700928	1 987 477 974
46829767	1 987 477 971	50505370	1 987 477 112	51782787	0 265 007 833	55700929	1 987 477 978
46831064	0 265 005 277	50505371	1 987 477 111	51784533	1 987 482 205	55700975	1 987 476 454
46831396	1 987 481 019	506812	0 265 005 411	51784534	1 987 482 207	55701047	1 987 476 451
46833121	1 987 481 018	5101313	0 265 201 054	51784535	1 987 482 206	55701387	0 265 007 768
46833122	1 987 481 002	51042034	0 204 125 745	51784536	1 987 482 208	55701387	0 265 007 896
46833604	0 204 031 182	51493180	0 265 006 325	51785644	1 987 482 203	55701942	1 987 477 976
46833606	0 204 031 183	51700558	1 987 481 176	51785645	1 987 482 204	55701946	1 987 477 975
46833607	0 204 031 185	51701191	0 204 031 199	51786839	1 987 482 199	55701951	0 265 005 607
46834651	1 987 476 152	51702279	0 265 007 503	51786840	1 987 482 200	55703974	0 265 007 896
46835327	1 987 477 560	51702279	0 265 008 049	51787753	0 265 007 686	5895308	0 265 216 032
46835328	1 987 477 723	51702642	1 987 477 910	51787753	0 265 007 980	5895518	0 265 204 004
46835408	0 986 486 573	51702646	0 265 007 636	51791153	0 265 008 005	5895519	0 265 204 003
46836161	0 204 031 120	51705195	0 265 007 561	51791154	0 265 008 006	5895520	0 265 204 006
46837685	0 265 007 518	51705196	0 265 007 560	51791156	0 265 007 544	5895521	0 265 204 008
46837686	0 265 007 610	51705197	0 265 007 563	51791156	0 265 008 007	5895522	0 265 204 010
46837687	0 265 007 519	51705198	0 265 007 562	51792165	0 265 008 002	5895523	0 265 204 014
46837688	0 265 007 520	51706546	0 265 007 126	51792166	0 265 008 003	5895524	0 265 204 016
46837690	0 265 007 521	51708685	1 987 477 926	51792770	0 204 031 318	5895525	0 265 208 034
46838209	0 265 007 126	51708686	1 987 477 927	51797945	0 265 008 049	5895526	0 265 210 002
46838609	0 265 007 543	51713211	0 265 007 449	51799347	0 265 008 055	5895525	0 265 208 034
46838609	0 265 007 551	51713211	0 265 008 005	51799348	0 265 008 056	5896073	0 265 216 418
46838609	0 265 007 563	51718056	0 265 007 448	51801310	0 265 007 833	5896073	0 265 216 425
46838610	0 265 007 550	51718093	1 987 477 911	51812551	0 265 008 188	5896074	0 265 216 418
46839673	0 265 007 544	51718921	1 987 476 079	51816420	0 204 031 335	5896075	0 265 216 408

5896076	0 265 216 404	60528460	0 204 125 387	60630814	1 987 477 624	60806213	1 987 476 633
5923974	1 987 477 085	60534263	0 261 231 006	60651567	1 987 476 880	60806216	1 987 476 416
5926217	1 987 476 007	60536905	1 987 476 278	60652012	0 265 007 016	60806223	0 204 131 221
5939142	1 987 477 098	60537068	0 204 131 200	60652013	0 265 007 017	60806223	0 204 131 230
5939145	1 987 477 291	60545849	0 265 001 250	60652016	0 265 007 018	60806252	0 265 003 074
5940103	0 204 131 274	6054585	0 265 001 251	60652776	0 265 007 021	60806252	0 265 006 212
5941315	1 987 476 630	60545972	0 265 100 051	60652777	0 265 007 022	60806254	0 265 006 197
5944002	1 987 476 006	60546646	1 987 476 864	60652874	0 265 007 020	60806310	1 987 477 375
5950690	1 987 476 688	60547341	0 204 163 036	60653742	F 009 D00 856	60807521	0 265 201 054
5951339	1 987 477 290	60548743	0 261 231 007	60654885	1 987 477 728	60807526	0 265 001 301
5951342	1 987 477 289	60553252	0 204 125 403	60656290	0 265 007 040	60807530	0 332 512 009
5952296	1 987 476 548	60556377	0 204 125 401	60656291	0 265 007 041	60808170	0 265 208 034
5952297	1 987 476 548	60557363	0 265 003 061	60656301	0 265 007 042	60808397	0 265 003 075
5954071	1 987 476 007	60557409	0 265 003 062	60659263	0 265 007 046	60809183	0 204 162 083
5965862	1 987 476 442	60558015	0 265 001 268	60659264	0 265 007 047	60809348	F 026 005 092
5966282	1 987 477 420	60559269	0 265 003 066	60659265	0 265 007 018	60809348	0 204 162 092
5967970	1 987 476 240	60559406	0 265 001 267	60659265	0 265 007 048	60809727	F 026 005 091
5968667	1 987 476 006	60559895	1 987 476 750	60661488	1 987 477 623	60809727	0 204 162 091
5969735	1 987 477 296	60561392	0 265 210 002	60661490	1 987 477 624	60809897	F 026 005 095
5970619	1 987 477 421	60565464	0 265 003 101	60662823	0 261 231 152	60809922	0 204 125 601
5972813	1 987 476 416	60565464	0 265 006 119	60662824	0 261 231 153	60809966	F 026 002 158
5975798	0 204 125 319	60565479	0 265 006 118	60664187	1 987 477 729	60809966	0 204 116 158
5985827	1 987 476 239	60567047	0 204 163 074	60714480	0 204 122 156	60810394	0 265 005 030
5985946	1 987 476 006	60568226	0 204 125 109	60714527	0 204 122 156	60810394	0 265 005 031
5986578	1 987 476 442	605 7135 80	0 204 125 431	60724310	0 204 122 156	60810774	0 265 003 096
5987896	F 026 002 454	60576483	0 265 005 109	60729339	0 204 122 156	60810774	0 265 006 162
5987896	F 026 002 565	60577321	0 265 003 096	60729341	0 204 122 156	60810791	0 261 231 095
5987896	0 204 116 454	60577321	0 265 006 162	60744157	0 204 131 098	60811362	1 987 477 832
5987896	0 204 116 565	60577826	1 987 477 375	60749844	0 204 122 169	60811576	0 265 204 004
5989142	1 987 476 630	60580075	1 987 477 620	60749849	0 204 122 171	60811577	0 265 208 034
5994021	0 204 122 175	60582751	0 265 105 036	60749881	0 204 104 049	60811672	0 265 208 034
60475505	0 204 102 237	60583353	F 026 005 094	60749888	0 204 116 113	6081172	0 265 204 004
60501237	F 026 005 080	60585551	0 204 125 439	60749889	0 204 116 114	60811771	F 026 005 581
60501672	1 987 477 518	60586737	F 026 005 091	60749984	0 204 116 124	60811973	1 987 477 390
60501673	1 987 477 620	60586737	0 204 162 091	60749985	0 204 116 125	60812073	0 204 125 431
60501727	1 987 476 858	60586738	F 026 005 092	60750112	0 204 122 182	60812250	1 987 476 639
60501737	0 204 131 205	60586738	0 204 162 092	60750204	F 026 002 137	60812266	0 204 163 079
60505496	0 204 163 060	60589820	0 204 125 405	60750204	0 204 116 137	60812359	0 204 163 077
60508245	0 265 100 034	60592752	0 261 231 095	60750205	F 026 002 138	60812394	0 265 006 212
60508246	0 332 512 009	60593842	0 204 162 096	60750205	0 204 116 138	60812395	0 265 006 162
6050825	0 265 001 074	60601097	0 265 006 118	60750452	0 204 122 164	60812644	0 265 006 197
60508251	0 265 001 073	60601098	0 265 006 119	60755049	0 204 102 238	60812743	0 265 216 425
60511530	0 204 162 078	60601099	0 265 006 120	60760115	0 986 471 007	60812799	1 987 477 375
60511713	1 987 476 864	60615270	0 265 006 162	60760115	0 986 471 027	60813055	1 987 477 375
60511751	0 265 001 156	60615953	0 265 006 260	60760116	0 986 471 006	60813056	1 987 477 382
60512698	0 261 231 006	60615954	0 265 006 261	60760116	0 986 472 027	60813773	0 265 006 238
60516271	0 986 486 504	60617232	0 204 122 215	60760117	0 204 122 156	60814217	0 204 163 077
60516390	0 204 131 097	60622632	0 265 006 325	60760117	0 204 122 192	60814827	F 026 005 095
60517201	0 204 122 156	60622633	0 265 006 326	60760126	0 204 122 201	60815246	F 026 005 580
60518185	0 204 163 061	60624590	1 987 477 621	60800249	0 204 122 156	60815759	F 026 005 119
60518194	0 204 162 076	60624591	1 987 477 622	60800372	1 987 476 629	60815759	0 204 162 119
60518212	0 204 131 204	60626919	1 987 477 725	60801464	0 265 201 016	60816027	0 265 007 073
60518251	0 204 131 199	60629717	1 987 477 726	60801543	0 204 131 202	60816028	0 265 007 074
60518265	0 204 131 201	60629718	1 987 477 657	60801577	F 026 005 580	66564165	0 265 208 027
60522547	1 987 476 000	60630812	1 987 477 623	60801790	1 987 477 389	7032156	0 204 122 156



◀ FIAT

7074619	0 986 480 656	71715088	0 265 222 029	71719731	0 265 222 041	71739576	0 265 234 353
7075450	0 204 032 347	71715088	0 265 222 041	71719733	0 265 225 194	71740005	F 026 003 430
7076333	0 204 032 313	71716386	0 265 216 782	71719733	0 265 225 281	71740406	0 265 231 741
7077141	0 204 032 359	71716574	0 265 216 802	71719822	0 265 224 094	71740408	0 265 235 058
7077392	0 204 032 926	71716576	0 265 216 810	71728281	0 265 220 680	71741511	0 265 231 807
70776333	0 204 032 601	71716578	0 265 220 603	71728281	0 265 220 695	71742838	0 986 475 951
7077697	0 204 032 301	71717166	0 265 216 828	71728283	0 265 231 366	71745440	0 265 235 230
7078950	0 204 032 599	71717285	0 265 224 049	71728285	0 265 231 368	71746361	0 265 235 232
7082042	0 204 032 385	71717287	0 265 225 090	71728285	0 265 231 709	71746405	0 265 225 196
7082150	0 986 475 901	71717287	0 265 225 092	71728319	0 265 216 828	71746405	0 265 225 392
7082215	0 986 480 866	71717287	0 265 225 233	71728349	0 265 225 227	71746428	0 265 231 927
71711253	0 265 216 402	71717828	0 265 216 709	71728349	0 265 225 269	71746430	0 265 234 545
71711651	0 265 216 453	71717849	0 265 225 083	71728349	0 265 225 399	71747604	0 265 231 929
71711893	0 265 216 504	71717849	0 265 225 094	71728869	0 265 005 428	71747606	0 265 235 292
71712386	0 265 216 677	71717849	0 265 225 345	71730143	0 265 225 233	71747707	0 265 225 380
71712387	0 265 216 436	71717851	0 265 225 094	71730275	0 265 005 303	71747778	0 265 235 358
71712388	0 265 216 500	71717851	0 265 225 345	71731640	0 265 220 692	71747792	0 265 225 398
71712389	0 265 216 526	71718131	0 265 220 630	71731642	0 265 222 035	71747794	0 265 225 399
71712390	0 265 216 530	71718131	0 265 220 695	71731644	0 265 225 264	71748843	0 265 233 364
71712391	0 265 216 532	71718177	0 265 216 707	71731646	0 265 231 438	7522590	1 987 477 296
71712392	0 265 216 534	71718338	0 265 224 062	71731646	0 265 231 807	7531828	1 987 476 445
71712393	0 265 216 687	71718338	0 265 224 084	71732672	0 265 220 695	7532204	1 987 476 445
71712394	0 265 216 550	71718338	0 265 224 096	71732680	0 265 225 269	7543163	0 204 125 336
71712395	0 265 216 552	71718338	0 265 224 098	71732680	0 265 225 399	7545170	0 204 125 345
71712397	0 265 216 572	71718338	0 265 224 102	71732682	0 265 225 281	7549015	1 987 476 413
71712397	0 265 216 601	71718555	0 265 231 313	71734809	0 265 225 196	7563845	1 987 476 416
71712398	0 265 216 526	71718557	0 265 234 013	71735339	0 265 222 043	7563849	1 987 476 442
71712398	0 265 216 570	71718558	0 265 225 044	71736094	0 265 222 041	7563850	1 987 476 442
71712398	0 265 216 711	71718558	0 265 225 380	71736096	0 265 224 096	7563851	1 987 476 445
71712399	0 265 216 572	71718671	0 265 220 657	71736096	0 265 224 098	7563852	1 987 476 006
71712400	0 265 216 568	71718840	0 265 225 090	71736096	0 265 224 102	7563854	1 987 476 007
71712401	0 265 216 615	71718840	0 265 225 092	71736524	0 265 231 536	7567862	1 987 476 463
71712403	0 265 216 621	71718840	0 265 225 233	71736526	0 265 234 199	7569160	1 987 476 459
71712405	0 265 220 415	71718841	0 265 225 092	71736868	0 265 225 345	7569161	1 987 476 413
71712406	0 265 220 454	71718841	0 265 225 233	71736874	0 265 224 098	7569593	1 987 476 689
71714663	0 265 216 743	71718842	0 265 225 143	71736874	0 265 224 102	7569594	1 987 481 018
71714723	0 265 216 619	71718842	0 265 225 361	71736988	0 265 231 618	7570315	1 987 476 244
71714724	0 265 216 623	71718842	0 265 225 398	71736990	0 265 233 330	7570316	1 987 476 688
71714725	0 265 216 711	71718843	0 265 234 007	71736992	0 265 234 069	7571999	0 204 131 221
71714726	0 265 216 713	71719014	0 265 006 197	71737629	0 265 231 633	7573600	1 987 476 428
71714727	0 265 220 553	71719431	0 265 216 709	71737631	0 265 233 336	7573601	1 987 476 460
71714732	0 265 220 547	71719580	0 265 224 084	71737633	0 265 234 259	7573814	1 987 477 331
71714733	0 265 225 004	71719580	0 265 224 096	71737635	0 265 224 102	7573858	1 987 476 954
71714735	0 265 225 032	71719580	0 265 224 098	71737761	F 009 D00 856	7577466	1 987 476 445
71714735	0 265 225 194	71719580	0 265 224 102	71737889	0 204 031 050	7577467	1 987 476 445
71714735	0 265 225 281	71719582	0 265 231 309	71737951	0 986 475 871	7583610	0 204 125 351
71714736	0 265 225 034	71719582	0 265 231 673	71738311	0 265 225 361	7586907	1 987 476 629
71714737	0 265 225 036	71719584	0 265 231 332	71738311	0 265 225 398	758750	1 410 506 131
71714738	0 265 224 029	71719585	0 265 234 021	71738467	0 204 163 077	7590581	1 987 476 630
71714738	0 265 224 062	71719587	0 265 234 040	71738478	0 265 231 582	7592743	0 204 125 348
71714738	0 265 224 084	71719587	0 265 234 326	71738480	0 265 233 338	7593353	1 987 476 416
71714738	0 265 224 096	71719725	0 265 216 944	71738480	0 265 233 364	7598922	0 204 125 359
71714738	0 265 224 098	71719727	0 265 216 946	71738535	0 265 231 673	7598927	1 987 476 460
71714738	0 265 224 102	71719729	0 265 216 960	71738953	0 265 234 326	75989280	0 204 125 360
71715088	0 265 222 012	71719731	0 265 222 029	71739565	0 265 231 709	7602061	0 204 125 362

7603316	1 987 476 428	7716537	0 265 204 003	77363307	0 204 125 834	77364123	0 204 123 720
7603330	1 987 476 006	7718934	0 265 001 337	77363347	F 009 D01 187	77364124	0 204 125 861
7607381	0 204 131 223	7718935	0 265 001 336	77363348	0 204 123 672	77364125	0 204 123 721
7609088	1 987 476 438	7726542	1 987 476 881	77363349	0 204 123 673	77364132	0 204 902 000
7609367	1 987 477 832	7729198	1 987 481 189	77363424	F 009 D01 188	77364133	0 204 902 001
7613939	0 265 201 024	7729634	0 986 475 867	77363425	0 204 123 676	77364194	0 204 123 708
7613939	0 265 208 034	7731008	0 204 162 093	77363519	0 204 004 437	77364196	0 204 123 709
76139399	0 265 201 024	7734997	F 026 002 157	77363520	0 204 004 438	77364197	0 204 123 684
7615326	1 987 477 088	77350080	1 987 476 634	77363612	0 986 480 858	77364198	0 204 125 851
7615327	1 987 477 087	7735009	1 987 476 635	77363619	0 986 480 993	77364199	0 204 123 710
7615338	1 987 477 089	7736207	0 204 123 621	77363664	0 204 125 855	77364205	0 204 123 722
7615339	1 987 482 149	77362074	0 204 123 623	77363664	0 204 125 866	77364206	0 204 123 723
7615342	1 987 477 375	77362099	0 204 123 625	77363780	0 204 125 847	77364207	0 204 123 724
7615343	1 987 477 376	77362106	0 204 125 792	77363781	0 204 125 849	77364208	0 204 123 725
7619751	1 987 476 633	77362107	0 204 123 592	77363849	0 986 475 936	77364303	0 204 902 018
7630317	0 265 001 215	77362108	0 204 125 791	77363859	0 204 125 850	77364305	0 204 902 019
7630318	0 265 001 216	77362152	0 204 125 806	77363860	0 204 123 682	77364396	0 204 902 031
7630319	0 265 001 217	77362164	0 204 024 917	77363863	0 204 125 918	77364397	0 204 902 030
7635376	1 987 476 631	77362383	0 204 125 808	77363864	0 204 123 685	77364398	0 204 902 033
7651142	F 026 003 430	77362384	F 026 003 628	77363866	0 204 123 683	77364398	0 204 902 120
7651142	0 204 123 430	77362384	0 204 123 628	77363867	0 204 125 852	77364399	0 204 902 032
7655155	1 987 476 438	77362404	F 026 003 636	77363870	0 204 125 853	77364399	0 204 902 119
7655156	1 987 476 438	77362404	0 204 123 636	77363871	0 204 123 688	77364466	0 204 125 868
7661241	1 987 477 091	77362405	F 026 003 635	77363872	0 204 123 686	77364467	0 204 123 734
7662724	1 987 481 017	77362405	0 204 123 635	77363873	0 204 123 687	77364471	0 204 125 900
7663039	1 987 476 632	77362445	0 986 475 925	77363897	0 204 125 852	77364472	0 204 123 764
7667806	1 987 476 633	77362463	0 986 475 937	77363924	0 204 004 562	77364491	0 986 480 988
7669123	0 261 231 007	77362468	0 204 125 814	77363924	0 204 902 030	77364610	0 204 125 906
7671309	1 987 477 377	77362469	F 026 003 641	77363925	0 204 004 563	77364611	0 204 123 766
7671310	1 987 482 108	77362469	0 204 123 641	77363925	0 204 902 031	77364646	0 204 001 965
7674977	1 987 476 749	77362513	0 204 125 816	77363929	0 204 004 564	77364648	0 204 001 966
7684513	1 987 477 381	77362514	F 026 003 648	77363929	0 204 902 032	77364727	0 204 125 905
7685929	0 204 131 720	77362514	0 204 123 648	77363929	0 204 002 119	77364731	0 204 902 070
7692964	F 026 003 430	77362517	0 204 125 817	77363930	0 204 004 565	77364733	0 204 902 071
7692964	0 204 123 430	77362518	0 204 123 650	77363930	0 204 902 033	77364743	0 204 125 916
7695929	0 204 131 720	77362526	0 204 123 649	77363930	0 204 902 120	77364782	0 204 125 917
7696710	F 026 002 454	77362543	0 204 125 807	77363933	0 204 004 566	77364793	0 204 125 916
7696710	F 026 002 565	77362610	0 204 116 604	77363934	0 204 004 567	77364809	0 204 123 765
7696710	0 204 116 454	77362617	0 204 116 601	77363937	0 204 004 568	77364841	0 204 902 089
7696710	0 204 116 565	77362621	0 204 116 602	77363937	0 204 902 004	77364842	0 204 902 090
7699530	0 204 131 378	77362727	0 204 131 714	77363938	0 204 004 569	77364856	0 204 123 783
7699530	0 204 131 720	77362729	0 204 131 715	77363938	0 204 902 005	77364857	0 204 125 918
7700356	0 204 031 050	77362744	0 204 004 338	77363964	0 204 125 855	77364911	0 204 902 099
7700356	0 204 131 217	77362746	0 204 104 279	77363964	0 204 125 866	77364924	0 204 102 871
7708289	0 204 162 088	77362748	0 204 004 339	77363965	0 204 123 712	77364925	0 204 102 872
7710140	0 265 201 054	77362803	0 204 102 523	77363967	0 204 123 711	77364950	0 204 123 784
7710976	0 204 125 420	77363165	F 009 D00 649	77363968	0 204 125 856	77365184	0 204 123 792
7711039	0 204 131 218	77363170	F 009 D00 655	77363969	0 204 123 714	77365227	0 204 125 946
7712078	0 265 001 338	77363171	F 009 D00 884	77363970	0 204 123 713	77365228	0 204 123 818
7713638	0 204 125 416	77363238	F 009 D01 097	77364028	0 986 475 940	77365229	0 204 125 947
7713643	0 204 125 418	77363239	0 204 123 669	77364117	0 204 125 859	77365230	0 204 123 816
7713643	0 204 125 550	77363241	F 009 D01 096	77364118	0 204 123 718	77365231	0 204 123 820
7713646	0 204 125 422	77363242	0 204 123 668	77364120	0 204 125 858	7739156	1 987 477 989
7714822	1 987 477 382	77363245	F 009 D01 098	77364121	0 204 123 719	7740758	F 026 002 178
7716265	0 204 125 429	77363306	0 204 125 833	77364122	0 204 125 860	7740758	0 204 116 178

◀ FIAT

77438990	0 204 131 241	790909	0 204 102 447	793266	0 204 122 243	82435663	0 265 001 247
7743900	0 204 131 240	790910	0 204 102 448	793290	0 204 122 245	82440062	1 987 476 862
7744077	0 204 125 450	791113	0 204 116 530	793307	0 204 122 256	82441688	1 987 477 389
7747331	1 987 477 383	791159	F 026 002 470	793309	0 204 122 297	82442723	0 265 001 209
7747332	1 987 477 384	791159	0 204 116 470	793332	0 204 122 258	82442878	1 987 476 876
7747333	1 987 477 730	791328	0 204 122 219	793437	0 986 475 654	82442897	0 204 162 081
7747334	1 987 477 730	791440	F 026 003 226	793438	F 026 002 457	82443349	0 204 125 389
7747954	0 204 125 449	791440	0 204 122 226	793438	0 204 116 457	82444381	0 986 471 007
7751335	0 204 131 234	791442	0 204 102 428	793439	F 026 002 458	82444381	0 986 471 027
7751336	0 204 131 233	791443	0 204 102 429	793439	0 204 116 458	82444381	0 986 472 838
7754462	0 204 125 602	791443	0 204 102 525	793722	F 026 003 226	82444382	0 986 471 006
7757560	1 987 477 651	791445	0 204 102 525	793722	0 204 122 226	82444382	0 986 472 027
7757585	0 204 125 443	791452	0 204 122 256	793764	0 204 102 605	824 4513 70	0 265 001 210
7757603	0 204 125 601	791456	0 204 131 223	793770	0 204 102 471	82445138	0 265 100 044
7757604	F 026 002 158	791458	0 204 131 267	793771	0 204 102 472	82448464	0 265 001 304
7757604	0 204 116 158	791459	0 204 131 337	793790	0 204 102 475	82450141	0 265 005 031
7759266	0 204 125 446	791462	0 204 131 226	793791	0 204 102 476	82451414	0 204 125 398
7759547	F 026 005 095	791475	0 204 131 227	793962	0 204 122 261	82451850	0 204 162 083
77598928	0 204 125 360	791811	0 204 131 226	794099	0 204 104 198	82455274	0 265 001 261
7762435	1 987 481 118	791897	0 204 102 484	794352	0 204 102 484	82455793	0 204 131 212
7764102	0 265 006 402	791898	0 204 102 485	794353	0 204 102 485	82458587	0 265 003 074
7765599	0 261 231 102	791899	0 204 102 440	81476616	0 204 125 434	82458587	0 265 006 212
7766248	0 265 006 140	791900	0 204 102 441	82303072	0 204 104 219	82458954	0 265 003 071
7766249	0 265 006 139	791952	0 204 100 392	82369266	0 204 122 147	82458954	0 265 006 262
7766594	0 265 208 034	792040	F 026 003 296	82383798	1 987 476 503	82458956	0 265 003 075
7773000	1 987 477 827	792040	0 204 122 296	82384952	1 987 476 503	8246063	0 265 001 072
7773001	1 987 477 828	792088	F 026 003 226	82388503	0 204 131 196	82461790	0 265 208 034
7773015	1 987 482 177	792088	0 204 122 226	82390661	1 987 476 641	82463795	0 204 125 415
7773019	1 987 482 178	792235	0 204 102 443	82390671	1 987 477 389	82466903	0 204 125 419
7773616	1 987 477 385	792235	0 204 102 528	82392239	1 987 476 640	82467204	0 265 003 075
77825160	0 265 001 387	792236	0 204 102 529	82397552	1 987 476 759	82468102	1 987 476 438
7788185	F 009 D00 768	792286	0 204 102 447	82401252	0 265 001 073	82472241	0 265 001 216
7791231	1 987 477 826	792287	0 204 102 448	82401253	0 265 201 016	82472242	0 265 001 217
7791233	1 987 477 552	792557	0 204 104 192	82401754	1 987 476 239	82472243	0 265 006 197
790137	0 204 123 233	792895	F 026 003 296	82404973	0 265 100 044	82473716	1 987 476 861
790204	0 204 122 256	792895	0 204 122 296	82406063	0 265 001 072	82473717	1 987 476 862
790205	0 986 480 654	792915	F 026 003 226	82407500	1 987 476 641	82474881	0 265 208 034
790215	0 986 475 273	792915	0 204 122 226	82407501	1 987 476 643	82475526	0 204 125 433
7903280	0 204 102 603	792987	0 204 122 256	82407503	0 204 131 202	82476616	0 204 125 434
790329	0 204 102 604	792999	F 026 003 226	82407679	0 265 001 074	82481842	1 987 477 390
790330	0 204 102 424	792999	0 204 122 226	82407928	1 987 476 642	82485111	0 265 003 121
790332	0 204 102 424	793007	0 204 122 225	82416097	1 987 477 388	82485111	0 265 006 238
790606	0 204 123 458	793010	F 026 003 226	82422138	1 987 476 640	82485174	0 265 006 160
790608	0 204 122 230	793010	0 204 122 226	82422141	1 987 476 641	82485175	0 265 006 300
790610	F 026 002 527	793034	0 204 122 230	82422142	1 987 476 642	82487709	1 987 477 655
790610	0 204 116 527	793039	0 204 122 230	82422143	1 987 476 641	82487780	1 987 477 656
790616	F 026 002 453	793047	0 204 123 458	82422144	1 987 476 643	82488245	1 987 477 726
790616	0 204 116 453	793053	0 204 122 230	82434698	0 265 100 042	82488246	1 987 477 657
790833	F 026 002 454	793060	0 204 102 460	82434699	0 265 105 035	82488247	1 987 477 658
790833	F 026 002 565	793061	0 204 102 461	82434700	0 265 005 030	87354681	F 009 D01 365
790833	0 204 116 454	793189	0 204 122 236	82434701	0 332 512 009	9050521	0 204 123 528
790833	0 204 116 565	793190	0 204 122 237	82435091	0 265 201 033	91373865	0 204 125 357
790837	0 204 122 230	793193	0 204 122 256	8243566	0 265 001 248	92323734	1 987 477 087
790838	0 204 122 230	793234	0 204 122 219	82435661	0 265 001 249	9404541368	0 265 216 496
790860	0 204 122 256	793266	F 026 003 243	82435662	0 265 001 246	9404541588	0 265 222 010

9404541598	0 265 225 166
9430835	F 009 D01 350
9460727	F 009 D01 351
9566949780	F 026 002 181
9566949780	0 204 116 181
9567205280	0 204 125 715
9567205380	F 026 003 166
9567205380	0 204 123 166
9567205480	0 204 123 182
9567211680	F 026 003 518
95674770	0 204 102 521
9567477080	0 204 205 235
95674771	0 204 102 523
9567477180	0 204 205 236
9621334480	0 261 231 109
962 86482 80	0 261 231 130
9639346180	1 987 477 823
9645447780	0 265 005 211
9645447780	0 265 005 290
9650452180	0 265 005 290
98845053	0 986 475 901
98845068	0 986 475 941
9936496	0 204 116 461
9937663	0 204 125 298
9937665	F 026 003 150
9937665	0 204 122 150
9938110	0 204 104 038
9938829	F 026 003 150
9938829	0 204 122 150
9938868	0 986 475 420
9939674	0 204 125 331
9939698	0 986 471 776
9939699	0 986 471 777
9939963	0 204 122 181
9940066	0 986 471 014
9940069	0 986 471 013
9940554	0 986 475 420
9940558	0 986 475 612
9940564	0 986 471 779
9940567	0 986 471 778
9940972	0 204 122 185
9941101	0 204 125 362
9941368	F 026 003 328
9941368	0 204 123 328
9941536	0 204 125 369
9941666	0 986 472 826
9941667	0 986 472 827
9942013	0 986 471 007
9942013	0 986 471 027
9942014	0 986 471 006
9942014	0 986 472 027
9942409	0 332 205 004
9942427	0 986 475 056
9942902	0 986 472 826
9942903	0 986 472 827

9942991	0 204 125 371
9943323	F 026 003 262
9943323	0 204 122 262
99434589	1 987 482 148
9943705	0 204 122 195
9943706	0 204 125 409
9944331	0 204 125 417
9944381	0 204 125 372
9944382	0 204 122 203
9944493	0 204 102 443
9944493	0 204 102 528
9944494	0 204 104 188
9944494	0 204 104 234
9944497	0 204 102 529
9945379	F 026 002 454
9945379	F 026 002 565
9945379	0 204 116 454
9945379	0 204 116 565
9945736	0 986 471 010
9945737	0 986 471 009
9945753	0 204 125 440
9945754	0 204 125 423
9945755	F 026 003 194
9945755	0 204 122 194
9945757	0 204 122 265
9945760	0 204 122 268
9945761	0 204 125 444
9945762	F 026 003 528
9945762	0 204 123 528
9945767	0 204 122 264
9945768	0 204 125 449
9945824	0 204 125 426
9945891	0 986 475 802
9945895	0 986 475 803
9945896	0 986 475 801
9945910	0 986 475 056
9945911	0 986 475 420
99459365	0 204 031 056
9945939	0 986 475 612
9945980	0 986 475 816
9946019	0 204 102 526
9946019	0 204 102 542
9946020	0 204 102 527
9946020	0 204 102 543
9946021	0 204 104 194
9946047	0 204 125 445
9946048	0 204 123 320
9946054	F 026 003 315
9946054	0 204 123 315
9946055	F 026 003 318
9946055	0 204 123 318
9946056	F 026 003 313
9946056	0 204 123 313
9946102	0 204 102 492
9946103	0 204 102 494

9946103	0 204 902 006
9946103	0 204 902 089
9946104	0 204 104 203
9946106	0 204 102 493
9946107	0 204 102 495
9946107	0 204 902 007
9946107	0 204 902 090
9946108	0 204 104 204
9946114	0 204 102 620
9946158	0 204 102 530
9946161	0 204 102 530
9946162	0 204 102 531
9946163	0 204 102 531
9946172	0 204 102 540
9946172	0 204 102 605
9946180	0 204 102 448
9946182	0 204 102 447
9946385	F 026 003 150
9946385	0 204 122 150
9946624	0 986 480 687
9946638	0 204 123 314
9946751	0 204 123 319
9946798	0 204 122 270
9946800	F 026 003 315
9946800	0 204 123 315
9946828	0 204 102 532
9946829	0 204 102 533
9946830	0 204 102 530
9946831	0 204 102 531
9946887	0 204 102 530
9946888	0 204 102 531
9946890	0 204 102 530
9946891	0 204 102 531
9946893	0 204 102 532
9946894	0 204 102 533
9946899	0 204 102 525
9947018	0 204 102 525
9947029	0 204 102 540
9947030	0 204 102 541
9947049	0 204 102 499
9947050	0 204 102 500
9947050	0 204 902 102
9947053	0 204 104 208
9947059	0 204 102 528
9947060	0 204 102 529
9947061	0 204 102 566
9947062	0 204 102 567
9947063	0 204 102 526
9947064	0 204 102 527
9947094	0 986 475 827
9947097	0 204 125 467
9947098	F 026 003 266
9947098	0 204 122 266
9947099	0 204 122 267
9947109	0 204 102 562

9947110	0 204 102 563
9947111	0 204 102 526
9947111	0 204 102 542
9947112	0 204 102 543
9947121	0 204 102 502
9947121	0 204 902 103
9947122	0 204 102 503
9947122	0 204 902 104
9947128	0 204 102 506
9947129	0 204 102 507
9947161	F 026 002 434
9947393	0 204 102 575
9947394	0 204 102 576
9947449	0 204 125 441
9947943	0 986 475 871
9948005	1 460 491 300
9948107	0 204 102 822
9948107	0 204 902 006
9948110	0 204 102 823
9948110	0 204 902 007
9948124	0 204 102 847
9948129	0 204 102 848
9948195	F 026 002 558
9948195	0 204 116 558
9948204	0 204 102 871
9948204	0 204 902 107
9948208	0 204 102 872
9948208	0 204 902 108
9948227	0 204 102 855
9948230	0 204 102 854
9948232	F 026 002 565
9948232	0 204 116 565
9948315	F 026 003 528
9948315	0 204 123 528
9948317	0 204 125 724
9948320	0 204 123 523
9948325	0 204 123 524
9948361	0 986 475 874
9948369	0 986 475 885
994 8382 00	0 204 021 854
99483920	0 204 125 520
994 8392 00	0 204 021 854
9948414	0 204 105 004
9948466	0 204 102 854
9948471	0 204 102 855
9948578	0 204 125 728
9948579	0 204 125 731
9948580	0 204 123 532
9948585	0 204 123 605
9948586	0 204 123 533
9948636	0 204 125 730
9948847	0 986 480 865
9948871	0 204 125 756
9948872	F 026 003 226
9948872	0 204 123 574



◀ FIAT

9948876	0 204 125 746
9948877	F 026 003 313
9948877	0 204 123 313
9948882	F 026 003 315
9948882	0 204 123 315
9948884	0 204 123 325
9948889	0 204 125 729
9948890	0 204 123 531
9948931	0 986 475 904
9949163	0 204 125 773
9949164	0 204 125 772
9949297	0 204 125 783
9949298	0 204 123 586
9949302	0 204 125 784
9949303	0 204 123 587
9949304	0 204 125 785
9949305	F 026 003 588
9949305	0 204 123 588
9949336	0 204 001 965
9949339	0 204 104 279
9949342	0 204 001 966
9949344	0 204 001 967
9949346	0 204 001 968
9949348	0 204 001 969
9949350	0 204 104 280
9949351	0 204 001 970
9949353	0 204 001 971
9949359	0 204 001 972
9949459	0 986 475 906
9949542	0 204 123 605
9949543	0 204 123 606
9949546	F 026 003 603
9949546	0 204 123 603
9949548	F 026 003 604
9949548	0 204 123 604
9949550	0 986 480 865
9949551	0 986 480 988
9949587	0 204 125 801
9949588	0 204 123 616
9949592	0 204 123 615
9949615	0 204 123 620
9949617	0 204 125 803
9949648	0 204 123 621
9949652	F 026 003 622
9949652	0 204 123 622
9949831	0 204 102 531
9950173	0 204 122 195
9950228	0 332 205 004
9950437	0 986 471 010
9950438	0 986 471 009
9950477	0 986 472 826
9950478	0 986 472 827
9950489	0 204 104 188
9950489	0 204 104 234
9950501	0 204 102 620

9950504	0 204 102 433
9950504	0 204 102 532
9950507	0 204 104 194
9950508	0 204 102 531
9950511	0 204 102 531
9950513	0 204 102 530
9950521	F 026 003 528
9950589	0 204 102 530
9950590	0 204 102 530
9950592	0 204 102 531
9950593	0 204 102 531
9950602	0 204 102 532
9950603	0 204 102 533
9950604	0 204 102 532
9950605	0 204 102 533
9950639	0 204 104 208
9950645	0 204 102 506
9950646	0 204 102 507
9950677	0 204 122 268
9950806	0 204 102 502
9950806	0 204 902 103
9950809	0 204 102 503
9950809	0 204 902 104
9950817	F 026 002 434
9950817	0 204 116 434
9951096	0 204 102 871
9951096	0 204 902 107
9951096	0 204 902 108
9951099	0 204 102 872
9951099	0 204 902 108
9951111	0 204 102 847
9951114	0 204 102 848
9951116	F 026 003 528
9951116	0 204 123 528
9951118	0 204 123 523
9951221	0 204 105 004
9980424	3 390 422 004
FORD	
BAF2 14B296 A	0 265 005 728
BA 12A699 A	0 261 231 045
BA 2C346 A	0 265 215 513
BA 2C353 A	0 265 219 535
BA 2C353 B	0 265 219 537
BA 2C353 C	0 265 219 535
BF2C 2004 A	0 204 032 326
BF5T 2140 A	0 204 032 294
BF6T 2140 AA	0 204 032 307
BG 2C381 A	0 265 007 973
C2S 12629	0 204 125 789
C2S 12630	0 204 125 790
C2S 13243	0 204 104 274

C2S 13244	0 204 104 261
C2S 13539	0 265 225 068
C2S 18008	0 204 104 274
C2S 18009	0 204 104 275
C2S 35775	0 265 225 068
C2S 38066	0 204 104 281
C2S 46538	0 204 205 119
C2S 48015	0 204 104 259
C2S 48023	0 204 104 261
DD91A B2282 BB	1 987 476 608
D77FB 2140 ALA	0 986 480 465
D8RZ 2261 B	F 026 002 105
D8RZ 2261 B	0 204 116 105
EL 2C204 A	0 265 006 230
ER 2C204 A	0 265 006 482
E5RD 2078 AA	1 987 476 381
E810 205S 208	1 987 477 236
E863 018S 100	1 987 477 020
F3XY 2C204 BA	0 265 006 560
F4ZZ 2C190 BB	0 265 006 431
F4ZZ 2C190 CB	0 265 006 432
F5RZ 2A63 5C	1 987 477 521
F5RZ 2261 A	0 986 475 750
F5RZ 2261 B	0 986 475 752
F5RZ 2552 A	0 204 102 272
F5RZ 2553 A	0 204 102 271
F5RZ 2553 A	0 204 102 859
F5RZ 7A543 A	0 986 486 055
F6DZ 2C190 B	0 265 006 150
F67Z 2140 HA	0 204 032 824
F7DZ 2C190 AA	0 265 006 149
F7DZ 2C190 CB	0 265 006 159
F7DZ 2C216 BB	0 265 006 158
F7ZZ 2C205 AB	0 265 006 286
F77F1 2A669 BB	0 261 231 119
F77F1 2A699 AB	0 261 231 114
F77F1 2A699 BA	0 261 231 114
F77F1 2A699 BA	0 261 231 119
F77F1 2A699 BC	0 261 231 119
F8DZ 2C204 AA	0 265 006 147
F9ZZ 2C286 EA	0 265 219 475
GD7E 4370 XD	0 265 006 316
RF9A 2140 A	0 204 032 615
R84FX 2N118 AC	0 986 47A 894
R84FX 2N118 AC	0 986 473 894
R84FX 2N119 AC	0 986 47A 893
R84FX 2N119 AC	0 986 473 893
R93BX 2552 BE	0 204 103 865
R93BX 2553 BE	0 204 103 864
R96FX 2B294 AA	0 986 47A 898
R96FX 2B294 AA	0 986 473 898
R96FX 2B294 BA	0 986 47A 910
R96FX 2B294 BA	0 986 473 910
R96FX 2B302 AA	0 986 47A 897
R96FX 2B302 AA	0 986 473 897

R96FX 2B302 BA	0 986 47A 909
R96FX 2B302 BA	0 986 473 909
SX 2C353 A	0 265 219 517
SY 2C405 A	0 265 234 318
VP1S7W 2B372 AD	0 265 007 879
YYC15 2L358 JB	0 204 131 695
V1C15 2B372 AA	0 265 007 125
V1C15 2B372 AB	0 265 007 125
V3C11 2L358 JA	0 204 131 709
V3C11 2L358 JB	0 204 131 709
V82FB 2005 AA	0 204 125 039
V84AB 2140 BA	0 986 480 609
V84FB 2140 BA	0 986 480 609
V84FB 2261 BA	0 204 116 355
V85BB 2A603 AC	1 987 477 229
V85BB 2A603 AE	1 987 477 229
V86AB 2140 AB	0 204 123 097
V92VB 2B120 CA	0 204 102 407
WR2A 2C204 AD	0 265 006 482
XF1Z 2C204 BB	0 265 006 148
XF3F1 2A699 AA	0 261 231 139
XF3Z1 2A699 AA	0 261 231 139
XF5Z 2C190 AB	0 265 006 454
XF5Z 2C204 AD	0 265 006 457
XF5Z 2C216 AB	0 265 006 455
XL3F1 2A699 AA	0 261 231 137
XL3F1 2A699 BA	0 261 231 138
XL3F1 2A699 CA	0 261 231 143
XM312 L304 AA	0 204 031 116
XN31 2282-AA	1 987 481 153
XR3Z 2C286 EA	6 002 A35 002
XS2Z 7A54 3AC	0 986 486 055
XS2Z 7A54 3AD	0 986 486 055
XS51 2078-CB	1 987 476 179
XS51 2078 CC	1 987 476 179
XS51 2261-AA	F 026 002 502
XS51 2261-AA	0 204 116 502
XS51 2261 BA	0 986 475 776
XS61 2078 CA	1 987 476 816
XS61 2078 DA	1 987 476 817
XS617 A543 AA	0 986 486 067
XS617 A543 AB	0 986 486 067
XS617 A543 AF	0 986 486 067
YC152 A635 AE	1 987 477 185
YC152 A635 AF	1 987 477 185
YC152 A635 BH	1 987 477 177
YC152 A635 BJ	1 987 477 177
YC152 A635 CH	1 987 482 036
YC152 A809 AG	1 987 477 180
YC152 A809 BJ	1 987 477 175
YC152 A809 BK	1 987 477 175
YC152 A809 CF	1 987 477 178
YC152 A809 CG	1 987 477 178
YC152 B107 AA	0 204 201 290
YC152 B120 AA	0 204 204 993

YC152 B121 AA	0 204 204 992
YC152 B352 BA	0 265 006 460
YC152 B372 AB	0 265 006 458
YC152 B372 AC	0 265 006 458
YC152 B372 AD	0 265 006 458
YC152 B372 AE	0 265 006 458
YC152 B372 AF	0 265 006 458
YC152 B372 BA	0 265 006 460
YC152 B372 BB	0 265 006 460
YC152 B372 BC	0 265 006 811
YC152 B372 CA	0 265 006 461
YC152 B372 CB	0 265 006 812
YC152 B372 DA	0 265 006 464
YC152 B372 DB	0 265 006 464
YC152 B372 DC	0 265 006 813
YC152 B372 EA	0 265 006 465
YC152 B372 EB	0 265 006 465
YC152 B372 EC	0 265 006 814
YC152 B372 FA	0 265 006 725
YC152 C285 CB	0 265 220 487
YC152 C285 DA	0 265 220 487
YC152 C285 DB	0 265 220 487
YC152 C285 DC	0 265 220 487
YC152 K478 AA	F 026 003 070
YC152 K478 AA	0 204 024 070
YC152 K478 AB	F 026 003 070
YC152 K478 AB	0 204 024 070
YC152 K478 BA	F 026 003 071
YC152 K478 BA	0 204 024 071
YC152 K478 BB	F 026 003 071
YC152 K478 BB	0 204 024 071
YC152 L358 AE	0 204 131 683
YC152 L358 AF	0 204 131 683
YC152 L358 BE	0 204 131 684
YC152 L358 CE	0 204 131 685
YC152 L358 CF	0 204 131 685
YC152 L358 DE	0 204 131 686
YC152 L358 DF	0 204 131 686
YC152 L358 ED	0 204 131 687
YC152 L358 EE	0 204 131 687
YC152 L358 FC	0 204 131 692
YC152 L358 FD	0 204 131 688
YC152 L358 FE	0 204 131 688
YC152 L358 GB	0 204 131 689
YC152 L358 GC	0 204 131 689
YC152 L358 HB	0 204 131 694
YC152 L358 KB	0 204 131 696
YC152 L526 AA	0 204 201 476
YC152 L527 AA	0 204 201 289
YC15 2078 EA	1 987 481 070
YC15 2078 FB	1 987 481 045
YC15 2261 AA	F 026 002 578
YC15 2261 AA	0 204 116 578
YC15 2282 DA	1 987 481 073
YC15 2282 EA	1 987 481 072

YC15 2853 AE	1 987 477 190
YC15 2853 BD	1 987 477 186
YC352 A032 AA	0 204 032 594
YC352 A032 CA	0 204 0A2 169
YC352 A032 DA	0 204 032 607
YDB 500400	0 265 003 100
YF1Z 2C190 AB	0 265 006 505
YF1Z 2C190 BB	0 265 006 506
YF1Z 2C346 AA	0 265 216 603
YM21 2078 AB	1 987 476 170
YM21 2078 AC	1 987 476 170
YS41 2261 AA	F 026 002 581
YS41 2261 AA	0 204 116 581
YS41 2261 BA	0 986 475 739
YS51 2261 AA	0 986 475 905
YS6T1 4B342 AA	0 204 125 459
YS61 2282 AD	1 987 476 447
1C15 2A635-AD	1 987 482 135
1C152 A635 CD	1 987 482 036
1C152 A635 CE	1 987 482 036
1C152 A809 AD	1 987 482 035
1C152 A809 AE	1 987 482 035
1C152 A809 AF	1 987 482 035
1C152 A809 CB	1 987 477 174
1C152 A809 CE	1 987 477 174
1C152 A809 CF	1 987 477 174
1C152 B372 AA	0 265 006 541
1C152 B372 AB	0 265 006 541
1C152 B372 AC	0 265 006 815
1C152 B372 BA	0 265 006 542
1C152 B372 BB	0 265 006 816
1C152 B372 CA	0 265 006 687
1C152 B372 CB	0 265 006 687
1C152 B372 CC	0 265 006 817
1C152 B372 CD	0 265 006 817
1C152 B372 DA	0 265 006 686
1C152 B372 DB	0 265 006 818
1C152 B372 DC	0 265 006 818
1C152 C285 BC	0 265 220 539
1C152 C285 BD	0 265 220 539
1C152 L358 BD	0 204 131 690
1C152 L358 BE	0 204 131 690
1C152 L358 CD	0 204 131 691
1C152 L358 CE	0 204 131 691
1C152 L358 FB	0 204 131 692
1C152 L358 FC	0 204 131 692
1C152 L358 GC	0 204 131 689
1C152 L358 HB	0 204 131 693
1C15 2005 AA	0 204 024 181
1C15 2005 AA	0 204 024 181
1E0 044150	1 987 477 517
1E00 44 150A	1 987 477 517
1F1Z2 C190 AB	0 265 006 649
1F1Z2 C190 BB	0 265 006 651
1F1Z2 C190 CB	0 265 006 648

1F1Z2 C190 DB	0 265 006 650
1F1Z2 C204 AB	0 265 006 646
1F1Z2 C204 BB	0 265 006 647
1L55 2005 AA	0 204 022 747
1M517 A543 AA	0 986 486 066
1M517 A543 AB	0 986 486 066
1S51 2853 AA	1 987 477 517
1S51 2853-AB	1 987 477 517
1S51 2853-AC	1 987 477 517
1S7T1 4B296 AB	0 265 005 236
1S7T1 4B296 AC	0 265 005 236
1S7T1 4B296 AC	0 265 005 414
1S7T1 4B296 AD	0 265 005 236
1S7T2 B372 AB	0 265 007 087
1S7T2 B372 AB	0 265 007 879
1S7T2 B372 AC	0 265 007 087
1S7T2 B372 AC	0 265 007 879
1S7T2 B372 AD	0 265 007 879
1S7T2 M118 AA	0 265 005 303
1S7T3 F818 AA	0 265 005 414
1S7T3 F818 AC	0 265 005 414
1S7T3 F818 AD	0 265 005 414
1S711 4B286 AC	0 265 005 236
1S712 A603 AA	1 987 477 734
1S712 A603 AE	1 987 477 990
1S712 A809 AD	1 987 477 734
1S712 A809 AG	1 987 477 734
1S712 A809 AH	1 987 477 734
1S712 A809 AJ	1 987 477 734
1S712 A809 AK	1 987 477 734
1S712 A809 BJ	1 987 477 733
1S712 A809 BK	1 987 477 733
1S712 A809 BL	1 987 477 733
1S712 A809 BM	1 987 477 733
1S712 B107 AB	0 204 104 259
1S712 B294 AB	0 204 001 958
1S712 B302 AB	0 204 001 957
1S712 B507 AB	0 204 123 578
1S712 B507 BB	0 204 123 579
1S712 C405 BB	0 265 225 170
1S712 C405 BC	0 265 225 170
1S712 C405 BD	0 265 225 170
1S712 C405 BE	0 265 225 170
1S712 C405 DA	0 265 225 170
1S712 L527 AA	0 204 104 261
1S712 L527 AB	0 204 104 261
1S712 M110 BA	0 265 222 031
1S712 M110 BB	0 265 222 016
1S712 M110 BB	0 265 222 031
1S712 M110 BC	0 265 222 016
1S712 M110 BC	0 265 222 031
1S71 2005 AA	0 204 125 766
1S71 2005 AB	0 204 125 766
1S71 2005 BB	0 204 125 768
1S71 2005 CB	0 204 125 767

1S71 2005 CC	0 204 125 767
1S71 2005 DB	0 204 125 769
1S71 2005 DC	0 204 125 769
1S71 2078 AE	1 987 476 882
1S71 2078 AF	1 987 476 882
1S71 2282 AD	1 987 476 883
1S71 2552 AE	0 204 001 960
1S71 2552 AE	0 204 004 551
1S71 2552 BC	0 204 004 553
1S71 2552 BE	0 204 001 962
1S71 2552 BE	0 204 004 553
1S71 2553 AE	0 204 001 959
1S71 2553 AE	0 204 004 550
1S71 2553 BC	0 204 004 552
1S71 2553 BE	0 204 001 961
1S71 2553 BE	0 204 004 552
1W1Z2 C190 AB	0 265 006 600
1X432 B372 AB	0 265 007 404
1X432 B372 AB	0 265 007 417
1X432 B372 AC	0 265 007 404
1X432 B372 AD	0 265 007 404
1X432 B372 AE	0 265 007 404
1X432 B372 AF	0 265 007 404
1X432 B372 AG	0 265 007 404
1X432 B372 BB	0 265 007 417
1X432 B372 BC	0 265 007 417
1X432 B372 BD	0 265 007 417
1X432 B372 BF	0 265 007 417
1X432 B372 BG	0 265 007 417
1X432 B507 AB	0 204 123 591
1X432 C405 CA	0 265 225 068
1X432 C405 CB	0 265 225 068
1X432 C405 CC	0 265 225 068
1X43 2005 AA	0 204 125 789
1X43 2005 AC	0 204 125 789
1X43 2005 BA	0 204 125 790
1X43 2005 BC	0 204 125 790
1000839	1 987 477 374
1001348	1 987 476 713
1001959	0 986 471 847
1002209	1 987 477 522
1004542	1 987 477 517
1005567	1 987 477 521
1005574	1 987 477 374
1006011	F 026 002 581
1006011	0 204 116 581
1006012	0 986 475 739
1006013	F 026 002 502
1006013	0 204 116 502
1006016	0 986 475 776
1010349	1 987 477 834
1010351	1 987 482 123
1010352	1 987 482 123
1011293	1 987 476 094
1011360	0 986 480 986



◀ FORD

1012023	1 987 476 599	1041774	1 987 476 815	1076426	1 987 476 176	1126850	0 204 125 767
1012024	0 204 125 500	1041775	1 987 476 821	1076707	1 987 477 929	1126851	0 204 125 769
1013455	1 987 481 114	1042122	1 987 476 603	1077950	1 987 477 374	1126960	1 987 476 882
1013482	1 987 477 833	1042338	1 987 477 345	1078043	1 987 477 521	1127096	0 204 104 261
1013815	1 987 476 441	1044230	0 204 102 865	1088016	1 987 477 931	1127931	0 265 225 170
1014204	1 987 476 600	1044234	0 204 102 600	1088017	1 987 477 930	1128924	0 265 005 236
1014214	1 987 477 520	1044234	0 204 102 863	1089128	0 986 594 023	1129032	1 987 476 447
1015244	0 986 485 129	1044239	0 204 102 864	1089437	1 987 476 615	1130711	1 987 476 179
1015246	0 986 485 130	1044504	1 987 476 715	1090097	0 265 216 701	1131657	1 987 477 517
1015248	0 986 480 679	1046069	1 987 477 521	1092259	0 986 486 055	1131729	0 265 225 170
1015249	0 986 480 995	1046070	1 987 477 521	1093544	1 987 477 836	1133215	0 204 004 553
1015250	0 986 480 678	1047260	0 986 480 927	1094179	0 204 021 807	1133216	0 204 004 552
1015251	0 986 480 698	1047659	0 204 123 355	1097285	1 987 477 930	1133294	0 265 222 016
1015252	0 986 480 697	1047660	F 026 003 354	1101841	1 987 477 931	1133294	0 265 222 031
1018615	1 987 476 619	1047660	0 204 123 577	1103617	1 987 477 521	1133442	0 986 475 739
1018642	1 987 477 345	1048296	0 204 102 923	1103618	1 987 477 836	1133522	0 986 486 066
1019240	1 987 477 374	1048298	0 204 102 922	1104131	F 026 002 502	1134140	1 987 476 886
1019627	0 204 123 482	1048764	0 204 125 531	1104132	0 986 475 776	1134815	0 204 021 807
1019628	0 204 123 194	1050100	1 987 477 836	1104481	1 987 476 176	1134816	0 204 123 701
1021839	1 987 476 816	1051091	1 987 476 095	1104956	0 265 220 468	1135855	1 987 476 840
1021841	1 987 476 817	1051093	1 987 476 098	1104957	0 265 216 625	1138611	0 204 102 923
1021861	0 986 594 023	1051514	1 987 476 811	1106077	0 986 475 905	1138612	0 204 102 922
1022453	0 204 125 499	1051516	1 987 476 812	1108004	1 987 477 374	1142139	0 265 225 170
1023692	1 987 476 601	1052957	0 265 216 625	1109678	1 987 476 816	1143926	1 987 477 933
1025018	1 987 476 602	1052957	0 265 220 468	1109679	1 987 476 817	1144076	0 204 001 960
1025055	F 026 003 548	1052959	0 265 216 625	1112271	1 987 476 840	1144076	0 204 004 551
1025055	0 204 123 548	1054014	0 261 231 124	1113641	0 986 475 750	1144077	0 204 001 962
1026118	1 987 477 731	1054047	0 986 486 055	11146400	0 265 007 879	1144077	0 204 004 553
1026327	1 987 476 603	1057438	0 204 031 289	1115018	0 265 007 087	1144078	0 204 001 961
1026895	0 204 125 491	1060213	1 987 477 521	1115018	0 265 007 879	1144078	0 204 004 552
1026898	0 204 125 492	1060214	1 987 477 836	1115528	0 265 005 236	1144079	0 204 001 959
1027516	1 987 477 522	1064257	1 987 476 884	1115985	0 986 475 751	1144079	0 204 004 550
1027745	1 987 476 382	1064284	F 026 003 608	1115986	0 986 475 752	1144400	0 261 231 162
1028404	0 986 480 919	1064284	0 204 123 608	1116840	1 987 477 734	1144924	0 265 007 125
1029361	0 204 131 184	1064291	0 986 486 066	1117106	1 987 477 733	1145295	0 986 475 926
1029361	0 204 131 362	1064455	1 987 477 522	1117731	0 265 005 414	1146400	0 265 007 087
1029544	1 987 476 604	1065070	0 265 220 495	1118772	1 987 481 153	1148270	1 987 476 885
1029545	1 987 476 605	1065085	0 265 220 495	1119026	0 265 005 303	1149168	0 265 225 170
1031616	0 986 480 679	1066801	1 987 476 817	1120604	0 265 222 031	1150333	0 204 131 695
1031617	0 986 480 697	1068762	0 204 125 491	1121359	1 987 476 170	1151027	1 987 476 994
1031618	0 986 480 995	1068763	0 204 125 492	1121635	1 987 476 883	1151292	1 987 476 179
1035269	1 987 476 604	1068964	1 987 476 852	1121810	0 204 125 766	1151332	1 987 477 517
1035270	1 987 476 605	1068975	1 987 476 887	1121869	1 987 477 734	1152437	0 204 123 613
1035693	1 987 477 345	1070828	0 265 216 701	1122329	1 987 477 734	1152438	0 204 123 614
1036199	1 987 477 834	1071938	1 987 476 626	1122458	0 204 125 500	1152713	0 204 125 767
1036201	1 987 477 835	1071939	1 987 476 602	1124751	0 265 225 170	1152714	0 204 125 769
10362209	1 987 482 123	1071940	1 987 476 095	1126532	F 026 002 581	1197814	0 265 225 170
1036229	1 987 482 123	1071941	1 987 476 098	1126532	0 204 116 581	1197962	0 204 125 799
1036230	1 987 482 123	1072752	0 265 220 468	1126711	0 204 104 259	1197964	0 204 125 800
1037718	0 986 486 055	1072754	0 265 216 625	1126716	0 204 001 958	1201141	1 987 476 993
1038224	0 986 594 024	1073151	1 987 477 929	1126717	0 204 001 957	1205576	1 987 477 932
1038834	1 987 477 836	1073706	0 986 486 067	1126842	1 987 477 734	1205735	1 987 482 132
1039745	0 986 485 129	1075806	1 987 476 815	1126844	0 204 123 578	1207358	1 987 476 058
1039747	0 986 485 130	1075807	1 987 476 821	1126845	0 204 123 579	1209852	1 987 477 906
1040745	1 987 477 374	1076417	0 986 486 050	1126849	0 204 125 768	1211024	1 987 477 732

1211411	0 265 222 031	1358881	1 987 477 734	1517559	0 986 475 776	1629399	0 204 125 208
1211729	1 987 476 057	1358882	1 987 477 733	1520230	1 987 476 471	1629401	0 204 125 045
1212748	1 987 476 882	1361292	1 987 481 159	1521632	0 204 902 027	1629959	1 987 476 381
1213135	1 987 476 058	1366384	1 987 477 222	1521636	0 204 902 026	1630040	0 986 471 912
1219402	0 265 220 495	1369542	0 204 125 845	1525881	0 265 008 287	1630135	0 986 471 911
1219695	0 265 225 170	1369543	0 204 125 846	1528034	0 265 008 128	1630359	F 026 002 339
1219805	0 986 486 067	1369797	0 204 123 614	1545647	0 204 125 857	1630359	0 204 116 339
1220462	1 987 477 906	1371407	0 204 902 027	1550233	0 204 123 807	1630360	F 026 002 338
1220591	1 987 477 733	1371412	0 204 902 026	1550240	0 204 125 936	1630360	0 204 116 338
1221411	0 265 222 016	1371482	0 265 005 690	1550242	0 204 125 937	1631045	1 987 476 504
1221411	0 265 222 031	1385739	0 986 475 927	1550243	0 204 125 934	1631046	1 987 476 505
1221413	1 987 477 990	1386268	0 265 007 879	1550245	0 204 125 935	1631047	1 987 476 508
1221742	1 987 477 734	1387264	1 987 476 181	1550255	0 204 123 806	1631048	1 987 476 506
1223475	0 986 480 994	1387272	1 987 476 180	1550274	0 204 123 788	1631049	1 987 476 507
1223483	0 986 480 994	1405497	1 987 481 159	1550276	0 204 123 789	1631051	1 987 476 509
1223491	0 986 475 927	1416442	1 987 477 216	1554476	0 986 475 005	1633071	0 204 123 717
1225678	0 265 225 267	1417345	0 265 234 355	1558834	1 987 476 267	1637322	1 987 477 229
1225679	0 265 225 170	1417346	0 265 234 354	1560029	0 986 475 826	1640542	0 204 123 097
1228027	1 987 482 121	1417349	0 265 231 704	1563530	0 986 480 631	1640544	0 986 475 058
1233321	0 204 131 709	1420259	1 987 482 188	1563561	1 987 476 267	1640551	1 987 477 365
1250828	0 265 222 031	1426690	1 987 476 057	1563597	0 265 005 607	1644433	1 987 477 230
1251281	0 204 123 614	1426700	1 987 476 058	1568860	1 987 476 138	1644434	1 987 477 229
1251699	0 204 123 613	1426701	1 987 476 994	1572002	1 987 476 471	1648810	1 987 476 420
1253158	1 987 477 932	1431308	1 987 477 222	1573041	0 204 123 716	1648811	1 987 476 606
1253159	1 987 477 933	1433955	0 204 123 717	1574611	1 987 476 262	1655850	1 987 476 512
1253162	1 987 477 906	1433956	0 204 123 716	1582113	0 986 482 013	1655851	1 987 476 513
1303858	0 265 225 170	1433960	0 204 125 857	1583215	0 986 480 631	1655853	1 987 476 614
1304007	1 987 476 170	1433963	0 204 902 027	1583479	0 986 480 621	1655854	1 987 476 615
1306698	0 986 486 066	1433964	0 204 902 026	1595646	0 986 480 327	1655952	1 987 476 515
1309224	1 987 476 180	1434147	0 204 004 618	1595762	0 986 471 651	1656491	1 987 477 367
1310482	1 987 477 517	1434148	0 204 004 617	1595763	0 986 472 651	1656647	1 987 477 095
1312641	1 987 477 345	1439905	1 987 482 133	1604645	0 986 475 611	1656793	1 987 477 229
1315748	1 987 476 066	1439906	1 987 482 134	1604748	0 204 125 039	1659671	1 987 477 095
1315749	1 987 476 066	1440658	0 265 233 342	1613083	1 987 477 298	1664643	1 987 477 232
1320552	0 265 225 267	1440659	0 265 233 341	1613085	1 987 477 020	1664703	1 987 477 300
1323555	1 987 476 419	1440660	0 265 231 705	1613087	0 986 480 465	1664958	1 987 476 104
1323641	1 987 476 181	1447430	1 987 477 734	1613337	1 987 476 381	1664962	1 987 476 616
1323904	1 987 482 189	1447432	1 987 477 733	1613343	1 987 476 267	1665932	0 204 102 407
1328519	1 987 481 179	1454040	0 265 225 395	1613344	1 987 476 262	1666247	1 987 476 608
1330300	0 204 131 709	1456989	0 986 480 994	1613345	1 987 476 276	1666294	1 987 476 607
1332884	1 987 477 734	1477378	1 987 476 066	1613346	1 987 476 381	1666344	0 986 485 119
1332885	1 987 477 733	1479582	0 265 231 912	1613347	1 987 476 467	1666345	0 986 485 090
1333956	1 987 481 170	1484750	0 986 475 776	1613348	1 987 476 263	1666460	1 987 476 608
1333957	1 987 481 171	1484751	F 026 002 581	1613349	1 987 476 266	1697687	0 204 116 145
1337130	0 265 225 340	1484751	0 204 116 504	1613350	1 987 476 008	1697688	0 204 116 146
1340832	1 987 482 122	1484751	0 204 116 581	1613351	1 987 476 420	1708505	0 986 475 832
1343668	1 987 477 906	1484752	F 026 002 502	1613463	0 986 480 502	1708513	0 986 475 831
1346641	0 265 005 639	1484752	0 204 116 502	1619118	1 987 477 350	1737066	0 986 475 815
1349853	1 987 476 182	1484766	1 987 470 020	1619137	F 026 002 339	1799276	1 987 476 475
1349854	1 987 476 182	1486316	0 986 475 776	1619137	0 204 116 339	1954519	1 987 481 122
1349905	1 987 477 990	1486750	0 986 475 776	1619189	0 986 480 609	1956496	1 987 481 101
1356387	0 204 004 378	1494893	1 987 482 036	1625132	0 204 116 355	1956522	0 986 480 952
1356388	0 204 004 379	1494895	1 987 482 035	1625702	0 986 471 932	1958315	1 987 481 119
1356393	0 204 004 380	1517558	F 026 002 502	1625703	0 986 471 931	1958316	1 987 481 122
1356394	0 204 004 381	1517558	0 204 116 502	1629323	0 204 125 046	1959359	0 986 475 759



◀ FORD

1961866	1 987 482 152	3M512 A603 CC	1 987 477 222	4X432 K407 AB	0 204 104 281	4140391	0 204 131 686
1961868	1 987 477 756	3M512 A603 DC	1 987 477 216	4041447	1 987 477 190	4140392	0 204 131 687
1961869	1 987 477 757	3M51 2078 AG	1 987 476 181	4041448	1 987 477 186	4331041	1 987 477 185
2C352 L304 AB	0 204 0A2 587	3M51 2078 AH	1 987 476 181	4041986	1 987 477 185	4331044	1 987 477 180
2M512 A635 AA	1 987 477 906	3M51 2261-AA	0 986 475 927	4041992	1 987 482 194	4331046	1 987 477 178
2N11 2078-AB	1 987 476 057	3M51 2261-AB	0 986 475 927	4041993	1 987 482 195	4366139	0 265 220 539
2N11 2078-AC	1 987 476 057	3M51 2282 EC	1 987 476 180	4041998	0 265 006 541	4387348	0 986 475 927
2N11 2282-AA	1 987 476 058	3M51 2282 ED	1 987 476 180	4041999	0 265 006 542	438874	1 987 476 077
2N11 2282-AC	1 987 476 058	3M51 2282-GB	1 987 481 179	4042001	0 265 006 458	4400343	1 987 482 035
2S61 12A699	0 261 231 162	3M51 2282-GC	1 987 481 159	4042002	0 265 006 460	4400344	1 987 477 174
2S611 2A699 AB	0 261 231 162	3M51 2282-GD	1 987 481 159	4042004	0 265 006 461	4409342	1 987 481 073
2S612 A603 AH	1 987 477 732	3M51 2853-CB	1 987 482 188	4053304	0 265 006 464	4409343	1 987 481 072
2S61 2078-AE	1 987 476 993	3R231 2A699 AB	0 261 231 045	4053305	0 265 006 465	4410751	0 204 131 688
2S61 2261 AA	0 986 475 926	3R232 C353 AB	0 265 219 537	4053869	0 265 220 487	4410752	0 204 131 689
2S61 2282-AD	1 987 476 994	3R232 C353 AC	0 265 219 535	4055730	F 026 002 578	4410759	0 204 131 690
2S61 2282-AF	1 987 476 994	3R3Z2 C190 CA	0 265 006 535	4055730	0 204 116 578	4419593	1 987 481 070
2S61 2853-AC	1 987 482 132	3S412 A603 CB	1 987 477 932	4055818	0 204 201 290	4446245	0 265 006 458
2S712 B507 AB	0 204 123 613	3S412 A603 DB	1 987 477 933	4055819	0 204 001 938	4447381	1 987 476 059
2S712 B507 AC	0 204 123 613	3S412 A635 AB	1 987 477 906	4055819	0 204 204 993	4447739	1 987 481 045
2S712 B507 BA	0 204 123 614	3S512 A603 AA	1 987 477 345	4055820	0 204 001 937	4457990	1 987 477 177
2S712 B507 BB	0 204 123 614	3S51 2078-CB	1 987 476 066	4055820	0 204 204 992	4457993	1 987 477 175
2S712 B507 BC	0 204 123 614	3S51 2078-DB	1 987 476 066	4055842	0 204 201 476	4469261	1 987 477 175
2S712 B507 BD	0 204 123 614	3S51 2078-DC	1 987 476 066	4055851	0 204 201 289	4475430	0 204 131 701
2S712 C405 BA	0 265 225 170	3S51 2282-AA	1 987 476 419	4059371	F 026 003 070	4475431	0 204 131 702
2S712 C405 DA	0 265 225 170	3S712 C405 BA	0 265 225 170	4059371	0 204 024 070	4475432	0 204 131 703
2S71 2005 AA	0 204 125 799	3S712 C405 BB	0 265 225 267	4059372	F 026 003 071	4475433	0 204 131 704
2S71 2005 AC	0 204 125 845	3S712 C405 BC	0 265 225 267	4059372	0 204 024 071	4475435	0 204 131 705
2S71 2005 BA	0 204 125 800	3S712 C405 CA	0 265 225 170	4059375	0 204 131 683	4475436	0 204 131 706
2S71 2005 BB	0 204 125 846	3S712 C405 CB	0 265 225 170	4059376	0 204 131 684	4475437	0 204 131 707
2T14 2078-AG	1 987 476 059	3S712 M110 BA	0 265 222 031	4059377	0 204 131 685	4475438	0 204 131 708
2T14 2261 AA	0 986 475 927	3W1Z2 C190 AB	0 265 006 660	4059378	0 204 131 686	4475439	0 204 131 710
2T14 2282-CA	1 987 481 168	3W1Z2 C286 BB	0 265 219 469	4059379	0 204 131 687	4475441	0 204 131 711
3C11 131 707	0 204 131 707	3W1Z2 C286 CC	0 265 219 467	4059380	0 204 131 688	4476762	0 261 231 183
3C112 B372 AA	0 265 006 784	3027144	0 261 231 143	4059382	0 204 131 689	4510813	1 987 481 168
3C112 B372 AB	0 265 006 784	325 612107 2	0 204 0A2 182	4077593	0 204 131 690	4519419	1 987 482 135
3C112 B372 AC	0 265 006 784	3395836	1 987 481 112	4090006	0 204 131 692	4519421	1 987 482 036
3C112 C285 BA	0 265 220 693	377 927807	0 265 006 218	4095181	1 987 477 174	4519422	1 987 477 174
3C112 L358 AA	0 204 131 701	3898670	1 987 476 966	4095197	0 265 006 686	4519465	1 987 481 166
3C112 L358 BA	0 204 131 702	3943759	0 261 231 119	4099156	0 265 006 458	4519466	1 987 481 167
3C112 L358 CA	0 204 131 703	3991033	0 261 231 138	4099157	0 265 006 460	4522490	0 265 006 811
3C112 L358 DA	0 204 131 704	4C352 L304 BA	0 204 0A2 586	4104652	0 204 024 181	4522491	0 265 006 812
3C112 L358 EA	0 204 131 705	4F132 C190 AA	0 265 007 589	4109876	0 265 006 687	4525694	F 026 003 070
3C112 L358 FA	0 204 131 706	4F132 C190 BA	0 265 007 591	4115753	0 265 220 487	4525694	0 204 024 070
3C112 L358 GA	0 204 131 707	4F132 C216 BA	0 265 007 590	4118722	0 204 131 691	4525696	F 026 003 071
3C112 L358 HA	0 204 131 708	4L3A1 2A699 AA	0 261 231 183	4118723	0 204 131 693	4525696	0 204 024 071
3C112 L358 JA	0 204 131 709	4N11 2282-AA	1 987 481 170	4120171	0 265 220 539	4525702	0 204 131 713
3C112 L358 KA	0 204 131 710	4N11 2282-BA	1 987 481 171	4120677	1 987 482 035	4531952	0 204 024 692
3C112 L358 LA	0 204 131 711	4S7T1 4B296 AA	0 265 005 639	4120808	0 265 219 475	4533632	0 265 006 814
3C112 L358 MB	0 204 131 712	4S712 C405 BA	0 265 225 340	4122075	1 987 477 178	4533633	0 265 006 813
3C112 L358 MC	0 204 131 713	4S712 C405 CA	0 265 225 395	4122466	0 204 131 694	4537232	0 265 216 999
3C112 M110 BA	0 265 216 999	4S71 2552 AA	0 204 004 379	4122482	0 204 131 696	4537233	0 265 220 693
3C11 2005 AA	0 204 024 692	4S71 2552 BA	0 204 004 381	4131399	0 265 006 541	4537234	0 265 006 815
3C11 2078 AE	1 987 481 047	4S71 2553 AA	0 204 004 378	4131400	0 265 006 687	4537235	0 265 006 816
3C11 2078 BD	1 987 481 046	4S71 2553 BA	0 204 004 380	4140389	0 204 131 692	4537236	0 265 006 817
3M51 2A603-BP	1 987 482 189	4X432 K407 AA	0 204 104 281	4140390	0 204 131 685	4537237	0 265 006 818

4537240	0 265 006 784
4540494	0 265 006 458
4577323	0 265 006 817
4583026	0 265 006 818
46211 0F005	1 987 481 101
4639309	1 987 482 036
4654291	1 987 477 177
4659007	1 987 481 047
4659020	1 987 481 046
4661143	0 204 104 281
4861620	0 204 104 281
5L552 D150 AA	0 204 0A2 573
5023217	0 986 471 651
5023218	0 986 472 651
5023222	0 986 47A 893
5023222	0 986 473 893
5023225	0 986 471 833
5023225	0 986 472 661
5023226	0 986 471 700
5023226	0 986 471 832
5023231	0 986 471 932
5023232	0 986 471 931
528658	1 987 476 061
558087	0 986 475 115
6C11 V107T00-BA	F 026 002 502
6C11 V107T00-BA	0 204 116 502
6C112 B120 AC	0 204 004 616
6C112 B120 BA	0 204 004 618
6C112 B121 AC	0 204 004 615
6C112 B121 BA	0 204 004 617
6C112 C285 CC	0 265 233 342
6C112 C285 DC	0 265 233 341
6C112 C405 CB	0 265 234 355
6C112 C405 DB	0 265 234 354
6C11 2K478 AC	0 204 123 717
6C11 2K478 AD	0 204 123 717
6C11 2K478 BC	0 204 123 716
6C11 2K478 BD	0 204 123 716
6C112 M110 CD	0 265 231 705
6C112 M110 DC	0 265 231 704
6C11 2005 BC	0 204 125 857
6C11 2005 BD	0 204 125 857
6C11 2552 AC	0 204 004 620
6C11 2552 AC	0 204 902 027
6C11 2552 AD	0 204 902 027
6C11 2553 AC	0 204 004 619
6C11 2553 AC	0 204 902 026
6C11 2553 AD	0 204 902 026
6C113 C190 AB	0 265 005 690
6S432 B507 AA	0 204 123 699
6S432 B507 CA	0 204 123 701
6W1Z 2C190 A	0 265 006 829
6009659	F 026 002 581
6009659	0 204 116 581
6011798	1 987 476 138

6019656	0 986 480 631
6023398	0 986 475 500
6023399	0 986 475 425
6025668	0 986 475 424
6028053	0 986 475 813
6035875	F 026 002 105
6035875	0 204 116 105
6040610	1 987 477 015
6041419	1 987 477 013
6045647	0 986 482 018
6045898	0 986 471 651
6045899	0 986 472 651
6046019	0 986 475 819
6046022	0 986 475 820
6046469	0 986 480 465
6048437	1 987 477 100
6048438	1 987 477 100
6049290	1 987 477 099
6049556	1 987 476 263
6050436	1 987 476 262
6050437	1 987 476 262
6056818	1 987 477 360
6056822	1 987 477 015
6057063	0 986 480 465
6057398	0 986 480 327
6057399	0 986 480 327
6057402	1 987 476 266
6057572	1 987 477 017
6061184	1 987 476 276
6063234	F 026 002 105
6063234	0 204 116 105
6067713	0 986 480 465
6067714	0 986 480 614
6067715	0 986 480 465
6069633	0 986 480 631
6069636	0 986 480 631
6069637	0 986 480 631
6073100	1 987 476 008
6079641	0 986 475 813
6079642	F 026 002 105
6079642	0 204 116 105
6081237	0 986 480 336
6081825	1 987 477 020
6083866	0 204 123 038
6083869	0 204 123 037
6085217	1 987 476 262
6088076	0 986 480 649
6088077	0 986 480 649
6088234	0 986 475 739
6089688	0 204 125 025
6090605	F 026 002 105
6090605	0 204 116 105
6090606	0 204 116 329
6090943	0 986 471 908
6090945	0 986 471 907

6092734	1 987 477 019
6094081	1 987 477 361
6095650	1 987 476 381
6096066	F 026 002 106
6096066	0 204 116 106
6102078	0 204 123 063
6103017	0 986 480 649
6103018	0 986 480 649
6106584	0 986 475 776
6107104	0 986 480 613
6107581	1 987 476 420
6107582	1 987 476 606
6109873	1 987 477 020
6109874	1 987 477 019
6112650	0 986 482 019
6112651	0 986 482 020
6112877	1 987 477 020
6112878	1 987 477 298
6114613	1 987 476 021
6117971	1 987 477 230
6118138	0 986 480 619
6118141	0 204 123 471
6118142	0 204 123 472
6118143	0 204 123 470
6118144	0 204 123 066
6120901	1 987 477 230
6121621	0 986 471 912
6121622	0 986 471 908
6121626	0 986 471 907
6121706	0 986 471 911
6122806	1 987 477 020
6122807	1 987 477 019
6122831	0 986 471 932
6122832	0 986 471 931
6123361	0 986 480 609
6125634	1 987 476 407
6125636	1 987 476 022
6126854	1 987 476 382
6129003	1 987 476 613
6129448	0 986 480 611
6129449	0 986 480 611
6130487	0 986 471 908
6130488	0 986 471 908
6130489	0 986 471 912
6130490	0 986 471 907
6130491	0 986 471 907
6130493	0 986 471 911
6130714	1 987 477 020
6130715	1 987 477 019
6131133	1 987 477 362
6131134	1 987 477 363
6131482	0 986 480 611
6132910	1 987 476 382
6134735	0 986 471 894
6134736	0 986 471 893

6135220	1 987 476 023
6136543	0 204 123 475
6136543	0 986 480 057
6136544	0 204 123 086
6136834	0 204 123 473
6136836	0 986 480 124
6136837	0 986 480 124
6137663	1 987 477 020
6139438	1 987 477 230
6139442	1 987 477 302
6139443	1 987 477 365
6141433	1 987 477 093
6142527	1 987 476 512
6142528	1 987 476 513
6142529	1 987 476 514
6142530	1 987 476 515
6143445	0 986 471 908
6143447	0 986 471 912
6143449	0 986 471 894
6143451	0 986 471 932
6143453	0 986 471 907
6143455	0 986 471 911
6143457	0 986 471 893
6143459	0 986 471 931
6145457	0 986 471 908
6145459	0 986 471 907
6149181	1 987 476 614
6149182	1 987 476 615
6150106	0 986 475 742
6150108	0 986 475 701
6150109	0 986 475 704
6150110	0 986 475 821
6150111	0 986 475 702
6150112	0 986 475 703
6150113	0 986 475 822
6150950	0 204 104 135
6151043	0 204 123 077
6151044	F 026 003 084
6151044	0 204 123 084
6151045	0 204 123 083
6151046	F 026 003 085
6151046	0 204 123 085
6151054	0 204 125 051
6151055	0 204 125 052
6151057	0 986 485 086
6151059	0 986 485 087
6152221	0 986 471 833
6152221	0 986 472 661
6152222	0 986 471 833
6152222	0 986 472 661
6152223	0 986 471 700
6152223	0 986 471 832
6152224	0 986 471 661
6152224	0 986 471 832
6152883	0 261 231 001



◀ FORD

6152883	0 261 231 006	6187601	0 204 116 398	6658706	1 987 477 369	6913016	0 204 131 369
6154068	0 986 471 932	6187602	F 026 002 401	6658707	1 987 477 370	6913017	0 204 131 358
6154070	0 986 471 931	6187602	0 204 116 401	6658751	1 987 477 096	6913018	0 204 131 680
6154286	1 987 477 097	6188428	0 986 471 910	6667473	1 987 476 607	6920298	1 987 477 232
6155003	0 986 480 843	6188429	0 986 471 909	6668590	0 986 471 934	6920299	1 987 477 372
6158200	1 987 477 236	6189159	0 986 471 912	6668591	0 986 471 936	6922548	F 026 003 594
6158201	1 987 477 094	6189161	0 986 471 932	6668592	0 986 471 933	6922548	0 204 123 594
6158424	1 987 476 510	6189162	0 986 471 911	6668593	0 986 471 935	6922548	0 986 480 127
6158425	1 987 476 511	6189164	0 986 471 931	6669768	0 204 102 272	6922549	0 204 123 402
6158711	1 987 477 366	6189617	0 204 031 289	6669769	0 204 102 271	6922621	1 987 476 625
6159054	1 987 477 227	6191842	1 987 476 441	6669769	0 204 102 859	6941702	1 987 476 568
6161952	1 987 477 236	6194541	1 987 477 230	6676122	1 987 477 300	6941703	1 987 476 566
6161953	1 987 477 094	6194542	1 987 477 097	6676123	1 987 477 300	6941704	1 987 476 567
6163735	1 987 477 227	6196051	F 026 002 581	6676124	1 987 477 234	6941705	1 987 476 565
6164952	F 026 002 144	6196051	0 204 116 581	6700131	0 204 102 274	6942039	0 986 485 120
6164952	0 204 116 144	6196052	0 986 475 776	6714709	1 987 476 104	6944442	1 987 477 836
6166968	1 987 477 102	6196053	0 986 475 739	6714710	1 987 481 097	6960026	1 987 476 626
6166969	1 987 477 103	6197106	0 986 471 912	6723389	1 987 477 233	6974959	0 204 123 194
6168200	1 987 477 236	6197740	0 204 102 409	6754692	F 026 003 136	7C1V 2M110 CA	0 265 231 912
6168201	1 987 477 094	6197740	0 204 102 925	6754692	0 204 123 136	7G9N 3C529 AD	0 986 475 776
6168203	1 987 477 097	6197741	0 204 102 934	6754695	0 204 125 068	7X43 2K478 AB	0 204 123 762
6169520	1 987 477 228	6197742	0 204 102 410	6758577	1 987 476 626	7X43 2005 AB	0 204 125 895
6169571	0 261 231 006	6197742	0 204 102 926	6758585	1 987 476 562	7X43 2005 BB	0 204 125 896
6170667	0 986 480 125	6197743	0 204 102 935	6758586	1 987 476 563	7030690	1 987 477 631
6170668	0 986 480 677	6464704	F 026 002 172	6758587	1 987 476 622	7034902	F 026 003 136
6171464	1 987 477 101	6464704	0 204 116 172	6781601	0 204 123 194	7034902	0 204 123 158
6173278	0 986 480 126	6464705	F 026 002 171	6785736	1 987 477 234	7034906	0 204 125 101
6176621	0 986 471 898	6464705	0 204 116 171	6789916	0 986 486 055	7034907	0 204 125 127
6176623	0 986 471 897	6464706	F 026 002 173	6808555	0 986 475 750	7043631	1 987 477 374
6177471	0 204 125 064	6464706	0 204 116 173	6808556	0 986 475 751	7067563	1 987 476 626
6179304	1 987 476 382	6483797	1 987 476 568	6808557	0 986 475 752	7088322	0 986 480 940
6180375	0 204 104 161	6483798	1 987 476 567	6823334	1 987 476 623	7091549	1 987 476 433
6180378	0 204 102 406	6490376	1 987 476 616	6823335	1 987 476 624	7100747	0 204 125 071
6180378	0 204 102 924	6502746	1 987 477 367	6828211	1 987 476 607	7100750	F 026 003 594
6180380	0 204 102 931	6510341	1 987 476 568	6842331	F 026 003 594	7100750	0 204 123 594
6182594	0 986 482 010	6510342	1 987 476 567	6842331	0 204 123 594	7100750	0 986 480 127
6182643	0 986 475 824	6513464	0 986 471 833	6842331	0 986 480 127	7100751	0 204 123 402
6182644	0 986 475 825	6513466	0 986 471 832	6842332	0 204 123 402	7111981	1 987 476 184
6184721	1 987 476 510	6535451	1 987 476 617	6854705	1 987 477 374	7111983	1 987 481 113
6184722	1 987 476 511	6535452	1 987 476 618	6869978	0 204 031 294	7117257	F 026 002 397
6184723	1 987 476 514	6569119	1 987 476 441	6881658	1 987 476 568	7117257	0 204 116 397
6185938	0 204 125 074	6577423	1 987 476 510	6881659	1 987 476 566	7117258	0 986 480 973
6185939	0 204 125 075	6577424	1 987 476 511	6881660	1 987 476 567	7117261	0 986 480 972
6185940	0 204 123 477	6577425	1 987 476 614	6881661	1 987 476 565	72GB 2261 AA	0 986 475 776
6186005	0 986 480 608	6577426	1 987 476 615	6912221	1 987 477 300	72GB 2261 BA	F 026 002 502
6187159	0 986 471 912	6579149	0 204 110 512	6913007	0 204 131 354	72GB 2261 BA	0 204 116 502
6187312	0 986 471 908	6581520	F 026 003 594	6913008	0 204 131 359	72GB 2261 CA	F 026 002 581
6187313	0 986 471 912	6581520	0 204 123 594	6913009	0 204 031 299	72GB 2261 CA	0 204 116 504
6187315	0 986 471 894	6581520	0 986 480 127	6913010	0 204 131 367	72GB 2261 CA	0 204 116 581
6187317	0 986 471 907	6597017	0 204 123 114	6913011	0 204 131 072	7200918	0 986 480 930
6187318	0 986 471 911	6637334	1 987 477 300	6913011	0 204 131 356	7200919	0 986 480 930
6187320	0 986 471 893	6643690	1 987 476 619	6913012	0 204 131 368	7200920	0 986 480 933
6187600	F 026 002 396	6645754	0 986 480 661	6913013	0 204 031 298	7201624	1 987 477 630
6187600	0 204 116 396	6657327	1 987 476 620	6913014	0 204 131 360	7217916	1 987 476 441
6187601	F 026 002 398	6657328	1 987 476 621	6913015	0 204 131 366	7253664	1 987 477 735

7264793	1 987 477 631
7272225	1 987 476 607
7281468	0 204 123 599
7281469	0 204 123 600
7291998	1 987 477 833

7307485	1 987 476 185
7328444	1 987 476 715
7335770	1 987 476 714
7335771	1 987 476 713
7376434	1 987 477 735

74BB 2261 AC	0 986 475 813
7402895	1 987 476 627
7402911	1 987 477 835
7402912	1 987 477 834
7402914	1 987 482 123

77FB 2A604 AF	1 987 477 360
77FB 2A82 3AA	1 987 477 015
77FB 2A82 3AC	1 987 477 015
77FB 2L231 DF1	0 986 473 651
77FB 2L232 DF1	0 986 474 651

77FB 2078 DB	1 987 476 262
77FB 2078 DC	1 987 476 262
77FB 2140 AHB	0 986 480 614
77FB 2140 ALA	0 986 480 465
77FB 2261 AB	F 026 002 105

77FB 2261 AB	0 204 116 105
77FB 2261 AD	F 026 002 105
77FB 2261 AD	0 204 116 105
77FB 2261 BD	0 204 116 329
77FB 2282 KC	1 987 476 263

77FB 2853 AG	1 987 477 361
77FX 2N118 DF1	0 986 473 651
77FX 2N119 DF1	0 986 474 651
77VB 2A604 C1D	1 987 477 099
77VB 2A604 D1C	1 987 477 100

7701966	0 265 006 482
78GB 2A603 A3E	1 987 477 017
78GB 2140 BA	0 986 480 327
78VB 2L358 AC	0 986 482 019
78VB 2L358 BC	0 986 482 020

8T1T 14K733-MCA	0 265 008 287
8V512 B372 AC	0 265 008 287
8V512 C204 AC	0 265 008 128
8V51 2002 AA	0 204 125 936
8V51 2002 BA	0 204 125 937

8V51 2002 CA	0 204 125 934
8V51 2002 DA	0 204 125 935
8V51 2140 AA	0 204 123 806
8V51 2140 BA	0 204 123 807
8V51 2140 CA	0 204 123 788

8V51 2140 DA	0 204 123 789
8W132 C190 AA	0 265 006 836
8W132 C190 BA	0 265 006 837
80AB 2L232 EB	0 986 471 911
80BB 2140 AA	0 204 123 063

80VB 2A032 AA	0 204 123 038
80VB 2A032 EA	0 204 123 037
81AB 2A60 4AB	1 987 477 020
81AB 2A60 4AC	1 987 477 020
81AB 2A60 4AD	1 987 477 020

81AB 2A60 4AE	1 987 477 020
81AB 2A60 4AF	1 987 477 020
81AB 2A604 BD	1 987 477 298
81AB 2A604 BE	1 987 477 298
81AB 2A82 3AB	1 987 477 019

81AB 2A82 3AC	1 987 477 019
81AB 2A82 3AE	1 987 477 019
81AB 2A82 3BA	1 987 477 019
81AB 2L231 EB	0 986 471 912
81AB 2005 BB	0 204 125 025

81AB 2140A 1B	0 986 480 649
81AB 2140A 1C	0 986 480 649
81AB 2140A 2C	0 986 480 649
81AB 2140 BB	0 986 480 336
81AB 2261 AA	0 986 475 739

81AB 2282 BB	1 987 476 008
81AB 2282 FB	1 987 476 420
81AB 2282 GA	1 987 476 606
82AB 2L231 BA	0 986 471 908
82AB 2L231 BB	0 986 471 908

82AB 2L231 BC	0 986 471 908
82AB 2L231 DA	0 986 471 911
82AB 2L231 DB	0 986 471 911
82AB 2L231 DC	0 986 471 912
82AB 2L232 BA	0 986 471 907

82AB 2L232 BB	0 986 471 907
82AB 2L232 BC	0 986 471 907
82AB 2L232 DA	0 986 471 912
82AB 2L232 DB	0 986 471 911
82AB 2L232 DC	0 986 471 911

82GB 2140 AA	0 986 480 613
83AB 2A603 AA	1 987 477 093
83AB 2A603 AD	1 987 477 366
83AB 2A60 3AF	1 987 477 236
83AB 2A60 3BF	1 987 477 094

83AB 2A60 4BA	1 987 477 020
83AB 2A60 4BB	1 987 477 020
83AB 2A604 CA	1 987 477 362
83AB 2A823 BA	1 987 477 019
83AB 2A823 BB	1 987 477 302

83AB 2A823 CA	1 987 477 363
83AB 2A823 CB	1 987 477 365
83BB 2A603 AE	1 987 477 230
83BB 2A60 3AF	1 987 477 230
83BB 2A60 3AG	1 987 477 230

83BB 2A60 3AH	1 987 477 230
83BB 2L231 CD	0 986 471 932
83BB 2L232 CD	0 986 471 931
83BB 2078 AC	1 987 476 381
83BB 2140 KA	0 986 480 619

83BB 2140 NA	0 204 123 471
83BB 2140 SA	0 204 123 470
83BB 2140 TA	0 204 123 066
83BB 2261 BA	F 026 002 106
83BB 2261 BA	0 204 116 106

83BB 2282 AD	1 987 476 382
83BB 2282 AE	1 987 476 382
84AB 2078 AA	1 987 476 023
84FB 2A60 3AG	1 987 477 227
84FB 2A60 3AJ	1 987 477 228

84FB 2A603 AL	1 987 477 228
84FB 2005 A2B	0 204 125 208
84FB 2078 AA	1 987 476 021
84FB 2140 AA	0 986 480 502
84FB 2140 BA	0 986 480 609

84FB 2140 DB	0 986 480 611
84FB 2140 EB	0 986 480 611
84FB 2261 AC	F 026 002 339
84FB 2261 AC	0 204 116 339
84FB 2261 BC	F 026 002 338

84FB 2261 BC	0 204 116 338
84FB 2853 AA	1 987 477 350
85AB 2005 AA	0 204 125 046
85AB 2005 AB	0 204 125 046
85AB 2005 BB	0 204 125 045

85AB 2140 AA	0 204 123 473
85AB 2140 CA	0 986 480 124
85AB 2140 DA	0 986 480 124
85FB 2140 AA	0 986 480 611
85GB 16A038 CB1TM	1 987 477 095

85GB 2A60 3AE	1 987 477 097
85GB 2A60 3AG	1 987 477 097
85GB 2L232 BB	0 986 471 931
85GB 2L590 AD	0 986 471 833
85GB 2L590 BD	0 986 471 833

85GB 2L590 BD	0 986 472 661
85GB 2L591 AD	0 986 471 700
85GB 2078 AA	1 987 476 407
85GB 2140 CA	0 986 480 843
85GB 2282 AA	1 987 476 022

85GX 2N118 AD	0 986 471 833
85GX 2N119 AD	0 986 471 700
8557388	0 204 131 002
86AB 2140 AA	0 204 123 475
86AB 2140 BA	0 204 123 086

86SF 12A699 AA	0 261 231 001
86SF 12A699 AB	0 261 231 006
86VB 2A032 AA	0 204 123 077
86VB 2A032 BA	F 026 003 084
86VB 2A032 BA	0 204 123 084

86VB 2A032 CA	0 204 123 083
86VB 2A032 DA	F 026 003 085
86VB 2A032 DA	0 204 123 085
86VB2 A159 AA	0 204 125 051
86VB 2A159 BA	0 204 125 052

86VB 2A159 DA	0 986 485 086
86VB 2A159 FA	0 986 485 087
86VB 2A604 BE	1 987 477 102
86VB 2A604 CE	1 987 477 103
86VB 2B107 AA	0 204 104 135

86VB 2078 AC	1 987 476 510
86VB 2078 BC	1 987 476 511
86VB 2078 CA	1 987 476 512
86VB 2078 DA	1 987 476 513
86VB 2078 EA	1 987 476 514

86VB 2078 FA	1 987 476 515
86VB 2261 AA	0 986 475 742
86VB 2261 CA	0 986 475 701
86VB 2261 DA	0 986 475 704
86VB 2261 EA	0 986 475 821

86VB 2262 CA	0 986 475 702
86VB 2262 DA	0 986 475 703
86VB 2262 EA	0 986 475 822
86VB 2282 BB	1 987 476 614
86VB 2282 CB	1 987 476 615

87AB 2282 AA	1 987 476 606
87AB 2282 BA	1 987 476 420
87BB 2261 AA	F 026 002 144
87BB 2261 AA	0 204 116 144
87VB 2853 AA	1 987 477 101

88AB 2L231 AA	0 986 471 908
88AB 2L231 BA	0 986 471 912
88AB 2L232 AA	0 986 471 907
88AB 2L232 BA	0 986 471 911
88BB 2L231 CA	0 986 471 911

88BB 2L231 EA	0 986 471 932
88BB 2L232 CA	0 986 471 912
88BB 2140 BA	0 986 480 608
88BB 2140 CB	0 204 123 114
88BX 2N118 EA	0 986 471 932

88BX 2N119 EA	0 986 471 931
88FB 2L231 AA	0 986 471 894
88FB 2L231 BA	0 986 478 765
88FB 2L231 BA	0 986 474 765
88FB 2L232 AA	0 986 471 893

88FB 2L232 BA	0 986 478 764
88FB 2L232 BA	0 986 474 764
88PB 2005 AA	0 204 125 064
88VB 2261 AA	0 986 475 824
88VB 2262 AA	0 986 475 825

89AB 2005 AA	0 204 125 074
89AB 2005 BA	0 204 125 075
89AB 2140 AA	0 204 123 477
89FB 2A60 3AJ	1 987 477 096
89FB 2L231 BC	0 986 47A 910

89FB 2L231 BC	0 986 473 910
89FB 2L232 BC	0 986 47A 909
89FB 2L232 BC	0 986 473 909
89FB 2005 AC	0 986 485 119
89FB 2005 BC	0 986 485 090



◀ FORD

89FB 2078 AH	1 987 476 441
89FB 2140 AA	0 986 480 125
89FB 2140 BA	0 986 480 677
89FB 2140 CA	0 986 480 126
89FB 2261 AB	F 026 002 396

89FB 2261 AB	0 204 116 396
89FB 2261 CB	F 026 002 398
89FB 2261 CB	0 204 116 398
89FB 2261 EA	F 026 002 401
89FB 2261 EA	0 204 116 401

89FB 2282 AB	1 987 476 382
89FB 2853 AB	1 987 477 367
89FB 2853 AC	1 987 477 367
89VB 2L358 AA	0 986 482 010
95S1 3C187 AA	0 265 005 607

91AB 2A603 AK	1 987 477 300
91AB 2A603 CG	1 987 477 234
91AB 2B107 AA	0 204 104 161
91AB 2B110 BB	1 987 476 567
91AB 2B294 BA	0 204 102 406

91AB 2B294 BA	0 204 102 924
91AB 2B302 BA	0 204 102 931
91AB 2L304 CA	0 204 031 289
91AB 2005 FB	0 204 125 071
91AB 2140 EA	F 026 003 594

91AB 2140 EA	0 204 123 594
91AB 2140 ED	F 026 003 594
91AB 2140 ED	0 204 123 594
91AB 2140 FA	0 204 123 402
91AB 2140 FC	0 204 123 402

91AB 2140 FD	0 204 123 402
91AB 2282 AE	1 987 476 607
91AB 2282 CC	1 987 476 104
92AB 2A603 AA	1 987 477 232
92AB 2078 AB	1 987 476 568

92AB 2078 AC	1 987 476 184
92AB 2078 BB	1 987 476 566
92AB 2078 CB	1 987 476 567
92AB 2078 DB	1 987 476 565
92AB 2282 AB	1 987 476 623

92AB 2282 BB	1 987 476 624
92FB 2A603 AD	1 987 477 233
92FB 2A603 BA	1 987 477 372
92FB 2L358 AE	0 204 031 294
92FB 2L358 AF	0 204 031 294

92FB 2140 BA	0 986 480 661
92FB 2282 AE	1 987 476 619
92GB 2552 BA	0 986 471 833
92VB 2A159 AA	0 204 125 068
92VB 2B120 AA	0 204 102 409

92VB 2B120 AA	0 204 102 925
92VB 2B120 BA	0 204 102 934
92VB 2B121 AA	0 204 102 410
92VB 2B121 AA	0 204 102 926
92VB 2B121 BA	0 204 102 935

92VB 2004 AA	F 026 003 136
92VB 2004 AA	0 204 123 136
92VB 2078 AA	1 987 476 510
92VB 2078 BA	1 987 476 511
92VB 2128 DA	0 204 110 512

92VB 2261 AA	F 026 002 172
92VB 2261 AA	0 204 116 172
92VB 2261 BA	F 026 002 171
92VB 2261 BA	0 204 116 171
92VB 2261 CA	F 026 002 173

92VB 2261 CA	0 204 116 173
92VB 2282 AA	1 987 476 614
92VB 2282 BA	1 987 476 615
92VB 2282 BB	1 987 476 615
92VB 2853 AD	1 987 477 369

92VB 2853 CD	1 987 477 370
92VR 2853 AD	1 987 477 369
92VR 2853 CD	1 987 477 370
93AB 2140 BA	0 204 123 600
93BB 2A603 AF	1 987 477 631

93BB 2A809 BJ	1 987 477 836
93BB 2A809 DJ	1 987 477 374
93BB 2A809 DM	1 987 477 374
93BB 2B507 BB	0 204 123 194
93BB 2K327 CK	0 204 102 925

93BB 2L231 AA	0 986 471 934
93BB 2L231 BA	0 986 471 936
93BB 2L232 AA	0 986 471 933
93BB 2078 AD	1 987 476 626
93BB 2078 AE	1 987 476 626

93BB 2261 BC	0 986 475 750
93BB 2261 BD	0 986 475 750
93BB 2261 DC	0 986 475 751
93BB 2261 DD	0 986 475 751
93BB 2261 EC	0 986 475 752

93BB 2261 ED	0 986 475 752
93BB 2282 AA	1 987 476 562
93BB 2282 BB	1 987 476 563
93BB 2282 CA	1 987 476 622
93BB 2282 DD	1 987 476 625

93BB 2552 AA	0 204 102 272
93BB 2552 BC	0 204 102 865
93BB 2552 BE	0 204 103 865
93BB 2553 AA	0 204 102 271
93BB 2553 AA	0 204 102 859

93BB 2553 AC	0 204 102 600
93BB 2553 AC	0 204 102 863
93BB 2553 BA	0 204 102 274
93BB 2553 BC	0 204 102 864
93BB 2553 BE	0 204 103 864

93VB 2L358 AA	0 204 131 354
93VB 2L358 AA	0 204 131 367
93VB 2L358 BA	0 204 131 359
93VB 2L358 CA	0 204 031 299
93VB 2L358 DA	0 204 131 367

93VB 2L358 EA	0 204 131 072
93VB 2L358 EA	0 204 131 356
93VB 2L358 FA	0 204 131 368
93VB 2L358 GA	0 204 031 298
93VB 2L358 HA	0 204 131 360

93VB 2L358 JA	0 204 131 366
93VB 2L358 KA	0 204 131 369
93VB 2L358 LA	0 204 131 358
93VB 2L358 MA	0 204 131 680
94BB 2A809 AE	1 987 477 521

94BB 2A809 BJ	1 987 477 836
94BB 2A809 BK	1 987 477 836
94BB 2B507 AA	0 204 123 194
94BB 7A54 3AA	0 986 486 055
94BB 7A54 3AB	0 986 486 055

94BB 7A54 3AC	0 986 486 055
94BB 7A54 3AD	0 986 486 055
94FB 2005 AA	0 986 485 120
94FB 2140 AB	0 986 480 973
94FB 2140 DB	0 986 480 972

94FB 2261 AA	F 026 002 397
94FB 2261 AA	F 026 002 581
94FB 2261 AA	0 204 116 397
94FB 2261 AA	0 204 116 581
94VB 2005 AA	0 204 125 101

94VB 2005 CA	0 204 125 127
94VB 2140 AB	0 204 123 158
95AB 2A603 AC	1 987 477 835
95AB 2A603 AE	1 987 477 835
95AB 2A603 BC	1 987 477 834

95AB 2A603 BE	1 987 477 834
95AB 2078 BD	1 987 476 821
95AB 2140 AA	0 204 123 599
95AB 2140 BA	0 204 123 600
95AB 2261 AA	F 026 002 581

95AB 2261 AA	0 204 116 581
95AB 2261 BA	0 986 475 739
95AB 2261 B1	0 986 475 739
95AB 2282 CB	1 987 476 627
95AB 2853 AA	1 987 477 522

95AB 2853 AC	1 987 477 522
95AB 2853 AD	1 987 477 522
95BB 2282 BA	1 987 476 599
95GB 2A603 AD	1 987 477 735
95GB 2B507 AA	0 986 480 940

95GB 2078 AA	1 987 476 433
95GB 2282 AC	1 987 476 185
95VW 2A603 AC	1 987 477 630
95VW 2A604 AC	1 987 477 833
95VW 2B1118 CA	0 986 471 847

95VW 2078 AE	1 987 476 713
95VW 2078 BA	1 987 476 713
95VW 2140 AA	0 986 480 930
95VW 2140 BA	0 986 480 930
95VW 2140 CA	0 986 480 933

95VW 2282 AD	1 987 476 714
95VW 2282 BB	1 987 476 715
95VW 2282 BC	1 987 476 715
95VW 7A543 BD	0 986 486 050
96AB 2B507 AE	0 986 480 986

96AB 2282 AB	1 987 476 094
96BG 2M110 BB	0 265 216 701
96DA 2C204 AA	0 265 006 230
96FB 2A603 AG	1 987 477 345
96FB 2A603 BE	1 987 477 520

96FB 2A603 BG	1 987 477 521
96FB 2B372 BD	0 986 594 023
96FB 2B372 BE	0 986 594 023
96FB 2L231 BA	0 986 47A 910
96FB 2L231 BA	0 986 473 910

96FB 2L232 BA	0 986 47A 909
96FB 2L232 BA	0 986 473 909
96FB 2L352 AC	0 204 131 184
96FB 2L352 AC	0 204 131 362
96FB 2005 EF	0 986 485 129

96FB 2005 EF	0 986 485 130
96FB 2005 GE	0 986 485 130
96FB 2005-GF	0 986 485 130
96FB 2078 BG	1 987 476 816
96FB 2078 CG	1 987 476 817

96FB 2078 DA	1 987 476 441
96FB 2078 JA	1 987 476 817
96FB 2140 BE	0 986 480 679
96FB2140DE	0 986 480 995
96FB 2140 EE	0 986 480 678

96FB 2140 HA	0 986 480 698
96FB 2140 JA	0 986 480 697
96FB 2261 AA	F 026 002 502
96FB 2261 AA	0 204 116 502
96FB 2261 BA	0 986 475 776

96FB 2282 AC	1 987 476 600
96FB 2282 BA	1 987 476 619
96FB 2853 AA	1 987 477 517
96GG 2A603 AB	1 987 477 731
97AG 2B294 BA	0 204 102 923

97AG 2B302 BA	0 204 102 922
97AG 2L304 CA	0 204 031 289
97AG 2078 AA	1 987 476 811
97AG 2078 BA	1 987 476 812
97AG 2078 CA	1 987 476 815

97AG 2078 DA	1 987 476 821
97BB 2B507 AA	0 204 123 482
97BB 2B507 BA	0 204 123 194
97BB 2B507 CA	F 026 003 548
97BB 2B507 CA	0 204 123 548

97BB 2005 AA	0 204 125 500
97BB 2005 AB	0 204 125 500
97BB 2005 BA	0 204 125 499
97BB 2005 CA	0 204 125 491
97BB 2005 CB	0 204 125 491

97BB 2005 DA	0 204 125 492
97BB 2005 DB	0 204 125 492
97BG 2A809 AA	1 987 477 521
97BG 2A809 CA	1 987 477 521
97BG 2C338 AA	1 987 476 095

97BG 2C338 AB	1 987 476 095
97BG 2C339 AA	1 987 476 098
97BG 2C339 AB	1 987 476 098
97BG 2282 AA	1 987 476 601
97BG 2282 BB	1 987 476 602

97BG 2282 BC	1 987 476 602
97KB 2A603 AC	1 987 477 345
97KB 2078 BB	1 987 476 604
97KB 2078 CB	1 987 476 605
97KB 2140 AB	0 986 480 919

97KB 2140 CB	0 986 480 927
97KB 2282 AA	1 987 476 603
97KB 2282 AB	1 987 476 603
97KG 2B372 AA	0 986 594 024
98AB 2B507 AB	F 026 003 608

98AB 2B507 AB	0 204 123 608
98AB 2B507 BB	0 204 021 807
98AB 2B507 BC	0 204 021 807
98AB 2B507 BD	0 204 123 700
98AB 2B507 CA	0 204 123 701

98AB7A543AF	0 986 486 066
98AG 2A603 AL	1 987 477 930
98AG 2A603 AM	1 987 477 930
98AG 2A603 AN	1 987 477 932
98AG 2A603 BJ	1 987 477 931

98AG 2A603 BK	1 987 477 931
98AG 2A603 BL	1 987 477 933
98AG 2A635 AE	1 987 477 906
98AG 2078 AD	1 987 476 852
98AG 2078 AE	1 987 476 886

98AG 2282 AB	1 987 476 884
98AG 2282 CB	1 987 476 887
98AG 2282 DC	1 987 476 885
98AG 2853 AF	1 987 477 929
98AG 2853-AH	1 987 482 121

98BG 2A809 AA	1 987 477 521
98BG 2A809 AB	1 987 477 521
98BG 2A809 AD	1 987 477 521
98BG 2A809 BA	1 987 477 836
98BG 2A809 BC	1 987 477 836

98BG 2A809 BD	1 987 477 836
98BG 2A809 DA	1 987 477 374
98BG 2A809 DD	1 987 477 374
98BG 2A809 DG	1 987 477 374
98BG 2C285 BC	0 265 220 495

98BG 2C285 DB	0 265 220 495
98BG 2C285 DC	0 265 220 495
98BG 2M110 AF	0 265 216 701
98BG 2M110 BC	0 265 216 701
98BG 2M110 BD	0 265 216 701

98GG 2M110 BC	0 265 216 701
98KB 2282 AA	1 987 476 176
98KB 2282 AB	1 987 476 176
98KB 2282-AC	1 987 476 840
98KB 2282 AE	1 987 476 840

98VB 2B507 AA	F 026 003 354
98VB 2B507 AA	0 204 123 577
98VB 2B507 BA	0 204 123 355
98VB 2005 BA	0 204 125 531
988F1 2A699 BB	0 261 231 124

988F1 2A699 BC	0 261 231 124
99VB 2C219 AA	0 265 216 625
99VB 2C219 BA	0 265 216 625
99VB 2C219 BA	0 265 220 468
99VB 2C219 BB	0 265 220 468

99VB 2C219 BC	0 265 220 468
99VB 2C219 DA	0 265 216 625
99VB 2C219 DB	0 265 216 625
99VB 2C219 DC	0 265 216 625

GAZ

163033	0 265 215 525
--------	----------------------

HONDA

01464 SAA G01	1 987 481 075
01464-S10-010	1 987 476 973
01464 S2G 000	1 987 476 890

01464 S2H 000	1 987 476 981
01464-S30-000	1 987 476 847
01464 S6D 000	1 987 476 987
01464 S9A 000	1 987 481 044
01465 SAA G01	1 987 481 076

01465 S10 01	1 987 476 206
01465 S2G 000	1 987 476 889
01465-S30-000	1 987 476 848
01465 S6D 000	1 987 476 986
01465 S9A 000	1 987 481 027

01466 SAA 000	1 987 476 583
01466-SA5-020	1 987 476 525
01466 SE0 0209	1 987 476 536
01466-S04-900	1 987 481 038
01466-S07-000	1 987 476 888

01466 S2H 000	1 987 476 980
01466 S5A J02	1 987 476 988
01466 S5A J03	1 987 476 988
01466 S5A J04	1 987 476 988
01466 S5A 000	1 987 476 107

01466 S50 000	1 987 476 888
01468 SAA 000	1 987 476 210
01468 S5A J02	1 987 476 989
01468 S5A J03	1 987 476 989
01469 SAP 000	F 01G 09B 1RA

01469 SDC A00	F 01G 09B 1WD
01469 SDC A00	F 01G 061 08V
01469 SDC E00	F 01G 09B 1WE
01469 SDC E00	F 01G 061 0J1
01469 SDC E00	F 01G 061 08W

01469 SDD A00	F 01G 09B 1WF
01469 SDD A10	F 01G 061 0J3
01469 SDD A10	F 01G 061 08X
01469 SDD E00	F 01G 09B 1WG
01469 SDD E10	F 01G 061 0J5

01469 SDD E10	F 01G 061 08Y
01469 SEA G01	F 01G 09B 1WC
01469 SEA G01	F 01G 061 087
01469 SEA G02	F 01G 061 0HX
01469 SEA G02	F 01G 061 0K5

01469 SEA G11	F 01G 09B 1WL
01469 SEA G11	F 01G 061 0JB
01469 SEA G11	F 01G 061 08E
01469 SEA G51	F 01G 09B 1WM
01469 SEA G52	F 01G 061 0JD

01469 SEA G52	F 01G 061 08G
01469 SEA J01	F 01G 09B 1WJ
01469 SEA J01	F 01G 061 0J7
01469 SEA J01	F 01G 061 08A
01469 SEA J51	F 01G 09B 1WK

01469 SEA J52	F 01G 061 0J9
01469 SEA J52	F 01G 061 08C
01469 SEA J71	F 01G 061 0H4
01469 SEA J71	F 01G 061 0JH
01469 SEA N00	F 01G 09B 1LU

01469 SEA N01	F 01G 09B 1LV
01469 SEA 000	F 01G 09B 1WB
01469 SEA 000	F 01G 061 0HV
01469 SEF E00	F 01G 061 01J
01469 SEF E50	F 01G 061 01K

01469 SEF E61	F 01G 061 0H5
01469 SEF E61	F 01G 061 0JM
01469 SEF G00	F 01G 061 0JP
01469 SEF G00	F 01G 061 01L
01469 SEF G50	F 01G 061 01M

01469 SEF G51	F 01G 061 0HT
01469 SEF G51	F 01G 061 08T
01469 SEF G61	F 01G 061 0H6
01469 SEF G61	F 01G 061 0JS
01469 SFA 950	F 01G 061 0L1

01469 SFA 950	F 01G 061 01N
01469 SFA 950	F 01G 061 09N
01469 SFY J00	F 01G 09B 1WN
01469 SFY J00	F 01G 061 0JF
01469 SFY J30	F 01G 09B 1WP

01469 SWW E00	0 204 125 888
01469-SWW-E01	0 204 702 755
01469 SWW G00	0 204 125 887
01469-SWW-G01	0 204 702 754
01469 SWY E00	0 204 125 890

01469-SWY-E10	0 204 702 757
01469 SWY G00	0 204 125 889
01469-SWY-G10	0 204 702 756
01469 S2K 800	F 01G 09B 1RB
01469 S2K 801	F 01G 09B 1RB

01469 S2K 801	F 01G 061 0L3
01469 S3N 010	F 01G 09B 1LR
01469 S3R 000	F 01G 09B 1LS
38320-SG9-000	0 332 512 009
39960 SMR E010 M1	0 265 005 787

43030-SP8-000	0 986 475 808
43031-SP8-000	0 986 475 809
43300 SAA G01	0 986 475 961
43300-SA3-681	0 986 475 706
43300-SB2-003	0 986 475 708

43300-SE0-013	0 986 475 754
43300-SF4-003	0 986 475 708
43300 SH3 J01	0 986 475 710
43300-SR3-003	0 986 475 710
43300 ST3 E01	0 986 475 855

43300-S10-003	0 986 475 942
43300-671-632	0 986 475 531
43300-671-633	0 986 475 531
43300-692-013	0 986 475 806
43301-SA3-681	0 986 475 705

43301-SB2-003	0 986 475 707
43301 SH3 J01	0 986 475 709
43301 SM4 A01	0 986 475 709
43301-SR3-003	0 986 475 709
43301 ST3 E01	0 986 475 854

43301-S10-003	0 986 475 943
43301-692-003	0 986 475 805
46100 SAAG51	0 986 480 881
46100-SA5-023	0 986 480 617
46100-SA5-033	0 986 480 617

46100-SA5-603	0 986 480 617
46100-SA5-621	0 986 480 617
46100-SA5-622	0 986 480 617
46100-SA5-623	0 986 480 617
46100SFA9511M1	F 01G 09C 12N

46100SFA9520M101	F 01G 09C 12P
46100SFA9521M1	F 01G 09C 12R
46100 SH3 A02	0 986 480 702
46100 SH3 A04	0 986 480 702
46100 SH3 A06	0 986 480 702

46100 SK7 J01	0 986 480 700
46100 SK7 J03	0 986 480 700
46100 SM4 A01	0 986 480 701
46100 SM4 A02	0 986 480 701
46100 SM4 A03	0 986 480 701

46100 SM4 A04	0 986 480 701
46100 SN7 G00	0 986 480 957
46100 SN7 G01	0 986 480 957
46100-SR3-003	0 986 480 702
46100-SR3-013	0 986 480 702

◀ HONDA

46400SAP0030CB	F 01G 09B 1R9
46400 SD4 A31	F 01G 09B 0V4
46400 SD4 931	F 01G 09B 0V3
46400 SS0 A51	F 01G 09B 18P
46400 SZ3 A02	F 01G 09B 1LF
<hr/>	
46400 SZ3 A05	F 01G 09B 1LJ
46400 SZ3 A050 M1	F 01G 09B 1LH
46400SZ3A052M1	F 01G 09B 1LJ
46400 SZ3 A11	F 01G 09B 1LM
46400 SZ3 J03	F 01G 09B 1LN
<hr/>	
46400 SZ3 013	F 01G 09B 1LE
46400 SZ3 043	F 01G 09B 1LG
46400 SZ5 A52	F 01G 09B 1LC
46400 SZ5 952	F 01G 09B 1LD
46400 S2X 003	F 01G 09B 1LP
<hr/>	
46400 S30 A52	F 01G 09B 1LL
46400 S30 952	F 01G 09B 1LK
46410-SA0-013	1 987 476 578
46410-SA0-024	1 987 476 578
46410-SA0-025	1 987 476 578
<hr/>	
46410-SA0-033	1 987 476 578
46410-SB2-003	1 987 476 537
46410-SB2-004	1 987 476 537
46410-SB2-005	1 987 476 537
46410-SB2-013	1 987 476 537
<hr/>	
46410-SB2-015	1 987 476 537
46410-SB2-023	1 987 476 537
46410-SB2-024	1 987 476 537
46410-SB2-025	1 987 476 537
46410-SB2-044	1 987 476 537
<hr/>	
46410-SG9-010	1 987 476 592
46410-SH3-033	1 987 476 322
46410-SH3-043	1 987 476 322
46410-SH3-044	1 987 476 322
46410 SK3 E01	1 987 476 526
<hr/>	
46410-SM4-013	1 987 476 754
46410-SN7-003	1 987 476 754
46410-SR3-003	1 987 476 322
46410 S1A E01	1 987 476 186
46411-SG9-010	1 987 476 589
<hr/>	
46411-SH3-033	1 987 476 665
46411-SH3-034	1 987 476 665
46411-SH3-043	1 987 476 665
46411-SM1-003	1 987 476 755
46411-SM4-013	1 987 476 755
<hr/>	
46411-SN7-003	1 987 476 755
46411 ST3 E02	1 987 476 734
46411 S1A E01	1 987 476 187
46430-SB3-003	1 987 476 538
46430-SB3-004	1 987 476 538
<hr/>	
46430-SB3-024	1 987 476 538
46430-SB6-003	1 987 476 538
46430-SD4-013	1 987 476 591
46430-SE0-013	1 987 476 536
46430-SE0-014	1 987 476 536

46430 SE5 A01	1 987 476 536
46430-SH3-933	1 987 476 070
46430-SH3-937	1 987 476 070
46430 SK3 E01	1 987 476 527
46430-SK7-931	1 987 476 070
<hr/>	
46430-SN7-003	1 987 476 109
46430-SN7-003	1 987 476 929
46430-SR3-938	1 987 481 038
46430 ST3 E01	1 987 476 070
46430 ST3 E11	1 987 476 071
<hr/>	
46430 ST3 E51	1 987 476 070
46430 S1A E01	1 987 481 142
46430-5D4-013	1 987 476 590
46431-SN7-003	1 987 476 928
46431-SS0-003	1 987 481 107
<hr/>	
46431 S1A E01	1 987 476 891
46440 S3X 003	F 01G 09B 1LT
46920 SM4 A03	0 986 486 044
46920-671-023	0 986 486 007
46920-671-651	0 986 486 007
<hr/>	
46920-692-003	0 986 486 007
46930-SN7-010	0 986 486 524
46930-SR3-013	0 986 486 555
46930-671-013	0 986 486 522
47510 SK3 E01	1 987 477 736
<hr/>	
47510 SK3 E12	1 987 477 788
47510-SM4-955	1 987 482 175
47510-SM5-952	1 987 482 175
47510-SN7-952	1 987 477 673
47510 SR3 N01	1 987 477 447
<hr/>	
47510-SR3-931	1 987 477 737
47510 SR 4A01	1 987 482 084
47510 S10 A03	1 987 482 086
47560-SH3-013	1 987 477 601
47560 SK3 E01	1 987 477 738
<hr/>	
47560 SK3 E12	1 987 477 789
47560 SM4 A02	1 987 477 739
47560 SM4 A04	1 987 477 739
47560-SN7-953	1 987 477 602
47560 SR3 N01	1 987 477 448
<hr/>	
47560-SR3-931	1 987 477 740
47560 SR4 A03	1 987 482 085
47560 S10 A03	1 987 482 087
57105 S6A E51	F 01G 09D 067
57110 SAP 003	F 01G 09D 06L
<hr/>	
57110 SAR 003	F 01G 09D 06S
57110-SN7-003	0 265 216 049
57110 ST3 E03	0 265 216 047
57110 ST3 E51	0 265 216 494
57110 SZ3 J62	F 01G 09D 0AF
<hr/>	
57110 SZ3 J65	F 01G 09D 0AN
57110-SZ3-610	0 265 225 024
57110 S1A E01	0 265 216 650
57110 S2K 953	F 01G 09D 05J
57110 S2L 953	F 01G 09D 05K

57110 S2R 952	F 01G 09D 05L
57110 S3A J01	F 01G 09D 0B7
57110 S3A 013	F 01G 09D 036
57110 S3B 003	F 01G 09D 037
57110 S5A A60	F 01G 09D 08G
<hr/>	
57110 S5A D60	F 01G 09D 09R
57110 S5A G60	F 01G 09D 08H
57110 S5L G60	F 01G 09D 09S
57110 S5L K60	F 01G 09D 09H
57110 S5T A50	F 01G 09D 09D
<hr/>	
57110 S5T E50	F 01G 09D 09A
57110 S6A E60	F 01G 09D 08J
57110 S6D G60	F 01G 09D 099
57110 S6E E50	F 01G 09D 09V
57110 S74 E50	0 265 216 520
<hr/>	
57110 S74 E51	0 265 216 685
57110 S9R 013	F 01G 09D 03A
57110 S9R 023	F 01G 09D 03B
57110 S9T 013	F 01G 09D 03C
57110 S9T 023	F 01G 09D 03D
<hr/>	
57111 SMG A00	0 265 235 080
57111 SMG A10	0 265 235 076
57111 SMG A50	0 265 231 779
57111 SMG A52	0 265 231 777
57111 SMG E00	0 265 235 082
<hr/>	
57111 SMG E02	0 265 235 082
57111 SMG E03	0 265 235 082
57111 SMG E10	0 265 235 078
57111 SMG E12	0 265 235 078
57111 SMG E13	0 265 235 078
<hr/>	
57111 SMG E50	0 265 231 777
57111 SMG E52	0 265 231 779
57111 SMJ E00	0 265 235 074
57111 SMJ E02	0 265 235 074
57111 SMJ E03	0 265 235 074
<hr/>	
57111 SMR E00	0 265 235 278
57111 SMS E00	0 265 235 280
57111 SMT E00	0 265 235 282
57111 SWW E00	0 265 235 305
57111 SWW E90	0 265 235 303
<hr/>	
57111 SWW G00	0 265 235 309
57111 SWW G90	0 265 235 307
57111 SWY G00	0 265 235 313
57111 SWY G90	0 265 235 311
57450 S74 E00	0 265 006 259
<hr/>	
57455 S74 E00	0 265 006 258
57470 S74 E00	0 265 006 268
57475 S74 E00	0 265 006 267
<hr/>	
HYUNDAI	
39250 22003	0 261 231 091
58320 4A020	0 986 475 959
58320 4A020	0 986 475 957

58330 02000	0 986 475 928
58330 21300	0 986 475 663
58330 22000	0 986 475 846
58330 24002	0 986 475 839
58330 24003	0 986 475 839
<hr/>	
58330 25000	0 986 475 855
58330 25200	0 986 475 928
58330 25300	0 986 475 928
58330 28001	0 986 475 848
58330 3A000	0 986 475 944
<hr/>	
58380 02000	0 986 475 929
58380 22000	0 986 475 847
58380 24002	0 986 475 851
58380 24003	0 986 475 851
58380 25000	0 986 475 854
<hr/>	
58380 25200	0 986 475 929
58380 25300	0 986 475 929
58380 28001	0 986 475 849
58380 3A000	0 986 475 945
584204A020	0 986 475 960
<hr/>	
58420 44020	0 986 475 958
58510 02000	0 986 480 991
58510 29010	0 986 480 938
58731 02011	1 987 476 848
58731 1C000	1 987 481 169
<hr/>	
58731 1C050	1 987 481 169
58731 17000	1 987 476 188
58731 2D000	1 987 481 155
58731 21020	1 987 476 539
58731 21030	1 987 476 539
<hr/>	
58731 21350	1 987 476 539
58731 22000	1 987 476 900
58731 22100	1 987 476 900
58731 24010	1 987 476 343
58731 25000	1 987 476 236
<hr/>	
58731 28000	1 987 476 539
58731 29010	1 987 476 898
58731 29020	1 987 476 898
58732 02011	1 987 476 892
58732 17000	1 987 476 189
<hr/>	
58732 2D000	1 987 481 156
58732 22000	1 987 476 899
58732 22100	1 987 476 899
58732 29010	1 987 476 897
58732 29020	1 987 476 897
<hr/>	
58737 02000	1 987 476 894
58737 02001	1 987 476 894
58737 1C000	1 987 476 850
58737 17000	1 987 476 190
58737 2D300	1 987 476 076
<hr/>	
58737 22000	1 987 476 901
58737 22001	1 987 476 901
58737 24000	1 987 476 502
58737 28000	1 987 476 965
58737 29310	1 987 476 896



58737 29320	1 987 476 896
58738 02000	1 987 476 893
58738 02001	1 987 476 893
58738 1C000	1 987 476 019
58747 29310	1 987 476 895

58747 29320	1 987 476 895
58770 25200	1 987 477 055
58811 26000	1 987 476 370
58811 26020	1 987 476 371
58811 43001	1 987 481 039

58812 26050	1 987 481 050
58812 26150	1 987 476 367
58812 26250	1 987 476 367
58814 43002	1 987 481 009
58910 1CA00	0 265 231 358

58910 1CA10	0 265 231 449
58910 1C310	0 265 231 358
58920 3C300	0 265 220 653
58920 3C500	0 265 220 655
59470 43050	0 265 200 069

59760 02010	1 987 477 611
59760 02020	1 987 477 611
59760 1C000	1 987 482 072
59760 1C300	1 987 482 070
59760 1C800	1 987 482 223

59760 17010	1 987 482 074
59760 17510	1 987 482 209
59760 2D310	1 987 482 166
59760 22000	1 987 482 164
59760 22100	1 987 477 612

59760 22110	1 987 477 612
59760 25000	1 987 477 614
59760 25200	1 987 477 066
59760 27001	1 987 477 741
59760 27300	1 987 477 842

59760 27301	1 987 477 842
59760 29001	1 987 482 168
59770 02010	1 987 477 613
59770 02020	1 987 477 613
59770 1C000	1 987 482 073

59770 1C300	1 987 482 071
59770 1C800	1 987 482 224
59770 17010	1 987 482 075
59770 17510	1 987 482 210
59770 2D310	1 987 482 167

59770 22000	1 987 482 165
59770 22100	1 987 477 614
59770 22110	1 987 477 614
59770 25000	1 987 477 614
59770 27001	1 987 477 742

59770 27300	1 987 477 743
59770 27301	1 987 477 743
59770 29001	1 987 482 169
59912 26150	1 987 482 076
59913 26150	1 987 482 077

95540 43300	0 265 103 072
95640 M3200	0 265 005 142

ISUZU

1-15779-238-0	9 421 613 391
5475001730	F 01G 09B 2A7
5-47500-247-0	F 01G 09C 1NG

5 47500 259 1	F 01G 09C 1GL
5 47500 288 0	F 01G 09C 1GM
8941632840	F 01G 161 1P3
8 94173 228 3	F 01G 09B 0WC
8-94222-685-1	1 987 476 549

8-94230-541-2	0 986 475 807
8-94230-541-3	0 986 475 807
8-94230-541-5	0 986 475 807
8-94316-795-1	1 987 476 550
894327 390 0	F 01G 09C 1AM

894341 713 2	F 01G 09B 0ST
894341 714 2	F 01G 09B 0SU
8 94374 855 6	F 01G 09D 01G
894375 407 1	F 01G 09B 18H
894401 552 3	F 01G 09B 0WB

8-94403-322-3	1 987 476 911
894434 069 3	F 01G 09B 0WD
894437 589 2	F 01G 09C 1AL
894437 827 1	F 01G 09C 1A8
894457 694 1	F 01G 09C 1GR

894463 278 3	F 01G 09B 0PH
897021 942 1	F 01G 09B 112
897021 943 1	F 01G 09B 111
8970406341	F 01G 09B 15X
897070 628 0	F 01G 09C 1AP

897087 173 1	F 01G 09B 15Z
897087 174 1	F 01G 09B 160
897091 706 3	F 01G 09B 110
897101 309 0	F 01G 09B 23K
897102 210 0	F 01G 09D 027

897110 058 2	F 01G 09D 02A
897114 360 0	F 01G 09E 00W
897137 619 0	F 01G 09C 1AJ
897162 192 1	F 01G 09D 02J
897162 798 0	F 01G 09B 1JH

897162 799 0	F 01G 09B 23D
897162 799 3	F 01G 061 0R5
897162 800 1	F 01G 061 0PY
897167 848 1	F 01G 09B 1JG
897167 849 0	F 01G 09B 1JD

897167 850 1	F 01G 09B 24H
897167 851 0	F 01G 09B 1BR
897167 852 0	F 01G 09B 1BT
897167 852 1	F 01G 09B 1BX
897167 853 0	F 01G 09B 1BS

897173 025 0	F 01G 09D 02N
897175 052 0	F 01G 09D 02S
897177 971 1	F 01G 09B 15Y
897177 973 4	F 01G 09B 23B
897177 973 5	F 01G 09B 23C

897178 009 0	F 01G 09C 1BC
897178 011 0	F 01G 09C 1B6
897178 913 0	F 01G 09C 1B7
897180 555 0	F 01G 09B 117
897180 689 0	F 01G 09B 1JJ

897180 689 1	F 01G 061 0PW
897181 861 0	F 01G 09C 1AN
897201 297 0	F 01G 09B 116
897209 212 0	F 01G 060 1AM
897219 299 0	F 01G 09C 0XP

897224 363 0	F 01G 09C 0XS
897224 365 0	F 01G 09C 0XR
897224 368 0	F 01G 19C 02K
897224 369 0	F 01G 19C 02F
897224 370 0	F 01G 19C 02L

897224 371 0	F 01G 19C 02E
897224 372 0	F 01G 19C 02D
897224 373 0	F 01G 19C 02J
897224 374 0	F 01G 19C 02C
897224 375 0	F 01G 062 0AR

897229 185 0	F 01G 09B 1BU
897230 009 0	F 01G 09D 038
897245 095 0	F 01G 09B 1NA
897245 095 1	F 01G 061 0PZ
897254 770 0	F 01G 19C 02G

897254 771 0	F 01G 19C 02H
897255 852 0	F 01G 09C 1B8
897287 380 0	F 01G 09B 11A
897302 964 0	F 01G 09C 1BA
8-97307-390-0	0 204 322 325

897310 048 0	F 01G 09C 1AS
897315 164 0	F 01G 19C 02M
897315 165 0	F 01G 19C 02N
897315 166 0	F 01G 19C 02P
897315 167 0	F 01G 19C 02R

897318 440 1	F 01G 09B 118
897353 310 0	F 01G 09B 1BV
8973533101	F 01G 09B 25B
898006 379 1	F 01G 062 080
898031 414 0	F 01G 060 0PX

898032 599 0	F 01G 19C 02S
898032 600 0	F 01G 19C 02T
898032 602 0	F 01G 19C 02U
898032 603 0	F 01G 19C 02V
898032 617 0	F 01G 29L 01M

898032 618 0	F 01G 29L 01N
9 4316 795	1 987 476 550

IVECO

R2717085	0 204 162 053
00000098432258	0 332 512 009
1367644	0 261 231 046

2991741	0 204 125 735
2991743	F 026 003 140
2991743	0 204 122 140
2991745	0 204 123 537
2991751	0 204 123 413

300662048	0 265 216 845
32258490	0 204 122 186
42100525	0 265 050 010
42105225	0 265 050 010
4219866	0 204 162 065

4237415	F 026 003 160
42530422	0 204 125 478
42530541	0 204 125 266
42530542	F 026 003 140
42530542	0 204 122 140

42533295	1 460 491 300
42556837	0 204 123 732
42556838	0 204 123 733
42556841	0 204 125 899
42558399	0 204 031 050

4276036	F 026 002 253
4276036	0 204 116 253
4292543	0 204 162 077
4296247	0 204 116 255
4304504	0 204 116 256

4657483	0 204 162 067
4660357	0 204 125 268
4696673	0 204 162 064
4700150	0 204 162 077
4721716	0 204 123 308

4723798	F 026 003 160
4744164	F 026 002 259
4744164	0 204 116 259
4754206	F 026 003 157
4754206	0 204 122 157

4758288	0 204 122 151
4760570	0 204 163 041
4762814	F 026 003 157
4762814	0 204 122 157
4764049	0 204 122 158

4765078	F 026 003 160
4765079	F 026 003 176
4765079	0 204 122 176
4770993	F 026 005 568
4774874	0 204 162 071

4783798	F 026 003 160
4787681	0 204 131 235
4791100	0 204 125 318
4792417	0 204 131 239
4792418	0 204 131 236

◀ IVECO

4797460	0 204 125 333
4797844	F 026 003 176
4797844	0 204 021 200
4797844	0 204 122 176
4797845	F 026 005 075

4797845	0 204 162 075
4797846	0 204 123 308
4800160	F 026 005 075
4803892	0 204 163 059
4804129	0 204 122 183

4804131	F 026 003 980
4804131	0 204 122 180
4804132	F 026 003 179
4804132	0 204 122 179
4813096	0 204 125 305

4813097	0 204 125 290
4817854	0 204 122 187
4817855	0 204 122 188
4819229	0 204 125 269
4837192	0 204 116 262

4837195	0 204 116 264
4844300	0 204 125 459
4844301	0 204 125 391
4844302	0 204 125 393
4848576	F 026 005 568

4848577	0 204 163 069
4848578	0 204 163 070
4853408	F 026 005 084
4854828	F 026 005 564
4859829	0 204 131 237

4861852	0 204 131 238
4977844	F 026 003 176
4977844	0 204 122 176
5000302884	0 204 125 459
500319571	0 204 131 221

500319571	0 204 131 380
500321346	0 265 216 438
500329931	0 204 031 119
500329931	0 204 131 378
500331028	0 265 219 427

500342090	0 265 004 025
500343006	0 204 024 694
500351154	0 265 220 501
500351155	0 265 219 427
500359653	0 204 021 934

500371198	0 265 219 442
500374416	0 204 021 854
503135480	0 204 162 027
504007426	0 265 004 025
504034920	0 265 216 845

504042984	0 204 021 854
504042985	0 204 021 934
504064538	0 204 024 694
504065620	0 265 234 131
504075550	0 265 234 133

504075552	0 265 231 451
504075554	0 265 231 453
504075556	0 265 231 455
504089710	0 204 021 854
504089711	0 204 021 934

504107853	0 265 005 489
504107856	0 265 005 241
504182308	0 265 231 892
504182310	0 265 231 896
504182312	0 265 233 360

504182315	0 265 233 028
504182317	0 265 234 526
504182319	0 265 234 528
504182323	0 265 231 894
504182325	0 265 233 026

5150299	0 204 162 108
5177914	0 204 163 102
5895518	0 265 204 004
5895519	0 265 204 003
5895520	0 265 204 006

5895521	0 265 204 008
5895522	0 265 204 010
5895523	0 265 204 014
5895524	0 265 204 016
5895526	0 265 210 002

5895525	0 265 208 034
5896073	0 265 216 425
5896075	0 265 216 408
5896076	0 265 216 404
61590154	0 204 162 066

7168821	0 265 050 002
76007423	F 026 003 157
76007423	0 204 122 157
76011418	0 204 122 158
7613939	0 265 201 024

7630317	0 265 001 215
76691230	0 261 231 007
7710140	0 265 201 054
7712078	0 265 001 338
7716537	0 265 204 003

7718934	0 265 001 337
7718935	0 265 001 336
7765599	0 261 231 102
7766248	0 265 006 140
7766249	0 265 006 139

8121576	0 986 475 826
8193797	0 204 116 145
8193798	0 204 116 146
82434700	0 265 005 030
8560385	0 204 125 276

8560386	0 204 125 270
8791260	0 204 125 304
8791823	0 204 125 289
8791824	0 204 125 290
8792360	0 204 125 304

8793375	0 204 125 307
8795065	0 204 125 305
8795099	0 204 125 718
8796219	0 204 125 322
8796377	0 204 125 333

91F1016	0 265 216 845
953422	F 026 003 157
953422	0 204 122 157
97260827	0 265 216 986
98417489	0 204 116 266

98420511	0 204 131 202
98431590	0 265 201 045
98432121	0 265 105 020
98432255	0 265 050 012
98432258	0 332 512 009

98434065	0 204 125 430
98447242	0 204 116 268
98453414	0 265 201 066
98453875	0 204 163 075
99434589	1 987 482 148

99436561	0 204 125 459
99456103	0 204 162 086
99459365	0 204 031 056
99460512	0 204 125 558
99463013	0 265 201 077

99463713	0 204 125 519
99464332	0 204 131 217
99483920	0 204 125 520
99483923	0 204 125 548
9989016	0 204 125 299

9989017	F 026 003 149
9989017	0 204 122 149

JEEP

52008674	1 987 481 083
52008674AC	1 987 481 083

KIA

KB092 43810	1 987 476 541
KK150 43810	1 987 476 541
KK151 43980	1 987 476 970

OK01C 18921	0 261 231 046
OK011 43810B	1 987 476 984
OK011 43830B	1 987 476 983
OK011 44150D	1 987 482 225
OK011 44150G	1 987 482 225

OK2A2 44410E	1 987 482 100
OK2A2 44410F	1 987 482 100
OK201 43810C	1 987 476 992
OK30A 43810A	1 987 476 177
OK30A 44420H	1 987 482 099

OK56A 43980A	1 987 481 069
OK56A 43990A	1 987 481 068
OK9YA 43780	0 265 213 015
OK95A 437AZA	0 265 215 413
OK95A 43701	0 265 006 352

OK95A 43701A	0 265 006 352
OK95A 43711A	0 265 006 353
OK95A 43731	0 265 006 351
OK95A 43731A	0 265 006 351
OK95B 437T0	0 265 217 408

OK95A 37AZA	0 265 215 413
1K994 66780	0 265 108 017
1K998 667B0	0 265 108 017
58330 FD100	0 986 475 946
58330 1G000	0 986 475 946

58380 25000	0 986 475 854
59760 07010	1 987 482 098
59770 07010	1 987 482 097
59770 07310	1 987 482 097
59770 07310	1 987 482 098

MAZDA

BA01-43-400B	0 986 480 707
BB1P43800A	F 01G 09B 0YC
BC1D-26-610	0 986 475 866

BC1D-43-810	1 987 476 964
BC5F43800A	F 01G 09B 10R
BD6C43800	F 01G 09B 1CF
BF67-43-400A	0 986 480 709
BF8143800C	F 01G 09B 0PE

BG1R43800B	F 01G 09B 11M
BG1S43800B	F 01G 09B 10S
BG3K43800A	F 01G 09B 15W
BG3443800	F 01G 09B 0NE
BG6243800	F 01G 09B 0NC

BH6443800	F 01G 09B 0PD
BJOG43950	F 01G 09B 10C
BJ3D43800	F 01G 09B 1BL
BJ4T43800	F 01G 09B 1CC
BK1T-43-980	1 987 476 114

BL4G43800	F 01G 09B 1CV
BL5B43800	F 01G 09B 23T
BL8M43800	F 01G 09B 1BD
BP4K-44-150B	1 987 482 059
BP4K-44-150C	1 987 482 059

BP4K-44-410E	1 987 482 057
BP4K-44-410F	1 987 482 057
BP4K-44-410L	1 987 482 057
BP4K-44-410M	1 987 482 057
BP4K-44-420E	1 987 482 058

BP4K-44-420K	1 987 482 058
BR7043800A	F 01G 09B 0Y4
BR7243800A	F 01G 09B 10A
B001-26-610	0 986 475 533
B001-26-610A	0 986 475 533

B001-44-150	1 987 477 104
B001-44-150D	1 987 477 104
B001-44-150E	1 987 477 104
B01C4340Z	F 01G 09C 1BE
B01D43800B	F 01G 09B 10P

B01G4340Z	F 01G 09C 1BF
B01J43800B	F 01G 09B 11K
B02B43800B	F 01G 09B 1BH
B092-26-610	0 986 475 660
B092-43-810A	1 987 476 541

B092-43-980	1 987 476 540
B092-44-410	1 987 477 105
B092-44-410A	1 987 477 105
B092-44-410B	1 987 477 105
B092-44-410D	1 987 477 105

B092-44-410E	1 987 477 105
B092-44-420A	1 987 477 109
B092-44-420B	1 987 477 109
B092-44-420D	1 987 477 109
B09543800	F 01G 09B 0ND

B13R4340ZB	F 01G 09C 1BH
B13R43800B	F 01G 09B 1CE
B21J43800A	F 01G 09B 11L
B21K43800A	F 01G 09B 15V
B21V43800A	F 01G 09B 15U

B216-26-610	0 986 475 660
B216-26-610B	0 986 475 660
B22S43800A	F 01G 09B 15T
B25D-43-980A	1 987 476 110
B25D-44-410B	1 987 482 153

B25D-44-410C	1 987 482 153
B25D-44-420B	1 987 482 154
B25D-44-420C	1 987 482 154
B26C43800A	F 01G 09B 1CA
B26J43800A	F 01G 09B 1BM

B30D43800	F 01G 09B 1BC
B30F43800A	F 01G 09B 1T2
B30H43800	F 01G 09B 1BE
B30R43800A	F 01G 09B 1BF
B455-43-810A	1 987 476 732

B455-43-980	1 987 476 966
B455-43-980A	1 987 476 966
B455-43-980B	1 987 476 966
B455-44-410C	1 987 477 492
B455-44-410D	1 987 477 492

B455-44-410E	1 987 477 492
B455-44-420C	1 987 477 493
B455-44-420D	1 987 477 493
B455-44-420E	1 987 477 493
B461-43-980A	1 987 476 112

B461-43-980B	1 987 476 112
B467-44-410C	1 987 477 494
B467-44-410D	1 987 477 494
B467-44-410E	1 987 477 494
B467-44-420C	1 987 477 495

B467-44-420D	1 987 477 495
B467-44-420E	1 987 477 495
B53143800B	F 01G 09B 0TU
CA094340Z	F 01G 09C 1BJ
CA0943800A	F 01G 09B 1B1

CA104340Z	F 01G 09C 1BK
CB0143800A	F 01G 09B 1J4
CB0543800A	F 01G 09B 1M1
CB0743800A	F 01G 09B 1J5
CB1543800A	F 01G 09B 1M2

CB1543800B	F 01G 09B 1M4
CB8943800	F 01G 09B 1J8
CB9343800	F 01G 09B 1J7
CB9843800	F 01G 09B 1M3
CC0143800	F 01G 09B 1J9

C10443800B	F 01G 09B 1J6
C10443800C	F 01G 09B 1JA
C15343800	F 01G 09B 1JB
C236-44-410D	1 987 482 052
C236-44-410E	1 987 482 052

C236-44-420D	1 987 482 053
C236-44-420E	1 987 482 053
DB0243800B	F 01G 09B 0XA
DC2043800	F 01G 09B 24E
DC2243800	F 01G 09B 1B4

DC2743800C	F 01G 09B 12E
DC4943800	F 01G 09B 1P4
DC9243800	F 01G 09B 1P5
DDY2-26-710	0 986 475 926
D001-26-610A	0 986 475 755

D001-26-610B	0 986 475 840
D001-43-980A	1 987 476 902
D03143800	F 01G 09B 0NF
D061-43-810	1 987 476 344
D061-43-810C	1 987 476 344

D061-43-810E	1 987 476 344
D061-43-980	1 987 476 902
D061-43-980A	1 987 476 902
D061-43-980B	1 987 476 902
D062-43-810B	1 987 481 116

D06343800C	F 01G 09B 0YE
D10143800A	F 01G 09B 0YB
D10143800A	F 01G 09B 0YF
D10243800	F 01G 09B 0YG
D20143800	F 01G 09B 0YS

D20543800	F 01G 09B 0YT
D27343800A	F 01G 09B 1P3
D27343800B	F 01G 09B 1P6
D350 04 4430D	1 987 477 906
D350-43-810B	1 987 476 078

D350-44-400C	1 987 477 732
EA0343800B	F 01G 09B 1B2
EA7643800	F 01G 09B 0Y5
EA7743800	F 01G 09B 10B
E0184340Z	F 01G 09C 1BL

E01843800B	F 01G 09B 1B3
E04143800	F 01G 09B 1B5
FA5543800	F 01G 09B 0MH
FB0143800C	F 01G 09B 0PF
FB0543800D	F 01G 09B 0SP

FC0643800A	F 01G 09B 0TS
FD04437A0D	F 01G 09D 01B
FD0443800B	F 01G 09B 0WA
FD31437A0B	F 01G 09D 021
FEY7437A0	F 01G 09D 0B1

F04443800D	F 01G 09B 0SN
F048437A0F	F 01G 09D 00L
F048437A0J	F 01G 09D 00R
F048437B0B	0 265 103 019
F06543800A	F 01G 09B 0TT

F1Y3 43 7A0	0 265 225 243
F1Y3 43 7A0B	0 265 225 243
F1Y3437A0C	F 01G 09D 0B0
F100437A0A	F 01G 09D 01M
F10043800A	F 01G 09B 0W9

F123437A0A	F 01G 09D 022
F13243800A	F 01G 09B 1BJ
F133437A0A	F 01G 09D 02V
F146437A0	F 01G 09D 03F
F153437A0C	F 01G 09D 0AW

F2Y5437A0	F 01G 063 00G
GA02-26-610	0 986 475 537
GA02-26-610A	0 986 475 537
GA02-26-710	0 986 475 536
GA02-26-710A	0 986 475 536

GA5R43800A	F 01G 09B 10D
GA5R-43-980	1 987 476 733
GA5R-43-980B	1 987 476 733
GA5R-44-150B	1 987 477 503
GA5R-44-150C	1 987 477 503

GA5R-44-410C	1 987 477 501
GA5R-44-420D	1 987 477 502
GA5T43800A	F 01G 09B 1B6
GA5V43800A	F 01G 09B 10W
GA6B43800	F 01G 09B 10X

GA6C43800A	F 01G 09B 1B7
GA7B-43-810	1 987 476 985
GA7N43800	F 01G 09B 10E
GA97-43-400A	0 986 480 714
GA9743800B	F 01G 09B 0S9

GB2L43800	F 01G 09B 10K
GB3E43800A	F 01G 09B 10L
GB3F43800A	F 01G 09B 11H
GB3J43800A	F 01G 09B 11G
GD7E-43-701	0 265 006 316

GD7E-43-721	0 265 006 319
GD7E 43 73XD	0 265 006 317
GD7E-43-731	0 265 006 317
GE4T43800	F 01G 09B 10F
GE4V43800A	F 01G 09B 10J

GE7C43800	F 01G 09B 10Y
GE7C-44-410B	1 987 477 916
GE7C-44-410D	1 987 477 916
GE7C-44-420B	1 987 477 917
GE7C-44-420D	1 987 477 917

GE7E43800A	F 01G 09B 10U
GE7T43800	F 01G 09B 10G
GE8K43800	F 01G 09B 10H
GF3K43800A	F 01G 09B 1BB
GJ21-26-610A	0 986 475 661

GJ21-26-610C	0 986 475 661
GJ21-44-150	1 987 477 503
GJ6A43800	F 01G 09B 221
GJ6A43950A	F 01G 09B 225
GJ6A43950B	F 01G 060 1AN

GJ6A-44-410A	1 987 482 054
GJ6A-44-410C	1 987 482 054
GJ6F43800	F 01G 09B 223
GJ6G43950A	F 01G 09B 226
GJ6G43950B	F 01G 060 1AR

GJ8F43800	F 01G 09B 224
GJ83-43-400B	0 986 480 717
GJ8343800B	F 01G 09B 23G
GJ9E43950	F 01G 09B 227
GJ9E43950A	F 01G 060 1AY

GJ9M43950	F 01G 09B 228
GJ9M43950A	F 01G 060 1AZ
GL0643800C	F 01G 09B 0T1
GOOD43800A	F 01G 09B 10M
GOOF43800B	F 01G 09B 10N

G00S43800	F 01G 09B 10Z
G011-41-920	0 986 486 515
G02K43800B	F 01G 09B 1CD
G030-26-610	0 986 475 892
G030-43-980	1 987 476 542

G030-43-980B	1 987 476 542
G030-44-410E	1 987 477 108
G030-44-410F	1 987 477 108
G030-44-420E	1 987 477 193
G030-44-420F	1 987 477 193

G031-43-810A	1 987 476 543
G031-43-810B	1 987 476 543
G032-26-610	0 986 475 892
G09A43800	F 01G 09B 1BG
G14H43800	F 01G 09B 10V

G14K43800	F 01G 09B 1BA
G15L43800	F 01G 09B 1M5
G16N43800	F 01G 09B 10T
G18K43800	F 01G 09B 1BP
G18P4340Z	F 01G 09C 1CY

G18P4343Z	F 01G 09C 1CT
G18P43800	F 01G 09B 1HN
G21343800B	F 01G 09B 0T0
G213-44-420F	1 987 477 747
G21943800B	F 01G 09B 0T2



◀ MAZDA

G22C43800	F 01G 09B 222
G23543800B	F 01G 09B 05R
G52043800	F 01G 09B 05S
HA7443800D	F 01G 09B 0MG
HB5243800	F 01G 09B 0PB

HE0143800B	F 01G 09B 05G
HE5743800A	F 01G 09B 05F
HG31437AOC	F 01G 09D 01A
HG3143800A	F 01G 09B 18F
HG82437A0B	F 01G 09D 020

H26643800B	F 01G 09B 0TL
H280437A0E	F 01G 09D 00S
H38143800B	F 01G 09B 1J1
H43043800	F 01G 09B 1HK
H43143800	F 01G 09B 1HY

H44943800	F 01G 09B 1HL
J00143800C	F 01G 09B 0V1
LA0143800A	F 01G 09B 0TM
LA1243800	F 01G 09B 0VO
LA8343800	F 01G 09B 18A

LA8343800	F 01G 09B 24K
LB8243800	F 01G 09B 1HH
LC1543800A	F 01G 09B 1C9
LC6443800	F 01G 09B 1X7
LC6643800	F 01G 09B 1X8

LD4743800	F 01G 09B 1XB
LD4743800A	F 01G 09B 1XC
LD6243800	F 01G 09B 1XE
LD7143800	F 01G 09B 1XF
LD8043800A	F 01G 09B 1XD

LE4443800	F 01G 09B 1HR
LE4443800A	F 01G 061 04F
LE5943800A	F 01G 061 04H
LE6443800A	F 01G 061 04G
LE6743800A	F 01G 061 04J

L00143800	F 01G 09B 0TN
L00343800A	F 01G 09B 23P
L02243800	F 01G 09B 1HJ
L02743800	F 01G 09B 1C7
L08143800A	F 01G 09B 1XA

L12043800A	F 01G 09B 1HX
NA0143800	F 01G 09B 0Y6
NA23437A0D	F 01G 09D 015
NA2343800	F 01G 09B 0YA
NA7543800	F 01G 09B 0Y7

NA8043800	F 01G 09B 0YD
NB86437A0B	F 01G 09D 02L
NC10-44-410A	1 987 482 055
NC10-44-410B	1 987 482 055
NC10-44-420A	1 987 482 056

NC10-44-420B	1 987 482 056
N007437A0A	F 01G 09D 01F
N036437A0B	F 01G 09D 023
N06643800A	F 01G 09B 1BN
N06743800A	F 01G 09B 0Y8

N068437A0	F 01G 09D 03E
N06943800	F 01G 09B 0Y9
N11543800	F 01G 061 06M
SG4143800	F 01G 09B 1B9
SG4243800A	F 01G 09B 1BK

SH54437A0	F 01G 09D 033
S08343800A	F 01G 09B 0SA
S09V437A0A	F 01G 09D 026
S09143800A	F 01G 09B 0PA
S11943800	F 01G 09B 0NB

S24A43800A	F 01G 09B 1B8
S24R43800A	F 01G 09B 0SE
S25E437A0A	F 01G 09D 02P
S31F43800	F 01G 09B 1CB
S38J437A0	F 01G 09D 034

S41D437A0A	F 01G 09D 05S
S41J437A0	F 01G 09D 05T
S46D43800A	F 01G 09B 1C8
S47P43800	F 01G 09B 1WA
S47S43800	F 01G 09B 1X9

S48C43800	F 01G 09B 1TU
S48D43800	F 01G 09B 1WZ
S49K43800	F 01G 09B 1HM
S49L43800	F 01G 09B 1X0
S52043800	F 01G 09B 0SB

S58B43800	F 01G 09B 1HP
S58D43800	F 01G 09B 1LZ
S61H43800	F 01G 09B 1N9
S61M43800	F 01G 09B 1M0
S62643800	F 01G 09B 0SC

S66043800	F 01G 09B 0SD
S66543800A	F 01G 09B 167
TA014343Z	F 01G 09C 1B0
TA0143800A	F 01G 09B 18B
TA044340Z	F 01G 09C 1AZ

TA044343Z	F 01G 09C 1M9
TC4443800	F 01G 09B 18D
TC8643800	F 01G 09B 18E
T0014340Z	F 01G 09C 1B3
T0014343Z	F 01G 09C 1B1

T0024340Z	F 01G 09C 1B4
T0434340ZA	F 01G 09C 1CX
T04343800	F 01G 09B 18C
T06043800A	F 01G 09B 1HS
UB7343800A	F 01G 09B 0SH

UB7343800B	F 01G 09B 0SM
UB9343800A	F 01G 09B 0SJ
UB9743800A	F 01G 09B 0SK
UC8643800A	F 01G 09B 15S
UD2043800A	F 01G 09B 15R

UE5443800A	F 01G 09B 0SL
UG4543800Z01	F 01G 09B 18G
UG5243800A	F 01G 09B 1J0
UG5243950B	F 01G 09B 1JC
UG7143800A	F 01G 09B 1CH

UG9743800	F 01G 09B 0SV
UK5943800	F 01G 09B 1J2
UK5943800A	F 01G 09B 1HU
UK6443800A	F 01G 09B 1HT
UT3A43800A	F 01G 09B 1HV

UV6043800	F 01G 09B 0V2
UV9643800A	F 01G 061 0MC
U00443800A	F 01G 09B 1HZ
U00543800	F 01G 09B 0U2
U01343800A	F 01G 09B 1CG

WG8443800B	F 01G 09B 1NX
WG8543800A	F 01G 09B 1LY
W06843800A	F 01G 09B 0LS
W20143800A	F 01G 09B 0TR
W21543800A	F 01G 09B 0UZ

W21843800A	F 01G 09B 0UY
W53043800	F 01G 09B 0UV
W55843800	F 01G 09B 0UW
W61241910	F 01G 09B 0KR
W62041910	F 01G 09B 0KS

W62043800A	F 01G 09B 1LX
W625437A0	F 01G 09D 0A7
W63643800	F 01G 09B 1NY
W63743800	F 01G 09B 1LW
W66343800A	F 01G 09B 1NW

W69343800	F 01G 09B 1NZ
0265006313	0 265 006 313
1E00-43-701A	0 986 594 023
1E00-43-701B	0 986 594 023
1E00-44-150	1 987 477 517

1E00-44-150A	1 987 477 517
1E00-44-410A	1 987 477 345
1E03-26-610	F 026 002 502
1E03-26-610	0 204 116 502
131243800A	F 01G 09B 0LV

317043800A	F 01G 09B 0LW
4084-41-920	0 986 486 523
8532-26-610	0 986 475 917
864 04809	F 01G 09B 1HW
885943800	F 01G 09B 0LX

MERCEDES-BENZ

000 290 32 12	0 986 486 053
000 295 34 07	0 986 486 502
000 295 36 07	0 986 486 502

000 295 40 07	0 986 486 502
000 295 41 07	0 986 486 502
000 295 50 06	0 986 486 013
000 295 59 07	0 986 486 502
000 295 60 06	0 986 486 013

000 295 63 07	0 986 486 502
000 295 65 07	0 986 486 502
000 295 66 06	0 986 486 013
000 295 68 07	0 986 486 502
000 295 76 07	0 986 486 547

000 295 77 06	0 986 486 013
000 295 80 07	0 986 486 545
000 295 82 07	0 986 486 502
000 295 88 07	0 986 486 545
000 295 89 07	0 986 486 545

000 295 91 06	0 986 486 023
000 295 96 06	0 986 486 021
000 420 09 79	0 204 102 910
000 420 10 79	0 204 102 911
000 420 11 83	0 986 472 680

000 420 50 83	0 986 471 655
000 420 51 83	0 986 472 655
000 420 53 83	0 986 472 655
000 420 55 83	0 986 471 678
000 420 56 83	0 986 472 678

000 420 57 83	0 986 471 656
000 420 58 83	0 986 472 656
000 420 59 83	0 986 471 656
000 420 60 83	0 986 472 656
000 420 61 83	0 986 471 658

000 420 62 83	0 986 472 658
000 420 64 83	0 986 471 679
000 420 65 83	0 986 472 679
000 420 74 83	0 986 471 971
000 420 75 83	0 986 471 972

000 420 84 83	0 986 471 748
000 420 85 83	0 986 471 749
000 420 89 01	0 986 471 979
000 420 90 01	0 986 471 980
000 420 91 01	0 986 471 979

000 420 92 01	0 986 471 980
000 420 92 83	0 986 471 967
000 420 93 01	0 986 471 979
000 420 93 83	0 986 471 968
000 420 94 01	0 986 471 980

000 423 23 98	0 986 471 196
000 423 24 98	0 986 472 196
000 423 25 98	0 986 471 196
000 423 26 98	0 986 472 196
000 423 31 98	0 986 471 196

000 423 33 98	0 986 471 196
000 423 34 98	0 986 472 196
000 423 47 98	0 986 471 196
000 423 58 98	0 986 471 196
000 423 64 98	0 986 472 196

000 423 70 98	0 986 471 196
000 423 71 98	0 986 472 196
000 423 72 98	0 986 471 196
000 423 73 98	0 986 472 196
000 423 89 98	0 986 471 969

000 423 90 98	0 986 471 970
000 423 91 98	0 986 471 196
000 423 92 98	0 986 472 196
000 426 63 98	0 986 471 196
000 428 26 35	1 987 476 224



000 428 35 35	1 987 476 396
000 428 66 35	1 987 476 077
000 428 79 35	1 987 476 390
000 428 80 35	1 987 476 077
000 430 01 16	0 265 202 110
000 430 56 01	F 026 003 484
000 430 58 01	F 026 003 366
000 430 58 01	0 204 123 366
000 430 59 01	0 204 123 367
000 430 64 01	F 026 003 484
000 430 65 01	F 026 003 484
000 431 07 27	0 204 125 741
000 431 08 27	0 204 125 556
000 431 11 27	0 204 125 556
000 431 15 27	0 204 125 741
000 431 17 27	0 204 024 668
000 431 17 27	0 204 051 088
000 431 19 27	0 204 051 341
000 431 41 12	0 204 131 323
000 431 44 12	0 204 131 325
000 431 58 01	F 026 003 366
000 431 58 01	0 204 123 366
000 431 59 01	0 204 123 367
000 431 63 01	0 204 123 370
000 431 63 01	0 204 123 485
000 431 64 01	F 026 003 484
000 431 65 01	F 026 003 484
000 431 69 01	0 204 123 643
000 431 73 01	0 204 255 049
000 431 76 01	0 204 051 514
000 446 05 89	0 265 216 444
000 446 08 89	0 265 220 489
000 446 11 89	0 265 220 491
000 446 13 89	0 265 224 018
000 446 17 89	0 265 224 088
000 446 22 89	0 265 224 043
000 446 22 89	0 265 224 090
000 446 26 14	0 265 216 444
000 446 26 89	0 265 224 082
000 446 31 89	0 265 224 086
000 446 33 89	0 265 224 086
000 446 35 89	0 265 224 043
000 446 35 89	0 265 224 090
000 446 37 89	0 265 224 088
000 446 43 89	0 265 224 076
000 446 43 89	0 265 224 092
000 446 45 89	0 265 224 078
000 446 45 89	0 265 224 086
000 446 51 89	0 265 224 068
000 446 51 89	0 265 224 086
000 446 53 89	0 265 224 070
000 446 53 89	0 265 224 090
000 446 55 89	0 265 224 072
000 446 55 89	0 265 224 088
000 446 57 89	0 265 224 086

000 446 59 89	0 265 224 082
000 446 61 89	0 265 224 088
000 446 63 89	0 265 224 090
000 446 65 89	0 265 224 092
000 446 67 89	0 265 225 210
000 446 67 89	0 265 225 306
000 446 67 89	0 265 225 347
000 446 69 89	0 265 225 225
000 446 75 89	0 265 225 298
000 446 75 89	0 265 225 331
000 446 77 89	0 265 225 221
000 446 79 89	0 265 225 302
000 446 83 89	0 265 234 098
000 446 85 89	0 265 234 100
000 446 87 89	0 265 234 102
000 446 89 89	0 265 234 104
000 446 91 89	0 265 225 306
000 446 91 89	0 265 225 347
000 446 93 89	0 265 225 300
000 446 95 89	0 265 225 304
000 540 04 17	0 265 001 240
000 540 10 17	0 265 001 239
000 540 11 17	0 265 001 240
000 542 45 19	0 332 512 003
000 542 65 18	0 265 005 201
000 586 38 43	1 987 472 073
000 586 38 43	1 987 472 294
000 800 71 75	0 928 400 068
000 800 75 75	0 928 400 086
000 800 80 75	0 928 400 095
000 824 31 99	3 390 329 001
000 824 36 95	3 390 329 003
000 824 36 99	3 390 329 003
001 2222 V002	0 265 225 376
001 2222 V003	0 265 225 376
001 2222 V0040	0 265 225 376
001 295 03 07	0 986 486 508
001 295 10 06	0 986 486 043
001 295 11 06	0 986 486 056
001 295 13 07	0 986 486 503
001 295 14 06	0 986 486 023
001 295 14 07	0 986 486 503
001 295 15 06	0 986 486 013
001 295 17 06	0 986 486 056
001 295 27 07	0 986 486 503
001 295 29 07	0 986 486 503
001 295 30 07	0 986 486 503
001 295 31 06	0 986 486 043
001 295 34 06	0 986 486 057
001 295 44 06	0 986 486 059
001 295 53 07	0 986 486 508
001 295 68 06	0 986 486 043
001 295 68 07	0 986 486 502
001 295 76 06	0 986 486 056
001 295 79 06	0 986 486 056

001 295 86 06	0 986 486 056
001 295 87 06	0 986 486 013
001 295 88 07	0 986 486 508
001 408 7V 00 1	0 265 005 303
001 420 09 79	0 204 102 910
001 420 10 79	0 204 102 911
001 420 10 83	0 986 471 680
001 420 11 83	0 986 472 680
001 420 14 83	0 986 471 681
001 420 15 83	0 986 472 681
001 420 43 83	0 986 471 816
001 420 44 83	0 986 471 817
001 420 45 83	0 986 471 818
001 420 46 83	0 986 471 819
001 420 62 83	0 204 102 915
001 420 63 83	0 204 102 914
001 420 64 83	0 204 102 916
001 420 65 83	0 204 102 917
001 420 67 83	0 204 102 918
001 420 68 83	0 204 102 919
001 420 69 83	0 204 102 912
001 420 70 83	0 204 102 913
001 420 95 18	0 986 475 783
001 421 36 98	0 986 471 860
001 421 37 98	0 986 471 861
001 421 77 98	0 986 471 860
001 421 78 98	0 986 471 861
001 421 86 98	0 986 471 860
001 421 87 98	0 986 471 861
001 423 46 98	0 986 471 951
001 423 47 98	0 986 471 952
001 428 14 35	1 987 476 234
001 428 88 35	1 987 476 235
001 428 94 35	1 987 476 077
001 428 95 35	1 987 476 392
001 430 60 01	0 986 480 918
001 430 68 01	0 986 480 918
001 431 67 12	0 265 200 027
001 431 80 12	0 265 200 027
001 446 08 89	0 265 225 331
001 446 10 89	0 265 225 347
001 446 13 89	0 265 235 003
001 446 13 89	0 265 235 168
001 446 15 89	0 265 235 168
001 446 19 89	0 265 235 001
001 446 36 89	0 265 235 028
001 446 40 89	0 265 235 028
001 540 44 17	0 265 005 220
001 540 44 17	0 265 005 258
001 540 45 17	0 265 005 231
001 540 45 17	0 265 005 258
001 542 42 18	0 265 004 011
001 542 43 18	0 265 004 012
001 542 45 18	0 265 004 015
001 542 67 19	0 332 205 004

001 542 89 19	0 332 002 288
001 542 90 18	0 265 005 220
001 542 90 18	0 265 005 258
001 545 46 18	0 265 004 016
001 586 04 43	1 987 472 073
001 586 04 43	1 987 472 294
001 586 93 43	1 987 472 294
002 153 62 28	0 261 231 009
002 153 74 28	0 261 231 024
002 153 84 28	0 261 231 026
002 295 04 07	0 986 486 508
002 295 06 07	0 986 486 546
002 295 08 07	0 986 486 544
002 295 13 07	0 986 486 547
002 295 21 07	0 986 486 546
002 295 22 07	0 986 486 544
002 420 41 83	0 204 001 955
002 420 42 83	0 204 001 956
002 420 57 83	0 204 102 912
002 420 58 83	0 204 102 913
002 420 88 18	0 986 475 779
002 421 05 98	0 986 471 708
002 421 06 98	0 986 472 708
002 421 18 98	0 986 471 860
002 421 19 98	0 986 471 861
002 421 23 98	0 986 471 860
002 421 24 98	0 986 471 861
002 421 30 98	0 986 471 708
002 421 31 98	0 986 472 708
002 421 38 98	0 986 471 981
002 421 39 98	0 986 471 982
002 421 40 98	0 986 471 979
002 421 41 98	0 986 471 980
002 423 11 98	0 986 471 976
002 423 12 98	0 986 471 975
002 430 19 01	0 986 480 918
002 430 25 30	0 986 485 018
002 430 26 30	0 986 485 018
002 430 27 30	0 986 485 018
002 430 28 01	0 986 480 246
002 430 45 30	0 986 485 018
002 430 46 30	0 986 485 018
002 430 53 30	0 986 485 018
002 430 82 01	0 986 480 918
002 430 88 01	0 986 480 918
002 431 02 12	0 481 099 016
002 431 15 12	0 265 200 027
002 431 20 12	0 265 202 014
002 431 35 12	0 265 201 027
002 431 37 12	0 265 201 026
002 431 40 12	0 265 201 047
002 431 42 12	0 265 201 042
002 431 45 12	0 265 202 014
002 431 53 12	0 265 201 031
002 431 90 12	0 204 131 250



◀ MERCEDES-BENZ

002 431 96 12	0 265 217 004	003 430 22 01	0 986 480 246	004 430 28 01	0 986 480 062	006 421 30 98	0 986 471 982
002 431 97 12	0 265 217 008	003 430 60 01	0 204 123 065	004 430 29 01	0 986 480 954	006 421 31 98	0 986 471 981
002 431 98 12	0 265 217 004	003 430 78 01	0 204 123 065	004 430 30 01	0 986 480 059	006 421 32 98	0 986 471 982
002 431 99 12	0 265 217 008	003 430 79 01	0 986 480 059	004 430 31 30	0 986 485 080	006 430 00 01	0 986 480 936
002 540 09 17	0 265 005 303	003 430 82 01	0 986 480 059	004 430 33 01	0 986 480 719	006 431 02 12	0 265 235 056
002 540 09 17	0 265 005 307	003 430 92 30	0 986 485 151	004 430 34 01	0 986 480 020	006 431 02 12	0 265 235 227
002 540 19 45	1 265 950 098	003 430 98 01	0 986 480 366	004 430 38 01	0 986 480 895	006 431 09 12	0 265 235 227
002 542 29 18	0 265 004 015	003 430 99 01	0 204 123 065	004 430 39 01	0 986 480 020	006 542 42 18	0 265 005 774
002 542 30 18	0 265 004 016	003 431 02 12	0 204 131 248	004 430 40 01	0 986 480 566	007 420 09 18	0 986 475 033
002 542 66 18	0 265 005 258	003 431 04 12	0 265 213 009	004 430 48 01	0 986 480 567	007 421 15 98	0 986 471 981
002 820 55 10	0 928 400 070	003 431 08 12	0 265 214 405	004 430 55 01	0 986 480 895	007 421 16 98	0 986 471 982
003 153 33 28	0 261 231 050	003 431 12 12	0 204 131 249	004 430 65 30	0 986 485 151	007 421 31 98	0 986 471 981
003 153 34 28	0 261 231 052	003 431 25 12	0 204 131 251	004 430 71 01	0 986 480 566	007 421 32 98	0 986 471 982
003 153 46 28	0 261 231 054	003 431 31 12	0 265 217 403	004 430 75 01	0 986 480 895	007 421 83 98	0 986 471 979
003 153 47 28	0 261 231 062	003 431 34 12	0 265 213 403	004 431 10 12	0 265 202 463	007 421 84 98	0 986 471 980
003 153 48 28	0 261 231 056	003 431 41 12	0 204 131 323	004 431 35 12	0 204 031 186	008 420 24 18	0 986 475 042
003 153 60 28	0 261 231 080	003 431 42 12	0 265 202 409	004 431 36 12	0 204 031 187	008 420 42 18	0 986 475 023
003 153 61 28	0 261 231 082	003 431 48 12	0 265 201 081	004 431 45 12	0 265 202 438	008 420 43 18	0 986 475 033
003 153 66 28	0 261 231 084	003 431 50 12	0 265 201 079	004 431 47 12	0 265 202 446	008 420 44 18	0 986 475 042
003 153 67 28	0 261 231 086	003 431 51 12	0 265 202 414	004 431 49 12	0 265 202 495	008 421 18 98	0 986 471 979
003 153 78 28	0 261 231 100	003 431 52 12	0 204 031 068	004 431 52 12	0 265 234 044	008 421 19 98	0 986 471 980
003 153 80 28	0 261 231 098	003 431 56 12	0 265 217 413	005 420 78 18	0 986 475 780	008 421 20 98	0 986 471 979
003 153 86 28	0 261 231 110	003 431 81 12	0 265 202 441	005 420 79 18	0 986 475 782	008 421 21 98	0 986 471 980
003 153 89 28	0 261 231 188	003 431 88 12	0 265 202 446	005 420 81 18	0 986 475 023	009 420 05 18	0 986 475 782
003 341 04 12	0 265 213 009	003 431 91 12	0 265 202 438	005 420 82 18	0 986 475 785	009 420 06 18	0 986 475 780
003 420 01 83	0 204 204 787	003 431 93 12	0 265 202 451	005 420 83 18	0 986 475 784	009 420 07 18	0 986 475 779
003 420 02 83	0 204 204 788	003 431 95 12	0 265 202 451	005 430 02 01	0 986 480 915	009 420 08 18	0 986 475 782
003 420 08 18	0 986 475 782	003 431 97 12	0 265 202 466	005 430 24 01	0 986 480 020	009 420 11 18	0 986 475 042
003 420 71 83	0 204 004 519	003 542 03 18	0 265 005 298	005 430 26 01	0 986 480 719	009 420 81 18	0 986 475 033
003 420 72 83	0 204 004 520	003 542 03 18	0 265 005 642	005 430 40 01	0 986 480 896	009 420 82 18	0 986 475 779
003 420 73 83	0 204 004 523	003 542 05 18	0 265 005 303	005 430 59 01	0 986 480 351	009 420 83 18	0 986 475 780
003 420 74 83	0 204 004 524	003 545 74 32	0 265 101 017	005 430 62 01	0 986 480 721	009 420 84 18	0 986 475 782
003 420 98 18	0 986 475 785	003 545 74 32	0 265 101 019	005 430 64 01	0 986 480 722	009 420 87 18	0 986 475 779
003 421 00 98	0 986 471 708	003 545 74 32	0 265 101 021	005 430 65 01	0 986 480 723	009 420 88 18	0 986 475 780
003 421 01 98	0 986 472 708	004 153 09 28	0 261 231 133	005 430 72 01	0 986 480 724	009 420 89 18	0 986 475 782
003 421 06 98	0 986 471 708	004 153 62 28	0 261 231 128	005 430 77 01	0 986 480 937	009 542 62 17	0 265 002 040
003 421 07 98	0 986 472 708	004 153 90 28	0 261 231 188	005 430 83 01	0 986 480 934	009 542 62 17	0 265 002 076
003 421 10 98	0 986 471 862	004 420 12 18	0 986 475 784	005 431 92 12	1 267 000 933	009 542 62 17	0 265 002 230
003 421 11 98	0 986 471 863	004 420 37 18	0 986 475 782	005 431 93 12	1 267 000 934	009 542 62 17	0 265 005 040
003 421 24 98	0 986 471 750	004 420 62 18	0 986 475 779	005 542 26 18	0 265 005 749	009 545 29 32	0 265 105 022
003 421 25 98	0 986 471 751	004 421 78 98	0 986 471 979	005 542 27 18	0 265 005 753	010 542 49 17	0 265 005 018
003 421 39 98	0 986 471 979	004 421 79 98	0 986 471 980	005 545 21 32	0 265 101 019	010 542 51 17	0 265 005 107
003 421 40 98	0 986 471 980	004 421 82 98	0 986 471 981	005 545 21 32	0 265 101 021	010 545 44 32	0 265 105 026
003 421 41 98	0 986 471 981	004 421 83 98	0 986 471 982	005 545 51 32	0 265 101 021	011 420 00 18	0 986 475 044
003 421 42 98	0 986 471 982	004 430 08 01	0 986 480 060	005 545 52 32	0 265 101 023	011 420 01 18	0 986 475 044
003 421 43 98	0 986 471 981	004 430 09 01	0 204 123 065	006 153 36 28	0 261 231 188	011 420 88 18	0 986 475 033
003 421 44 98	0 986 471 982	004 430 12 01	0 986 480 366	006 421 17 98	0 986 471 981	011 542 46 17	0 265 005 107
003 421 45 98	0 986 471 979	004 430 13 01	0 986 480 060	006 421 18 98	0 986 471 982	011 545 47 32	0 265 106 039
003 421 46 98	0 986 471 980	004 430 17 01	0 986 480 351	006 421 19 98	0 986 471 981	011 545 48 32	0 265 106 041
003 421 47 98	0 986 471 979	004 430 18 01	0 204 123 232	006 421 20 98	0 986 471 982	012 542 04 17	0 265 005 114
003 421 48 98	0 986 471 980	004 430 22 01	0 986 480 917	006 421 21 98	0 986 471 979	012 542 43 17	0 265 005 040
003 421 49 98	0 986 471 981	004 430 23 01	0 204 123 065	006 421 22 98	0 986 471 980	012 545 74 32	0 265 101 041
003 421 50 98	0 986 471 982	004 430 24 01	0 986 480 351	006 421 23 98	0 986 471 979	013 545 26 32	0 265 106 057
003 430 04 01	0 986 480 909	004 430 25 01	0 204 123 065	006 421 24 98	0 986 471 980	013 545 92 32	0 265 101 045
003 430 15 30	0 986 485 080	004 430 26 01	0 986 480 061	006 421 29 98	0 986 471 981	013 545 93 32	0 265 101 047

016 545 71 32	0 265 109 071
017 545 79 32	0 265 108 018
018 545 76 32	0 265 109 019
019 545 46 32	0 265 108 029
020 545 47 32	0 265 108 032
021 545 29 32	0 265 109 034
021 545 32 32	0 265 109 455
021 545 32 32	0 265 109 493
022 545 64 32	0 265 109 452
022 545 64 32	0 265 109 487
022 545 71 32	0 265 109 425
022 545 71 32	0 265 109 459
022 545 71 32	0 265 109 464
022 545 71 32	0 265 109 468
022 545 99 32	0 265 109 064
023 545 00 32	0 265 109 071
023 545 05 32	0 265 109 070
024 545 06 32	0 265 109 452
024 545 06 32	0 265 109 487
024 545 07 32	0 265 109 503
024 545 62 32	0 265 109 452
024 545 62 32	0 265 109 487
024 545 64 32	0 265 109 447
024 545 66 32	0 265 109 447
025 431 19 12	0 265 202 014
026 520 21 09	0 265 005 300
026 545 36 32	0 265 109 459
026 545 36 32	0 265 109 464
026 545 55 32	0 265 109 436
026 545 56 32	0 265 109 437
026 545 56 32	0 265 109 488
026 545 57 32	0 265 109 438
026 545 57 32	0 265 109 486
026 545 58 32	0 265 109 439
026 545 59 32	0 265 109 440
026 545 60 32	0 265 109 482
026 545 61 32	0 265 109 441
026 545 61 32	0 265 109 494
026 545 63 32	0 265 109 469
026 545 64 32	0 265 109 466
026 545 64 32	0 265 109 499
027 545 31 32	0 265 109 451
027 545 31 32	0 265 109 484
027 545 32 32	0 265 109 452
027 545 32 32	0 265 109 487
027 545 41 32	0 265 109 477
027 545 56 32	0 265 109 451
027 545 56 32	0 265 109 484
027 545 57 32	0 265 109 452
027 545 57 32	0 265 109 487
027 545 58 32	0 265 109 455
027 545 58 32	0 265 109 493
027 545 60 32	0 265 109 459
027 545 60 32	0 265 109 464
027 545 60 32	0 265 109 468

027 545 63 32	0 265 109 503
027 545 95 32	0 265 109 466
027 545 95 32	0 265 109 499
028 545 26 32	0 265 109 459
028 545 26 32	0 265 109 464
028 545 84 32	0 265 109 503
028 545 85 32	0 265 109 464
028 545 85 32	0 265 109 468
029 545 08 32	0 265 109 499
029 545 22 32	0 265 109 469
029 545 23 32	0 265 109 466
029 545 23 32	0 265 109 499
029 545 42 32	0 265 109 477
029 545 45 32	0 265 109 492
029 545 47 32	0 265 109 468
029 545 48 32	0 265 109 606
029 545 48 32	0 265 109 619
029 545 48 32	0 265 109 630
029 545 51 32	0 265 109 499
029 545 62 32	0 265 109 456
029 545 62 32	0 265 109 483
029 545 63 32	0 265 109 471
029 545 71 32	0 265 109 482
029 545 72 32	0 265 109 483
029 545 73 32	0 265 109 484
029 545 75 32	0 265 109 486
029 545 76 32	0 265 109 487
029 545 77 32	0 265 109 488
029 545 78 32	0 265 109 489
029 545 81 32	0 265 109 493
029 545 82 32	0 265 109 494
029 545 83 32	0 265 109 606
029 545 83 32	0 265 109 619
029 545 83 32	0 265 109 630
031 545 06 32	0 265 109 501
031 545 08 32	0 265 109 499
031 545 19 32	0 265 109 601
031 545 41 32	0 265 109 507
033 545 41 32	0 265 109 516
033 545 42 32	0 265 109 518
033 545 43 32	0 265 109 519
107 420 00 83	0 986 471 750
107 420 01 83	0 986 471 751
107 540 00 17	0 265 001 012
107 540 02 17	0 265 001 128
107 540 03 17	0 265 001 126
107 540 04 17	0 265 002 256
116 420 00 83	0 986 471 860
116 420 01 83	0 986 471 861
116 428 01 35	1 987 476 234
116 540 06 17	0 265 002 001
116 540 08 17	0 265 001 001
116 540 09 17	0 265 001 003
123 420 01 83	0 986 471 708
123 420 02 83	0 986 472 708

123 420 02 85	1 987 477 009
123 420 03 83	0 204 102 220
123 420 04 83	0 204 102 221
123 420 04 85	1 987 477 011
123 420 05 83	0 986 471 196
123 420 05 83	0 986 471 961
123 420 05 85	1 987 477 010
123 420 06 83	0 986 471 962
123 420 06 83	0 986 472 196
123 420 07 83	0 986 471 196
123 420 07 83	0 986 471 961
123 420 08 83	0 986 471 962
123 420 08 83	0 986 472 196
123 420 09 83	0 986 471 196
123 420 09 83	0 986 471 961
123 420 10 83	0 986 471 962
123 420 10 83	0 986 472 196
123 420 11 83	0 986 471 969
123 420 12 83	0 986 471 970
123 420 13 85	1 987 477 206
123 420 14 83	0 986 471 196
123 420 14 83	0 986 471 961
123 420 14 83	0 986 473 752
123 420 15 83	0 986 471 962
123 420 15 83	0 986 472 196
123 428 01 35	1 987 476 396
123 428 02 35	1 987 476 235
123 428 03 35	1 987 476 077
123 428 05 35	1 987 476 077
123 428 06 35	1 987 476 393
124 420 00 83	0 986 471 963
124 420 01 83	0 986 471 964
124 420 02 83	0 986 471 951
124 420 03 83	0 986 471 952
124 420 10 05	1 987 477 306
124 420 11 85	1 987 477 047
124 420 25 85	1 987 477 325
124 420 26 85	1 987 477 306
124 540 01 17	0 265 001 111
124 540 02 17	0 265 001 109
124 540 02 17	0 265 001 282
124 540 04 17	0 265 002 208
124 540 06 17	0 265 001 154
124 540 06 17	0 265 001 155
124 540 07 17	0 265 001 152
124 540 07 17	0 265 001 153
124 540 14 17	0 265 001 300
124 540 15 17	0 265 001 298
124 540 16 17	0 265 001 284
124 540 17 17	0 265 001 282
124 540 19 17	0 265 002 208
124 540 20 17	0 265 002 082
124 540 20 17	0 265 002 210
124 540 21 17	0 265 002 086
124 540 21 17	0 265 002 206

124 540 22 17	0 265 002 084
124 540 22 17	0 265 002 204
124 540 23 17	0 265 002 238
124 540 24 17	0 265 002 236
124 540 25 17	0 265 002 244
124 540 29 17	0 265 006 128
124 540 30 17	0 265 006 126
124 540 31 17	0 265 006 111
124 540 32 17	0 265 006 109
124 824 32 99	3 390 329 001
126 420 00 83	0 986 471 862
126 420 01 83	0 986 471 863
126 420 02 83	0 204 102 222
126 420 03 83	0 204 102 579
126 420 06 83	0 986 471 864
126 420 07 83	0 986 471 865
126 420 08 83	0 204 102 255
126 420 09 83	0 204 102 256
126 420 14 83	0 986 471 196
126 420 16 85	1 987 477 212
126 420 17 85	1 987 477 213
126 428 01 35	1 987 476 234
126 428 03 35	1 987 476 396
126 540 00 17	0 265 002 004
126 540 02 17	0 265 001 020
126 540 02 17	0 265 001 030
126 540 04 17	0 265 001 016
126 540 05 17	0 265 001 018
126 540 16 17	0 265 001 021
126 540 17 17	0 265 001 014
126 540 17 17	0 265 001 020
126 540 25 17	0 265 001 280
126 540 26 17	0 265 001 278
126 540 30 17	0 265 002 260
126 540 32 17	0 265 002 088
126 540 32 17	0 265 002 258
129 420 02 83	0 986 471 963
129 420 03 83	0 986 471 964
129 420 08 85	1 987 477 812
129 420 09 85	1 987 477 814
129 420 27 85	1 987 477 811
129 428 00 35	1 987 476 393
129 428 10 35	1 987 481 080
129 540 13 17	0 265 002 224
129 540 14 17	0 265 002 222
129 540 15 17	0 265 002 052
129 540 15 17	0 265 002 202
129 540 16 17	0 265 002 214
129 540 20 17	0 265 002 114
129 540 21 17	0 265 002 112
129 540 26 17	0 265 006 132
129 540 27 17	0 265 006 130
129 540 29 17	0 265 006 186
129 540 30 17	0 265 006 184
129 540 35 17	0 265 006 280



◀ MERCEDES-BENZ

129 540 36 17	0 265 006 292	168 428 02 35	1 987 476 118	201 540 13 17	0 265 002 076	210 540 07 17	0 265 006 194
140 420 00 48	1 987 476 752	168 428 03 35	1 987 476 760	201 540 13 17	0 265 002 230	210 540 10 17	0 265 006 240
140 420 09 85	1 987 477 749	168 428 06 35	1 987 476 083	201 540 15 17	0 265 001 288	210 540 48 10	0 265 006 358
140 420 10 85	1 987 477 750	168 430 00 01	0 986 480 936	201 540 16 17	0 265 001 286	210 540 49 10	0 265 006 356
140 420 14 85	1 987 477 844	168 430 01 01	0 986 480 936	201 540 19 17	0 265 002 228	210 540 90 08	0 265 006 190
140 420 19 85	1 987 477 749	168 430 02 01	0 986 480 936	201 540 20 17	0 265 002 226	210 540 91 08	0 265 006 188
140 420 20 85	1 987 477 750	168 540 00 17	0 265 006 370	201 540 22 17	0 265 002 076	211 420 01 85	1 987 477 851
140 420 31 85	1 987 477 844	168 540 01 17	0 265 006 368	201 540 22 17	0 265 002 230	211 420 02 85	1 987 477 897
140 440 07 32	0 265 001 406	168 540 03 17	0 265 006 372	201 540 23 17	0 265 002 232	211 420 03 85	1 987 477 897
140 440 09 32	0 265 001 402	168 545 08 32	0 265 109 606	202 290 00 11	0 986 486 535	211 420 05 48	1 987 476 841
140 540 02 17	0 265 002 220	168 545 08 32	0 265 109 619	202 290 01 12	0 986 486 043	211 420 05 85	1 987 477 898
140 540 03 17	0 265 002 248	168 545 08 32	0 265 109 630	202 420 01 48	1 987 476 778	211 420 17 85	1 987 477 851
140 540 07 17	0 265 002 234	168 545 09 32	0 265 109 610	202 420 01 85	1 987 477 219	211 420 18 85	1 987 477 898
140 540 08 17	0 265 002 216	168 545 13 32	0 265 109 619	202 420 02 85	1 987 477 220	211 540 00 17	0 265 007 433
140 540 11 17	0 265 002 218	168 545 13 32	0 265 109 630	202 420 16 85	1 987 477 699	211 540 04 17	0 265 007 434
140 540 12 09	0 265 001 296	168 545 35 32	0 265 109 630	202 420 22 85	1 987 477 219	211 540 12 17	0 265 007 500
140 540 13 09	0 265 001 293	169 420 09 85	1 987 477 223	202 420 23 85	1 987 477 220	211 540 13 17	0 265 007 499
140 540 13 09	0 265 001 294	169 420 11 85	1 987 477 224	202 420 28 85	1 987 477 220	211 540 18 17	0 265 007 698
140 540 15 09	0 265 001 348	169 420 12 85	1 987 477 225	202 420 29 85	1 987 477 699	211 540 19 17	0 265 007 700
140 540 16 09	0 265 001 350	169 420 16 85	1 987 477 223	202 420 30 85	1 987 477 700	211 540 23 17	0 265 007 745
140 540 17 09	0 265 001 350	169 420 17 85	1 987 477 223	202 420 32 85	1 987 477 896	211 540 23 17	0 265 008 097
140 540 20 17	0 265 006 182	169 428 00 35	1 987 476 453	202 420 33 85	1 987 477 700	211 540 24 17	0 265 007 746
140 540 21 17	0 265 006 180	169 540 04 17	0 265 007 478	202 420 33 85	1 987 477 921	211 540 29 17	0 265 008 097
140 540 28 17	0 265 001 410	169 540 08 17	0 265 007 480	202 428 07 35	1 987 476 439	211 540 30 17	0 265 008 098
140 540 29 17	0 265 001 408	170 420 03 85	1 987 477 628	202 540 01 17	0 265 002 212	211 545 02 32	0 265 109 502
140 540 34 17	0 265 006 276	170 420 04 85	1 987 477 629	202 540 02 17	0 265 002 124	211 821 19 58	0 265 004 011
140 540 35 17	0 265 006 274	171 420 01 85	1 987 482 022	202 540 03 17	0 265 001 360	216 542 00 18	0 265 005 642
163 420 02 85	1 987 477 902	171 420 02 085	1 987 482 023	202 540 04 17	0 265 001 358	220 420 00 48	1 987 476 949
163 420 03 85	1 987 477 905	182 305 03 10	0 986 475 778	202 540 05 17	0 265 001 370	220 420 01 48	1 987 476 950
163 420 07 48	1 987 476 080	182 305 33 10	0 986 475 778	202 540 06 17	0 265 001 368	220 420 09 85	1 987 477 901
163 420 07 85	1 987 477 903	199 545 00 32	0 265 109 509	202 540 12 17	0 265 006 192	220 420 27 85	1 987 477 899
163 420 08 48	1 987 481 077	201 290 00 11	0 986 486 503	202 540 13 17	0 265 006 172	220 420 28 85	1 987 477 900
163 420 08 85	1 987 477 904	201 290 01 11	0 986 486 503	202 540 16 17	0 265 006 242	220 540 01 17	0 265 007 002
163 420 09 48	1 987 481 078	201 290 03 11	0 986 486 503	202 540 17 17	0 265 006 248	220 540 02 17	0 265 007 002
163 420 13 48	1 987 476 081	201 290 04 11	0 986 486 535	202 540 18 17	0 265 006 246	220 540 04 17	0 265 007 008
163 420 14 48	1 987 481 078	201 290 05 11	0 986 486 535	202 540 20 17	0 265 006 266	220 540 05 17	0 265 007 006
163 420 18 48	1 987 481 077	201 420 00 83	0 986 471 951	202 540 21 17	0 265 006 264	220 540 17 17	0 265 007 121
163 420 19 48	1 987 481 078	201 420 01 83	0 986 471 952	202 540 34 17	0 265 006 685	220 540 18 17	0 265 007 123
164 420 03 85	1 987 482 024	201 420 02 83	0 986 471 951	202 540 71 10	0 265 006 174	220 540 20 17	0 265 007 128
164 420 23 85	1 987 482 024	201 420 03 83	0 986 471 952	202 540 78 08	0 265 002 126	220 545 16 32	0 265 109 608
168 290 01 12	0 986 486 029	201 420 04 83	0 986 471 951	203 290 01 12	0 986 486 064	220 545 17 32	0 265 109 609
168 290 02 12	0 986 486 029	201 420 05 83	0 986 471 952	203 290 02 12	0 986 486 064	220 545 18 32	0 265 109 607
168 290 04 12	0 986 486 029	201 420 06 85	1 987 477 047	203 420 01 85	1 987 477 845	220 545 18 32	0 265 109 745
168 290 05 12	0 986 486 108	201 420 07 85	1 987 477 324	203 420 02 85	1 987 477 846	220 545 25 32	0 265 109 743
168 420 00 18	0 986 475 870	201 420 11 85	1 987 477 047	203 420 03 85	1 987 477 847	220 545 27 32	0 265 109 746
168 420 01 18	0 986 475 875	201 540 00 17	0 265 002 008	203 420 06 85	1 987 477 848	220 545 35 32	0 265 109 745
168 420 06 85	1 987 477 809	201 540 01 17	0 265 001 051	203 420 09 85	1 987 477 845	220 545 39 32	0 265 109 773
168 420 07 85	1 987 477 810	201 540 01 17	0 265 001 128	207 540 00 17	0 265 008 138	230 540 04 17	0 265 007 501
168 420 13 85	1 987 477 960	201 540 02 17	0 265 001 049	207 540 03 17	0 265 008 140	230 540 04 17	0 265 007 694
168 420 14 85	1 987 477 692	201 540 02 17	0 265 001 114	210 420 08 85	1 987 477 701	230 540 07 17	0 265 007 501
168 420 15 85	1 987 477 691	201 540 07 17	0 265 001 051	210 420 14 85	1 987 477 849	230 540 07 17	0 265 007 694
168 420 16 85	1 987 477 962	201 540 07 17	0 265 001 128	210 420 15 85	1 987 477 850	230 540 08 17	0 265 007 502
168 420 17 85	1 987 477 692	201 540 08 17	0 265 001 049	210 420 18 85	1 987 477 701	230 540 08 17	0 265 007 585
168 420 19 85	1 987 477 809	201 540 08 17	0 265 001 114	210 428 00 35	1 987 476 427	230 540 10 17	0 265 007 585
168 420 20 85	1 987 477 961	201 540 13 17	0 265 002 040	210 540 06 17	0 265 006 178	230 540 11 17	0 265 007 635



230 540 12 17	0 265 007 694
230 540 13 17	0 265 007 696
230 540 15 17	0 265 007 743
230 540 16 17	0 265 007 744
309 420 17 85	1 987 477 120

314 420 00 18	0 986 475 783
314 420 01 18	0 986 475 783
314 420 02 18	0 986 475 783
314 420 03 18	0 986 475 783
314 420 04 18	0 986 475 783

314 420 05 18	0 986 475 783
414 420 01 85	1 987 482 130
414 428 00 35	1 987 476 082
414 446 00 53	0 265 109 472
414 446 01 53	0 265 109 617

416 421 02 98	0 986 471 976
416 421 03 98	0 986 471 975
416 421 06 98	0 986 471 976
416 421 07 98	0 986 471 975
419 421 04 98	0 986 471 976

419 421 05 98	0 986 471 975
419 421 10 98	0 986 471 975
427 421 04 98	0 986 471 976
427 421 05 98	0 986 471 975
435 421 04 98	0 986 471 975

435 421 05 98	0 986 471 976
451 542 00 18	0 265 005 688
451 542 00 18	0 265 005 774
451 542 01 18	0 265 005 687
454 420 11 26	1 987 481 054

454 420 12 75	0 265 234 316
454 420 12 75	0 265 234 500
454 420 13 75	0 265 231 530
454 420 17 75	0 265 234 500
454 420 19 26	1 987 481 055

454 420 23 75	0 265 235 099
454 542 03 18	0 265 007 638
454 542 04 18	0 265 005 600
454 542 04 18	0 265 005 687
454 542 05 18	0 265 007 637

454 542 06 18	0 265 007 683
460 428 01 35	1 987 476 024
460 428 51 35	1 987 476 446
463 428 02 35	1 987 476 235
463 545 14 32	0 265 109 495

463 545 16 32	0 265 109 625
463 545 22 32	0 265 109 766
463 545 23 32	0 265 109 765
545 420 05 75	0 265 234 257
545 420 05 75	0 265 234 316

545 420 05 75	0 265 234 500
545 420 06 74	0 265 231 530
601 420 04 11	1 987 477 208
601 420 11 85	1 987 477 211
601 420 15 85	1 987 477 328

601 420 16 85	1 987 477 208
601 420 17 85	1 987 477 209
601 420 36 85	1 987 477 119
601 420 46 85	1 987 477 119
601 420 47 85	1 987 477 118

602 090 04 66	0 928 400 285
608 420 03 18	0 986 475 778
611 420 16 85	1 987 477 122
611 420 17 85	1 987 477 121
631 290 00 12	0 986 486 058

631 420 00 18	0 986 475 662
631 420 00 83	0 204 102 322
631 420 01 83	0 204 102 323
631 420 04 83	0 204 102 371
631 420 05 83	0 204 102 372

631 420 10 83	0 204 102 371
631 420 11 83	0 204 102 372
631 420 12 85	1 987 477 117
631 420 19 85	1 987 477 327
631 420 20 85	1 987 477 326

631 420 21 85	1 987 477 117
631 420 32 83	0 204 102 371
631 420 33 83	0 204 102 372
631 428 00 35	1 987 481 094
631 428 02 35	1 987 481 030

631 430 02 01	0 204 123 246
631 430 07 01	0 986 480 725
631 430 11 01	0 986 480 726
631 430 11 81	0 204 031 300
631 431 01 12	0 265 201 040

638 427 03 38	1 987 477 199
638 428 08 35	1 987 481 005
638 428 10 35	1 987 481 007
638 428 21 35	1 987 481 007
638 428 22 35	1 987 481 005

638 431 04 12	0 204 131 322
638 446 02 14	0 265 220 054
638 446 03 14	0 265 220 054
638 542 02 17	0 265 006 214
638 542 03 17	0 265 006 195

638 542 04 17	0 265 006 215
639 420 00 83	0 204 204 673
639 420 01 83	0 204 204 674
639 420 04 83	0 204 205 233
639 420 05 83	0 204 205 234

639 420 06 83	0 204 004 513
639 420 07 83	0 204 004 514
639 420 08 83	0 204 004 515
639 420 08 83	0 204 204 675
639 420 09 83	0 204 004 516

639 420 09 83	0 204 204 676
639 420 10 83	0 204 004 513
639 420 11 83	0 204 004 514
639 420 13 85	1 987 477 197
639 420 14 85	1 987 477 198

639 427 04 38	1 987 482 026
639 427 05 38	1 987 482 025
639 428 03 35	1 987 481 006
639 428 04 35	1 987 481 001
639 542 00 18	0 265 005 429

639 542 07 18	0 265 005 523
667 420 29 01	0 986 471 979
667 420 30 01	0 986 471 980
667 420 31 01	0 986 471 979
667 420 32 01	0 986 471 980

667 420 35 01	0 986 471 979
667 420 36 01	0 986 471 980
667 420 37 01	0 986 471 979
667 420 38 01	0 986 471 980
667 420 46 85	1 987 477 703

667 420 47 85	1 987 477 702
667 420 60 01	0 986 471 979
667 420 61 01	0 986 471 980
667 420 62 01	0 986 471 979
667 420 63 01	0 986 471 980

667 428 01 35	1 987 476 391
668 420 28 85	1 987 477 126
668 420 29 85	1 987 477 125
668 420 42 85	1 987 477 126
668 420 43 85	1 987 477 125

669 420 20 01	0 986 471 941
669 420 21 01	0 986 471 942
669 420 24 01	0 986 471 941
669 420 25 01	0 986 471 942
669 420 26 01	0 986 471 941

669 420 27 01	0 986 471 942
669 420 28 01	0 986 471 941
669 420 29 01	0 986 471 942
669 420 30 01	0 986 471 941
669 420 31 01	0 986 471 942

669 420 44 01	0 986 471 941
669 420 45 01	0 986 471 942
669 420 46 01	0 986 471 941
669 420 47 01	0 986 471 942
901 420 18 85	1 987 477 852

901 420 20 85	1 987 477 853
901 420 21 85	1 987 477 854
901 420 22 85	1 987 477 855
901 420 27 85	1 987 477 856
901 420 28 85	1 987 477 857

901 428 02 35	1 987 476 295
901 428 04 35	1 987 476 295
901 428 08 35	1 987 476 296
901 428 08 35	1 987 476 300
901 428 91 35	1 987 476 294

901 542 05 18	0 265 004 019
901 542 05 18	0 265 004 022
901 542 08 17	0 265 004 008
901 542 08 17	0 265 004 009
901 542 11 17	0 265 004 010

901 542 13 18	0 265 004 028
901 542 14 18	0 265 004 029
901 542 17 17	0 265 004 009
904 420 01 85	1 987 477 858
904 420 02 85	1 987 477 859

904 420 03 85	1 987 482 131
904 420 04 85	1 987 477 880
904 420 05 85	1 987 477 860
904 420 06 85	1 987 477 861
904 428 04 35	1 987 481 008

906 420 20 85	1 987 482 032
906 420 22 85	1 987 482 028
906 420 23 85	1 987 482 029
906 420 26 85	1 987 482 030
906 420 30 85	1 987 482 033

906 420 31 85	1 987 482 034
906 428 05 35	1 987 476 300
906 428 06 35	1 987 476 297
906 542 05 18	0 265 005 628
906 542 42 18	0 265 005 774

MITSUBISHI	
CW720417	0 265 216 498
CW721547	0 265 216 498
CW 725334	0 265 006 520

CW 725335	0 265 006 521
CW 725336	0 265 006 522
CW 725337	0 265 006 523
MA305300	F 01G 09C 0GN
MA305301	F 01G 09C 0GP

MA314383	F 01G 09C 0NW
MA314384	F 01G 09C 0NY
MA314565	F 01G 09C 0NX
MB003801	F 01G 09C 0K3
MB003806	F 01G 09C 0K7

MB058509	1 987 476 501
MB058553	0 986 475 663
MB058592	1 987 476 737
MB058593	1 987 476 501
MB058776	F 01G 09C 0KB

MB060962	F 01G 09C 1EF
MB081620	F 01G 09C 0KC
MB082062	F 01G 09C 0K6
MB082157	1 987 476 502
MB128624	0 986 475 663

MB150762	1 987 481 031
MB162215	F 01G 09C 1EG
MB193230	F 01G 09C 0KH
MB193234	F 01G 09C 1JE
MB193411	0 986 475 663

MB238081	F 01G 09C 1FB
MB238081	0 986 480 728
MB238151	1 987 476 502
MB238157	1 987 476 502
MB238158	1 987 476 502



◀ MITSUBISHI

MB238160	1 987 476 737
MB238161	1 987 476 501
MB238162	1 987 476 501
MB238164	1 987 476 501
MB238166	1 987 476 501

MB238425	1 987 481 095
MB238428	1 987 481 011
MB238510	0 986 475 718
MB238511	0 986 475 719
MB238828	0 986 475 922

MB238829	0 986 475 921
MB256179	1 987 477 514
MB256867	1 987 482 067
MB256875	1 987 482 066
MB277336	F 01G 09C OKP

MB277337	F 01G 09C OKR
MB277341	F 01G 09B OP1
MB277735	F 01G 09C 1GN
MB277750	F 01G 09B OMP
MB316241	F 01G 09C 1FC

MB316242	F 01G 09C OKU
MB316248	F 01G 09C OKV
MB316287	1 987 476 738
MB316369	0 986 480 728
MB366139	0 986 475 665

MB366326	0 986 475 666
MB366910	F 01G 09B OW7
MB407044	F 01G 09B ON8
MB407045	F 01G 09B ON9
MB407061	0 986 480 729

MB407756	F 01G 09C OMU
MB407783	F 01G 09B OS5
MB435508	F 01G 09E 004
MB500404	0 986 480 730
MB500452	1 987 476 194

MB500484	0 986 475 718
MB500485	0 986 475 719
MB500601	F 01G 09B OS1
MB500670	F 01G 09C ONR
MB500672	F 01G 09C 1M6

MB500703	F 01G 09C ONF
MB500738	0 986 475 920
MB500739	0 986 475 919
MB520341	1 987 477 674
MB 520341C	1 987 477 674

MB520342	1 987 477 675
MB 520342C	1 987 477 675
MB534020	0 986 480 733
MB534454	F 01G 09B OW8
MB534480	0 986 480 734

MB534702	F 01G 09C 1F8
MB534737	F 01G 09D 001
MB534828	F 01G 09B 17T
MB534848	F 01G 09B OTG
MB534849	F 01G 09B OS2

MB534870	F 01G 09B OP2
MB534871	F 01G 09B OP3
MB587022	0 986 480 842
MB587505	F 01G 09C OPJ
MB587632	F 01G 09C 1AT

MB587641	F 01G 09B OX1
MB587740	1 987 476 501
MB587742	1 987 476 194
MB587753	1 987 476 502
MB587754	1 987 476 502

MB587810	F 01G 09B 17S
MB618064	F 01G 09B ORY
MB618076	F 01G 09B OMR
MB618118	F 01G 09C 1GP
MB618188	0 986 475 914

MB618570	F 01G 09B 17N
MB618702	F 01G 09B OTH
MB618704	F 01G 09B 17M
MB618706	F 01G 09B OS3
MB618708	F 01G 09B OP5

MB618718	F 01G 09B OTK
MB618970	F 01G 09B ONA
MB618973	F 01G 09B OP8
MB618974	F 01G 09B OP9
MB618975	F 01G 09B OXY

MB618978	F 01G 09B OS6
MB618981	0 986 475 668
MB618990	F 01G 09D 00B
MB668066	F 01G 09B OS8
MB668266	F 01G 09D 016

MB668391	F 01G 09D 014
MB668392	F 01G 09D 00C
MB668446	F 01G 09B 150
MB668502	F 01G 09B ON6
MB668503	F 01G 09B ON7

MB668506	F 01G 09B OP6
MB668680	F 01G 09B 100
MB668870	F 01G 09D 019
MB668871	F 01G 09D 00D
MB668899	0 986 480 844

MB668927	F 01G 09C OTZ
MB668960	F 01G 09B 151
MB699130	F 01G 09B OXZ
MB699269	F 01G 09B 17P
MB699299	F 01G 09B 15H

MB699344	F 01G 09B OTJ
MB699391	F 01G 09D 03X
MB699420	F 01G 09B 152
MB699421	F 01G 09B 153
MB699422	F 01G 09B 17X

MB699435	F 01G 09D 03Y
MB699437	F 01G 09D 008
MB699558	1 987 481 121
MB699570	F 01G 09B 17U
MB699972	F 01G 09D 01C

MB699973	F 01G 09D 00E
MB806051	1 987 482 163
MB841010	F 01G 09B 107
MB841013	F 01G 09B 108
MB841017	F 01G 09B 185

MB841018	F 01G 09B 186
MB841019	F 01G 09B 187
MB857390	0 986 480 662
MB857402	F 01G 09B 101
MB857426	1 987 476 784

MB857524	1 987 476 502
MB857526	1 987 476 502
MB857541	1 987 476 502
MB857551	1 987 476 193
MB857552	1 987 481 095

MB857553	1 987 476 738
MB857556	1 987 476 737
MB857567	1 987 476 195
MB857572	1 987 476 194
MB857573	1 987 476 501

MB857657	F 01G 09D 00H
MB857755	F 01G 09B OWY
MB857862	F 01G 061 OP3
MB857916	F 01G 09D 00F
MB858614	1 987 481 110

MB858746	F 01G 09B 103
MB858804	F 01G 09B 17V
MB858805	F 01G 09B 17W
MB858949	F 01G 09B OX9
MB863949	F 01G 09E 012

MB895103	F 01G 09B OS7
MB895124	F 01G 09B OZX
MB895126	F 01G 09B OZY
MB895127	F 01G 09B 156
MB895128	F 01G 09B 17Y

MB895528	F 01G 09D 041
MB895815	F 01G 09B 15E
MB895816	F 01G 09B 15F
MB895852	F 01G 09B OY3
MB895944	F 01G 09B 157

MB895963	0 986 480 844
MB895998	F 01G 09B 154
MB920529	F 01G 09E 005
MB928003	0 986 480 733
MB928004	F 01G 09C OYY

MB928066	F 01G 09B 15B
MB928324	F 01G 09C OZC
MB928547	F 01G 09B 102
MB928775	F 01G 09C OZ7
MB928778	F 01G 09B OY1

MB928779	F 01G 09B OY2
MB 928934 V	0 265 006 390
MB950148	0 986 480 737
MB950188	0 986 475 666
MB950308	1 987 476 775

MB950335	1 987 477 676
MB950336	1 987 477 677
MB950343	0 265 006 224
MB950344	0 265 006 223
MB950345	0 265 006 328

MB950346	0 265 006 225
MB950530	F 01G 09B 188
MB950626	1 987 481 111
MB950676	F 01G 09B 15J
MB950748	F 01G 09B ORZ

MB950749	F 01G 09B OS0
MB950752	F 01G 09B 15G
MD710399	0 986 486 517
ME738331	9 421 613 391
MJ805223	F 01G 19C 010

MK326653	F 01G 09C 1EL
MM C4630A009	0 204 024 575
MN102056	F 01G 09D 07C
MN102224	F 01G 09B 1GZ
MN102307	F 01G 09B 1H3

MN102857	0 265 007 637
MN113234	F 01G 09C 1E6
MN116166	0 265 234 316
MN116166	0 265 234 500
MN116320	0 265 231 659

MN116394	F 01G 062 09A
MN116395	F 01G 062 099
MN116396	F 01G 062 09B
MN116462	0 265 007 683
MN116498	1 987 481 010

MN116621	0 204 123 702
MN116622	0 204 123 703
MN 1166231	0 204 125 855
MN116637	0 265 007 674
MN116638	0 265 007 675

MN116639	0 265 007 676
MN116640	0 265 007 677
MN116763	F 01G 09C 12X
MN116919	F 01G 061 0B2
MN116919	F 01G 061 00W

MN163706	0 261 231 187
MN180314	0 261 231 191
MR128203	1 987 482 068
MR128204	1 987 482 069
MR128397	F 01G 09C OZL

MR128669	F 01G 09C 101
MR128670	F 01G 09C 1FN
MR128673	F 01G 09B 1GX
MR128762	F 01G 09C 100
MR128763	F 01G 09C OTW

MR129408	F 01G 09B 15K
MR129504	F 01G 09C 10T
MR129595	0 986 475 948
MR129600	F 01G 09D 024
MR129724	1 987 481 031



MR129742	1 987 481 011
MR129744	1 987 476 502
MR129745	1 987 476 345
MR129749	1 987 481 013
MR129770	1 987 481 010
MR129772	1 987 481 095
MR129773	1 987 476 738
MR129775	1 987 476 965
MR129777	1 987 476 737
MR129778	1 987 476 194
MR129781	1 987 476 501
MR129781	1 987 476 539
MR129787	1 987 476 195
MR129799	1 987 476 784
MR129802	1 987 481 121
MR129844	1 987 481 110
MR129919	1 987 482 062
MR129920	1 987 482 063
MR129948	F 01G 09D 04A
MR129966	0 204 123 200
MR129968	0 204 125 481
MR139771	1 987 476 193
MR141811	F 01G 09E 013
MR164463	F 01G 09C 116
MR173763	F 01G 09E 006
MR173764	F 01G 09E 00E
MR205094	F 01G 09D 046
MR205236	F 01G 09D 047
MR205395	0 265 006 327
MR205396	0 265 006 294
MR205491	1 987 477 862
MR205492	1 987 482 183
MR205509	F 01G 09B 104
MR205510	F 01G 09B 105
MR205556	F 01G 09B 17Z
MR205635	F 01G 09B 15C
MR213339	F 01G 29A 02H
MR235925	F 01G 09C 0UV
MR249429	0 204 123 335
MR249440	F 01G 09B 1B0
MR249541	F 01G 09D 04D
MR249589	F 01G 09E 007
MR249590	F 01G 09E 00L
MR249616	F 01G 09C 1E5
MR249720	0 204 123 198
MR249754	0 265 216 465
MR249789	F 01G 09D 04C
MR289185	F 01G 09C 0W8
MR289188	F 01G 062 0BM
MR289302	F 01G 09D 02C
MR289769	F 01G 09B 17R
MR307142	F 01G 09B 106
MR307144	F 01G 09B 15D
MR307219	0 265 216 046
MR307245	F 01G 09B 23N

MR307429	F 01G 09B 15M
MR307464	0 204 125 527
MR307507	F 01G 09C 0UR
MR307779	F 026 002 566
MR307779	0 204 116 566
MR307809	F 01G 09E 008
MR307929	F 01G 09B 15L
MR334039	0 265 108 034
MR334321	F 01G 09B 22Z
MR334663	F 01G 09E 009
MR334814	F 01G 09C 120
MR334912	F 01G 09D 04Z
MR334939	F 01G 09C 0VF
MR334956	F 01G 09D 054
MR370018	F 01G 09B 1PW
MR370401	F 01G 09C 1E4
MR370408	F 01G 09B 1R3
MR370408	F 01G 061 09D
MR370625	0 265 220 507
MR370641	F 01G 09C 124
MR370642	F 01G 09B 15Y
MR370642	F 01G 061 0AN
MR370715	0 204 021 655
MR370716	0 204 021 666
MR370717	0 204 021 804
MR370758	F 01G 09C 0VA
MR370932	0 265 006 511
MR370933	0 265 006 512
MR389885	F 01G 09B 1N7
MR389951	F 01G 09B 1VS
MR390056	0 204 021 965
MR390057	0 204 021 967
MR407111	F 01G 09C 0WG
MR407357	F 01G 09C 0VP
MR407850	0 204 021 966
MR407870	F 01G 09B 1VZ
MR407871	F 01G 09B 1VY
MR449123	F 01G 09C 126
MR449124	F 01G 09C 125
MR449125	F 01G 09C 127
MR449208	F 01G 09C 0WB
MR449294	0 204 021 835
MR449295	0 204 021 834
MR449367	F 01G 09C 123
MR449655	F 01G 09B 158
MR449656	F 01G 061 0RD
MR449908	F 01G 09B 1VT
MR475014	F 01G 09B 180
MR475014	F 01G 061 0RA
MR475015	F 01G 09B 159
MR475107	F 01G 062 0AD
MR475127	F 01G 061 0RO
MR475128	F 01G 09B 1T1
MR475129	F 01G 061 0R1
MR475135	F 01G 061 0PU

MR475136	F 01G 061 0PT
MR475218	F 01G 09B 1PV
MR 47523	0 265 006 617
MR 475233 V	0 265 006 617
MR 475234 V	0 265 006 618
MR 47524	0 265 006 618
MR475280	0 204 123 335
MR475343	F 01G 09B 1VU
MR475407	F 01G 09C 0WC
MR475506	F 01G 09B 1VV
MR475507	F 01G 09B 1VW
MR475508	F 01G 09B 1VX
MR475509	F 01G 09B 1HO
MR475510	F 01G 09B 1GY
MR475511	F 01G 09B 182
MR475522	F 01G 09B 1SZ
MR475522	F 01G 061 0AP
MR475522K	F 01G 09B 1SX
MR475613	F 01G 09B 15N
MR475614	F 01G 09B 183
MR475615	F 01G 09B 184
MR475695	0 265 216 774
MR475697	0 265 216 776
MR475948	F 01G 09B 1R4
MR475948	F 01G 061 09E
MR493005	F 01G 09B 1PX
MR493006	F 01G 09B 230
MR493200	0 204 021 970
MR493201	0 204 021 971
MR493202	0 204 021 968
MR493203	0 204 021 969
MR493221	F 01G 09B 1H4
MR493555	F 01G 09B 1H6
MR493556	F 01G 09B 1H7
MR493570	F 01G 09B 1H1
MR493629	F 01G 062 0A5
MR493630	F 01G 062 094
MR493851	F 01G 061 0R3
MR493852	F 01G 09B 1W2
MR493852	F 01G 061 0AV
MR493854	F 01G 09B 1W4
MR493854	F 01G 061 0AW
MR510573	1 987 477 864
MR510607	F 01G 062 0AK
MR510608	F 01G 062 0AL
MR510609	F 01G 09C 0WU
MR510610	F 01G 09C 0XL
MR510611	F 01G 061 0PN
MR510612	F 01G 061 0PP
MR527037	F 01G 09B 1W7
MR527038	F 01G 09B 1W8
MR527038	F 01G 061 0B0
MR527055	F 01G 09B 0ZZ
MR527056	F 01G 061 0PA
MR527057	F 01G 09B 189

MR527062	F 01G 09B 15A
MR527129	F 01G 09B 1R5
MR527381	F 01G 061 0PR
MR527616	F 01G 09B 1HC
MR527617	F 01G 061 0PS
MR527618	F 01G 09B 1HE
MR527619	F 01G 09B 1HF
MR527620	F 01G 09B 1W5
MR527629	F 01G 09C 0WT
MR527631	F 01G 09C 0XJ
MR527632	F 01G 062 0AH
MR527633	F 01G 09C 0XK
MR527634	F 01G 062 0AJ
MR569144	F 01G 19C 031
MR569145	F 01G 09B 1HD
MR569146	F 01G 09B 1HB
MR569984	F 01G 09C 12A
MR569988	F 01G 09B 1T0
MR569988	F 01G 061 06S
MR910915	1 987 481 111
MR915063	1 987 482 064
MR915064	1 987 482 065
MR955037	0 265 007 638
MR955352	0 265 005 600
MR955352	0 265 005 687
MR955368	F 01G 09B 1W1
MR955369	F 01G 09B 1W0
MR955768	F 01G 09B 1H8
MR955769	F 01G 09B 1H9
MR955893	F 01G 09B 1H2
MR955897	F 01G 09C 0XA
MR955899	F 01G 09C 0X9
MR955901	F 01G 09C 0XB
MR955929	F 01G 061 0R4
MR955930	F 01G 061 0PB
MR977016	F 01G 09B 1W6
MR977016	F 01G 061 0B1
MR977094	0 265 231 530
MR977097	0 265 234 257
MR977097	0 265 234 316
MR977097	0 265 234 500
MR977153	F 01G 09B 1H5
MR977202	F 01G 061 0R9
MR977252	F 01G 19C 02Z
MR977452	F 01G 09B 1R6
MR977453	F 01G 09B 1R7
MT402260	F 01G 09C 1F5
M862414	1 987 476 775
SMB950399	0 265 216 046
SMR475697	0 265 216 776
S4670A225	0 265 235 099
22611 03333	0 265 108 023
4600A015	0 986 475 956
4625A002	F 01G 062 03G
4625A020	F 01G 09C 12F



◀ MITSUBISHI

4625A021	F 01G 09C 12G
4625A022	F 01G 062 0AG
4625A023	F 01G 09C 12Y
4625A049	F 01G 062 03N
4625A186	F 01G 062 05N

4625A251	F 01G 062 0B9
4625A282	F 01G 062 0BT
4630A004	F 01G 061 07E
4630A005	F 01G 061 07F
4630A006	F 01G 061 06A

4630A024	F 01G 061 04E
4630A025	F 01G 061 04D
4630A034	F 01G 061 07T
4630A035	F 01G 061 07U
4630A047	F 01G 061 0G1

4630A048	F 01G 061 0G2
4635A273	F 01G 260 0CM
530621300	0 265 006 698
8651A026	0 265 005 504

NISSAN

D6010JG00B	0 204 053 214
D6010JG01B	0 204 053 215
D6010JG30B	0 204 053 216

D6010JG31B	0 204 053 217
D60109W52A	F 01G 062 06J
D7210CD70A	F 01G 061 0NE
D7210CF00A	F 01G 061 0NF
D72109H06A	F 01G 061 0MY

D72109H06B	F 01G 061 0R7
D7660 BU700	0 265 231 418
D7660 4U011	0 265 216 790
D7660 4U101	0 265 216 788
D7660 4U102	0 265 216 902

D7660 9X200	0 265 215 527
D7660 9X400	0 265 215 527
D7760 4U012	0 265 216 903
D7760 4U102	0 265 216 902
S96 GD5	0 204 162 045

06105087 1	0 204 102 299
06105 0931	0 204 102 295
06105 0941	0 204 102 296
06105111 1	0 204 102 621
06105113 1	0 204 102 304

06105114 1	0 204 102 305
06601267 1	0 204 131 131
066016110	0 204 131 144
066055710	0 204 131 142
06900 8520	0 204 123 230

06900887 1	0 204 110 624
06900 9351	0 204 123 233
06902 2780	0 204 116 324
06902317 0	0 204 116 569
06902372 0	0 204 116 315

06902564 0	0 204 123 241
06903 0860	0 204 001 359
06905222 1B	0 204 123 231
16300 2781	0 204 163 055
16300 2791	0 204 163 054

16300 2821	0 204 162 047
16300 2830	0 204 162 048
16300 3040	0 204 163 056
16300 3190	0 204 163 057
16756 F3800	1 460 491 300

28400 01100	0 265 108 010
30620 C6100	0 986 486 510
30620 C6400	0 986 486 520
30620 U7000	0 986 486 521
30620 U7001	0 986 486 521

30620 01W01	0 986 486 513
30620 09G10	0 986 486 555
30630VB00A	F 01G 061 0AB
30630VB00B	F 01G 061 0KT
30630VB000	F 01G 09B 0KL

30630VB01A	F 01G 061 0AC
30630VB01B	F 01G 061 0KU
30630-VB05A	F 01G 09B 272
30630WJ000	F 01G 09B 0KP
30630WJ10A	F 01G 061 0KN

30630WJ100	F 01G 09B 0KM
30630WK600	F 01G 061 06U
3063001J00	F 01G 09B 0KK
3063045P00	F 01G 09B 0KN
3063089C60	F 01G 09B 0MN

36400 00QAA	1 987 482 013
36400 00QAB	1 987 477 261
36400 05B10	1 987 477 330
36402 AV910	1 987 477 226
36402 AX000	1 987 477 979

36402 BM600	1 987 477 913
36402 00QAA	1 987 482 012
36402 00QAB	1 987 482 042
36402 01B00	1 987 477 313
36402 2F000	1 987 477 982

36402 4M600	1 987 477 226
36402 4M600	1 987 477 991
36402 50J10	1 987 477 534
36402 70J00	1 987 477 534
36518 00QAA	1 987 482 043

36518 00QAB	1 987 482 145
36518 00QAC	1 987 482 145
36530 AX600	1 987 477 980
36530 AX601	1 987 477 980
36530 BM700	1 987 477 914

36530 BU000	1 987 477 943
36530 0F000	1 987 482 152
36530 0F001	1 987 482 152
36530 0F601	1 987 477 757
36530 0M010	1 987 477 535

36530 0M810	1 987 477 536
36530 0N600	1 987 477 536
36530 0X800	1 987 482 049
36530 0X900	1 987 482 051
36530 00QAC	1 987 477 137

36530 00QAD	1 987 477 137
36530 00QAE	1 987 477 633
36530 01A01	1 987 477 128
36530 1N900	1 987 477 535
36530 2F000	1 987 477 752

36530 2F200	1 987 477 753
36530 4F100	1 987 477 394
36530 4F400	1 987 482 151
36530 50M01	1 987 477 396
36530 50Y10	1 987 477 397

36530 51Y10	1 987 477 398
36530 70J10	1 987 477 399
36530 71J10	1 987 477 754
36530 9F000	1 987 477 755
36530 9F500	1 987 477 231

36530 9F510	1 987 477 755
36531 AX600	1 987 477 992
36531 AX601	1 987 477 992
36531 BM700	1 987 477 915
36531 BU000	1 987 477 944

36531 0F000	1 987 477 756
36531 0F001	1 987 477 756
36531 0F500	1 987 477 981
36531 0F601	1 987 477 757
36531 0M010	1 987 477 537

36531 0M810	1 987 477 538
36531 0N600	1 987 477 538
36531 0X800	1 987 482 048
36531 0X900	1 987 482 050
36531 00QAC	1 987 477 116

36531 00QAD	1 987 477 116
36531 00QAE	1 987 477 632
36531 01A01	1 987 477 127
36531 05B10	1 987 477 106
36531 1N900	1 987 477 537

36531 2F000	1 987 477 758
36531 4F100	1 987 477 400
36531 4F400	1 987 482 150
36531 50M01	1 987 477 402
36531 50Y10	1 987 477 403

36531 51Y10	1 987 477 404
36531 70J10	1 987 477 405
36531 71J10	1 987 477 759
36531 9C003	1 987 477 816
36531 9F000	1 987 477 981

36531 9F510	1 987 477 981
41000 Y9502	0 204 102 294
41000 Y9502	0 204 102 303
41000 Y9600	0 204 102 303
41001 70J00	0 204 102 745

41001 9X225	0 204 001 938
41001 9X525	0 204 205 207
41010 Y9502	0 204 102 302
41010 Y9600	0 204 102 302
41011 70J00	0 204 102 370

41011 9X225	0 204 001 937
41011 9X525	0 204 205 206
41101 G2500	0 986 475 668
4111071600	F 01G 09G 00H
41111 9X425	0 204 102 330

41112 9X425	0 204 102 329
41217 9X225	0 204 201 289
4181060U00	F 01G 29A 037
4183060U00	F 01G 29A 039
44001 00QAB	0 204 004 321

44001 99B02	0 986 472 840
44011 00QAB	0 204 004 320
44011 99B02	0 986 472 839
44100 AX600	0 986 475 933
44100 C7100	0 986 475 893

44100 C7101	0 986 475 893
44100 D0110	0 986 475 560
44100D5522	F 01G 09G 05Z
44100 G5110	0 986 475 675
44100 G9825	0 204 011 273

44100 Q3110	0 986 475 562
44100 U9200	0 986 475 558
44100 0F000	0 986 475 759
44100 0X800	F 026 002 172
44100 0X810	F 026 002 171

44100 0X810	0 204 116 171
44100 0X900	0 204 011 241
44100 01J11	0 986 475 669
44100 04B00	0 986 475 670
44100 04B02	0 986 475 670

44100 08G10	0 986 475 758
44100 13A00	0 986 475 672
44100 13A01	0 986 475 672
44100 13A02	0 986 475 672
44100 17C10	0 986 475 558

44100 3F000	F 026 002 462
44100 3F000	0 204 116 462
44100 3J310	F 026 002 006
44100 3J310	0 204 116 606
44100 37G10	0 986 475 924

44100 37G11	0 986 475 924
44100 5F600	0 986 475 674
44100 50C10	0 986 475 841
44100 50C11	0 986 475 841
44100 50C12	0 986 475 841

44100 50C13	0 986 475 841
44100 51S10	0 986 475 761
44100 51S11	0 986 475 761
44100 55S10	0 986 475 562
44100 55S11	0 986 475 562



44100 6F611	0 986 475 674
44100 7E611	0 986 475 938
44100 7F000	0 986 475 759
44100 7F001	0 986 475 915
44100 70J20	F 026 002 221

44100 70J20	0 204 116 221
44100 70J22	F 026 002 225
44100 70J22	0 204 116 225
44100 9X125	F 026 002 578
44100 99B12	0 986 475 674

44101 3F000	F 026 002 464
44101 3F000	0 204 116 464
44101 3J310	F 026 002 006
44101 3J310	0 204 116 606
44101 70J20	F 026 002 220

44101 70J20	0 204 116 220
44101 70J22	F 026 002 224
44101 70J22	0 204 116 224
44127 9C025	0 204 104 141
44127 90025	0 204 104 141

46007WD965	F 01G 09B 1FG
46010AA020	F 01G 09C 0VK
46010AA320	F 01G 09C 0W0
46010AA520	F 01G 09C 0VL
46010AG010	F 01G 09C 0VY

46010AG300	F 01G 09C 0W6
46010AG810	F 01G 09C 0VZ
46010AH300	F 01G 09C 0WN
46010AH810	F 01G 09C 0X1
46010AH813	F 01G 09C 0XN

46010AJ400	F 01G 09C 0WK
46010AJ410	F 01G 09C 0WY
46010AL500	F 01G 09C 0WS
46010AL501	F 01G 09C 12B
46010AL700	F 01G 09C 0X0

46010AR020	F 01G 062 093
46010AR100	F 01G 09C 0WP
46010AR200	F 01G 09C 0WR
46010AR700	F 01G 09C 0X6
46010AU000	F 01G 09C 0WH

46010AU006	F 01G 09C 12M
46010 AV620	0 204 051 074
46010 AV621	0 204 051 074
46010 AV720	0 204 051 075
46010 AV721	0 204 051 075

46010AW000	F 01G 09C 0X7
46010 AX701	0 986 480 886
46010 BM500	0 204 024 164
46010BM511	F 01G 09C 11U
46010BM512	F 01G 09C 11V

46010 BN300	0 204 024 097
46010 BN500	0 204 024 164
46010 BN800	0 204 024 758
46010 BN810	0 204 024 759
46010 BU000	0 204 024 168

46010 BU800	0 204 024 821
46010 BU810	0 204 024 822
46010B0700	F 01G 09C 0GS
46010B3000	F 01G 09C 0HT
46010B4000	F 01G 09C 0GT

46010B5014	F 01G 09C 1HN
46010B5015	F 01G 09C 1HM
46010B7000	F 01G 09C 1HK
46010CD005	F 01G 062 09D
46010CD400	F 01G 09C 0XE

46010CD405	F 01G 062 09E
46010D0100	F 01G 09C 1JD
46010D3700	F 01G 09C 0NO
46010D3701	F 01G 09C 0N1
46010D4400	F 01G 09C 0MY

46010D4401	F 01G 09C 0MZ
46010D4600	F 01G 09C 0S1
46010D4601	F 01G 09C 0S2
46010D5100	F 01G 09C 0NE
46010D5601	F 01G 09C 0P8

46010D5602	F 01G 09C 0P9
46010D5700	F 01G 09C 0N2
46010D6001	F 01G 09C 0RM
46010E0301	F 01G 09C 0HY
46010FE000	F 01G 09C 0HK

46010FF000	F 01G 09C 0HJ
46010F400B	F 01G 09C 11Y
46010F5200	F 01G 09C 1JU
46010F5600	F 01G 09C 1J5
46010F6600	F 01G 09C 0SD

46010F7000	F 01G 09C 0H2
46010F8000	F 01G 09C 0YM
46010G1500	F 01G 09C 0MP
46010G1601	F 01G 09C 1F2
46010G3200	F 01G 09C 1HX

46010 G9701	0 986 480 926
46010 G9825	0 986 480 928
46010J1800	F 01G 09C 0LM
46010J1801	F 01G 09C 0LN
46010L1101	F 01G 09C 0GX

46010L1410	F 01G 09C 0GZ
46010L7500	F 01G 09C 0HO
46010 MB60A	0 204 051 743
46010 MB60B	0 204 051 742
46010M0802	F 01G 09C 1F1

46010N0100	F 01G 09C 0HV
46010N0110	F 01G 09C 0HW
46010N8200	F 01G 09C 1JF
46010P9100	F 01G 09C 1JH
46010P9400	F 01G 09C 1JG

46010R0104	F 01G 09C 1HE
46010R6001	F 01G 09C 1HT
46010R8060	F 01G 09C 1JS
46010R8200	F 01G 09C 1J7
46010R8270	F 01G 09C 1JT

46010R9061	F 01G 09C 0L7
46010T1000	F 01G 09C 1HJ
46010U0100	F 01G 09C 1GZ
46010U0503	F 01G 09C 1HF
46010U0602	F 01G 09C 1HG

46010U7003	F 01G 09C 1HP
46010 U7701	0 986 480 626
46010VH000	F 01G 09C 0V1
46010VH300	F 01G 09C 11G
46010VH310	F 01G 09C 0WA

46010VK93A	F 01G 062 084
46010VK93B	F 01G 062 085
46010VK93C	F 01G 062 088
46010VK94A	F 01G 062 086
46010VK94B	F 01G 062 087

46010VK94C	F 01G 062 089
46010VP100	F 01G 09C 0VX
46010VU300	F 01G 062 0A2
46010VU301	F 01G 09C 11D
46010VU302	F 01G 09C 0W3

46010VU303	F 01G 062 09C
46010VU500	F 01G 062 0AB
46010VW000	F 01G 062 0A9
46010V0300	F 01G 09C 0KG
46010V0400	F 01G 09C 1J0

46010V1700	F 01G 09C 1JC
46010V2000	F 01G 09C 1JB
46010V6920	F 01G 09C 0M4
46010V7120	F 01G 09C 0M2
46010V7520	F 01G 09C 0M3

46010V7820	F 01G 09C 0MA
46010V7821	F 01G 09C 0MD
46010V8020	F 01G 09C 0ME
46010WA020	F 01G 09C 0VC
46010WA220	F 01G 09C 0VD

46010WD200	F 01G 09C 11E
46010WD300	F 01G 062 0A3
46010WE001	F 01G 09C 128
46010WE500	F 01G 062 0AC
46010WE510	F 01G 062 09F

46010W1300	F 01G 09C 1J2
46010W1400	F 01G 09C 1J4
46010W2200	F 01G 09C 1J3
46010W2400	F 01G 09C 1JA
46010W3000	F 01G 09C 1J9

46010Y0101	F 01G 09C 1HL
46010 Y9507	0 986 480 685
46010 Y9625	0 986 480 686
460100C721	F 01G 09C 0YF
460100E513	F 01G 09C 0Z2

460100E612	F 01G 09C 0YN
460100E712	F 01G 09C 0Z3
460100E911	F 01G 09C 0T3
46010 0F002	0 986 480 952
460100K000	F 01G 09C 0HD

460100K300	F 01G 09C 1EX
460100K400	F 01G 09C 0HC
460100K600	F 01G 09C 0HL
460100M020	F 01G 09C 0ZD
460100M320	F 01G 09C 0TN

460100M620	F 01G 09C 0ZE
460100M822	F 01G 09C 0ZU
460100N620	F 01G 09C 0TS
460100N920	F 01G 09C 105
460100P420	F 01G 09C 0YJ

460100T020	F 01G 062 0A0
46010 0T021	F 01G 09C 1FV
460100V320	F 01G 09C 0V6
460100V520	F 01G 09C 0V5
460100V521	F 01G 09C 0WL

460100W020	F 01G 09C 0TX
460100W022	F 01G 09C 0U7
46010-00QAG	0 986 480 887
46010 00QAH	0 986 480 887
46010-00QAJ	0 986 480 831

46010-00QAK	0 986 480 831
46010-00QAS	0 986 480 828
46010-00QAU	0 986 480 827
4601001A05	F 01G 09C 1FA
4601001F20	F 01G 09C 0LA

4601001F21	F 01G 09C 0LB
4601001G00	F 01G 09C 0M5
4601001N00	F 01G 09C 0NU
4601002U20	F 01G 09C 0RC
4601002W10	F 01G 09C 1J8

4601003B06	F 01G 09C 1FD
4601003N00	F 01G 09C 0NL
4601003R05	F 01G 09C 0KL
4601003U20	F 01G 09C 0RD
46010 04B00	0 986 480 742

4601004B05	F 01G 09C 1M4
46010 04B05	0 986 480 742
4601004F20	F 01G 09C 0LC
4601004H11	F 01G 09C 0H8
4601004R15	F 01G 09C 0LD

4601004U20	F 01G 09C 0SG
4601005N01	F 01G 09C 0R9
4601005U21	F 01G 09C 1FW
4601005U22	F 01G 09C 0TF
4601007N00	F 01G 09C 0NN

4601007N01	F 01G 09C 0YZ
4601007S00	F 01G 09C 1JN
4601008N00	F 01G 09C 0NM
4601009L00	F 01G 09C 1J6
460101A305	F 01G 09C 11F

460101A310	F 01G 09C 0W9
460101E012	F 01G 09C 0T4
460101E210	F 01G 09C 0YD
460101E412	F 01G 09C 0T1
460101K200	F 01G 09C 0HB



◀ NISSAN

460101M220	F 01G 09C 0ZS	460103Y920	F 01G 09C 11H	460105L320	F 01G 09C 0V2	4601063A01	F 01G 09C 0N4
460101M320	F 01G 09C 0TJ	4601030E00	F 01G 09C 0MH	460105M300	0 204 021 667	4601063S20	F 01G 09C 0MJ
460101M320	0 986 480 923	4601030K00	F 01G 09C 0HE	460105M301	0 204 021 668	4601064J63	F 01G 09C 0SH
460101M820	F 01G 09C 0ZT	4601030P10	F 01G 09C 0R5	460105M302	0 204 021 711	4601064J64	F 01G 09C 0SJ
460101N420	F 01G 09C 0UB	4601030P21	F 01G 09C 0SL	460105M303	0 204 021 712	4601064J66	F 01G 09C 0RR
460101P020	F 01G 09C 0YG	4601030R20	F 01G 09C 0PX	460105M322	F 01G 09C 11L	4601064J67	F 01G 09C 0U3
460101P120	F 01G 09C 0SY	4601030R21	F 01G 09C 0PY	460105M323	F 01G 062 0A4	4601064J75	F 01G 09C 0SK
460101P121	F 01G 09C 0TB	4601030W00	F 01G 09C 1JL	460105M422	F 01G 09C 11M	4601065A00	F 01G 09C 0ML
460101P220	F 01G 09C 0YH	4601030001	F 01G 09C 0HP	460105P620	F 01G 09C 0V4	4601065A05	F 01G 09C 0NP
460101P601	F 01G 09C 0TK	4601031E00	F 01G 09C 0MF	460105P720	F 01G 09C 0V3	4601065C10	0 986 480 945
4601010N00	F 01G 09C 0NT	4601031E01	F 01G 09C 0MG	460105U020	F 01G 09C 0W5	4601065C70	F 01G 09C 0YB
4601010601	F 01G 09C 0HR	4601031W00	F 01G 09C 1JR	460105U310	F 01G 09C 0WF	4601065F21	F 01G 09C 0ZN
4601010800	F 01G 09C 0HS	4601032E02	F 01G 09C 0NJ	460105V200	F 01G 09C 0UW	4601065Y73	F 01G 09C 0SP
4601011H11	F 01G 09C 0H5	4601032F20	F 01G 09C 0MS	4601050F20	F 01G 09C 0YA	4601065Y74	F 01G 09C 0SR
4601012E06	F 01G 09C 1GS	4601032R21	F 01G 09C 1FK	4601050L21	F 01G 09C 0LT	4601066A00	F 01G 09C 0MK
4601014H10	F 01G 09C 0H4	4601033E02	F 01G 09C 0NK	4601050R20	F 01G 09C 0U5	4601066A01	F 01G 09C 0NA
4601014602	F 01G 09C 0HU	4601034A05	F 01G 09C 1M5	4601051E21	F 01G 09C 0PF	4601066E00	F 01G 09C 0RV
4601015N00	F 01G 09C 0NS	4601034E02	F 01G 09C 0NH	4601051F20	F 01G 09C 0YC	4601066E05	F 01G 09C 10X
4601015U20	F 01G 09C 0Z8	4601035F21	F 01G 09C 0PA	4601051K00	F 01G 09C 0HA	4601066E06	F 01G 09C 10Y
4601016R05	F 01G 09C 0KM	4601035H10	F 01G 09C 1EW	4601052A00	F 01G 09C 0M9	4601066F21	F 01G 09C 0TL
4601016R15	F 01G 09C 0LJ	4601037N20	F 01G 09C 0XT	4601052A01	F 01G 09C 0N6	4601067A00	F 01G 09C 0MM
4601017V20	F 01G 09C 0PN	4601037R21	F 01G 09C 0RK	4601053A01	F 01G 09C 0N7	4601067U20	F 01G 09C 0TD
4601017V21	F 01G 09C 0Y7	460104H120	F 01G 09C 10B	4601054E21	F 01G 09C 1FH	4601068A00	F 01G 09C 0MN
4601018F20	F 01G 09C 0M6	460104H122	F 01G 09C 0UM	4601054W20	F 01G 09C 1JM	4601069C21	F 01G 09C 0SW
4601018W10	F 01G 09C 1JJ	460104M421	F 01G 062 0AF	4601056A00	F 01G 09C 0MB	4601069E20	F 01G 09C 0RL
460102J020	F 01G 09C 10C	460104N010	F 01G 09C 0W7	4601056L20	F 01G 09C 0LK	4601069F20	F 01G 09C 0TP
460102J120	F 01G 09C 10D	460104N011	F 01G 09C 0X4	4601057Y21	F 01G 09C 0SN	4601069Y20	F 01G 09C 0Y6
460102J220	F 01G 09C 10W	460104N012	F 01G 09C 12S	4601058A01	F 01G 09C 0N8	4601070F21	F 01G 09C 0ZP
460102M124	F 01G 062 0A1	460104P023	F 01G 09C 0UU	4601058E21	F 01G 09C 0S9	4601070J28	0 986 480 695
460102N300	F 01G 09C 0VG	460104P420	F 01G 09C 102	4601058Y22	F 01G 09C 0RP	4601070J85	0 204 123 129
460102N320	F 01G 062 091	460104U020	F 01G 09C 0W4	4601058Y23	F 01G 09C 0SM	4601070N24	F 01G 09C 104
460102S410	F 01G 09C 107	460104U120	0 204 021 759	4601059A01	F 01G 09C 0N9	4601070T20	F 01G 09C 0TC
460102S710	F 01G 09C 0UC	460104U220	0 204 021 760	4601059E10	F 01G 09C 0PZ	4601071A00	F 01G 09C 0MR
460102S711	F 01G 09C 0UY	4601040H00	F 01G 09C 0H7	460106K000	F 01G 09C 0HH	4601071F21	F 01G 09C 0ZR
460102S910	F 01G 09C 108	4601040P10	F 01G 09C 0R4	460106K001	F 01G 09C 0HM	4601072B20	F 01G 09C 0US
4601020N00	F 01G 09C 0PG	4601040Y20	F 01G 09C 0V0	460106M020	F 01G 062 092	4601072B21	F 01G 09C 117
4601021R02	F 01G 09C 1FG	4601041F20	F 01G 09C 0PK	460106M021	F 01G 09C 0W2	4601072F21	F 01G 09C 0TM
4601024U20	F 01G 09C 0TT	4601041H10	F 01G 09C 1EV	460106N000	F 01G 09C 0WJ	4601072Y22	F 01G 09C 0S8
4601025G00	F 01G 09C 0M1	4601041U10	F 01G 09C 0TH	460106N001	F 01G 09C 12K	4601073A00	F 01G 09C 0N3
4601028B23	F 01G 09C 0R1	4601042R20	F 01G 09C 0SC	460106N500	F 01G 09C 0XF	4601074N22	F 01G 09C 0Y5
4601029R02	F 01G 09C 0NG	4601043K00	F 01G 09C 0H9	460106N501	F 01G 09C 12L	4601074R70	F 01G 09C 0Y4
460103C500	F 01G 09C 103	4601044B20	F 01G 09C 0T0	460106P020	F 01G 09C 0U6	4601075T20	F 01G 09C 0Z6
460103E600	F 01G 09C 0ZH	4601044L21	F 01G 09C 0LR	460106P120	F 01G 09C 0UA	4601076N21	F 01G 09C 0S7
460103H020	F 01G 09C 0VR	4601045P20	F 01G 09C 0T2	460106P200	F 01G 09C 0V7	4601076002	F 01G 09C 1GT
460103J121	F 01G 09C 0VE	4601046E21	F 01G 09C 0PL	4601060A00	F 01G 09C 0MC	4601078N21	F 01G 09C 0SS
460103K000	F 01G 09C 0HF	4601046R20	F 01G 09C 0Y8	4601060F21	F 01G 09C 0UT	4601078N22	F 01G 09C 1FP
460103L120	F 01G 09C 0WE	4601046R21	F 01G 09C 0SX	4601060L20	F 01G 09C 0M0	4601078500	F 01G 09C 0HX
460103L121	F 01G 09C 0WZ	4601047E21	F 01G 09C 0PM	4601060Y71	F 01G 09C 1FM	4601079E20	F 01G 09C 0RS
460103L122	F 01G 09C 129	4601047R20	F 01G 09C 0YP	4601061A01	F 01G 09C 0NB	460108H60A	F 01G 062 07L
460103S110	F 01G 09C 10A	4601048A10	F 01G 09C 0RN	4601061000	F 01G 09C 1EY	460108H601	F 01G 09C 12T
460103S410	F 01G 09C 109	4601048W00	F 01G 09C 1JK	4601061502	F 01G 09C 1GW	460108H61A	F 01G 062 07K
460103S460	F 01G 062 0BK	4601049L01	F 01G 09C 0LP	4601062A01	F 01G 09C 0NC	460108H610	F 01G 09C 0WX
460103W420	F 01G 09C 0WM	4601049000	F 01G 09C 1GY	4601062C60	F 01G 09C 0S6	460108H611	F 01G 09C 12U
460103Y62A	F 01G 062 07G	460105K000	F 01G 09C 0HG	4601062J72	F 01G 09C 0SU	460108H90A	F 01G 062 07J
460103Y620	F 01G 09C 0WD	460105K001	F 01G 09C 0HN	4601062Y20	F 01G 09C 0SV	460108H901	F 01G 09C 12V

460108H91A	F 01G 062 07H
460108H911	F 01G 09C 12W
460108L020	F 01G 09C 0W1
460108M102	F 01G 09C 11K
460108M103	F 01G 062 0AA
4601080F20	F 01G 09C 0U8
4601080F21	F 01G 09C 0U9
4601080M00	F 01G 09C 0MV
4601081F20	F 01G 09C 10F
4601081F21	F 01G 09C 10G
4601081F22	F 01G 09C 1FS
46010 81N01	0 986 480 959
4601081T20	F 01G 09C 0Z5
4601082M00	F 01G 09C 0MW
4601082N71	F 01G 09C 0ST
4601082300	F 01G 09C 1GX
4601083M00	F 01G 09C 0MX
4601085E23	F 01G 09C 0RO
4601085E24	F 01G 09C 0RB
4601085E60	F 01G 09C 0YE
4601085F20	F 01G 09C 1FT
4601085001	F 01G 09C 1GU
4601088E21	F 01G 09C 0SB
4601089A00	F 01G 09C 0RA
4601089A01	F 01G 09C 0RB
4601089E00	F 01G 09C 0PV
460109M000	F 01G 09C 114
460109M001	F 01G 09C 1M8
460109M020	F 01G 09C 0V9
460109M121	F 01G 062 0AE
460109W100	F 01G 062 03R
460109W50A	F 01G 09C 131
46010 9X201	0 204 123 609
46010 9X202	0 204 123 610
460109Y001	F 01G 09C 12E
4601091P19	F 01G 09C 0TR
4601091P21	F 01G 09C 0TG
4601091P22	F 01G 09C 0ZJ
4601091P23	F 01G 09C 0ZK
4601091P24	F 01G 09C 0ZV
4601095R20	F 01G 09C 0ZY
46010 99B28	0 986 480 658
46010 99B86	0 986 480 978
46010 99B88	0 986 480 658
46012-JD00A	0 204 054 627
46012-JD01A	0 204 054 629
46012-JD80A	0 204 054 628
46012-JD81A	0 204 054 630
4604864J21	0 204 226 305
46091JG80A	0 204 226 718
46201-00QAC	1 987 481 150
46201-00QAD	1 987 481 151
46201-00QAE	1 987 481 152
46201 00QAF	1 987 476 700
46201 00QOD	1 987 481 152

46201-00QOF	1 987 481 150
46201-00QOG	1 987 481 151
46202 H7025	1 987 476 660
46202 89913	1 987 476 660
46203 C7000	1 987 476 957
46204 89914	1 987 476 657
46204 89919	1 987 476 198
46210 AV720	1 987 476 361
46210 AX601	1 987 476 362
46210 AX606	1 987 476 363
46210 C8000	1 987 476 957
46210 D4001	1 987 476 545
46210 D4002	1 987 476 546
46210 D4011	1 987 476 545
46210 D4012	1 987 476 546
46210 Q9000	1 987 476 545
46210 Q9005	1 987 476 546
46210 0M001	1 987 476 801
46210 0M007	1 987 476 802
46210 0M011	1 987 476 801
46210 0M017	1 987 476 802
46210 0M300	1 987 476 196
46210 0X800	1 987 476 197
46210 01B00	1 987 476 652
46210 01B10	1 987 476 652
46210 04A00	1 987 476 484
46210 04A01	1 987 476 484
46210 04A10	1 987 476 484
46210 06R00	1 987 476 198
46210 06R10	1 987 476 198
46210 2F001	1 987 476 789
46210 2F002	1 987 476 790
46210 2F205	1 987 476 122
46210 2F206	1 987 476 131
46210 28B00	1 987 476 287
46210 28B10	1 987 476 287
46210 4U200	1 987 476 996
46210 4U205	1 987 476 995
46210 40R00	1 987 476 657
46210 40R10	1 987 476 657
46210 5F001	1 987 476 653
46210 5F002	1 987 481 148
46210 5F006	1 987 476 654
46210 5F007	1 987 481 149
46210 5F200	1 987 476 655
46210 5F201	1 987 476 655
46210 5M316	1 987 476 132
46210 5M400	1 987 476 168
46210 5M405	1 987 476 135
46210 50Y02	1 987 476 279
46210 50Y12	1 987 476 279
46210 50Y17	1 987 481 098
46210 60A00	1 987 476 656
46210 60A10	1 987 476 656
46210 60Y10	1 987 481 109

46210 61A00	1 987 476 657
46210 61A10	1 987 476 657
46210 7B000	1 987 481 108
46210 70Y00	1 987 481 109
46210 79916	1 987 476 486
46210 8F800	1 987 476 122
46210 8F801	1 987 476 131
46210 8H300	1 987 476 376
46210 8H305	1 987 476 378
46210 8H510	1 987 476 399
46210 8H515	1 987 476 401
46210 85E00	1 987 476 486
46210 9C007	1 987 481 108
46210 9C008	1 987 481 025
46210 9C015	1 987 481 146
46210 9C501	1 987 481 025
46210 90J00	1 987 476 658
46210 96J00	1 987 476 283
46211 AV710	1 987 476 364
46211 AV715	1 987 476 364
46211 G9801	1 987 476 959
46211 Y9600	1 987 476 958
46211 0F015	1 987 476 903
46211 5M316	1 987 476 133
46211 90J00	1 987 476 659
46212 01A13	1 987 476 660
46212 79913	1 987 476 660
46213 00QAA	1 987 476 914
46213 00QAC	1 987 481 090
46213 01A13	1 987 476 657
46213 01A14	1 987 476 657
46213 79913	1 987 476 657
46213 79914	1 987 476 657
46213 89913	1 987 476 657
46214 AX600	1 987 481 164
46214 Q9015	1 987 476 486
46214 01A11	1 987 476 662
46214 01A14	1 987 476 657
46214 01A16	1 987 476 486
46214 01A17	1 987 476 279
46214 01A19	1 987 476 198
46214 01E00	1 987 476 486
46214 01E01	1 987 476 486
46214 01E10	1 987 476 486
46214 2F001	1 987 476 134
46214 4U000	1 987 476 997
46214 4U010	1 987 476 998
46214 4U011	1 987 476 998
46214 5F000	1 987 476 663
46214 5F001	1 987 476 137
46214 79911	1 987 476 662
46214 79913	1 987 476 657
46214 79914	1 987 476 657
46214 79916	1 987 476 486
46214 79917	1 987 476 279

46214 89911	1 987 476 662
46214 89914	1 987 476 657
46214 89916	1 987 476 486
46214 9U00A	1 987 481 164
46214 90J00	1 987 476 664
46242 00QAA	1 987 476 700
46400 D6401	0 204 031 143
46400 9X200	0 204 031 178
46400 9X50A	0 204 031 178
46402 AX000	1 987 477 979
47210AA300	F 01G 09B 1D3
47210AC000	F 01G 09B 1UD
47210AC425	F 01G 061 019
47210AC500	F 01G 061 0BL
47210AD000	F 01G 09B 1M8
47210AE010	F 01G 09B 1E7
47210AG000	F 01G 09B 1MZ
47210AG010	F 01G 09B 1DY
47210AG900	F 01G 09B 1N2
47210AH100	F 01G 09B 1N3
47210AH300	F 01G 09B 1N0
47210AH310	F 01G 09B 1DX
47210AH500	F 01G 09B 1N1
47210AH510	F 01G 09B 1DW
47210AL500	F 01G 09B 1UA
47210AL500	F 01G 061 0BK
47210AL726	F 01G 09B 1UB
47210AM425	F 01G 09B 1U7
47210AM600	F 01G 09B 1U6
47210AM600	F 01G 061 0BC
47210AM825	F 01G 09B 1UC
47210AM827	F 01G 09B 1D4
47210AM829	F 01G 09B 1D5
47210 AM885	F 01G 09B 1UE
47210AM885	F 01G 061 0EF
47210AN029	F 01G 09B 1A0
47210AN085	F 01G 09B 1A1
47210AR000	F 01G 09B 1CY
47210AR100	F 01G 09B 1CZ
47210AR200	F 01G 061 0PE
47210AR220	F 01G 09B 1D0
47210AS525	F 01G 09B 1D1
47210AS527	F 01G 061 03E
47210AU051	F 01G 09B 1U1
47210AU06A	F 01G 061 0HB
47210AU060	F 01G 09B 1U4
47210AU060	F 01G 061 0BX
47210AU200	F 01G 09B 1U2
47210AU200	F 01G 061 0BV
47210AU201	F 01G 09B 1U3
47210 AV720	0 204 051 162
47210 AV721	0 204 125 835
47210 BM510	0 204 021 858
47210BN300	F 01G 09B 1UK
47210 BN800	0 204 024 760



◀ NISSAN

47210CD025	F 01G 09B 1U8
47210CD027	F 01G 061 0EC
47210CD225	F 01G 09B 1U9
47210CD700	F 01G 09B 1D6
47210CD725	F 01G 09B 1D8

47210CE400	F 01G 09B 1D7
47210CF000	F 01G 061 093
47210CF025	F 01G 061 098
47210CF40A	F 01G 061 0FB
47210CF50J	F 01G 061 0G0

47210CR000	F 01G 09B 1E1
47210CR825	F 01G 09B 1E2
47210CR827	F 01G 09B 1E4
47210CR925	F 01G 09B 1E3
47210CR927	F 01G 09B 1E5

47210C6001	F 01G 09B 0KW
47210C8510	F 01G 09B 0NL
47210DA000	F 01G 09B 19A
47210DA001	F 01G 09B 19B
47210F2701	F 01G 09B 0WG

47210F3900	0 204 024 487
47210F6213	F 01G 09B 13G
47210F6214	F 01G 09B 172
47210F6601	F 01G 09B 23L
47210G3710	F 01G 09B 0PT

47210G5210	F 01G 061 0NX
47210G8110	F 01G 09B 0PV
47210JD00A	0 204 051 551
47210JD90A	0 204 051 552
47210N4310	F 01G 09B 0L1

47210P0103	F 01G 09B 0L0
47210S9110	F 01G 09B 0R8
47210S9910	F 01G 09B 0R7
47210T6000	F 01G 09B 0L2
47210T8100	F 01G 09B 0L3

47210T8601	F 01G 09B 0W4
47210T9300	F 01G 09B 0L5
47210T9310	F 01G 09B 0W5
47210VB001	F 01G 09B 18T
47210VB011	F 01G 09B 18V

47210VB201	F 01G 09B 18W
47210VC000	F 01G 09B 1MM
47210VC010	F 01G 09B 1MU
47210VC011	F 01G 09B 1MN
47210VC012	F 01G 09B 1MS

47210VC013	F 01G 09B 1MR
47210VC100	F 01G 09B 1MV
47210VC101	F 01G 09B 1MP
47210VC102	F 01G 09B 1MT
47210VC103	F 01G 09B 1MW

47210VC200	F 01G 09B 1MX
47210VC300	F 01G 061 0PX
47210VC301	F 01G 09B 1MY
47210VE402	F 01G 09B 1MB
47210VE403	F 01G 09B 1DD

47210VE407	F 01G 09B 1MF
47210VG000	F 01G 09B 1MC
47210VG001	F 01G 09B 1MD
47210VG006	F 01G 09B 1ME
47210VG100	F 01G 09B 1DE

47210VG107	F 01G 09B 1DJ
47210VH001	F 01G 09B 1DB
47210VH003	F 01G 09B 1DC
47210VH004	F 01G 09B 1DG
47210VH100	F 01G 09B 1D9

47210VH101	F 01G 09B 1DA
47210VH300	F 01G 09B 1ML
47210VH310	F 01G 09B 1DF
47210VJ201	F 01G 09B 1EJ
47210VJ202	F 01G 09B 19N

47210VJ205	F 01G 09B 1ER
47210VJ207	F 01G 09B 19X
47210VJ208	F 01G 09B 19Y
47210VK010	F 01G 061 0P8
47210VK105	F 01G 09B 1ES

47210VK106	F 01G 061 0R8
47210VK90A	F 01G 061 0LA
47210VK90B	F 01G 061 0LC
47210VK91A	F 01G 061 0LG
47210VK91B	F 01G 061 0LH

47210VK92A	F 01G 061 0LJ
47210VK92B	F 01G 061 0LP
47210VR400	F 01G 09B 1DV
47210VR401	F 01G 09B 1DU
47210VR402	F 01G 09B 1DZ

47210VR415	F 01G 09B 1E0
47210VS09E	F 01G 061 0F9
47210VS10A	F 01G 061 0G3
47210VS40A	F 01G 061 0LR
47210VS40B	F 01G 061 0LS

47210VS40C	F 01G 061 0LT
47210VS40D	F 01G 061 0LU
47210VS40E	F 01G 061 0LV
47210VS41A	F 01G 061 0LW
47210VU300	F 01G 09B 0Z2

47210VU301	F 01G 09B 1A3
47210VU302	F 01G 09B 1A4
47210VU303	F 01G 09B 0Z3
47210VW200	F 01G 09B 1DH
47210VZ00A	F 01G 061 0NO

47210VZ00B	F 01G 061 0N1
47210V5010	F 01G 09B 0PW
47210V5011	F 01G 09B 0PX
47210V5200	F 01G 09B 0VV
47210V5201	F 01G 09B 0VX

47210V6200	F 01G 09B 0VV
47210V6700	F 01G 09B 0WF
47210WA400	F 01G 09B 19K
47210WA500	F 01G 09B 19L
47210WA501	F 01G 09B 19M

47210WA551	F 01G 061 0P6
47210WC000	F 01G 09B 197
47210WC001	F 01G 09B 198
47210WD100	F 01G 09B 1F2
47210WD105	F 01G 09B 1F5

47210WD165	F 01G 09B 1F6
47210WD205	F 01G 061 0E1
47210WD210	F 01G 09B 1TV
47210WD215	F 01G 09B 1TZ
47210WD216	F 01G 09B 1U0

47210WD400	F 01G 09B 1F3
47210WD925	F 01G 09B 1F4
47210WD929	F 01G 09B 1F7
47210WE005	F 01G 09B 1UP
47210WE500	F 01G 09B 1UR

47210WF705	F 01G 09B 1MA
47210WF750	F 01G 09B 1M9
47210WJ100	F 01G 09B 0WP
47210WJ105	F 01G 09B 0WR
47210WJ505	F 01G 09B 176

47210WJ520	F 01G 09B 175
47210WJ620	F 01G 09B 0WM
47210WJ621	F 01G 09B 0WS
47210WJ900	F 01G 09B 0WL
47210WK600	F 01G 061 070

47210WK700	F 01G 061 071
47210WL025	F 01G 09B 1U5
47210WL525	F 01G 061 0EK
47210WL525	F 01G 061 099
47210W6800	F 01G 09B 0KU

47210Y9625	0 986 485 127
472100C511	F 01G 09B 0T3
472100E711	F 01G 09B 0XL
472100E811	F 01G 09B 0Z4
472100E911	F 01G 09B 13E

472100H000	F 01G 09B 177
472100H501	F 01G 09B 178
472100H901	F 01G 09B 0WK
472100M060	F 01G 09B 0XH
472100M610	F 01G 09B 0XG

472100M800	F 01G 09B 13M
472100N600	F 01G 09B 14C
472100N660	F 01G 09B 14D
472100N661	F 01G 09B 14E
472100N961	F 01G 09B 14F

472100P000	F 01G 09B 16V
472100T001	F 01G 09B 14H
472100T001	F 01G 09B 14J
472100W700	F 01G 09B 17A
472100Y000	F 01G 09B 17C

4721001G01	F 01G 09B 0VT
4721001S10	F 01G 09B 0R6
4721002J02	F 01G 09B 0U4
4721002U10	F 01G 09B 0YV
4721003N02	F 01G 09B 16N

4721003N03	F 01G 09B 16R
4721004C00	F 01G 09B 0VP
4721004U02	F 01G 09B 14M
4721004U03	F 01G 09B 14N
4721005B00	F 01G 09B 0MT

4721005U01	F 01G 09B 0UE
4721005U03	F 01G 09B 0UF
4721005U04	F 01G 09B 1D2
4721006P00	F 01G 09B 0W2
4721008L00	F 01G 09B 23E

4721008U00	F 01G 09B 14L
4721009W01	F 01G 09B 0KZ
472101C211	F 01G 09B 17E
472101F100	F 01G 09B 179
472101M265	F 01G 09B 19F

472101P000	F 01G 09B 16W
472101W300	F 01G 09B 17B
472101W700	F 01G 09B 1ED
472101W710	F 01G 09B 1EC
472101Y000	F 01G 09B 14S

4721010Y01	F 01G 09B 16B
4721011E10	F 01G 09B 0PY
4721014H01	F 01G 09B 0MK
4721014H10	F 01G 09B 0MJ
4721014V01	F 01G 09B 0VY

4721016C00	F 01G 09B 0VR
4721017B00	F 01G 09B 0MU
4721017E00	F 01G 09B 0W0
4721017V00	F 01G 09B 0WH
4721017V01	F 01G 09B 0WJ

4721018W11	F 01G 09B 0KY
472102L700	F 01G 09B 1DL
472102N300	F 01G 09B 19C
472102N360	F 01G 09B 19D
472102N362	F 01G 09B 24G

472102S400	F 01G 09B 0YW
472102S401	F 01G 09B 13Z
472102S405	F 01G 09B 0YY
472102S420	F 01G 09B 19P
472102S421	F 01G 09C 1RP

472102S422	F 01G 09B 19T
472102S424	F 01G 09B 19U
472102S700	F 01G 09B 1EH
472102S705	F 01G 09B 1EL
472102W100	F 01G 09B 1P0

472102W200	F 01G 09B 1P1
472102Y900	F 01G 09B 1DN
4721020N13	F 01G 09B 145
4721022P00	F 01G 09B 0W3
4721023U11	F 01G 09B 14P

4721026E00	F 01G 09B 0W1
4721027C00	F 01G 09B 0T7
4721027N13	F 01G 09B 0PS
4721027N14	F 01G 09B 0VZ
4721028U10	F 01G 09B 14R



472103C400	F 01G 09B 17F
472103C900	F 01G 09B 0WT
472103J102	F 01G 09B 19G
47210 3J400	0 204 125 502
472103L200	F 01G 09B 1EU
472103P500	F 01G 09B 16X
472103S100	F 01G 09B 0YX
472103S105	F 01G 09B 0YZ
47210 3S155	F 01G 09B 27J
472103S300	F 01G 09B 24J
472103S305	F 01G 09B 1EM
472103S310	F 01G 09B 1EF
472103S311	F 01G 09B 1EN
472103S315	F 01G 09B 1EG
472103S316	F 01G 09B 1EP
472103S400	F 01G 09B 16M
472103S860	F 01G 09B 1EK
472103S900	F 01G 09B 19R
472103S901	F 01G 09B 19S
472103S905	F 01G 09B 19V
472103S906	F 01G 09B 19W
472103W410	F 01G 09B 1P2
472103Y61A	F 01G 061 0LE
472103Y610	F 01G 09B 1DM
472103Y800	F 01G 09B 1DP
4721030C10	F 01G 09B 0PU
4721030P05	F 01G 09B 0UA
4721030P06	F 01G 09B 0UB
4721030P07	F 01G 09B 0UC
4721030T01	F 01G 09B 148
4721031G00	F 01G 09B 0VU
4721031U00	F 01G 09B 13H
4721032R01	F 01G 09B 14K
4721032U00	F 01G 09B 16E
4721035F12	F 01G 09B 0R2
4721035F14	F 01G 09B 13U
4721037G01	F 01G 061 0P2
4721037N13	F 01G 09B 16S
4721037Y00	F 01G 09B 13L
4721038F11	F 01G 09B 0R1
4721039W00	F 01G 09B 0VS
472104C000	F 01G 09B 1E6
472104H100	F 01G 09B 141
472104M510	F 01G 061 0PJ
472104M511	F 01G 09B 1UJ
472104M512	F 01G 09B 1UG
472104M513	F 01G 09B 1UH
472104M515	F 01G 09B 1UL
472104M521	F 01G 09B 1TX
472104M564	F 01G 09B 1UN
472104M570	F 01G 061 0PK
472104M761	F 01G 09B 1EZ
472104M762	F 01G 09B 1EB
472104N001	F 01G 09B 1MK
472104N002	F 01G 09B 1E8

472104N011	F 01G 09B 1MH
472104N012	F 01G 09B 1MJ
472104N020	F 01G 09B 1E9
472104P000	F 01G 09B 16Y
472104P600	F 01G 09B 16Z
472104U001	F 01G 09B 1EX
472104U061	F 01G 09B 1FO
47210 4U201	0 204 024 273
47210 4U220	0 204 024 274
472104U000	F 01G 09B 16C
4721040U01	F 01G 09B 1ET
4721040Y00	F 01G 09B 195
4721040Y11	F 01G 09B 1A2
4721040Y60	F 01G 09B 196
4721040Y61	F 01G 09B 1A5
4721041B20	F 01G 09B 0XN
4721041B21	F 01G 09B 0XP
4721041T00	F 01G 09B 0WN
4721042F10	F 01G 09B 0R3
4721042G04	F 01G 09B 16L
4721042G12	F 01G 09B 13Y
4721042G15	F 01G 09B 16K
4721043L10	F 01G 09B 0PR
4721043U00	F 01G 09B 16F
4721044B20	F 01G 09B 0XM
4721044L01	F 01G 09B 0W6
4721045P00	F 01G 09B 0UD
4721046L10	F 01G 09B 0NH
472105C500	F 01G 09B 173
472105C503	F 01G 09B 174
472105M660	F 01G 09B 1UM
472105P600	F 01G 09B 1DT
472105T001	F 01G 09B 199
472105U061	F 01G 09B 1MG
472105V020	F 01G 09B 1M7
472105V220	F 01G 09B 1M6
472105W510	F 01G 09B 1EE
472105Y826	F 01G 09B 1DR
472105Y827	F 01G 09B 1DS
4721050F01	F 01G 09B 13T
4721050R00	F 01G 09B 171
4721050T01	F 01G 09B 0TA
4721051E10	F 01G 09B 0NK
4721051K05	F 01G 09B 0ML
4721052E10	F 01G 09B 0PZ
4721052E12	F 01G 09B 0RO
4721054C00	F 01G 09B 149
4721056F11	F 01G 09B 14T
4721057C00	F 01G 09B 14A
4721057C01	F 01G 09B 14B
4721057Y10	F 01G 09B 0XE
4721058E08	F 01G 09B 0U9
4721058E09	F 01G 09B 13F
4721058Y01	F 01G 09B 129
4721058Y02	F 01G 09B 12B

472106C300	F 01G 09B 0WU
472106P000	F 01G 09B 1CW
472106P100	F 01G 09B 170
472106P101	F 01G 09B 1CX
4721060U02	F 01G 09B 0U5
4721060U03	F 01G 09B 0U6
4721064J13	F 01G 09B 0XD
4721064J20	F 01G 09B 13N
4721064J22	F 01G 09B 13P
4721064J23	F 01G 09B 13S
4721064U00	F 01G 09B 0U8
4721065N00	F 01G 09B 16T
4721065N01	F 01G 09B 146
4721065N02	F 01G 09B 16U
4721065Y11	F 01G 09B 13J
4721065Y12	F 01G 09B 0XF
4721067A10	F 01G 09B 0N1
4721067U02	F 01G 09B 17D
4721068202	F 01G 09B 0KV
4721069F95	F 01G 09B 0Z6
4721069U00	F 01G 09B 0U7
472107C500	F 01G 09B 19J
472107J100	F 01G 09B 1CJ
472107J101	F 01G 061 0P5
4721070F96	F 01G 09B 0Z7
47210 70J85	0 204 125 501
4721070N10	F 01G 09B 0XK
4721070T00	F 01G 09B 147
4721070Y01	F 01G 09B 12A
4721071L11	F 01G 09B 0YU
4721072F95	F 01G 09B 14U
4721072F96	F 01G 09B 14V
4721072Y02	F 01G 09B 13K
4721073L00	F 01G 09B 0T8
4721073L01	F 01G 09B 0T9
4721073L15	F 01G 09B 140
4721074N10	F 01G 09B 0Z1
4721074N11	F 01G 09B 0Z0
4721078N10	F 01G 09B 142
4721078800	F 01G 09B 0KT
472108E101	F 01G 09B 19H
472108E200	F 01G 09B 13B
472108H300	F 01G 09B 1F8
472108H360	F 01G 09B 1FB
472108H710	F 01G 09B 1F9
472108H76A	F 01G 061 0GM
472108H76C	F 01G 061 0LK
472108M110	F 01G 09B 1UF
472108M200	F 01G 09B 1CK
472108M202	F 01G 09B 1CL
472108M260	F 01G 061 0PC
472108M262	F 01G 061 0PD
472108M263	F 01G 09B 1EY
472108V160	F 01G 09B 1A6
4721080E04	F 01G 09B 13C

4721080E05	F 01G 09B 13D
4721080G01	F 01G 09B 13W
4721081F10	F 01G 09B 0Z8
4721081F11	F 01G 09B 14X
4721081T10	F 01G 09B 0Z5
4721082N10	F 01G 09B 143
4721083F10	F 01G 09B 14W
4721084K00	F 01G 09B 0X5
4721085E03	F 01G 09B 16A
4721085F00	F 01G 09B 1CN
47210 9F517	0 204 021 797
47210 9F518	0 204 021 798
47210 9F519	0 204 021 799
47210 9F520	0 204 021 676
47210 9F523	0 204 021 677
472109H025	F 01G 09B 1FA
472109H027	F 01G 09B 1FD
472109H029	F 01G 09B 1FF
472109H062	F 01G 09B 1FE
472109M060	F 01G 09B 19E
472109M070	F 01G 09B 0XJ
47210 9W100	F 01G 09B 2A6
472109W50A	F 01G 061 0GS
472109W52A	F 01G 061 0GT
47210 9X50A	0 204 051 080
47210 9X500	0 204 051 080
472109Y000	F 01G 09B 1EV
472109Y026	F 01G 09B 1EW
4721090N00	F 01G 09B 16P
4721091P15	F 01G 09B 14G
4721092G12	F 01G 09B 16H
4721092G13	F 01G 09B 16J
4721097N00	F 01G 09B 1EA
47240AG020	0 265 005 303
47478 70J85	0 204 120 018
47600AG020	F 01G 09D 0AE
47600AH500	F 01G 09D 0AG
47600AH510	F 01G 09D 0AJ
47600AL700	F 01G 09D 0AK
47600AM400	F 01G 09D 0AR
47600AR100	F 01G 09D 0AH
47600 AU025	0 265 202 517
47600 AU825	0 265 202 519
47600 AV625	0 265 202 525
47600 AV626	0 265 202 507
47600 AV725	0 265 202 525
47600CR900	F 01G 09D 0AT
47600CR901	F 01G 09D 0AU
47600F6503	F 01G 09D 00M
47600F6600	F 01G 09D 010
47600VE400	F 01G 09D 02K
47600VH000	F 01G 09D 02M
47600WC000	F 01G 09D 04W
47600WF000	F 01G 09D 04M
47600WJ100	F 01G 09D 0A3



◀ NISSAN

47600WK500	F 01G 063 00B	4760065E00	F 01G 09D 03V	47660VE865	F 01G 09D 03T	476602W600	F 01G 09D 02Y
47600WK600	F 01G 063 00A	4760065Y00	F 01G 09D 007	47660VJ200	F 01G 09D 035	476602W666	F 01G 09D 077
47600WL000	F 01G 09D 0AS	4760066U00	F 01G 09D 018	47660VK100	F 01G 09D 03K	47660 27000	0 265 215 458
476000L700	F 01G 09D 04E	476007F001	F 01G 09D 02E	47660VK200	F 01G 09D 03L	476603S400	F 01G 09D 030
476000L715	F 01G 09D 04F	476007P10	F 01G 09D 0BA	47660VK300	F 01G 09D 03M	476603S410	F 01G 09D 031
476000M000	F 01G 09D 043	47600 70J25	0 265 201 064	47660VK310	F 01G 09D 03N	476604M401	F 01G 09D 056
476000P000	F 01G 09D 01E	4760070U00	F 01G 09D 01U	47660VK400	F 01G 09D 03P	476604M501	F 01G 09D 05A
476000U000	F 01G 09D 048	47600 71J00	0 265 201 065	47660VW000	F 01G 09D 03G	476604M520	F 01G 09D 05Z
476000W000	F 01G 09D 028	47600 71J25	0 265 201 064	47660VW060	F 01G 09D 079	476604M521	F 01G 09D 06H
476000W010	F 01G 09D 029	4760071L00	F 01G 09D 00V	47660VW300	F 01G 09D 03H	476604M700	F 01G 09D 057
4760001U00	F 01G 09D 00Z	4760072B00	F 01G 09D 04N	47660VW360	F 01G 09D 07A	476604U001	F 01G 09D 05B
4760005U00	F 01G 09D 012	4760078J00	F 01G 09D 01P	47660VX260	F 01G 09D 07D	476604U006	F 01G 09D 073
476001C100	F 01G 09D 01D	4760078J10	F 01G 09D 01R	47660WA001	F 01G 09D 051	47660 4U011	0 265 216 790
476001C120	F 01G 09D 02B	476008H700	F 01G 09D 0AL	47660WA021	F 01G 09D 058	47660 4U101	0 265 216 788
476001C400	F 01G 09D 01N	476008H710	F 01G 09D 0AM	47660WA200	F 01G 09D 052	476605E900	F 01G 09D 06B
476001M200	F 01G 09D 045	476008H720	F 01G 09D 0AV	47660WA401	F 01G 09D 05N	47660 5M326	0 265 216 901
476001P200	F 01G 09D 0AB	4760086E00	F 01G 09D 03U	47660WA501	F 01G 09D 066	47660 5M327	0 265 216 900
476001W300	F 01G 09D 02F	4760086L00	F 01G 09D 013	47660WA600	F 01G 09D 060	476605U001	F 01G 09D 05C
476001W400	F 01G 09D 02G	4760086N00	F 01G 09D 01S	47660WA610	F 01G 09D 061	476605U005	F 01G 09D 06C
4760010Y00	F 01G 09D 086	4760088E00	F 01G 09D 003	47660WA700	F 01G 09D 062	476605U006	F 01G 09D 074
4760010Y00	F 01G 09D 01H	4760091P00	F 01G 09D 01V	47660WA710	F 01G 09D 063	476605V000	F 01G 09D 04X
4760014Y00	F 01G 09D 01J	4760095E00	F 01G 09D 00A	47660WA800	F 01G 09D 06X	476605V200	F 01G 09D 04Y
4760016Y00	F 01G 09D 0AC	4760096E00	F 01G 09D 040	47660WA960	F 01G 09D 09K	476605V210	F 01G 09D 05X
4760017V00	F 01G 09D 00P	4760097N00	F 01G 09D 04K	47660WA961	F 01G 09D 09M	476605V267	F 01G 09D 084
47600 2B000	0 265 206 016	47605 70J01	0 332 205 004	47660WA962	F 01G 09D 09P	476605V500	F 01G 09D 05D
476002L700	F 01G 09D 04R	47660AU066	F 01G 09D 08M	47660WA965	F 01G 09D 09L	476605V510	F 01G 09D 05Y
476002N200	F 01G 09D 04T	47660AU067	F 01G 09D 08N	47660WA966	F 01G 09D 09N	476605V567	F 01G 09D 085
476002N310	F 01G 09D 04V	47660AU068	F 01G 09D 08P	47660WD001	F 01G 09D 05F	476605Y713	F 01G 09D 09B
476002S400	F 01G 09D 02D	47660AU069	F 01G 09D 09C	47660WD011	F 01G 09D 05M	476605Y770	F 01G 09D 088
476003J100	F 01G 09D 04B	47660 AV725	0 265 231 318	47660WD100	F 01G 09D 05H	476606J067	F 01G 09D 07L
476003Y105	F 01G 09D 072	47660 AV726	0 265 231 318	47660WD700	F 01G 09D 065	476606J068	F 01G 09D 090
476003Y166	F 01G 09D 080	47660 AX625	0 265 231 340	47660WD710	F 01G 09D 06K	476606J266	F 01G 09D 07Z
476003Y167	F 01G 09D 08Y	47660 AX625	0 265 231 342	47660WD900	F 01G 09D 06M	476606J268	F 01G 09D 091
4760030P01	F 01G 09D 00X	47660 AX625	0 265 231 842	47660WD905	F 01G 09D 06N	476606J366	F 01G 09D 07M
4760031U10	F 01G 09D 044	47660 AX766	0 265 234 123	47660WD910	F 01G 09D 06P	476606J368	F 01G 09D 092
4760032P00	F 01G 09D 00Y	47660 AX769	0 265 234 154	47660WD915	F 01G 09D 06R	476606J767	F 01G 09D 07N
4760039F00	F 01G 09D 00T	47660 AX770	0 265 234 123	47660WE000	F 01G 09D 06T	476606J768	F 01G 09D 093
476004E100	F 01G 09D 01Y	47660 AX771	0 265 234 154	47660WE010	F 01G 09D 06U	476606N000	F 01G 09D 068
476004H100	F 01G 09D 04G	47660 BA100	0 265 234 147	47660WE100	F 01G 09D 06W	476606N001	F 01G 09D 06D
476004H101	F 01G 09D 04H	47660 BA101	0 265 234 185	47660WE462	F 01G 09D 09T	476606N100	F 01G 09D 069
476004J700	F 01G 09D 04S	47660 BC060	0 265 234 282	47660WE762	F 01G 09D 09U	476606N101	F 01G 09D 06E
476004P200	F 01G 09D 0AD	47660 BC260	0 265 234 284	47660 0X801	0 265 215 458	476606N200	F 01G 09D 06A
4760040Y00	F 01G 09D 04L	47660 BC46A	0 265 234 278	476601BD3B	0 265 236 206	476606N201	F 01G 09D 06F
4760044F00	F 01G 09D 00U	47660 BC460	0 265 234 276	47660 1U66B	0 265 235 044	476606V066	F 01G 09D 08Z
4760048P00	F 01G 09D 01W	47660 BC56A	0 265 234 123	476602U566	F 01G 09D 081	476607J067	F 01G 09D 07U
476005J000	F 01G 09D 04P	47660 BC57A	0 265 234 154	476602U567	F 01G 09D 08V	476607J077	F 01G 09D 07V
476005Y800	F 01G 09D 0AP	47660 BC66A	0 265 231 842	476602U576	F 01G 09D 082	476607J078	F 01G 09D 094
4760050P00	F 01G 09D 01X	47660 BN725	0 265 231 428	476602U577	F 01G 09D 08W	47660 8F000	0 265 215 437
4760055Y00	F 01G 09D 005	47660 BN827	0 265 231 416	476602U666	F 01G 09D 083	47660 8F005	0 265 215 437
4760058E00	F 01G 09D 000	47660VB000	F 01G 09D 02R	476602U667	F 01G 09D 08X	47660 8F800	0 265 216 587
476006C500	F 01G 09D 02H	47660VC200	F 01G 09D 03J	476602W100	F 01G 09D 02W	47660 8F816	0 265 216 587
4760060U01	F 01G 09D 017	47660VC300	F 01G 09D 03R	476602W166	F 01G 09D 075	47660 8F825	0 265 216 587
4760061U00	F 01G 09D 011	47660VE702	F 01G 09D 02T	476602W500	F 01G 09D 02X	47660 8F826	0 265 216 587
4760062J00	F 01G 09D 03W	47660VE704	F 01G 09D 02U	476602W566	F 01G 09D 076	476608M100	F 01G 09D 05R
4760064J00	F 01G 09D 004	47660VE860	F 01G 09D 03S	476602W567	F 01G 09D 078	476608M101	F 01G 09D 06G

476608M110	F 01G 09D 064
476608M111	F 01G 09D 06J
476608N500	F 01G 09D 06Y
47660 9F626	0 265 216 689
47660 9F629	0 265 216 898
47660 9K16B	0 265 231 733
47660 9U06B	0 265 235 046
47660 9U16B	0 265 231 733
47660 9U26B	0 265 235 048
47660 9X425	0 265 215 527
47660 9Z540	0 265 215 527
47850 AU300	0 265 109 620
47850 AU310	0 265 109 621
47850 AU600	0 265 109 622
47850 AV400	0 265 109 604
47850 AV401	0 265 109 605
47850 AV402	0 265 109 605
47850 AV403	0 265 109 604
47850 AV404	0 265 109 604
47850 BV000	0 265 109 624
47850 BV001	0 265 109 750
47850 BV010	0 265 109 623
478500C710	F 01G 09E 00D
478500E020	F 01G 09E 00R
47850 0M000	0 265 108 010
478500P020	F 01G 09E 003
478501C120	F 01G 09E 00Y
47850 1U100	0 265 108 024
4785010Y00	F 01G 09E 001
47850 2F610	0 265 108 036
478502P000	F 01G 09E 00A
478502S700	F 01G 09E 010
478503H020	F 01G 09E 018
47850 4B000	0 265 108 010
4785048P00	F 01G 09E 00B
478505C500	F 01G 09E 00V
478505C520	F 01G 09E 00Z
4785050P00	F 01G 09E 00C
47850 6F600	0 265 108 041
47850 6F610	0 265 108 036
4785065Y00	F 01G 09E 02Y
4785066U00	0 265 106 021
4785068U11	F 01G 09E 016
47850 7F000	0 265 100 054
47850 7F002	0 265 108 040
47850 7QJ01	0 265 100 054
4785075E00	F 01G 09E 02Z
4785075N00	F 01G 09E 00U
4785078J00	F 01G 09E 00M
4785079J00	F 01G 09E 00N
4785079J10	F 01G 09E 00T
47850 8B700	0 265 108 042
478508H717	0 265 109 741
478508H812	F 01G 09E 02P
4785086N00	F 01G 09E 00P

4785091P00	F 01G 09E 002
47900 AV700	0 265 007 466
47900 AV710	0 265 007 633
47900 AX600	0 265 007 539
47900 BM500	0 265 006 794
47900 BN800	0 265 007 554
47900 BN805	0 265 007 554
47900 BU800	0 265 007 558
47900 BU805	0 265 007 558
47900 JD000	0 265 007 908
47900 JD600	0 265 007 909
47900 NB805	0 265 007 554
47900 0X800	0 265 006 778
47900 0X900	0 265 006 779
47900 1U200	0 265 006 256
47900 2F000	0 265 006 378
47900 2F001	0 265 006 378
47900 3F001	0 265 006 378
47900 3J310	0 265 006 236
47900 5F600	0 265 006 256
47900 6F005	0 265 006 382
47900 6F605	0 265 006 382
47900 7F000	0 265 006 281
47900 7F200	0 265 006 285
47900 7Z310	0 265 006 607
47900 7QJ00	0 265 001 275
47900 71J00	0 265 001 314
47900 8J000	0 265 007 415
47900 8J002	0 265 007 763
47900 9F500	0 265 006 709
47900 9X200	0 265 006 718
47900 9X201	0 265 006 719
47900 9X400	0 265 006 716
47900 9X401	0 265 006 717
47900 9X500	0 265 006 819
47900 9X501	0 265 006 820
47901 AV700	0 265 007 465
47901 AV710	0 265 007 632
47901 AX600	0 265 007 538
47901 AX610	0 265 007 538
47901 BM500	0 265 006 795
47901 BN800	0 265 007 555
47901 BN805	0 265 007 555
47901 BU800	0 265 007 559
47901 BU805	0 265 007 559
47901 2F000	0 265 006 379
47901 2F001	0 265 006 379
47901 3J310	0 265 006 237
47901 7QJ00	0 265 001 276
47901 71J00	0 265 001 315
47901 8J000	0 265 007 416
47901 8J002	0 265 007 762
47901 9F500	0 265 006 708
47910 AV700	0 265 007 464
47910 AX600	0 265 007 537

47910 AX610	0 265 007 537
47910 BM400	0 265 006 703
47910 BN800	0 265 007 552
47910 BU800	0 265 007 556
47910 JD000	0 265 007 905
47910 0X800	0 265 006 755
47910 1F510	0 265 006 715
47910 1U200	0 265 006 254
47910 3J300	0 265 006 232
47910 3J301	0 265 006 232
47910 5F600	0 265 006 254
47910 5M300	0 265 006 606
47910 7B700	0 265 006 608
47910 7F000	0 265 001 413
47910 7F000	0 265 006 671
47910 7F001	0 265 006 671
47910 7QJ00	0 265 001 273
47910 71J00	0 265 001 312
47910 8J000	0 265 007 413
47911 AV700	0 265 007 463
47911 BM400	0 265 006 702
47911 BN800	0 265 007 553
47911 BU000	0 265 006 704
47911 BU800	0 265 007 557
47911 0L732	0 265 006 524
47911 0M032	0 265 006 449
47911 0X800	0 265 006 756
47911 1F500	0 265 006 658
47911 1F510	0 265 006 714
47911 1U200	0 265 006 255
47911 3J300	0 265 006 233
47911 3J301	0 265 006 233
47911 5F600	0 265 006 255
47911 5M300	0 265 006 605
47911 7B710	0 265 006 536
47911 7F000	0 265 001 414
47911 7F000	0 265 006 670
47911 7F001	0 265 006 670
47911 7QJ00	0 265 001 274
47911 71J00	0 265 001 313
47911 8J000	0 265 007 414
47930 AV400	0 265 005 265
47930 AX700	0 265 005 263
47930 7QJ00	0 265 005 019
47931 BC40A	0 265 005 265
47931 1EA1A	0 265 005 806
82005 83498	0 265 008 077
82006 752748	0 265 008 041
82006 75755	0 265 008 042
82007 24127	0 265 008 078
OPEL	
GR 4 665	0 204 204 711
GR 4 665	0 204 204 712
GR 4 667	0 204 104 298

GR 5 043	0 204 104 299
02866166	0 986 475 216
03476450	0 986 480 485
03476987	0 986 480 495
03487377	0 986 472 467
03488126	0 986 480 095
03488318	0 986 480 496
03488432	0 986 480 494
03488710	0 986 480 496
03488711	0 986 480 113
03488812	0 986 480 495
03488813	0 986 480 494
03492175	0 986 480 118
03492538	0 986 480 116
03492539	0 986 480 128
0530174	0 265 234 683
0558145	0 204 123 659
0558182	0 204 123 664
08967747	0 986 475 448
08967751	0 986 475 019
09120538	0 265 220 430
09127787	1 987 477 668
09195563	0 204 031 174
09199636	0 265 005 435
10235670	0 986 480 942
10403283	1 987 477 761
10405685	1 987 477 762
10415656	0 265 005 411
1236310	0 265 005 434
1237307	0 265 103 034
1237327	0 265 100 039
1237333	0 265 103 038
1238236	0 986 594 027
1238246	0 265 005 435
1238247	0 265 005 262
1238345	0 261 231 006
1238410	0 265 003 050
1238410	0 265 006 488
1238411	0 265 001 236
1238412	0 265 001 235
1238413	0 265 001 238
1238414	0 265 001 237
1238424	0 986 594 026
1238629	0 332 205 004
1238917	0 986 594 025
1238918	0 986 594 028
1238985	0 265 003 094
1238986	0 265 003 093
1238987	0 265 006 487
1238988	0 265 006 486
1238998	0 265 006 488
12566845	0 261 231 174
12618603	0 261 231 174
13104993	1 987 482 107
13106484	1 987 477 763



◀ OPEL

13106485	1 987 477 907	24407651	1 987 477 907	3492930	0 986 480 132	5 22 537	1 987 477 031
13116133	1 987 481 161	24420696	0 261 231 173	3492954	0 986 480 818	5 22 544	1 987 477 030
13116134	1 987 481 162	24425108	1 987 477 527	3495064	0 986 480 859	5 22 545	1 987 477 049
13116136	1 987 476 199	24425112	1 987 477 528	3495542	0 986 480 684	5 22 548	1 987 477 131
13116137	1 987 476 200	24427061	1 987 477 391	3495649	0 986 480 010	5 22 549	1 987 477 132
13131296	1 987 476 394	24428295	0 265 005 433	3525994	0 265 001 241	5 22 552	1 987 477 241
13136715	1 987 476 455	24430462	0 265 005 434	3542471	0 265 206 014	5 22 554	1 987 477 031
13138929	1 987 482 140	24436451	1 987 477 764	4363738	0 265 001 159	5 22 558	1 987 477 868
13138930	1 987 482 139	24436467	1 987 477 765	4403219	0 204 102 052	5 22 559	1 987 477 135
13153656	1 987 482 141	24436541	1 987 476 386	4403220	0 204 102 054	5 22 560	1 987 477 138
13157061	1 987 477 908	24436542	1 987 476 365	4403490	1 987 477 261	5 22 561	1 987 477 138
13157062	1 987 477 909	24443834	1 987 477 529	4405655	1 987 476 432	5 22 562	1 987 477 246
13157063	1 987 477 934	24455114	1 987 477 763	4408726	1 987 482 042	5 22 568	1 987 477 136
13157064	1 987 477 163	24465148	1 987 482 102	4408734	1 987 477 116	5 22 569	1 987 477 140
13159021	1 987 477 935	24465149	1 987 482 107	4408735	1 987 482 043	5 22 570	1 987 477 243
13162335	1 987 477 907	24468130	1 987 477 869	4413094	0 986 480 827	5 22 571	1 987 477 133
13162336	1 987 477 907	25720865	0 265 202 488	4414014	0 986 480 887	5 22 572	1 987 477 134
13162337	1 987 477 907	25720866	0 265 220 615	4414019	0 986 480 831	5 22 573	1 987 477 247
13172730	1 987 482 138	3476978	0 986 480 117	4415502	0 986 480 828	5 22 578	1 987 477 250
13194247	1 987 476 455	3476981	0 986 485 006	4701124	1 987 476 908	5 22 579	1 987 477 253
13214177	1 987 482 039	3487152	1 987 470 496	4703055	0 204 123 540	5 22 580	1 987 477 253
13214178	1 987 482 038	3487155	0 986 471 465	4706576	0 204 204 711	5 22 585	1 987 477 130
13214179	1 987 482 037	3487156	0 986 472 465	4706577	0 204 204 712	5 22 587	1 987 477 133
13220099	1 987 477 909	3487163	0 986 471 461	4706688	1 987 482 136	5 22 588	1 987 477 141
13220101	1 987 477 908	3487164	0 986 472 461	4706689	1 987 482 137	5 22 589	1 987 477 142
13221030	0 265 005 656	3487290	0 986 472 463	4706753	0 204 104 298	5 22 590	1 987 477 140
13237271	1 987 477 909	3487291	0 986 471 463	4706754	0 204 104 299	5 22 592	1 987 477 250
13237272	1 987 477 934	3487331	0 986 471 462	4708604	0 204 011 407	5 22 593	1 987 477 308
13237273	1 987 477 908	3487332	0 986 472 462	4709779	0 204 054 366	5 22 594	1 987 477 307
13237275	1 987 477 163	3487356	0 986 471 464	4709780	0 204 054 376	5 22 595	1 987 477 130
13251588	1 987 481 017	3487376	0 986 471 467	4709783	0 204 051 327	5 22 597	1 987 477 140
13255755	1 987 482 198	3487378	0 986 471 002	4709784	0 204 054 382	5 22 599	1 987 477 142
13277813	0 265 230 288	3487380	0 986 471 462	5 22 002	1 987 477 528	5 22 600	1 987 477 258
1605109	1 987 472 043	3487381	0 986 472 462	5 22 004	1 987 477 528	5 22 601	1 987 477 140
1605111	1 987 472 043	3487987	0 986 471 004	522007	1 987 482 102	5 22 602	1 987 477 141
1605141	1 987 470 020	3487988	0 986 472 004	522008	1 987 482 107	5 22 603	1 987 477 129
1605161	1 987 472 073	3487989	0 986 471 005	522014	1 987 482 139	5 22 614	1 987 477 310
1605161	1 987 472 294	3487990	0 986 472 005	522015	1 987 482 140	5 22 615	1 987 477 309
1605216	1 987 470 020	3487991	0 986 471 003	522017	1 987 482 138	5 22 620	1 987 477 141
1605226	1 987 472 043	3487992	0 986 472 003	522038	1 987 482 039	5 22 621	1 987 477 143
1605227	1 987 472 041	3488049	0 986 485 006	522039	1 987 482 038	5 22 640	1 987 477 258
1605330	1 987 472 041	3488319	0 986 480 483	522040	1 987 482 037	5 22 641	1 987 477 129
1605434	1 987 472 043	3488531	0 986 485 056	522042	1 987 482 198	5 22 642	1 987 477 310
1605438	1 987 472 264	3488857	0 986 480 095	5 22 150	1 987 477 869	5 22 643	1 987 477 309
1605464	1 987 470 496	3488959	0 986 480 095	5 22 275	1 987 477 250	5 22 650	1 987 477 668
1605505	1 987 472 041	3488960	0 986 480 093	522424	1 987 482 170	5 30 103	0 265 200 041
1605522	1 987 472 043	3492168	0 986 480 616	522425	1 987 482 171	5 30 105	0 265 201 048
1605523	1 987 472 043	3492289	0 986 480 616	522426	1 987 482 110	5 30 108	0 265 206 003
1605579	1 987 472 261	3492300	0 986 485 009	522427	1 987 482 111	5 30 111	0 265 208 311
17999810	1 987 476 084	3492307	0 986 485 007	5 22 445	1 987 477 667	5 30 177	0 265 230 288
18044060	0 986 475 869	3492361	0 986 480 114	522454	1 987 482 141	5 30 178	0 265 232 239
19121235	0 265 219 503	3492362	0 986 480 115	5 22 525	1 987 477 025	5 30 179	0 265 230 286
24404062	1 987 477 250	3492467	0 986 480 130	522528	1 987 482 102	5 30 400	0 265 001 056
24407363	0 986 475 029	3492616	0 986 480 131	522529	1 987 482 107	5 30 401	0 265 001 055
24407364	0 986 475 032	3492913	0 986 480 129	5 22 532	1 987 477 766	5 30 403	0 265 001 143

5 30 404	0 265 001 144	5 42 216	0 986 472 462	5 44 119	0 986 485 125	5530115	0 265 220 637
5 30 405	0 265 001 147	5 42 217	0 986 471 764	5 44 122	0 986 485 007	5530117	0 265 202 513
5 30 406	0 265 001 145	5 42 218	0 986 471 765	5 44 139	0 986 485 125	5530119	0 265 202 509
5 30 408	0 265 001 220	5 42 221	0 986 471 004	5 44 140	0 986 485 109	5530120	0 265 202 503
5 30 433	0 265 001 134	5 42 222	0 986 472 004	5 50 006	0 986 475 029	5530121	0 265 231 307
5 30 436	0 265 001 206	5 42 223	0 986 471 005	5 50 011	0 986 475 869	5530122	0 265 234 051
5 30 437	0 265 001 226	5 42 224	0 986 472 005	5 50 012	0 986 475 216	5530123	0 265 231 444
5 30 439	0 265 001 207	5 42 225	0 986 471 003	5 50 040	0 986 475 448	5530139	0 265 231 584
5 30 440	0 265 001 208	5 42 226	0 986 472 003	5 50 055	0 986 475 452	5530141	0 265 231 586
5 30 442	0 265 001 232	5 42 229	0 986 471 947	5 50 056	0 986 475 448	5530143	0 265 234 094
5 30 491	0 265 001 233	5 42 230	0 986 471 948	5 50 057	0 986 475 020	5530144	0 265 234 340
5 30 600	0 265 103 055	5 42 231	0 986 471 905	5 50 058	0 986 475 021	5530145	0 265 234 324
5 30 603	0 265 100 033	5 42 232	0 986 471 906	5 50 064	0 986 475 019	5530155	0 265 231 538
5 30 604	0 265 103 016	5 42 233	0 986 471 913	5 50 065	0 986 475 451	5530156	0 265 231 844
5 30 605	0 265 103 016	5 42 234	0 986 471 914	5 50 066	0 986 475 019	5530157	0 265 230 286
5 32 530	1 987 477 026	5 42 241	0 986 471 901	5 50 113	0 986 475 453	5530157	0 265 235 164
5 42 019	0 986 471 650	5 42 242	0 986 471 902	5 50 114	F 026 002 123	5530158	0 265 230 288
5 42 041	0 986 472 704	5 42 243	0 986 471 899	5 50 114	0 204 116 123	5530158	0 265 235 060
5 42 042	0 986 471 704	5 42 244	0 986 471 900	5 50 114	0 986 475 450	5530165	0 265 234 697
5 42 061	0 986 471 461	5 42 245	0 986 471 895	5 50 115	0 986 475 451	5530166	0 265 234 695
5 42 062	0 986 472 461	5 42 246	0 986 471 896	5 50 115	0 986 475 777	55352183	0 261 231 181
5 42 069	0 986 471 466	5 42 250	0 986 471 906	5 50 118	0 986 475 588	5544002	0 204 125 812
5 42 070	0 986 472 466	5 42 251	0 986 471 905	5 50 119	0 986 475 453	5544003	0 204 125 813
5 42 073	0 986 471 463	5 42 253	0 986 471 945	5 50 120	F 026 002 123	5544006	0 204 125 827
5 42 074	0 986 472 463	5 42 254	0 986 471 946	5 50 120	0 204 116 123	5562079	1 987 476 201
5 42 075	0 986 471 889	5 42 255	0 986 471 957	5 50 121	0 986 475 021	5562203	1 987 476 386
5 42 076	0 986 471 890	5 42 256	0 986 471 958	5 50 122	0 986 475 019	5562204	1 987 476 365
5 42 077	0 986 471 756	5 42 259	0 986 471 943	5 50 123	0 986 475 019	5562245	1 987 476 394
5 42 078	0 986 471 757	5 42 260	0 986 471 944	5 50 124	0 986 475 021	5562247	1 987 476 199
5 42 079	0 986 471 462	5 42 261	0 986 471 949	5 50 125	0 986 475 020	5562260	1 987 476 455
5 42 080	0 986 472 462	5 42 262	0 986 471 950	5 50 127	0 986 475 588	5 56 248	1 987 476 200
5 42 081	0 986 471 464	5 42 269	0 986 471 913	5 50 128	0 986 475 453	55700425	0 265 007 671
5 42 082	0 986 472 464	5 42 270	0 986 471 914	5 50 129	F 026 002 123	55700426	0 265 007 769
5 42 083	0 986 471 892	5 42 276	0 986 471 017	5 50 129	0 204 116 123	55700975	1 987 476 454
5 42 084	0 986 471 891	5 42 300	0 204 102 959	5 50 130	0 986 475 029	55701047	1 987 476 451
5 42 097	0 986 471 903	5 42 301	0 204 102 960	5 50 131	0 986 475 045	55701387	0 265 007 768
5 42 098	0 986 471 904	5 42 313	0 986 471 017	5 50 132	0 986 475 031	55702812	0 265 005 657
5 42 101	0 986 471 820	5 42 450	0 986 471 820	5 50 133	0 986 475 143	5 58 001	0 986 480 496
5 42 102	0 986 471 821	5 42 451	0 986 471 821	5 50 134	0 986 475 022	5 58 002	0 986 480 483
5 42 139	0 986 471 650	5 42 542	0 204 902 030	5 50 135	0 986 475 032	5 58 003	0 986 480 128
5 42 141	0 986 471 650	5 42 543	0 204 902 031	5 50 140	0 986 475 032	5 58 004	0 986 480 116
5 42 145	0 986 471 650	5 42 544	0 204 902 032	5 50 141	0 986 475 143	5 58 006	0 986 480 493
5 42 148	0 986 472 704	5 42 544	0 204 902 119	5 50 142	0 986 475 807	5 58 009	0 986 480 818
5 42 202	0 986 471 704	5 42 545	0 204 902 033	5 50 143	0 986 475 032	5 58 013	0 986 480 684
5 42 203	0 986 471 465	5 42 545	0 204 902 120	5 50 144	0 986 475 143	5 58 017	0 986 480 065
5 42 204	0 986 472 465	5 44 006	0 986 485 133	5 50 153	0 986 475 143	5 58 019	0 986 480 129
5 42 207	0 986 471 465	5 44 070	0 986 485 037	5 50 157	0 986 475 869	5 58 020	0 986 480 010
5 42 208	0 986 472 465	5 44 073	0 986 485 038	55182636	0 261 231 174	5 58 021	0 986 480 134
5 42 209	0 986 471 461	5 44 085	0 986 485 096	55182640	0 261 231 174	5 58 025	0 986 480 133
5 42 210	0 986 472 461	5 44 095	0 986 485 056	5530104	0 265 202 458	5 58 029	0 986 480 846
5 42 211	0 986 471 467	5 44 106	0 986 485 038	5530106	0 265 202 480	5 58 032	0 986 480 088
5 42 212	0 986 472 467	5 44 107	0 986 485 006	5530106	0 265 202 492	5 58 034	0 986 480 095
5 42 213	0 986 471 002	5 44 108	0 986 485 004	5530107	0 265 005 303	5 58 035	0 986 480 616
5 42 214	0 986 472 002	5 44 111	0 986 485 100	5530107	0 265 220 659	5 58 036	0 986 480 093
5 42 215	0 986 471 462	5 44 117	0 986 485 009	5530114	0 265 202 492	5 58 038	0 986 480 094



◀ OPEL

5 58 040	0 986 480 095	5 58 185	0 986 480 495	88960667	F 00H W00 000	90167539	0 986 475 019
5 58 043	0 986 480 756	5 58 186	0 986 480 494	8965688	0 986 475 451	90167540	0 986 475 021
5 58 044	0 986 480 750	5 58 187	0 204 123 637	8967749	0 986 475 020	90167545	0 986 475 020
5 58 045	0 986 480 751	5 58 187	0 986 480 064	8967752	0 986 475 021	90168040	0 986 475 453
5 58 048	0 986 480 892	5 58 191	0 986 480 010	90000425	1 987 477 026	90168041	F 026 002 123
5 58 050	0 986 480 065	5 58 192	0 986 480 764	90006691	0 986 480 063	90168041	0 204 116 123
5 58 052	0 986 480 616	5 58 194	0 986 480 496	90006694	0 204 123 637	90168396	0 986 475 453
5 58 055	0 986 480 063	5 58 195	0 986 480 113	90006694	0 986 480 064	90168898	1 987 476 405
5 58 056	0 204 123 637	5 58 198	0 986 480 765	90006861	0 204 123 637	90170750	1 987 477 241
5 58 056	0 986 480 064	5 62 037	1 987 476 690	90006861	0 986 480 064	90184270	1 987 477 135
5 58 057	0 986 480 616	5 62 094	1 987 476 030	90006865	0 986 480 010	90184271	1 987 477 138
5 58 058	0 986 480 752	5 62 095	1 987 476 691	90007425	0 986 475 029	90 187 567	0 986 475 453
5 58 062	0 986 480 485	5 62 301	1 987 476 011	90007426	0 986 475 045	90187568	F 026 002 123
5 58 062	0 986 480 569	5 62 304	1 987 476 911	90008235	1 987 476 405	90187568	0 204 116 123
5 58 070	0 986 480 493	5 62 306	1 987 476 013	90009092	0 986 471 467	90189473	0 986 475 588
5 58 071	0 986 480 118	5 62 309	1 987 476 014	90009093	0 986 472 467	90189474	0 986 475 019
5 58 074	0 986 480 615	5 62 314	1 987 476 017	90009298	0 986 480 765	90189718	1 987 477 243
5 58 078	0 986 480 859	5 62 315	1 987 476 692	90009593	0 986 475 022	90193357	1 987 477 138
5 58 082	0 986 480 892	5 62 318	1 987 476 440	90009594	0 986 475 143	90193363	1 987 477 031
558092	0 986 480 858	5 62 320	1 987 476 412	90010524	1 987 476 426	90199759	1 987 476 020
558093	0 986 480 993	5 62 325	1 987 476 408	90019741	0 986 471 650	90209242	0 986 475 029
5 58 095	0 986 480 756	5 62 328	1 987 476 405	90042050	0 265 003 050	90210450	0 265 001 144
5 58 097	0 986 480 032	5 62 331	1 987 476 020	90042050	0 265 006 488	90210495	0 265 001 147
5 58 099	0 986 480 907	5 62 336	1 987 476 409	90042576	0 265 103 038	90213477	0 265 001 143
5 58 100	0 986 480 114	5 62 341	1 987 476 693	90062407	0 265 001 055	90216275	1 987 476 409
5 58 101	0 986 480 115	5 62 343	1 987 476 426	90062408	0 265 001 056	90216441	1 987 477 247
5 58 102	0 986 480 130	5 62 345	1 987 476 464	90077695	1 987 476 011	90217234	1 987 477 246
5 58 105	0 986 480 758	5 62 346	1 987 476 030	90077917	1 987 476 013	90217297	1 987 476 693
5 58 107	0 986 480 131	5 62 350	1 987 476 464	90079277	1 987 476 014	90222437	1 987 477 250
5 58 114	0 986 480 032	5 62 352	1 987 476 564	90079377	1 987 476 017	90223572	1 987 477 134
5 58 119	0 986 480 132	5 62 353	1 987 476 694	90079571	1 987 476 692	90235419	0 986 475 022
5 58 120	0 986 480 764	5 62 358	1 987 476 464	90079577	1 987 476 014	90235420	0 986 475 032
558120	0 986 480 884	5 62 359	1 987 476 564	90090964	1 987 476 440	90235422	0 986 475 143
558121	0 986 480 885	562363	1 987 481 147	90094413	0 986 472 704	90235567	1 987 476 426
5 58 128	0 204 123 637	5 62 364	1 987 476 644	90094414	0 986 471 704	90235568	1 987 476 464
5 58 128	0 986 480 064	5 62 447	1 987 476 038	90094673	0 986 475 451	90235948	1 987 477 136
5 58 131	0 204 123 638	5679301	0 986 486 036	90094929	0 986 471 465	90235999	1 987 476 030
5 58 132	0 986 480 764	5679307	0 986 486 063	90094930	0 986 472 465	90271037	0 986 480 065
5 58 133	0 204 123 639	5679312	0 986 486 095	90095420	1 987 477 031	90271546	0 265 100 033
5 58 137	0 204 123 640	5 78 268	1 987 477 031	90095703	F 026 002 123	90272640	0 986 485 100
5 58 137	0 986 480 495	6235620	0 265 005 270	90095703	0 204 116 123	90272646	0 986 480 756
5 58 140	0 986 480 095	6235722	0 265 005 656	90095704	0 986 475 453	90272647	0 986 480 750
5 58 141	0 986 480 117	6235723	0 265 005 657	90112981	1 987 477 049	90272648	0 986 480 751
558143	0 986 480 856	6238162	0 265 005 261	90121718	1 987 476 020	90272651	0 986 480 892
558144	0 986 480 880	6238162	0 265 005 262	90125512	1 987 477 132	90272679	0 265 103 016
5 58 146	0 986 480 494	6238163	0 265 005 433	90125513	1 987 477 131	90272779	0 986 480 063
5 58 147	0 986 480 063	6238255	0 265 005 449	90141916	0 204 123 637	90273620	0 265 201 048
5 58 155	0 986 480 133	6238355	0 986 594 026	90141916	0 986 480 064	90287309	0 265 001 206
5 58 160	0 986 480 134	6238404	0 986 594 026	90142096	0 986 475 588	90287310	0 265 001 208
5 58 167	0 986 480 942	6238429	0 986 594 028	90147349	1 987 476 408	90287311	0 265 001 207
5 58 175	0 986 480 846	6 79 323	0 986 486 030	90166223	0 986 471 889	90295000	0 986 471 957
5 58 179	0 986 480 063	77 01 044 603	F 026 002 533	90166224	0 986 471 890	90295001	0 986 471 958
5 58 182	0 204 123 637	8 47 014	1 987 477 241	90167262	0 986 471 461	90295002	0 986 471 945
5 58 182	0 986 480 064	88960665	F 00H W00 002	90167528	0 986 475 019	90295003	0 986 471 946
558183	0 204 123 663	88960666	F 00H W00 001	90167529	0 986 475 021	90295416	0 986 480 065

90296446	0 204 123 637	90445985	1 987 477 309	90541290	0 265 003 093	9120635	0 986 480 493
90296446	0 986 480 064	90445986	1 987 477 310	90541298	0 261 231 115	9120710	1 987 476 032
90297376	0 986 480 752	90447335	1 987 477 769	90541362	0 265 216 410	9120711	1 987 476 432
90297497	0 265 103 034	90459666	0 265 001 220	90541364	0 265 208 355	9120943	1 987 476 700
90297553	0 986 480 892	90468319	1 987 476 464	90541521	0 261 231 116	9121372	0 204 004 320
90297557	0 986 480 756	90468320	1 987 476 564	90576453	1 987 477 660	9121377	0 204 004 321
90298201	0 261 231 006	90468900	1 987 477 391	90576454	1 987 477 661	9127100	0 265 220 430
90307088	0 265 001 226	90473314	1 987 476 690	90576559	0 265 220 458	9127187	1 987 477 667
90324081	1 987 477 241	90473452	1 987 476 691	90578369	0 986 486 036	9127787	1 987 477 668
90334462	1 987 477 130	90483637	0 986 594 028	90578481	0 986 486 095	9127787	1 987 477 764
90341204	0 265 001 235	90487038	0 986 485 125	90581267	1 987 477 765	9127978	0 265 216 475
90341206	0 265 001 237	90487039	0 986 485 109	90581267	1 987 477 868	9160431	1 987 476 907
90344095	0 265 208 311	90487042	0 986 471 905	90581456	0 986 475 869	9160432	1 987 476 906
90345528	1 987 477 133	90487043	0 986 471 906	90581565	0 986 486 063	9160433	1 987 476 905
90346045	0 265 001 233	90487045	0 986 471 913	9108241	1 987 477 662	9160551	1 987 482 013
90346046	0 265 001 232	90487046	0 986 471 914	9108242	1 987 477 663	9161236	F 026 002 532
90348213	0 986 480 907	90490042	0 261 231 115	9108243	1 987 477 664	9161236	0 204 116 532
90348654	0 265 100 039	90490435	0 265 216 496	9108245	1 987 477 665	9161237	F 026 002 533
90349004	0 265 200 041	90495223	1 987 477 141	9108247	1 987 477 666	9161237	0 204 116 533
90349598	0 265 103 038	90495224	1 987 477 143	9111219	0 204 102 052	9181239	0 265 005 261
90349857	0 986 471 949	90495787	1 987 476 644	9111220	0 204 102 054	9181239	0 265 005 262
90349858	0 986 471 950	90496480	0 265 220 450	9111459	0 204 004 320	9181240	0 265 005 433
90350609	0 265 206 003	90496480	0 265 220 532	9111463	0 204 004 321	9191143	1 987 477 767
90357231	0 265 003 094	90498066	0 265 216 474	9111487	1 987 482 012	9191216	1 987 477 763
90357232	0 265 003 093	90498300	0 986 475 143	9111490	1 987 477 261	9191225	1 987 477 769
90357232	0 265 003 094	90498319	1 987 476 805	9111643	1 987 481 151	9191262	1 987 476 202
90357233	0 265 006 487	90498330	1 987 476 904	9111645	1 987 481 150	9191263	1 987 476 203
90369384	0 986 471 820	90498331	1 987 476 201	9111662	1 987 481 152	9191264	1 987 476 425
90369385	0 986 471 821	90509675	0 986 485 133	91116673	1 987 477 116	9191574	1 987 477 669
90373855	1 987 477 766	90509676	0 986 480 133	91142432	1 987 476 911	9191578	1 987 477 670
90373923	1 987 477 129	90509678	0 986 480 134	91142436	1 987 476 910	9192236	0 265 216 475
90373926	1 987 477 308	90510188	0 265 003 094	91149880	1 987 481 147	9192240	0 265 202 458
90373927	1 987 477 307	90510189	0 265 006 487	9115064	0 986 594 027	9193119	0 265 005 433
90374075	0 986 475 032	90510190	0 265 001 134	91152686	1 987 482 170	9193213	0 986 480 134
90374076	0 986 475 143	90510208	0 265 001 220	91152687	1 987 482 171	9193214	0 986 480 133
90374106	1 987 476 464	90510275	0 265 006 486	91152688	1 987 482 110	9193220	0 986 480 846
90374841	1 987 477 250	90510281	0 261 231 006	91152689	1 987 482 111	9193228	0 986 480 493
90374902	1 987 477 130	90511177	0 261 231 079	91165521	1 987 482 043	9193479	0 265 220 456
90375403	1 987 477 142	90511653	2 267 000 724	91165522	1 987 482 145	9193479	0 265 220 645
90386504	0 986 594 028	90511653	2 267 000 735	91165523	1 987 477 137	9193481	0 265 220 583
90386505	0 986 594 025	90512265	0 265 220 025	91165524	1 987 477 116	9193483	0 265 220 585
90421703	1 987 477 140	90512840	0 986 480 920	91166506	1 987 476 700	9193483	0 265 220 637
90442034	0 265 208 311	90512841	0 986 480 929	91166507	1 987 476 914	9193485	0 265 220 659
90442135	0 265 208 311	90522656	0 986 486 030	91166639	1 987 482 042	9193487	0 265 216 479
90443259	0 986 475 032	90530434	0 261 231 116	91166640	1 987 482 146	9193976	0 204 102 955
90443261	0 986 475 143	90538629	1 987 477 258	9117170	0 265 220 449	9193977	0 204 102 956
90443390	0 265 001 236	90538656	0 265 220 449	9117172	0 265 216 473	9193978	0 204 102 957
90443391	0 265 003 050	90538698	1 987 477 129	9117652	0 265 216 474	9193979	0 204 102 958
90443391	0 265 006 488	90538699	1 987 477 310	9117654	0 265 220 450	9193980	0 204 102 959
90443861	0 986 480 758	90538700	1 987 477 309	9117654	0 265 220 532	9193981	0 204 102 960
90444700	0 986 471 820	90539000	0 265 208 355	9118549	0 265 006 488	9194884	0 265 202 480
90444701	0 986 471 821	90539252	1 987 476 644	9120525	0 265 216 652	9194884	0 265 202 492
90445758	1 987 476 030	90540170	0 986 471 018	9120532	0 265 220 532	9195321	0 204 102 950
90445761	1 987 476 144	90540171	0 986 471 017	9120534	0 265 220 458	9195322	0 204 102 951
90445764	1 987 476 694	90541132	0 986 594 026	9120538	0 265 220 430	9195528	0 204 125 742

◀ OPEL

9195530	0 204 123 540
9195531	0 204 123 542
9195630	0 265 005 261
9195630	0 265 005 262
9195631	0 265 005 433

9196400	0 265 005 303
9196452	0 204 102 955
9196454	0 204 102 957
9196455	0 204 102 958
9196456	0 204 102 959

9196457	0 204 102 960
9198883	0 265 220 645
9199230	0 986 480 887
9199236	0 986 480 831
9199239	0 204 031 108

9199636	0 265 005 435
9200584	0 265 005 434
9201353	0 986 471 017
9201627	0 265 202 492
9201631	0 265 220 637

9203995	1 987 477 995
9203996	1 987 477 771
9203999	0 204 031 174
9204000	1 987 476 909
92050124	0 265 213 013

92057843	0 265 219 459
92058944	0 265 219 459
92061913	0 261 231 007
9206661	1 987 476 908
92083318	0 265 219 459

9209092	0 986 475 886
9209928	1 987 477 771
9210280	0 204 031 174
9210312	1 987 477 772
9210314	1 987 477 771

92104014	0 265 231 036
92104017	0 265 233 009
9211155	1 987 482 136
9211156	1 987 482 137
9214007	0 204 204 712

9214008	0 204 204 711
9214419	0 204 104 298
9214420	0 204 104 299
92174558	0 265 233 009
92174559	0 265 233 009

92177581	0 265 231 036
9223129	1 987 477 527
9223133	1 987 477 528
9225541	1 987 477 869
93161164	0 986 480 827

93167537	0 204 125 870
93170200	0 265 216 479
93170362	0 265 005 262
93171071	0 204 102 959
93171072	0 204 102 960

93172000	0 265 216 479
93172088	0 986 480 858
93172089	0 986 480 993
93172437	0 265 202 503
93172439	0 265 231 307

93172441	0 265 234 051
93172445	0 265 202 509
93172447	0 265 202 513
93172949	0 265 005 449
93173458	0 265 220 659

93175087	0 986 480 884
93175322	0 986 480 885
93177171	0 261 231 173
93177196	0 265 005 270
93177396	0 265 231 444

93177765	0 204 125 812
93177766	0 204 125 813
93177767	0 204 123 637
93177768	0 204 123 638
93177769	0 204 123 639

93177770	0 204 123 640
93179177	0 986 480 856
93179178	0 986 480 880
93180105	0 261 231 181
93180405	0 261 231 181

93181109	1 987 477 907
93181110	1 987 477 907
93181375	0 986 480 828
93181438	0 204 123 659
93182130	0 265 231 584

93182132	0 265 231 586
93182547	0 265 234 094
93182612	0 204 123 662
93182621	1 987 481 186
93182623	1 987 481 057

93182830	0 265 231 584
93183405	0 204 125 827
93183406	0 204 123 664
93183407	0 204 123 663
93183554	1 987 481 074

93184900	0 265 234 340
93184902	0 265 234 324
93187126	0 265 005 656
93188091	0 265 231 538
93188093	0 265 231 844

93188095	0 265 230 286
93188095	0 265 235 164
93188097	0 265 230 288
93188097	0 265 235 060
93188239	0 265 005 656

93188239	0 265 005 657
93189202	0 261 231 174
93189275	0 265 007 671
93189276	0 265 007 768
93189276	0 265 007 896

93189277	0 265 007 769
93189739	0 204 125 869
93189743	0 204 123 738
93189744	0 204 123 739
93189747	0 204 123 742

93189748	0 204 123 743
93189750	0 204 123 745
93189793	0 204 004 562
93189794	0 204 004 563
93189797	0 204 004 564

93189797	0 204 902 119
93189798	0 204 004 565
93189798	0 204 902 120
93189801	0 204 004 566
93189802	0 204 004 567

93189817	0 204 902 004
93189818	0 204 902 005
93189986	0 986 475 949
93190824	0 265 234 624
93190824	0 265 234 683

93191690	0 204 902 030
93191691	0 204 902 031
93191695	0 204 902 032
93191695	0 204 902 119
93191696	0 204 902 033

93191696	0 204 902 120
93191704	1 987 481 186
93192439	0 265 008 077
93192617	0 265 234 683
93192751	0 265 230 288

93192753	0 265 232 239
93192755	0 265 230 286
93192757	0 265 234 697
93192759	0 265 234 695
93193435	0 204 011 407

93194900	0 265 008 078
93195180	0 204 054 366
93195181	0 204 054 376
93195184	0 204 051 327
93195185	0 204 054 382

93294467	0 265 006 488
93294647	0 265 006 488
93318894	1 987 477 936
93399899	0 261 231 176
93730859	0 265 220 711

93852188	1 987 477 137
93852189	1 987 477 116
93858411	0 265 008 077
93859336	0 265 008 041
93859337	0 265 008 042

93860619	0 265 008 078
97124878	1 987 476 338
97124879	1 987 476 342
97127616	0 986 475 807
97134829	1 987 476 147

97134830	1 987 476 911
97134831	1 987 476 549
97178011	0 204 123 508

PEUGEOT

AMN 453 032	0 204 116 301
AMN 453 05	0 986 475 590
AM 453 010 A	0 204 116 035

AM 453 03 A	0 204 122 007
AM 453 03 G	0 204 122 023
AM 453 04 B	0 204 116 031
AM 453 05 A	0 204 116 085
AZ 453 05	0 204 116 011

AZ 4530 5C	0 204 116 466
DXN 453 05	0 204 116 468
HY 456 37	0 204 131 007
V7 552 114	0 261 231 197
ZF 04 450 938	1 987 477 515

ZF 05 952 297	1 987 476 548
ZF 07 567 861	1 987 476 462
ZF 07 567 862	1 987 476 463
ZF 09 937 665	F 026 003 150
ZF 09 937 665	0 204 122 150

ZF 09 938 829	F 026 003 150
ZF 09 938 829	0 204 122 150
ZF 09 938 868	0 986 475 420
ZF 09 942 427	0 986 475 056
0265 216 303	1 267 000 820

0273 004 088	2 267 000 732
12 959 200	0 204 163 006
13 228 200	0 204 162 013
1348 980 080	1 987 482 214
13 533 600	0 204 162 018

1354 55	F 026 002 506
1354 55	0 204 116 506
1354 57	0 986 475 230
13 896 800	0 204 131 103
14 769 310	0 204 131 085

14 888 410	0 265 007 083
14 916 620	0 265 006 731
16 463 700	0 204 162 020
16 939 800	0 204 162 022
17 473 700	0 204 123 022

1747 42	F 026 002 087
1747 42	0 204 116 087
17 511 000	0 204 116 090
17 671 900	0 204 123 469
1768 00	0 986 475 230

1920 FR	0 261 231 168
1920 LT	0 261 231 197
2086 01	0 204 163 015
2086 02	0 204 163 016
2086 04	F 026 005 517

2086 06	0 204 163 019
2086 07	0 204 163 019
2086 08	F 026 005 517
2086 10	0 204 163 020
2086 12	0 204 163 007
2086 16	0 204 163 014
2095 11	0 204 162 006
2095 12	0 204 162 004
2095 13	0 204 162 008
2095 14	0 204 162 015
2095 16	0 204 162 026
2095 18	0 204 162 029
25 568 000	0 204 131 032
4033 119 720	0 204 123 227
42 254 02A	1 987 477 075
43 216 000	0 204 162 031
43 248 600	0 204 104 034
43 255 500	0 204 104 035
4400 A3	0 986 471 869
4400 A4	0 986 471 870
4400 C2	0 204 102 267
4400 C3	0 204 102 268
4400 C4	0 986 471 885
4400 C5	0 986 471 886
4400 C8	0 204 102 281
4400 C9	0 204 102 282
4400 E4	0 986 471 887
4400 E5	0 986 471 888
4400 E6	0 204 102 267
4400 E7	0 204 102 268
4400 F2	0 204 102 287
4400 F3	0 204 102 288
4400 F4	0 204 102 289
4400 F5	0 204 102 290
4400 F7	0 204 102 521
4400 F7	0 204 205 235
4400 F8	0 204 102 523
4400 F8	0 204 205 236
4400 F9	0 986 471 885
4400 G0	0 986 471 886
4400 G1	0 204 102 228
4400 G2	0 204 102 229
4400 G5	0 986 471 024
4400 G5	0 986 471 869
4400 G6	0 986 471 023
4400 G6	0 986 471 870
4400 G7	0 986 471 887
4400 G8	0 986 471 888
4400 H1	0 204 102 186
4400 H2	0 204 102 188
4400 H3	0 204 102 190
4400 H4	0 204 102 192
4400 H5	0 204 102 194
4400 H6	0 204 102 196
4400 J0	0 204 102 594

4400 J1	0 204 102 595
4400 J2	0 204 102 609
4400 J3	0 204 102 610
4400 J4	0 986 471 887
4400 J5	0 986 471 888
4400 J6	0 204 102 647
4400 J7	0 204 102 648
4400 K1	0 204 102 289
4400 K2	0 204 102 290
4400 K3	0 204 102 751
4400 K4	0 204 102 752
4400 K5	0 204 102 759
4400 K6	0 204 102 760
4400 K7	0 204 102 763
4400 K8	0 204 102 764
4400 K9	0 986 471 885
4400 L0	0 986 471 886
4400 L4	0 204 102 961
4400 L5	0 204 102 962
4400 L6	0 204 102 963
4400 L7	0 204 102 964
4400 L8	0 204 102 965
4400 L9	0 204 102 966
4400 N0	0 204 102 971
4400 N1	0 204 102 972
4400 N8	0 204 102 989
4400 N9	0 204 102 990
4400 P0	0 204 102 991
4400 P1	0 204 102 992
4400 P2	0 204 102 993
4400 P3	0 204 102 994
4400 R4	0 204 205 113
4400 R5	0 204 205 114
4400 R6	0 204 004 451
4400 R7	0 204 004 452
4400 R8	0 204 004 449
4400 R9	0 204 004 450
4400 T0	0 204 205 740
4400 T1	0 204 205 741
4400 T7	0 204 207 082
4400 T8	0 204 207 083
4400 68	0 204 102 226
4400 69	0 204 102 227
4400 75	0 204 102 224
4400 76	0 204 102 225
4400 83	0 986 471 672
4400 84	0 986 472 672
4400 85	0 986 471 776
4400 86	0 986 471 777
4400 89	0 204 102 228
4400 90	0 204 102 229
4400 91	0 986 471 778
4400 92	0 986 471 779
4400 93	0 204 102 241
4400 93	0 204 102 289

4400 94	0 204 102 242
4400 94	0 204 102 290
4401 A2	0 204 102 277
4401 A3	0 204 102 278
4401 G8	0 204 004 330
4401 G9	0 204 004 331
4401 N8	0 204 902 044
4401 N9	0 204 902 045
4401 49	0 204 102 017
4401 50	0 204 102 019
4401 50	0 204 102 654
4401 57	0 204 102 231
4401 58	0 204 102 232
4401 59	0 204 102 233
4401 60	0 204 102 234
4401 61	0 204 102 075
4401 62	0 204 102 077
4401 63	0 986 471 659
4401 64	0 986 472 659
4401 64	0 986 472 677
4401 67	0 986 471 691
4401 68	0 986 472 691
4401 70	0 986 471 666
4401 71	0 986 472 666
4401 72	0 986 471 683
4401 73	0 986 472 683
4402 A0	0 986 475 636
4402 A1	0 986 475 635
4402 A2	0 204 116 179
4402 A3	0 986 475 802
4402 A4	0 986 475 801
4402 A5	0 986 475 803
4402 A6	0 986 475 796
4402 A7	F 026 002 181
4402 A7	0 204 116 181
4402 A8	0 986 475 797
4402 C1	F 026 002 183
4402 C1	0 204 116 183
4402 C2	F 026 002 184
4402 C2	0 204 116 184
4402 C3	0 986 475 797
4402 C4	F 026 002 244
4402 C4	0 204 116 244
4402 C5	F 026 002 245
4402 C5	0 204 116 245
4402 C6	0 986 475 836
4402 C7	F 026 002 471
4402 C7	0 204 116 471
4402 C8	0 986 475 833
4402 C9	F 026 002 535
4402 C9	0 204 116 535
4402 E0	F 026 002 536
4402 E0	0 204 116 536
4402 E1	0 986 475 907
4402 E3	0 986 475 909

4402 E4	0 986 475 906
4402 E6	0 204 011 463
4402 F0	0 204 116 607
4402 F1	0 204 214 282
4402 F9	0 204 011 407
4402 09	F 026 002 006
4402 14	0 204 116 014
4402 28	F 026 002 037
4402 29	0 204 116 038
4402 32	0 204 116 047
4402 34	0 204 116 039
4402 37	0 204 116 078
4402 38	F 026 002 053
4402 39	0 204 116 097
4402 40	0 204 116 096
4402 41	F 026 002 091
4402 41	0 204 116 091
4402 42	F 026 002 092
4402 42	0 204 116 092
4402 43	0 204 116 095
4402 44	F 026 002 507
4402 44	0 204 116 507
4402 47	0 986 475 233
4402 48	0 986 475 234
4402 49	0 986 475 231
4402 50	F 026 002 093
4402 50	0 204 116 093
4402 52	0 986 475 781
4402 54	0 204 116 514
4402 55	F 026 002 088
4402 55	0 204 116 088
4402 56	F 026 002 110
4402 56	0 204 116 110
4402 57	0 986 475 428
4402 59	0 986 475 512
4402 62	F 026 002 506
4402 62	0 204 116 506
4402 63	F 026 002 087
4402 63	0 204 116 087
4402 63	0 986 475 209
4402 65	F 026 002 204
4402 65	0 204 116 204
4402 65	0 986 475 141
4402 66	F 026 002 205
4402 66	0 204 116 205
4402 67	F 026 002 216
4402 67	0 204 116 202
4402 68	F 026 002 217
4402 68	0 204 116 203
4402 70	0 986 475 420
4402 73	F 026 002 520
4402 73	0 204 116 520
4402 74	F 026 002 521
4402 74	0 204 116 521
4402 75	0 986 475 513



◀ PEUGEOT

4402 76	0 986 475 842	4535 CJ	0 204 125 942	4535 53	0 204 125 015	4541 K7	0 265 234 053
4402 77	F 026 002 135	4535 CK	0 204 125 944	4535 61	0 204 125 016	4541 K8	0 265 234 459
4402 77	0 204 116 135	4535 CL	0 204 125 943	4535 64	0 204 125 508	4541 L7	0 265 234 061
4402 78	F 026 002 136	4535 CN	0 204 125 945	4535 66	0 204 125 020	4541 L8	0 265 235 011
4402 78	0 204 116 136	4535 C8	0 204 125 445	4535 67	0 204 125 298	4541 08	0 265 208 305
4402 79	F 026 002 176	4535 C9	0 204 125 746	4535 68	0 204 125 042	4541 11	0 265 201 058
4402 79	0 204 116 127	4535 E1	0 204 125 134	4535 70	0 204 125 042	4541 12	0 265 201 056
4402 79	0 204 116 176	4535 E2	0 204 125 714	4535 71	0 204 125 019	4541 13	0 204 153 012
4402 79	0 204 116 390	4535 E3	0 204 125 715	4535 75	0 204 125 328	4541 17	0 265 208 321
4402 80	F 026 002 177	4535 E4	0 204 125 109	4535 81	0 204 125 058	4541 18	0 265 211 008
4402 80	0 204 116 126	4535 E5	0 204 125 716	4535 82	0 204 125 059	4541 23	0 265 216 303
4402 80	0 204 116 177	4535 E6	0 986 485 104	4535 83	0 204 125 345	4541 25	0 265 216 340
4402 81	0 986 475 612	4535 E7	0 986 485 105	4535 84	0 986 485 097	4541 31	0 265 216 342
4402 82	F 026 002 208	4535 F0	0 204 125 079	4535 86	0 204 125 084	4541 33	0 265 216 341
4402 82	0 204 116 208	4535 F3	0 204 125 139	4535 88	0 204 125 082	4541 34	0 265 216 483
4402 83	F 026 002 209	4535 F4	0 204 125 145	4535 9A	0 204 125 094	4541 35	0 265 216 484
4402 83	0 204 116 209	4535 F5	0 204 125 141	4535 94	0 204 125 094	4541 36	0 265 216 496
4402 84	0 204 116 023	4535 F6	0 204 125 143	4535 96	0 204 125 421	4541 38	0 265 216 554
4402 85	0 986 475 056	4535 F7	0 204 125 485	4535 97	0 204 125 418	4541 39	0 265 216 482
4402 86	0 986 475 619	4535 F8	0 204 125 484	4535 97	0 204 125 550	4541 40	0 265 216 436
4402 87	0 986 475 620	4535 G0	0 204 125 094	4541 A2	0 265 234 141	4541 41	0 265 216 530
4402 88	F 026 002 216	4535 H0	0 204 125 514	4541 A3	0 265 231 303	4541 44	0 265 216 641
4402 88	0 204 116 216	4535 H4	0 204 125 216	4541 A3	0 265 231 477	4541 45	0 265 216 544
4402 89	F 026 002 217	4535 H5	0 204 125 514	4541 A9	0 265 225 189	4541 46	0 265 216 699
4402 89	0 204 116 217	4535 J1	0 204 125 604	4541 C4	0 265 231 477	4541 48	0 265 216 605
4402 90	F 026 002 228	4535 J2	0 204 125 605	4541 C5	0 265 225 166	4541 49	0 265 202 419
4402 90	0 204 116 228	4535 J5	0 204 125 139	4541 C7	0 265 225 128	4541 50	0 265 216 643
4402 91	F 026 002 229	4535 J6	0 204 125 141	4541 C8	0 265 225 159	4541 51	0 265 216 721
4402 91	0 204 116 229	4535 K0	0 204 125 743	4541 EH	0 265 234 213	4541 52	0 265 216 725
4402 92	F 026 002 175	4535 K2	0 204 125 744	4541 EQ	0 265 230 078	4541 53	0 265 216 723
4402 92	0 204 116 175	4535 K3	0 204 125 734	4541 ET	0 265 231 975	4541 56	0 265 216 758
4402 93	F 026 002 222	4535 K4	0 204 125 748	4541 EW	0 265 235 362	4541 57	0 265 225 038
4402 93	0 204 116 222	4535 K5	0 204 125 749	4541 E2	0 265 234 053	4541 57	0 265 225 164
4402 94	F 026 002 223	4535 K6	0 204 125 751	4541 E3	0 265 231 487	4541 58	0 265 222 010
4402 94	0 204 116 223	4535 K7	0 204 125 750	4541 E4	0 265 234 145	4541 59	0 265 225 104
4402 95	F 026 002 128	4535 L4	0 204 125 772	4541 E8	0 265 231 523	4541 59	0 265 225 166
4402 95	0 204 116 128	4535 L6	0 204 125 773	4541 E9	0 265 234 061	4541 60	0 265 225 128
4402 97	F 026 002 234	4535 L7	0 204 125 776	4541 FQ	0 265 231 797	4541 61	0 265 231 303
4402 97	0 204 116 226	4535 L8	0 204 125 777	4541 F0	0 265 231 565	4541 61	0 265 231 477
4402 97	0 204 116 234	4535 L9	0 204 125 779	4541 F5	0 265 231 580	4541 62	0 265 216 863
4402 98	F 026 002 235	4535 N0	0 204 125 780	4541 F7	0 265 234 153	4541 66	0 265 216 544
4404 06	0 204 102 091	4535 N5	0 204 125 792	4541 GQ	0 265 231 975	4541 70	0 265 225 164
4439 22	0 204 100 377	4535 N6	0 204 125 791	4541 GT	0 265 235 362	4541 72	0 265 225 164
4448 22	0 204 104 025	4535 R0	0 204 125 801	4541 GW	0 265 232 349	4541 76	0 265 225 159
4448 31	0 204 104 027	4535 R4	0 204 125 804	4541 G9	0 265 234 141	4541 77	0 265 225 189
4448 37	0 204 104 063	4535 R5	0 204 125 805	4541 HX	0 265 230 492	4541 94	0 265 231 303
4448 60	0 204 104 070	4535 R7	0 204 125 035	4541 H8	0 265 234 038	4541 94	0 265 231 477
4448 61	0 204 104 049	4535 T7	0 204 125 822	4541 H9	0 265 234 153	4541 96	0 265 225 216
4448 63	0 204 104 068	4535 T8	0 204 125 821	4541 JP	0 265 232 393	4541 97	0 265 225 130
4535 AA	0 204 125 901	4535 T9	0 204 125 820	4541 J1	0 265 231 487	4541 99	0 265 225 189
4535 AC	0 204 125 902	4535 V0	0 204 125 823	4541 J2	0 265 234 053	4542 A4	0 265 109 089
4535 A4	0 204 125 420	4535 V5	0 204 125 831	4541 J3	0 265 234 153	4542 10	0 265 100 066
4535 A5	0 204 125 102	4535 V6	0 204 125 830	4541 J4	0 265 234 396	4542 11	0 265 100 073
4535 A6	0 204 125 104	4535 Y7	0 204 125 837	4541 J5	0 265 231 523	4542 18	0 265 100 073
4535 A9	0 204 125 079	4535 49	0 204 125 009	4541 K5	0 265 234 461	4542 22	2 267 000 724

4542 22	2 267 000 735
4542 27	2 267 000 735
4542 34	2 267 000 740
4542 36	1 267 000 821
4542 43	1 267 000 828
4542 50	2 267 000 740
4542 54	2 267 000 735
4542 57	1 267 000 821
4542 61	0 265 109 415
4542 66	0 265 109 432
4542 67	0 265 109 089
4542 67	0 265 109 414
4542 69	0 265 109 089
4542 69	0 265 109 414
4542 70	0 265 109 089
4542 89	0 265 109 089
4545 A4	0 265 006 732
4545 A8	0 265 006 793
4545 C2	0 265 007 664
4545 C3	0 265 007 780
4545 C4	0 265 007 779
4545 C7	0 265 007 665
4545 C8	0 265 007 666
4545 C9	0 265 007 668
4545 E0	0 265 007 667
4545 E1	0 265 007 687
4545 E2	0 265 007 688
4545 E3	0 265 005 486
4545 E5	0 265 007 707
4545 E6	0 265 007 883
4545 E7	0 265 007 788
4545 E8	0 265 007 789
4545 E9	0 265 007 790
4545 F0	0 265 007 791
4545 F6	0 265 008 017
4545 F7	0 265 008 018
4545 F8	0 265 008 018
4545 F9	0 265 005 486
4545 H7	0 265 008 018
4545 H8	0 265 005 517
4545 J8	0 265 008 485
4545 11	0 265 003 064
4545 12	0 265 003 065
4545 21	0 265 003 072
4545 21	0 265 003 126
4545 21	0 265 006 207
4545 22	0 265 003 073
4545 22	0 265 003 127
4545 22	0 265 006 208
4545 23	0 265 003 080
4545 23	0 265 003 123
4545 23	0 265 006 314
4545 25	0 265 005 111
4545 27	0 204 150 083
4545 28	0 265 003 100

4545 28	0 265 003 124
4545 28	0 265 006 315
4545 31	0 265 003 099
4545 31	0 265 006 201
4545 32	0 265 006 200
4545 33	0 265 003 079
4545 33	0 265 003 129
4545 33	0 265 006 202
4545 34	0 265 006 204
4545 35	0 265 003 128
4545 35	0 265 006 199
4545 36	0 265 003 129
4545 36	0 265 006 202
4545 37	0 265 003 123
4545 37	0 265 006 314
4545 44	0 265 006 201
4545 45	0 265 006 200
4545 46	0 265 006 202
4545 47	0 265 006 199
4545 48	0 265 006 205
4545 49	0 265 006 206
4545 50	0 265 006 203
4545 51	0 265 006 204
4545 54	0 986 594 021
4545 55	0 265 006 207
4545 56	0 265 006 202
4545 56	0 265 006 208
4545 57	0 986 594 020
4545 60	0 265 006 314
4545 61	0 265 006 315
4545 62	0 265 006 209
4545 66	0 265 006 389
4545 67	0 265 006 388
4545 68	0 265 006 426
4545 69	0 265 006 441
4545 70	0 265 006 427
4545 71	0 265 006 405
4545 72	0 265 006 406
4545 74	0 986 594 019
4545 75	0 265 006 504
4545 76	0 986 594 022
4545 78	0 265 006 389
4545 82	0 265 006 544
4545 83	0 265 006 545
4545 84	0 265 005 404
4545 85	0 265 006 659
4545 88	0 265 007 423
4545 89	0 265 007 424
4545 92	0 265 006 730
4545 93	0 265 006 731
4545 94	0 265 007 083
4545 95	0 265 007 084
4549 05	0 265 005 211
4549 05	0 265 005 290
4549 07	0 265 005 290

4549 16	0 265 005 290
4549 17	0 265 005 606
4549 21	0 265 005 715
4549 26	0 265 005 714
4549 27	0 265 005 292
4549 27	0 265 005 715
4549 28	0 265 005 629
4549 28	0 265 005 724
4549 33	0 265 005 629
4549 33	0 265 005 724
4549 39	0 265 005 714
4549 43	0 265 005 724
4599 15	0 204 120 018
4599 21	0 204 120 023
4601 A1	F 026 003 518
4601 A2	F 026 003 103
4601 A3	F 026 003 243
4601 A3	0 204 122 243
4601 A4	0 986 480 912
4601 A6	0 204 123 160
4601 A7	F 026 003 168
4601 A7	0 204 123 168
4601 A8	F 026 003 170
4601 A8	0 204 123 170
4601 A9	0 204 123 172
4601 C0	F 026 003 174
4601 C0	0 204 123 174
4601 C1	F 026 003 168
4601 C1	0 204 123 168
4601 C2	F 026 003 170
4601 C2	0 204 123 170
4601 C4	0 204 123 162
4601 C8	F 026 003 318
4601 C8	0 204 123 318
4601 C9	0 204 123 319
4601 D0	0 204 123 320
4601 D1	F 026 003 313
4601 D1	0 204 123 313
4601 D2	0 204 123 314
4601 D3	F 026 003 315
4601 D3	0 204 123 315
4601 E0	0 204 123 186
4601 E1	F 026 003 166
4601 E1	0 204 123 166
4601 E2	0 204 123 182
4601 E3	F 026 003 188
4601 E3	0 204 123 188
4601 E4	F 026 003 518
4601 E6	F 026 003 315
4601 E6	0 204 123 315
4601 E7	0 204 123 325
4601 E8	F 026 003 190
4601 E8	0 204 123 190
4601 E9	F 026 003 192
4601 E9	0 204 123 192

4601 F0	F 026 003 207
4601 F0	0 204 123 207
4601 F1	F 026 003 342
4601 F1	0 204 123 342
4601 F2	F 026 003 208
4601 F2	0 204 123 208
4601 F4	F 026 003 342
4601 F4	0 204 123 342
4601 F5	F 026 003 349
4601 F5	0 204 123 349
4601 F6	0 204 123 350
4601 F8	0 986 480 939
4601 F9	F 026 003 502
4601 F9	0 204 123 502
4601 G0	F 026 003 342
4601 G0	0 204 123 342
4601 G0	0 986 480 663
4601 G1	F 026 003 190
4601 G1	0 204 123 190
4601 G3	0 204 123 344
4601 G4	0 204 123 341
4601 H0	0 986 480 835
4601 H4	F 026 003 180
4601 H4	0 204 123 180
4601 H5	0 986 480 854
4601 H8	F 026 003 180
4601 H8	0 204 123 180
4601 H9	0 204 123 373
4601 J2	F 026 003 419
4601 J2	0 204 123 419
4601 J3	F 026 003 502
4601 J3	0 204 123 502
4601 J4	F 026 003 501
4601 J4	0 204 123 501
4601 J7	F 026 003 512
4601 J7	0 204 123 512
4601 J8	0 204 123 511
4601 J9	F 026 003 188
4601 J9	0 204 123 519
4601 K0	F 026 003 518
4601 K0	0 204 123 518
4601 K1	F 026 003 517
4601 K1	0 204 123 517
4601 K2	F 026 003 516
4601 K2	0 204 123 516
4601 K3	0 204 123 545
4601 K4	0 204 123 544
4601 K5	0 204 123 536
4601 L0	0 204 123 597
4601 L1	0 204 123 598
4601 L2	0 204 123 596
4601 L3	0 204 123 595
4601 L5	0 986 480 876
4601 L6	0 204 123 592
4601 L9	0 986 480 879



◀ PEUGEOT

4601 N5	0 204 123 616	4601 87	0 204 123 075	4745 J6	1 987 477 578	4745 Y2	1 987 477 951
4601 N6	0 204 123 615	4601 88	F 026 003 150	4745 J7	1 987 477 579	4745 Y3	1 987 477 952
4601 N9	0 204 123 546	4601 88	0 204 122 150	4745 J8	1 987 477 580	4745 Y6	1 987 477 953
4601 P0	0 204 123 584	4601 90	0 204 123 160	4745 J9	1 987 477 581	4745 Y7	1 987 477 953
4601 P5	F 026 003 633	4601 93	0 204 123 094	4745 K4	1 987 477 443	4745 Y8	1 987 477 954
4601 P5	0 204 123 633	4601 94	F 026 003 096	4745 K5	1 987 482 103	4745 Y9	1 987 477 993
4601 P8	0 204 123 644	4601 94	F 026 003 180	4745 K6	1 987 482 113	4745 Z0	1 987 477 823
4601 P9	0 204 123 645	4601 95	0 986 480 906	4745 K7	1 987 482 114	4745 Z3	1 987 477 235
4601 R0	0 204 123 653	4601 97	F 026 003 103	4745 K8	1 987 477 445	4745 Z4	1 987 477 237
4601 R3	0 204 123 667	4601 98	F 026 003 142	4745 K9	1 987 477 446	4745 Z7	1 987 482 000
4601 R4	0 204 123 666	4601 98	0 204 123 142	4745 L3	1 987 477 575	4745 Z8	1 987 482 001
4601 T2	0 204 123 746	4604 G2	0 204 123 343	4745 L4	1 987 477 575	4745 39	1 987 477 479
4601 T5	0 204 123 747	4633 A3	0 204 124 142	4745 L5	1 987 477 571	4745 40	1 987 477 416
4601 V0	0 204 123 737	4633 A4	0 204 124 144	4745 L6	1 987 477 573	4745 41	1 987 477 479
4601 V1	0 204 123 736	4633 31	0 204 124 006	4745 N3	1 987 482 115	4745 51	1 987 477 479
4601 W6	0 204 123 787	4649 28	0 265 005 629	4745 N4	1 987 477 586	4745 52	1 987 477 417
4601 W7	0 204 123 786	4649 28	0 265 005 724	4745 N5	1 987 477 587	4745 54	1 987 477 419
4601 W8	0 204 123 809	4745 A0	1 987 477 432	4745 N8	1 987 477 434	4745 57	1 987 477 420
4601 W9	0 204 123 813	4745 A1	1 987 477 431	4745 N9	1 987 477 435	4745 58	1 987 477 421
4601 X0	0 204 123 811	4745 A2	1 987 477 432	4745 P0	1 987 477 774	4745 63	1 987 477 144
4601 X1	0 204 123 815	4745 A4	1 987 477 434	4745 P1	1 987 477 870	4745 64	1 987 477 145
4601 12	0 204 122 008	4745 A5	1 987 477 435	4745 P2	1 987 477 870	4745 65	1 987 477 146
4601 18	0 204 122 028	4745 E8	1 987 477 436	4745 P5	1 987 477 590	4745 66	1 987 477 151
4601 20	0 204 122 011	4745 E9	1 987 477 565	4745 P6	1 987 477 591	4745 67	1 987 477 273
4601 23	0 204 122 029	4745 F0	1 987 477 566	4745 P7	1 987 477 592	4745 68	1 987 477 272
4601 26	0 204 123 001	4745 F1	1 987 477 567	4745 P8	1 987 477 593	4745 69	1 987 477 270
4601 27	0 204 122 021	4745 F2	1 987 477 568	4745 P9	1 987 477 594	4745 70	1 987 477 271
4601 40	0 204 122 035	4745 F3	1 987 477 569	4745 R0	1 987 477 595	4745 71	1 987 477 422
4601 45	0 204 122 029	4745 F4	1 987 477 525	4745 R3	1 987 477 596	4745 73	1 987 477 148
4601 48	F 026 003 025	4745 F5	1 987 477 524	4745 R4	1 987 477 597	4745 74	1 987 477 147
4601 48	0 204 123 025	4745 F7	1 987 477 437	4745 R5	1 987 477 712	4745 75	1 987 477 149
4601 50	0 204 123 056	4745 F8	1 987 477 079	4745 R7	1 987 477 871	4745 76	1 987 477 150
4601 51	0 204 123 037	4745 F9	1 987 477 078	4745 R8	1 987 477 871	4745 82	1 987 477 688
4601 52	0 204 123 055	4745 G0	1 987 477 438	4745 T3	1 987 477 598	4745 89	1 987 477 427
4601 53	0 204 122 045	4745 G1	1 987 477 323	4745 T4	1 987 477 442	4745 97	1 987 477 429
4601 57	0 204 123 051	4745 G2	1 987 477 114	4745 T5	1 987 477 565	4745 98	1 987 477 430
4601 60	0 204 122 047	4745 G3	1 987 477 113	4745 T6	1 987 477 713	4745 99	1 987 477 431
4601 65	F 026 003 057	4745 G4	1 987 482 046	4745 T8	1 987 477 714	4746 V6	1 987 482 002
4601 65	0 204 123 057	4745 G5	1 987 477 439	4745 T9	1 987 477 775	4746 10	1 987 482 118
4601 71	F 026 003 054	4745 G6	1 987 477 440	4745 V0	1 987 477 599	4746 11	1 987 482 007
4601 71	0 204 123 054	4745 G7	1 987 477 115	4745 V2	1 987 477 262	4746 12	1 987 482 008
4601 72	0 204 123 053	4745 G8	1 987 477 773	4745 V3	1 987 482 006	4746 13	1 987 477 993
4601 73	0 204 122 273	4745 G9	1 987 477 568	4745 V4	1 987 482 003	4746 14	1 987 482 112
4601 76	F 026 003 058	4745 H0	1 987 477 575	4745 V5	1 987 477 263	4746 15	1 987 477 238
4601 76	0 204 123 058	4745 H1	1 987 477 570	4745 V7	1 987 482 004	4746 16	1 987 477 239
4601 78	0 204 123 001	4745 H2	1 987 477 571	4745 W3	1 987 477 822	4746 17	1 987 482 213
4601 80	F 026 003 064	4745 H3	1 987 477 572	4745 W4	1 987 477 823	4746 18	1 987 482 214
4601 80	0 204 123 064	4745 H4	1 987 477 573	4745 X1	1 987 477 115	4746 19	1 987 477 954
4601 82	0 204 122 044	4745 H5	1 987 477 441	4745 X2	1 987 482 116	4746 20	1 987 477 598
4601 83	F 026 003 150	4745 H7	1 987 477 442	4745 X4	1 987 477 994	4746 30	1 987 477 775
4601 83	0 204 122 150	4745 H9	1 987 477 575	4745 X5	1 987 477 592	4746 31	1 987 482 190
4601 84	F 026 003 033	4745 J0	1 987 477 576	4745 X8	1 987 477 576	4746 34	1 987 482 000
4601 84	0 204 123 033	4745 J2	1 987 482 005	4745 X9	1 987 477 595	4746 35	1 987 482 001
4601 85	0 204 123 180	4745 J3	1 987 477 577	4745 Y0	1 987 482 116	4746 42	1 987 482 206
4601 87	F 026 003 075	4745 J5	1 987 477 440	4745 Y1	1 987 482 117	4746 43	1 987 482 205

4746 44	1 987 482 208	4806 66	1 987 476 951	4861 20	0 204 131 024	5 401 711	0 204 122 032
4746 45	1 987 482 207	4806 67	1 987 476 947	4861 21	0 204 131 019	5 411 942	0 204 116 035
4806 A0	1 987 476 912	4806 68	1 987 476 679	4861 26	0 204 131 024	5 411 942 G	0 204 116 035
4806 A1	1 987 476 913	4806 69	1 987 476 677	4861 27	0 204 131 035	5 418 738	0 204 123 005
4806 A6	1 987 476 072	4806 70	1 987 481 063	4861 32	0 204 131 226	5 418 738 B	0 204 123 005
4806 A8	1 987 476 785	4806 71	1 987 476 329	4861 33	0 204 131 037	5 436 616	0 204 131 012
4806 C0	1 987 476 867	4806 72	1 987 481 017	4861 38	0 204 131 226	5 479 183	0 204 122 025
4806 C1	1 987 476 078	4806 74	1 987 476 519	4861 42	0 204 131 045	5 479 184	F 026 003 039
4806 C3	1 987 481 004	4806 75	1 987 476 148	4861 43	0 204 131 044	5 479 184	0 204 122 039
4806 C4	1 987 476 629	4806 77	1 987 481 002	4861 44	0 986 482 009	5 488 527	F 026 002 083
4806 C7	1 987 481 002	4806 78	1 987 476 678	4861 45	0 204 131 049	5 488 527	0 204 116 083
4806 C8	1 987 481 018	4806 79	1 987 476 809	4861 46	0 986 482 005	5 488 527 C	F 026 002 083
4806 C9	1 987 481 019	4806 80	1 987 476 810	4861 47	0 986 482 005	5 488 527 C	0 204 116 083
4806 E0	1 987 476 785	4806 81	1 987 476 679	4861 49	0 204 131 048	5 488 528	0 204 116 084
4806 E1	1 987 476 780	4806 82	1 987 476 951	4861 50	0 204 131 046	5 490 764 T	0 204 123 049
4806 E2	1 987 476 355	4806 83	1 987 476 844	4861 52	0 204 131 053	5887 6A	F 026 002 087
4806 E3	1 987 476 178	4806 84	1 987 476 785	4861 53	0 204 131 052	5887 6A	0 204 116 087
4806 E7	1 987 476 372	4806 85	1 987 476 651	4861 54	0 204 131 064	5 925 334	1 987 477 419
4806 E8	1 987 476 374	4806 86	1 987 476 178	4861 55	0 204 131 065	5946 03	0 261 231 006
4806 E9	1 987 476 651	4806 91	1 987 476 785	4861 60	0 204 131 067	5946 05	0 261 231 007
4806 F3	1 987 481 004	4806 92	1 987 476 746	4861 61	0 204 131 069	5946 15	0 261 231 071
4806 F6	1 987 476 457	4806 93	1 987 476 915	4861 63	0 204 131 082	5946 17	0 261 231 071
4806 20	1 987 476 150	4806 94	1 987 476 914	4861 64	0 204 131 084	5946 18	0 261 231 070
4806 22	1 987 476 863	4806 95	1 987 476 979	4861 65	0 204 131 232	5946 21	0 261 231 045
4806 23	1 987 476 666	4806 96	1 987 476 329	4861 66	0 204 031 050	5946 22	0 261 231 109
4806 24	1 987 476 548	4806 97	1 987 476 870	4861 66	0 204 131 217	5946 23	0 261 231 188
4806 26	1 987 476 667	4806 98	1 987 476 869	4861 67	0 204 131 086	5946 25	0 261 231 125
4806 29	1 987 476 519	4816 14	1 987 476 680	4861 68	0 204 131 067	5946 28	0 261 231 128
4806 30	1 987 476 668	4816 16	1 987 476 681	4861 69	0 204 131 085	5946 30	0 261 231 130
4806 31	1 987 476 521	4816 21	1 987 476 682	4861 72	0 204 131 232	63 120 300	0 204 102 205
4806 32	1 987 476 522	4816 22	1 987 476 683	4861 73	0 204 131 092	63 227 500	0 204 123 022
4806 34	1 987 476 668	4816 23	1 987 476 684	4861 74	0 204 131 093	7401 367 643	0 261 231 007
4806 35	1 987 476 463	4816 24	1 987 476 954	4861 77	0 986 482 029	75 422 063	1 987 476 491
4806 36	1 987 476 462	4816 25	1 987 476 685	4861 78	0 204 131 082	75 491 955	0 204 116 467
4806 37	1 987 476 520	4816 26	1 987 476 686	4861 79	0 204 131 084	75 491 956	0 204 116 298
4806 39	1 987 476 531	4816 27	1 987 476 244	4861 80	0 204 131 256	75 492 063	1 987 476 491
4806 40	1 987 476 670	4816 29	1 987 476 523	4861 84	0 204 131 270	75 494 063	1 987 476 491
4806 41	1 987 476 532	4816 31	1 987 476 688	4861 85	0 204 131 271	75 510 162	1 987 477 075
4806 42	1 987 476 534	4816 35	1 987 476 688	4861 86	0 204 131 272	7700 772 310	0 265 001 068
4806 44	1 987 476 673	4816 36	1 987 476 689	4861 89	0 204 131 257	7901 440 247	0 986 475 233
4806 45	1 987 476 669	4834 71	1 987 477 449	4861 90	0 204 131 258	7901 440 248	0 986 475 234
4806 46	1 987 476 534	4834 72	1 987 477 450	4861 91	0 204 131 268	7901 440 249	0 986 475 231
4806 47	1 987 476 670	4834 75	1 987 477 451	4861 92	0 204 131 269	7901 444 837	0 204 104 063
4806 48	1 987 476 532	4834 80	1 987 477 452	4861 95	0 204 031 109	7910 017 919	0 204 123 056
4806 50	1 987 476 521	4834 81	1 987 477 453	4861 95	0 204 131 328	7910 018 046	0 204 123 055
4806 52	1 987 476 671	4834 85	1 987 477 455	4861 96	0 204 031 110	7910 018 158	1 987 476 684
4806 53	1 987 476 523	4861 A2	0 204 031 184	4861 96	0 204 131 329	7910 022 381	0 204 131 035
4806 54	1 987 476 520	4861 A4	0 204 031 202	4861 99	0 204 031 181	7910 027 051	0 204 123 051
4806 55	1 987 476 672	4861 A5	0 204 031 182	4883 72	F 026 002 506	7910 027 463	0 204 131 038
4806 56	1 987 476 558	4861 A6	0 204 031 183	4883 72	0 204 116 506	7910 030 170	F 026 002 094
4806 58	1 987 476 673	4861 A7	0 204 031 185	4915 0M	F 026 002 087	7910 030 170	0 204 116 094
4806 62	1 987 476 675	4861 C2	0 204 031 277	4915 0M	0 204 116 087	91 500 635	1 987 476 686
4806 63	1 987 476 559	4861 02	0 204 131 001	51 784 533	1 987 482 206	91 503 888	0 204 162 029
4806 64	1 987 476 676	4861 08	0 204 131 010	5 400 817	0 204 116 034	91 504 162	F 026 003 057
4806 65	1 987 476 560	4861 18	0 204 131 038	5 400 817 H	0 204 116 034	91 504 162	0 204 123 057

◀ PEUGEOT

91 507 930	0 204 125 020
91 510 533	F 026 003 243
91 510 533	0 204 122 243
91 510 872	F 026 003 064
91 510 872	0 204 123 064
9151 487 880	0 261 231 001
91 514 880	0 261 231 006
91 515 816	1 987 476 519
91 521 171	F 026 003 054
91 521 171	0 204 123 054
93 327 326	0 265 006 389
9404 402 708	0 986 475 420
9404 402 868	0 986 475 619
9404 402 878	0 986 475 620
9404 541 AF8	0 265 235 011
94 045 41A98	0 265 225 189
9404 541 C48	0 265 231 477
94 045 41EH8	0 265 234 213
94 045 41EQ8	0 265 230 078
94 045 41ET8	0 265 231 975
94 045 41EW8	0 265 235 362
94 045 41FK8	0 265 231 797
94 045 41FQ8	0 265 231 797
94 045 41GQ8	0 265 231 975
94 045 41GT8	0 265 235 362
94 045 41GW8	0 265 232 349
94 045 41GY8	0 265 230 492
9404 541 G98	0 265 234 141
94 045 41HX8	0 265 230 492
94 045 41JP8	0 265 232 393
9404 541 L98	0 265 234 053
94 045 41N88	0 265 234 213
9404 541 P78	0 265 234 038
9404 541 R28	0 265 234 396
94 045 41Y68	0 265 231 797
9404 541 568	0 265 216 758
9404 541 628	0 265 216 863
9404 541 968	0 265 225 216
9404 601 858	F 026 003 243
9404 601 858	0 204 122 243
94 04 601 978	F 026 003 103
95 492 971	1 987 477 082
95 492 972	1 987 477 081
95 493 016	1 987 476 756
95 493 191	0 204 123 049
95 493 192	F 026 003 046
95 493 192	0 204 123 046
95 493 193	0 204 123 047
95 494 208	F 026 003 060
95 494 208	0 204 123 060
95 494 973	1 987 476 524
95 495 125	0 204 131 255
95 495 609	0 204 123 073
95 496 106	1 987 477 077
95 496 631	F 026 003 076

95 496 631	0 204 123 076
95 496 738	F 026 002 122
95 496 738	0 204 116 122
95 534 127	0 204 116 514
95 542 783	0 986 475 233
95 542 784	0 986 475 234
95 542 785	0 986 475 231
95 555 655	0 204 123 049
95 562 403	0 204 124 039
95 568 486	0 986 475 590
95 568 492	0 204 116 035
95 569 738	F 026 002 094
95 569 738	0 204 116 094
95 569 739	F 026 002 093
95 569 739	0 204 116 093
95 571 755	0 204 123 047
95 588 899	0 204 102 036
95 588 900	0 204 102 037
95 594 171	0 204 131 126
95 594 172	0 204 131 039
95 594 173	0 204 131 259
95 595 193	F 026 003 076
95 595 193	0 204 123 076
95 599 101	1 987 476 529
95 604 194	1 987 477 485
95 606 669	F 026 002 080
95 606 669	0 204 116 080
95 607 096	0 986 471 672
95 607 097	0 986 472 672
95 608 288	0 265 200 023
95 608 289	0 265 200 023
95 608 852	F 026 002 128
95 608 852	0 204 116 128
95 608 853	F 026 002 206
95 608 853	0 204 116 206
95 608 854	F 026 002 207
95 608 854	0 204 116 207
95 609 029	0 204 131 043
95 609 790	0 986 471 776
95 609 791	0 986 471 777
95 610 344	0 265 103 009
95 610 350	0 265 001 098
95 611 063	0 204 120 018
95 611 505	1 987 477 077
95 619 547	0 986 471 885
95 619 548	0 986 471 886
95 623 221	0 986 471 778
95 623 222	0 986 471 779
95 624 920	0 986 471 672
95 624 921	0 986 472 672
95 624 922	0 204 102 593
95 624 923	0 204 102 230
95 633 277	0 204 123 034
95 637 307	0 265 001 157
95 638 095	0 265 001 158

95 644 348	F 026 003 103
95 650 933	0 986 471 885
95 650 934	0 986 471 886
95 651 048	0 204 102 245
95 651 049	0 204 102 246
95 651 050	0 204 100 125
95 651 051	0 204 104 051
95 658 555	0 986 471 659
95 658 556	0 986 472 659
95 658 573	0 986 471 885
95 658 574	0 986 471 886
95 659 474	F 026 002 230
95 659 474	0 204 116 230
95 659 475	F 026 002 231
95 659 475	0 204 116 231
95 659 534	F 026 003 243
95 659 534	0 204 122 243
95 659 583	0 265 208 321
95 659 637	0 204 102 269
95 659 638	0 204 102 270
95 659 647	0 265 208 029
95 659 664	F 026 002 131
95 659 664	0 204 116 131
95 659 665	F 026 002 132
95 659 665	0 204 116 132
95 659 668	F 026 002 180
95 659 668	0 204 116 174
95 659 673	F 026 002 222
95 659 673	0 204 116 222
95 659 674	F 026 002 223
95 659 674	0 204 116 223
95 661 913	0 986 471 885
95 661 914	0 986 471 886
95 666 799	0 204 102 277
95 666 800	0 204 102 278
95 667 768	0 204 125 134
95 667 816	0 204 102 279
95 667 817	0 204 102 280
95 667 821	0 204 100 125
95 668 067	F 026 002 234
95 668 067	0 204 116 226
95 668 067	0 204 116 234
95 668 068	F 026 002 235
95 668 069	0 986 475 636
95 668 070	0 986 475 635
95 672 052	0 204 125 715
96 000 158	0 204 123 113
96 015 069	0 204 102 241
96 015 069	0 204 102 289
96 015 070	0 204 102 242
96 015 070	0 204 102 290
96 019 357	0 204 125 060
96 026 873	1 987 477 490
96 026 875	1 987 477 491
96 032 561	1 987 477 078

96 032 564	1 987 477 323
96 032 565	1 987 477 079
96 037 065	0 261 231 034
96 037 068	0 261 231 033
96 037 346	1 987 476 796
9604 541 498	0 265 202 419
9604 541 668	0 265 216 544
96 046 511	0 204 125 080
96 046 513	0 986 485 094
96 047 310	0 204 131 046
96 054 858	0 204 125 104
96 055 917	0 204 125 102
96 071 329	0 265 003 065
96 075 932	F 026 003 142
96 075 932	0 204 123 142
96 086 319	0 265 005 111
96 087 509	0 265 003 078
96 087 509	0 265 003 128
96 087 509	0 265 006 199
96 087 996	0 265 100 073
96 089 629	0 265 003 079
96 089 629	0 265 003 129
96 089 629	0 265 006 202
96 102 107	1 987 476 729
9610 342 680	0 265 100 066
96 105 849	0 265 003 072
96 105 849	0 265 003 126
96 105 849	0 265 006 207
96 105 850	0 265 003 073
96 105 850	0 265 003 127
96 105 850	0 265 006 208
96 106 095	0 265 003 080
96 106 095	0 265 003 123
96 106 095	0 265 006 314
96 107 372	0 204 125 508
96 108 552	0 204 125 079
96 109 017	1 987 476 597
96 119 305	0 986 485 094
96 124 223	1 987 476 560
96 124 230	1 987 476 730
96 124 733	0 204 131 065
96 127 657	0 261 231 071
96 127 657	0 261 231 106
96 127 658	0 261 231 070
96 128 155	0 265 003 064
96 128 156	0 265 003 080
96 128 156	0 265 003 123
96 128 156	0 265 006 314
96 140 648	0 265 003 099
96 140 648	0 265 003 131
96 140 648	0 265 006 201
96 145 739	1 987 477 437
96 152 157	0 265 100 073
96 155 330	0 204 131 069
96 164 271	1 987 477 572

96 165 284	0 204 131 068	96 305 329	0 265 216 544	96 584 207	0 265 007 779	60 00 073 525	1 987 476 063
96 165 516	0 265 003 105	96 311 517	0 265 216 605	96 585 998	0 265 007 883	60 00 073 539	1 987 477 776
96 165 516	0 265 003 130	96 315 775	0 204 031 110	97 501 150	0 204 163 022	60 00 073 540	1 987 477 777
96 165 516	0 265 006 200	96 317 068	0 265 006 544	97 501 690	0 204 163 010	60 01 001 464	0 204 131 034
96 168 084	0 261 231 045	96 317 069	0 265 006 545	97 902 141	0 204 123 059	60 01 006 990	1 987 477 778
RENAULT							
96 176 679	1 987 477 434	96 336 665	0 265 216 643	00 00 749 155	0 204 122 041	60 01 007 399	0 204 131 042
96 180 488	0 265 003 128	96 340 455	0 265 109 415	00 13 533 600	0 204 162 018	60 01 009 148	0 204 131 047
96 180 488	0 265 006 199	96 353 847	0 265 007 423	00 16 939 800	0 204 162 022	60 01 020 682	0 265 200 036
96 181 977	0 265 006 200	96 353 848	0 265 007 424	00 17 473 700	0 204 123 022	60 01 020 718	0 332 512 010
96 181 977	0 265 006 201	96 382 908	0 265 006 659	00 17 671 900	0 204 123 469	60 01 021 402	0 265 005 004
96 181 978	0 265 006 200	96 384 235	0 261 231 128	00 25 568 000	0 204 131 032	60 01 021 402	0 265 005 041
96 181 979	0 265 006 200	96 386 487	0 265 007 423	00 30 300 000	0 204 102 211	60 01 024 042	0 204 162 103
96 181 979	0 265 006 201	96 413 154	0 265 109 432	00 30 300 100	0 204 102 642	60 01 024 043	0 204 163 024
96 183 217	0 265 006 205	96 413 162	0 265 109 089	00 55 947 714	0 204 163 105	60 01 024 812	0 265 001 311
96 183 261	0 265 006 206	96 413 162	0 265 109 414	08 55 738 800	0 204 131 002	60 01 547 168	1 987 477 955
96 190 724	1 987 477 431	96 415 250	0 265 005 253	08 55 860 900	0 204 122 015	60 01 547 169	1 987 477 956
96 190 725	1 987 477 432	96 415 250	0 265 005 290	08 55 891 200	0 204 122 015	60 01 547 632	0 986 475 837
96 209 668	0 265 208 305	96 417 091	0 265 109 415	08 55 891 200	0 204 122 015	60 01 547 819	1 987 481 032
96 210 452	0 265 005 111	96 419 753	0 265 225 128	08 70 596 200	0 204 116 474	60 01 547 858	0 986 480 852
96 217 750	0 265 006 201	96 419 842	0 204 031 181	42 72 100 32R	0 204 125 892	60 01 548 610	0 265 231 852
96 217 752	0 265 006 200	96 429 334	0 265 109 089	46 01 100 01R	0 204 123 761	60 01 548 946	0 986 480 852
96 217 753	0 265 006 202	96 431 704	0 265 006 732	47 21 000 31R	0 204 125 891	60 01 549 506	0 265 231 994
96 217 755	0 265 006 204	96 435 942	0 265 109 089	47 21 000 32R	0 204 125 892	60 01 549 506	0 265 232 111
96 217 756	0 265 006 203	96 435 942	0 265 109 414	47 21 000 33R	0 204 125 893	60 01 549 506	0 265 232 199
96 217 759	0 265 006 199	96 436 596	0 265 007 423	47 21 000 34R	0 204 125 894	60 06 000 595	1 987 477 461
96 217 763	0 265 006 207	96 436 605	0 265 007 424	47 90 000 10R	0 265 008 173	60 06 000 596	1 987 477 462
96 217 765	0 265 006 208	96 436 880	0 265 007 424	47 91 000 04R	0 265 008 172	60 06 000 701	1 987 476 701
96 218 046	0 265 006 209	96 436 977	0 265 007 423	47 91 000 07R	0 265 008 356	60 06 000 758	1 987 476 701
96 224 349	1 987 477 435	96 449 667	0 265 007 423	47 91 100 02R	0 265 008 355	60 20 013 028	0 265 215 515
96 224 350	1 987 477 432	96 449 668	0 265 007 424	47 93 000 06R	0 265 005 811	60 20 014 352	0 265 215 515
96 226 465	0 204 131 067	96 454 477	0 265 005 253	50 00 388 495	1 987 481 034	60 25 002 627	1 987 477 334
96 227 489	0 265 006 203	96 454 477	0 265 005 290	50 00 391 525	0 204 125 034	60 25 002 628	1 987 477 335
96 233 289	1 987 477 570	96 461 258	0 265 007 779	50 00 391 976	0 986 480 636	60 25 004 479	F 026 003 243
96 233 290	1 987 477 571	96 469 709	0 265 007 668	50 00 395 882	1 987 482 044	60 25 004 479	0 204 122 243
96 246 212	0 265 216 342	96 469 711	0 265 007 667	50 00 395 883	1 987 482 045	60 25 007 116	1 987 482 143
96 247 334	0 204 131 092	96 469 712	0 265 007 665	50 00 785 430	0 204 162 027	60 25 007 830	0 204 131 289
96 247 342	0 204 131 093	96 469 725	0 265 007 666	50 00 806 933	0 204 120 018	60 25 071 053	0 204 102 247
96 247 347	0 204 131 092	96 479 291	0 265 109 089	50 00 810 509	0 204 120 023	60 25 071 054	0 204 102 248
96 251 923	0 265 216 341	96 480 873	0 265 006 793	50 01 000 446	0 986 475 420	60 25 102 576	0 204 162 107
96 252 750	0 265 216 482	96 494 001	0 265 005 714	50 01 000 487	0 986 485 132	60 25 105 202	0 986 485 099
96 252 846	0 265 006 205	96 497 761	0 265 005 606	50 01 000 498	0 986 480 636	60 25 105 918	1 987 477 154
96 255 387	0 265 006 315	96 499 043	0 265 005 292	50 01 837 580	1 460 491 300	60 25 105 919	1 987 477 155
96 255 404	0 265 006 314	96 499 043	0 265 005 715	50 01 847 573	0 204 021 576	60 25 106 250	0 204 131 290
96 272 628	0 265 006 205	96 502 357	0 265 005 290	50 01 847 577	F 026 003 140	60 25 108 259	0 265 100 047
96 275 932	0 261 231 128	96 502 361	0 265 005 486	50 01 847 577	F 026 003 140	60 25 108 260	0 265 100 048
96 280 713	0 265 006 389	96 504 521	0 265 005 290	50 01 847 577	0 204 122 140	60 25 108 901	0 204 131 288
96 286 484	0 261 231 125	96 507 862	0 265 109 089	50 10 612 642	0 204 051 183	60 25 170 405	F 026 003 940
96 297 255	0 265 006 441	96 515 901	0 265 218 630	54 30 120 394	0 204 162 027	60 25 170 405	0 204 123 140
96 298 338	0 265 216 554	96 519 693	0 265 007 707	58 00 210 144	0 204 163 015	60 25 303 224	0 265 006 284
96 300 147	0 265 005 404	96 526 967	0 265 007 664	60 00 001 440	0 204 102 642	60 25 304 630	1 987 477 615
96 303 414	0 265 005 211	96 526 969	0 265 007 780	60 00 001 441	0 204 102 211	60 25 304 654	0 265 006 282
96 303 414	0 265 005 290	96 536 631	0 265 007 789	60 00 007 457	0 204 102 071	60 25 304 655	0 265 006 283
96 304 355	0 265 109 089	96 552 700	0 265 007 788	60 00 008 123	0 204 102 071	60 25 305 984	1 987 476 953
96 304 355	0 265 109 414	96 571 232	0 265 005 629	60 00 008 124	0 204 102 073	60 25 307 607	1 987 476 711
96 305 045	1 987 477 571	96 571 232	0 265 005 724	60 00 008 381	0 332 205 004	60 25 307 608	1 987 476 948

◀ RENAULT

60 25 310 456	1 987 476 916	77 00 307 718	1 987 477 664	77 00 433 238	1 987 477 783	77 00 717 331	0 986 480 635
60 25 313 181	1 987 477 616	77 00 307 719	1 987 477 666	77 00 434 097	0 265 005 417	77 00 717 549	0 265 001 071
60 25 313 182	1 987 477 616	77 00 307 720	1 987 477 663	77 00 437 993	1 987 476 920	77 00 717 550	0 265 001 069
60 25 370 467	1 987 477 615	77 00 307 721	1 987 477 665	77 00 437 994	1 987 476 919	77 00 723 014	1 987 477 664
60 25 370 468	1 987 477 616	77 00 308 909	1 987 476 699	77 00 438 266	1 987 477 890	77 00 723 015	1 987 477 666
60 25 370 495	0 986 480 921	77 00 309 823	1 987 476 905	77 00 510 747	1 987 477 277	77 00 723 303	0 986 480 916
60 25 370 660	0 265 216 312	77 00 311 216	1 987 482 012	77 00 510 748	1 987 477 276	77 00 724 410	F 026 003 078
60 25 370 827	1 987 482 144	77 00 311 217	1 987 482 013	77 00 541 132	1 987 476 493	77 00 726 005	F 026 003 103
60 25 370 908	0 265 216 727	77 00 311 698	1 987 477 632	77 00 545 267	1 987 476 146	77 00 729 504	0 204 123 088
60 25 371 686	0 265 225 184	77 00 311 699	1 987 477 633	77 00 547 099	1 987 476 145	77 00 732 030	1 987 477 465
60 25 402 447	0 265 005 416	77 00 311 700	1 987 477 634	77 00 547 538	1 987 476 130	77 00 732 031	1 987 477 665
60 25 537 467	1 987 477 615	77 00 311 701	1 987 477 635	77 00 571 639	1 987 477 463	77 00 732 032	1 987 477 663
60 25 537 468	1 987 477 616	77 00 312 835	1 987 482 042	77 00 571 640	1 987 477 464	77 00 732 756	0 204 163 027
60 40 000 691	0 265 006 711	77 00 312 990	0 204 031 111	77 00 573 569	0 204 162 035	77 00 734 129	F 026 003 257
60 40 002 862	0 265 006 744	77 00 312 990	0 204 131 387	77 00 586 233	0 204 123 009	77 00 734 129	0 204 123 257
60 40 002 893	0 265 006 745	77 00 313 058	1 987 482 043	77 00 588 892	0 204 163 027	77 00 734 633	0 204 131 139
60 40 002 895	0 265 006 746	77 00 313 511	0 204 131 388	77 00 590 483	F 026 003 012	77 00 737 184	F 026 003 031
60 40 002 896	0 265 006 747	77 00 313 681	0 265 006 528	77 00 617 297	0 204 123 013	77 00 737 184	0 204 123 031
60 40 004 524	0 265 007 529	77 00 314 792	1 987 476 955	77 00 617 708	F 026 003 019	77 00 748 059	0 265 100 047
60 40 004 524	0 265 008 327	77 00 411 745	0 265 006 384	77 00 618 661	F 026 003 019	77 00 748 444	1 987 477 662
60 40 004 527	0 265 007 528	77 00 411 746	0 265 006 385	77 00 618 662	0 204 123 013	77 00 749 185	0 265 001 242
60 40 004 542	0 265 007 583	77 00 411 747	0 265 006 383	77 00 624 692	F 026 003 019	77 00 749 186	0 265 100 048
60 40 004 543	0 265 007 582	77 00 415 353	0 204 031 329	77 00 631 756	1 987 476 466	77 00 749 188	0 265 005 038
60 40 004 808	0 265 007 534	77 00 415 681	0 265 006 383	77 00 634 179	0 204 131 021	77 00 754 882	1 987 477 156
60 40 004 809	0 265 007 533	77 00 415 682	0 265 006 384	77 00 638 947	F 026 003 012	77 00 755 370	0 265 001 070
60 40 004 810	0 265 007 532	77 00 415 683	0 265 006 385	77 00 641 119	1 987 476 146	77 00 755 371	0 265 001 068
60 40 004 811	0 265 007 531	77 00 416 273	1 987 476 917	77 00 650 845	F 026 002 080	77 00 759 586	1 987 477 280
60 40 005 449	0 265 007 606	77 00 417 967	0 265 006 363	77 00 650 845	0 204 116 080	77 00 760 876	1 987 477 280
60 40 005 449	0 265 008 293	77 00 417 968	0 265 006 361	77 00 660 977	F 026 003 026	77 00 766 098	1 987 477 332
60 40 005 450	0 265 007 607	77 00 417 969	0 265 006 362	77 00 660 977	0 204 123 026	77 00 769 840	1 987 477 333
60 40 005 450	0 265 008 294	77 00 418 730	0 204 031 295	77 00 665 654	F 026 003 031	77 00 769 842	1 987 477 469
60 40 005 494	0 265 007 597	77 00 420 047	0 204 031 314	77 00 665 654	0 204 123 031	77 00 770 689	0 204 163 025
74 20 784 644	0 204 051 074	77 00 420 314	1 987 477 636	77 00 666 324	F 026 003 032	77 00 772 309	0 265 001 069
77 00 076 971	1 987 476 244	77 00 421 024	1 987 477 637	77 00 666 324	0 204 123 032	77 00 772 310	0 265 001 068
77 00 271 090	0 261 231 006	77 00 421 068	0 265 006 442	77 00 666 325	F 026 003 033	77 00 777 520	1 987 477 470
77 00 272 242	0 265 006 735	77 00 421 069	0 265 006 443	77 00 666 325	0 204 123 033	77 00 781 393	1 987 477 311
77 00 272 243	0 265 006 737	77 00 421 070	0 265 006 444	77 00 667 653	0 204 162 024	77 00 781 394	1 987 477 471
77 00 272 244	0 265 006 736	77 00 422 532	1 987 477 638	77 00 668 029	0 204 131 025	77 00 785 481	0 204 162 037
77 00 272 269	0 265 208 337	77 00 423 975	1 987 476 859	77 00 668 132	1 987 476 466	77 00 787 630	F 026 003 180
77 00 301 248	0 204 031 307	77 00 424 468	1 987 477 639	77 00 676 965	1 987 476 461	77 00 787 630	0 204 123 180
77 00 301 311	0 265 006 400	77 00 424 469	1 987 477 640	77 00 676 967	1 987 476 688	77 00 787 634	F 026 003 103
77 00 301 312	0 265 006 401	77 00 424 470	1 987 477 475	77 00 676 971	1 987 476 244	77 00 788 371	0 204 131 283
77 00 301 315	0 265 006 386	77 00 424 472	1 987 477 636	77 00 678 528	0 204 123 050	77 00 788 372	0 204 131 051
77 00 301 316	0 265 006 387	77 00 424 923	1 987 477 781	77 00 681 968	1 987 476 688	77 00 789 364	0 204 125 061
77 00 301 730	0 204 031 306	77 00 424 926	1 987 477 641	77 00 685 063	0 986 482 002	77 00 793 558	F 026 003 180
77 00 301 730	0 204 131 299	77 00 424 928	1 987 477 642	77 00 685 455	0 204 131 030	77 00 793 558	0 204 123 180
77 00 302 380	1 987 476 906	77 00 424 929	1 987 477 643	77 00 685 456	0 204 131 029	77 00 795 275	0 986 480 913
77 00 304 968	1 987 476 955	77 00 425 846	0 204 022 806	77 00 694 069	F 026 003 033	77 00 799 541	0 986 480 916
77 00 304 969	1 987 476 956	77 00 425 846	0 204 031 296	77 00 694 069	0 204 123 033	77 00 802 685	1 987 477 152
77 00 305 115	0 265 006 157	77 00 426 005	1 987 477 644	77 00 701 834	0 986 480 902	77 00 802 686	1 987 477 153
77 00 305 116	0 265 006 156	77 00 426 006	1 987 477 645	77 00 701 835	0 204 123 062	77 00 804 076	0 986 480 774
77 00 305 117	0 265 006 155	77 00 427 498	1 987 477 646	77 00 707 146	0 986 480 913	77 00 804 356	1 987 476 421
77 00 305 118	0 265 006 154	77 00 432 012	1 987 477 647	77 00 716 678	0 204 131 040	77 00 804 376	0 204 131 147
77 00 305 119	0 265 105 038	77 00 432 013	1 987 477 937	77 00 716 683	0 204 125 040	77 00 804 377	0 204 131 146
77 00 307 717	1 987 477 662	77 00 433 238	1 987 477 782	77 00 717 111	0 265 201 010	77 00 804 814	1 987 476 557

77 00 804 898	0 204 123 357
77 00 806 172	0 265 003 067
77 00 806 172	0 265 006 442
77 00 806 173	0 265 003 069
77 00 806 173	0 265 006 443
77 00 806 174	0 265 003 068
77 00 806 174	0 265 006 444
77 00 807 607	0 265 003 067
77 00 807 608	0 265 003 068
77 00 807 609	0 265 003 069
77 00 808 487	0 204 131 149
77 00 808 488	0 204 131 150
77 00 808 489	0 204 131 151
77 00 808 990	0 204 125 090
77 00 810 580	0 204 131 153
77 00 810 581	0 204 131 154
77 00 810 688	0 265 003 082
77 00 810 688	0 265 006 361
77 00 810 689	0 265 003 083
77 00 810 689	0 265 006 362
77 00 810 690	0 265 003 084
77 00 810 690	0 265 006 363
77 00 810 982	0 204 131 062
77 00 810 983	0 204 131 063
77 00 810 985	0 986 480 642
77 00 811 234	0 204 131 284
77 00 811 704	1 987 476 598
77 00 811 705	1 987 476 700
77 00 812 524	1 987 477 648
77 00 812 525	1 987 477 649
77 00 813 901	0 204 125 092
77 00 815 767	0 265 005 111
77 00 816 858	1 987 477 311
77 00 816 976	0 265 100 067
77 00 817 087	0 204 131 162
77 00 817 136	1 987 477 471
77 00 818 498	0 204 131 164
77 00 819 268	0 265 208 028
77 00 820 232	F 026 003 151
77 00 820 232	0 204 123 151
77 00 822 149	0 204 131 165
77 00 822 150	0 204 131 166
77 00 822 151	0 204 131 167
77 00 822 153	0 204 131 168
77 00 823 689	1 987 477 472
77 00 823 690	1 987 477 473
77 00 824 736	1 987 476 421
77 00 828 918	0 204 125 111
77 00 829 237	0 204 131 175
77 00 829 238	0 204 131 176
77 00 829 805	0 204 125 115
77 00 830 223	0 332 512 010
77 00 830 864	0 204 131 178
77 00 832 611	1 987 476 424
77 00 832 859	0 204 131 177

77 00 834 651	1 987 477 475
77 00 834 652	1 987 477 781
77 00 834 655	1 987 477 639
77 00 834 731	1 987 476 701
77 00 834 863	1 987 476 702
77 00 834 990	1 987 476 703
77 00 838 154	0 204 131 188
77 00 838 158	0 204 131 188
77 00 840 370	0 204 031 311
77 00 840 371	0 204 031 313
77 00 840 372	0 204 031 312
77 00 840 373	0 204 031 314
77 00 840 375	0 204 031 313
77 00 840 390	1 987 476 704
77 00 841 026	1 987 477 650
77 00 842 116	0 204 131 183
77 00 843 028	0 204 131 185
77 00 845 039	0 204 131 094
77 00 845 040	0 204 131 095
77 00 845 510	1 987 476 705
77 00 846 155	1 987 477 640
77 00 846 156	1 987 477 636
77 00 850 071	0 332 512 010
77 00 871 678	0 261 231 046
77 01 000 116	0 204 122 016
77 01 000 239	1 987 476 145
77 01 003 237	0 204 122 013
77 01 005 966	0 204 122 011
77 01 007 119	0 204 122 042
77 01 009 039	0 204 104 090
77 01 012 570	0 204 102 642
77 01 017 997	0 986 475 232
77 01 020 059	0 986 475 393
77 01 020 062	0 204 116 509
77 01 020 062	0 986 475 394
77 01 020 244	0 986 471 780
77 01 020 245	0 986 471 781
77 01 024 247	F 026 002 060
77 01 024 248	F 026 002 061
77 01 024 260	0 986 475 232
77 01 024 263	0 986 475 393
77 01 024 264	0 204 116 509
77 01 024 264	0 986 475 394
77 01 024 265	0 986 475 233
77 01 024 266	0 986 475 234
77 01 025 172	F 026 002 164
77 01 025 932	0 986 475 458
77 01 025 933	F 026 002 163
77 01 025 933	0 204 116 098
77 01 025 933	0 986 475 458
77 01 026 030	0 986 480 902
77 01 026 031	0 986 480 913
77 01 026 367	F 026 002 177
77 01 026 367	0 204 116 177
77 01 026 618	F 026 002 087

77 01 026 618	0 204 116 087
77 01 026 618	0 986 475 209
77 01 027 057	0 986 480 636
77 01 027 198	F 026 002 177
77 01 027 198	0 204 116 177
77 01 027 199	F 026 002 176
77 01 027 199	0 204 116 176
77 01 028 250	0 986 475 788
77 01 028 251	0 986 475 789
77 01 030 012	F 026 002 176
77 01 030 012	0 204 116 117
77 01 030 155	0 986 475 051
77 01 031 504	F 026 002 176
77 01 031 504	0 204 116 176
77 01 031 505	F 026 002 177
77 01 031 505	0 204 116 177
77 01 032 318	0 986 475 053
77 01 032 319	0 986 475 054
77 01 032 339	F 026 002 139
77 01 032 339	0 204 116 139
77 01 032 340	F 026 002 140
77 01 032 340	0 204 116 140
77 01 032 924	F 026 002 210
77 01 032 924	0 204 116 210
77 01 032 925	F 026 002 211
77 01 032 925	0 204 116 211
77 01 033 007	F 026 002 135
77 01 033 007	0 204 116 135
77 01 033 008	F 026 002 136
77 01 033 008	0 204 116 136
77 01 033 311	0 204 116 212
77 01 033 312	F 026 002 232
77 01 033 312	0 204 116 232
77 01 033 390	F 026 002 237
77 01 033 390	0 204 116 237
77 01 033 391	F 026 002 236
77 01 033 391	0 204 116 236
77 01 033 548	0 204 116 159
77 01 033 599	0 986 475 643
77 01 033 600	0 986 475 644
77 01 033 707	0 986 475 637
77 01 034 118	F 026 002 133
77 01 034 118	0 204 116 133
77 01 034 119	F 026 002 134
77 01 034 119	0 204 116 134
77 01 034 172	F 026 002 164
77 01 034 172	0 204 116 164
77 01 034 173	F 026 002 163
77 01 034 173	0 204 116 163
77 01 034 549	0 986 480 913
77 01 035 226	0 265 208 304
77 01 035 310	F 026 002 237
77 01 035 310	0 204 116 237
77 01 035 311	F 026 002 236
77 01 035 311	0 204 116 236

77 01 035 405	0 986 475 642
77 01 035 406	0 986 475 641
77 01 035 464	0 986 475 644
77 01 035 465	0 986 475 643
77 01 035 467	F 026 002 232
77 01 035 467	0 204 116 232
77 01 035 468	F 026 002 233
77 01 035 468	0 204 116 233
77 01 035 471	F 026 002 234
77 01 035 471	0 204 116 226
77 01 035 471	0 204 116 234
77 01 035 472	F 026 002 235
77 01 035 473	F 026 002 234
77 01 035 473	0 204 116 226
77 01 035 474	F 026 002 235
77 01 035 475	F 026 002 176
77 01 035 475	0 204 116 176
77 01 035 476	F 026 002 177
77 01 035 476	0 204 116 177
77 01 035 477	0 986 475 677
77 01 036 006	F 026 002 131
77 01 036 006	0 204 116 131
77 01 036 007	F 026 002 132
77 01 036 007	0 204 116 132
77 01 036 123	0 265 208 308
77 01 036 138	0 265 201 060
77 01 037 187	0 265 208 337
77 01 038 287	0 986 475 765
77 01 039 388	F 026 002 238
77 01 039 388	0 204 116 238
77 01 039 389	F 026 002 239
77 01 039 389	0 204 116 239
77 01 039 390	F 026 002 232
77 01 039 390	0 204 116 232
77 01 039 391	F 026 002 233
77 01 039 391	0 204 116 233
77 01 039 392	F 026 002 234
77 01 039 392	0 204 116 234
77 01 039 393	F 026 002 235
77 01 039 393	0 204 116 235
77 01 039 394	F 026 002 236
77 01 039 394	0 204 116 236
77 01 039 395	F 026 002 237
77 01 039 395	0 204 116 237
77 01 039 467	F 026 002 180
77 01 039 467	0 204 116 180
77 01 039 522	0 265 201 075
77 01 040 850	F 026 002 182
77 01 040 850	0 204 116 182
77 01 041 021	0 986 475 797
77 01 042 416	0 986 475 868
77 01 042 514	0 265 216 488
77 01 043 728	0 265 216 556
77 01 043 775	0 265 216 609
77 01 043 789	0 986 475 834



◀ RENAULT

77 01 043 790	0 986 475 835	77 01 062 932	0 265 231 735	77 01 202 039	0 204 102 054	77 01 204 847	0 204 102 184
77 01 043 912	F 026 002 482	77 01 063 640	0 265 234 501	77 01 202 042	0 204 102 631	77 01 204 857	0 204 125 153
77 01 043 912	0 204 116 482	77 01 063 861	0 265 234 469	77 01 202 043	0 204 102 662	77 01 204 858	0 204 125 161
77 01 043 913	F 026 002 483	77 01 063 867	0 265 234 469	77 01 202 046	0 986 471 784	77 01 204 890	0 204 125 119
77 01 043 913	0 204 116 483	77 01 063 868	0 265 234 471	77 01 202 047	0 986 471 785	77 01 204 916	0 204 125 533
77 01 043 934	0 265 216 627	77 01 063 868	0 265 234 473	77 01 202 142	0 204 102 075	77 01 204 918	F 026 003 243
77 01 044 556	1 460 491 300	77 01 063 868	0 265 234 680	77 01 202 143	0 204 102 077	77 01 204 965	0 204 125 166
77 01 044 602	F 026 002 532	77 01 063 870	0 265 234 466	77 01 202 145	0 204 104 068	77 01 204 968	0 204 125 170
77 01 044 602	0 204 116 532	77 01 063 870	0 265 234 467	77 01 202 206	0 204 102 083	77 01 205 094	F 026 003 103
77 01 044 603	0 204 116 533	77 01 063 871	0 265 234 467	77 01 202 207	0 204 102 085	77 01 205 199	0 204 125 526
77 01 044 681	0 986 475 837	77 01 063 911	0 265 231 803	77 01 202 218	0 204 100 083	77 01 205 206	0 204 125 528
77 01 044 850	F 026 002 480	77 01 063 912	0 265 231 805	77 01 202 243	0 986 472 671	77 01 205 207	0 204 125 527
77 01 044 850	0 204 116 480	77 01 063 912	0 265 232 078	77 01 202 476	0 204 100 096	77 01 205 213	F 026 003 184
77 01 044 882	0 265 216 635	77 01 064 989	0 265 234 511	77 01 202 478	0 204 102 252	77 01 205 213	0 204 123 184
77 01 045 830	0 265 216 679	77 01 065 814	0 265 234 473	77 01 202 786	0 204 102 243	77 01 205 286	0 204 123 651
77 01 045 832	0 265 216 681	77 01 065 814	0 265 234 680	77 01 202 787	0 204 102 244	77 01 205 287	0 204 125 578
77 01 046 156	0 265 220 545	77 01 066 021	0 265 234 158	77 01 202 985	0 204 102 249	77 01 205 288	0 204 123 409
77 01 046 407	0 265 216 703	77 01 069 217	0 265 234 680	77 01 202 986	0 204 102 250	77 01 205 295	0 986 480 908
77 01 047 236	F 026 002 564	77 01 070 668	0 204 116 480	77 01 202 987	0 204 100 127	77 01 205 405	0 204 123 371
77 01 047 236	0 204 116 564	77 01 200 006	0 204 102 664	77 01 203 032	0 204 102 252	77 01 205 407	0 204 123 372
77 01 047 249	0 265 216 741	77 01 200 007	0 204 102 663	77 01 203 073	0 204 102 251	77 01 205 484	0 204 123 155
77 01 047 568	0 265 216 768	77 01 200 592	0 204 104 219	77 01 203 074	0 204 102 252	77 01 205 737	0 204 123 415
77 01 047 838	0 204 011 249	77 01 200 699	0 204 104 038	77 01 203 275	F 026 003 101	77 01 205 739	0 204 123 416
77 01 048 302	0 265 220 601	77 01 201 090	0 204 102 021	77 01 203 275	0 204 123 101	77 01 205 740	0 204 123 418
77 01 050 006	0 265 225 108	77 01 201 091	0 204 102 023	77 01 203 276	F 026 003 031	77 01 205 741	0 204 0A2 184
77 01 050 070	1 987 476 999	77 01 201 108	0 204 102 662	77 01 203 276	0 204 123 031	77 01 205 741	0 204 125 733
77 01 050 071	0 265 225 110	77 01 201 109	0 204 102 654	77 01 203 277	0 204 123 072	77 01 205 784	F 026 003 410
77 01 050 073	1 987 476 044	77 01 201 140	0 204 102 056	77 01 203 659	0 986 471 786	77 01 205 784	0 204 123 410
77 01 050 114	0 204 162 146	77 01 201 141	0 204 102 058	77 01 203 660	0 986 471 787	77 01 205 785	0 204 125 579
77 01 050 128	0 265 216 881	77 01 201 149	0 204 102 089	77 01 203 661	0 986 471 788	77 01 205 786	0 204 125 580
77 01 050 132	0 265 216 873	77 01 201 150	0 204 100 387	77 01 203 662	0 986 471 789	77 01 205 815	0 986 480 984
77 01 050 906	0 986 480 887	77 01 201 152	0 204 102 087	77 01 203 664	0 204 102 261	77 01 205 931	0 986 480 830
77 01 050 907	0 986 480 887	77 01 201 168	0 986 471 780	77 01 203 665	0 204 102 262	77 01 206 229	0 986 480 977
77 01 050 908	0 986 480 831	77 01 201 169	0 986 471 781	77 01 203 718	0 204 123 138	77 01 206 231	0 986 480 851
77 01 050 909	0 986 480 831	77 01 201 239	0 204 102 027	77 01 203 719	F 026 003 940	77 01 206 425	0 204 125 733
77 01 052 131	0 265 220 669	77 01 201 240	0 204 102 029	77 01 203 719	0 204 123 140	77 01 206 725	0 204 102 969
77 01 052 726	0 265 216 954	77 01 201 664	0 986 471 665	77 01 203 844	0 204 102 285	77 01 206 726	0 204 102 970
77 01 052 727	0 265 216 956	77 01 201 665	0 986 472 665	77 01 203 845	0 204 102 286	77 01 206 754	0 204 004 320
77 01 054 239	0 265 225 214	77 01 201 673	0 204 120 023	77 01 203 975	0 986 471 790	77 01 206 755	0 204 004 321
77 01 054 239	0 265 225 260	77 01 201 769	0 986 471 671	77 01 203 976	0 986 471 791	77 01 206 755	0 204 102 968
77 01 054 589	0 265 231 360	77 01 201 770	0 986 472 671	77 01 204 103	0 204 123 155	77 01 206 792	0 986 480 977
77 01 054 589	0 265 231 803	77 01 201 777	0 204 102 033	77 01 204 110	0 986 480 955	77 01 206 805	0 204 125 771
77 01 054 590	0 265 234 076	77 01 201 778	0 204 102 035	77 01 204 112	0 986 480 908	77 01 206 806	0 204 125 770
77 01 055 398	0 265 231 334	77 01 201 793	0 204 120 018	77 01 204 590	1 987 476 598	77 01 206 898	0 986 480 888
77 01 055 716	0 265 231 376	77 01 201 877	0 204 102 039	77 01 204 605	F 026 003 243	77 01 207 077	0 204 125 782
77 01 056 094	0 265 225 260	77 01 201 878	0 204 102 041	77 01 204 606	0 986 485 106	77 01 207 078	0 204 125 796
77 01 057 881	0 265 231 517	77 01 201 879	0 204 104 066	77 01 204 608	F 026 003 180	77 01 207 150	0 204 102 995
77 01 057 881	0 265 231 805	77 01 201 965	0 986 471 677	77 01 204 608	0 204 123 180	77 01 207 157	0 204 104 272
77 01 057 881	0 265 232 078	77 01 201 966	0 986 472 677	77 01 204 609	0 204 123 176	77 01 207 158	0 204 104 261
77 01 059 138	0 265 231 489	77 01 202 004	0 204 120 023	77 01 204 610	0 204 123 678	77 01 207 198	0 204 123 589
77 01 059 138	0 265 231 852	77 01 202 013	0 204 102 065	77 01 204 611	0 204 125 149	77 01 207 199	0 204 125 786
77 01 059 250	0 265 231 578	77 01 202 014	0 204 102 067	77 01 204 612	0 204 125 151	77 01 207 200	0 204 125 787
77 01 062 137	0 265 234 311	77 01 202 034	0 204 102 069	77 01 204 721	0 204 125 146	77 01 207 472	0 204 125 788
77 01 062 187	0 265 234 309	77 01 202 035	0 204 102 633	77 01 204 722	0 204 125 155	77 01 207 473	0 204 123 590
77 01 062 187	0 265 234 511	77 01 202 038	0 204 102 052	77 01 204 846	0 204 102 182	77 01 207 477	0 204 004 175



77 01 207 478	0 204 004 176
77 01 207 481	0 204 104 284
77 01 207 659	0 204 125 794
77 01 207 679	0 204 004 346
77 01 207 680	0 204 004 347
77 01 207 685	0 204 004 342
77 01 207 685	0 204 205 126
77 01 207 686	0 204 004 343
77 01 207 686	0 204 205 127
77 01 207 755	0 204 125 795
77 01 207 756	0 204 125 796
77 01 207 769	0 204 125 802
77 01 207 786	0 204 001 935
77 01 207 787	0 204 001 936
77 01 207 978	0 204 125 811
77 01 207 979	0 204 123 634
77 01 208 012	0 204 004 237
77 01 208 013	0 204 004 238
77 01 208 036	0 204 004 173
77 01 208 036	0 204 004 320
77 01 208 037	0 204 004 174
77 01 208 037	0 204 004 321
77 01 208 175	0 204 125 819
77 01 208 176	0 204 123 651
77 01 208 266	0 986 480 828
77 01 208 355	0 986 475 934
77 01 208 398	0 986 480 886
77 01 208 484	0 265 234 158
77 01 208 493	0 986 480 827
77 01 208 583	0 204 123 763
77 01 209 220	0 204 123 726
77 01 209 498	0 265 234 619
77 01 209 583	0 204 123 763
77 01 209 606	0 265 232 078
77 01 209 764	0 204 123 759
77 01 348 206	F 026 003 019
77 01 348 207	1 987 476 707
77 01 348 267	1 987 477 477
77 01 348 269	1 987 477 478
77 01 348 316	1 987 477 463
77 01 348 350	0 204 131 021
77 01 348 483	0 204 122 042
77 01 348 487	1 987 477 034
77 01 348 726	F 026 003 026
77 01 348 726	0 204 123 026
77 01 348 758	1 987 476 130
77 01 348 781	1 987 477 464
77 01 348 799	1 987 476 145
77 01 348 800	1 987 476 146
77 01 348 812	0 204 125 028
77 01 348 813	0 204 131 121
77 01 348 912	1 987 476 466
77 01 348 920	1 987 476 706
77 01 348 924	F 026 003 012
77 01 349 053	0 204 131 371

77 01 349 122	F 026 002 177
77 01 349 122	0 204 116 177
77 01 349 123	F 026 002 176
77 01 349 123	0 204 116 176
77 01 349 127	1 987 476 244
77 01 349 150	F 026 002 109
77 01 349 150	0 204 116 109
77 01 349 152	0 204 123 050
77 01 349 254	F 026 003 033
77 01 349 254	0 204 123 033
77 01 349 304	1 987 476 518
77 01 349 306	0 204 131 028
77 01 349 337	1 987 476 688
77 01 349 350	0 204 125 038
77 01 349 409	0 204 131 025
77 01 349 441	0 204 125 018
77 01 349 451	0 204 125 041
77 01 349 537	0 204 123 013
77 01 349 545	F 026 003 032
77 01 349 545	0 204 123 032
77 01 349 719	0 204 125 049
77 01 349 720	0 204 125 047
77 01 349 735	0 204 131 140
77 01 349 762	F 026 003 103
77 01 349 781	0 204 125 055
77 01 349 787	0 204 131 139
77 01 349 788	0 204 131 040
77 01 349 871	F 026 003 243
77 01 349 871	0 204 122 243
77 01 365 033	F 026 002 109
77 01 365 033	0 204 116 109
77 01 365 272	0 204 123 353
77 01 365 284	0 204 122 033
77 01 365 330	1 987 476 145
77 01 365 340	0 204 122 042
77 01 365 375	0 204 116 071
77 01 365 376	0 204 116 072
77 01 365 377	F 026 002 073
77 01 365 377	0 204 116 073
77 01 365 379	F 026 002 109
77 01 365 379	0 204 116 109
77 01 365 382	F 026 002 075
77 01 365 382	0 204 116 075
77 01 365 383	F 026 002 074
77 01 365 383	0 204 116 074
77 01 365 405	0 986 475 233
77 01 365 406	0 986 475 234
77 01 365 424	1 987 476 465
77 01 365 427	1 987 476 707
77 01 365 465	F 026 002 176
77 01 365 465	0 204 116 176
77 01 365 466	F 026 002 177
77 01 365 466	0 204 116 177
77 01 365 516	1 987 476 706
77 01 365 519	F 026 002 080

77 01 365 519	0 204 116 080
77 01 365 840	0 986 475 420
77 01 454 063	1 987 476 130
77 01 454 836	1 987 476 146
77 01 582 523	1 987 476 145
77 02 107 726	0 204 131 110
77 02 109 362	0 204 123 236
77 02 145 667	F 026 003 257
77 02 145 667	0 204 123 257
77 03 033 311	F 026 002 233
77 03 033 311	0 204 116 233
77 04 001 610	1 987 477 280
77 04 001 811	1 987 477 034
77 04 001 925	1 987 476 146
77 04 001 930	1 987 476 466
77 04 001 933	1 987 476 494
77 04 001 934	1 987 476 494
77 04 001 935	1 987 476 707
77 04 001 936	1 987 476 707
77 04 001 943	1 987 476 150
77 04 001 947	1 987 476 461
77 04 001 948	1 987 476 461
77 04 001 950	1 987 476 493
77 04 001 951	1 987 476 708
77 04 001 952	1 987 476 432
77 04 001 953	1 987 476 432
77 04 001 954	1 987 476 518
77 04 001 955	1 987 476 700
77 04 001 956	1 987 476 492
77 04 002 443	1 987 476 709
77 04 002 444	1 987 476 492
77 04 002 447	1 987 476 700
77 04 002 450	1 987 476 432
77 04 003 549	1 987 476 493
77 04 003 764	1 987 476 710
77 04 003 765	1 987 476 517
77 04 003 846	1 987 476 535
77 04 003 887	1 987 476 421
77 04 003 905	1 987 476 517
77 04 003 913	1 987 476 699
77 04 003 922	1 987 476 557
77 04 003 949	1 987 476 421
77 04 003 955	1 987 476 432
77 04 003 957	1 987 476 711
77 04 003 958	1 987 476 948
77 04 003 959	1 987 476 032
77 04 003 961	1 987 476 712
77 11 152 346	0 204 125 166
79 10 025 031	F 026 005 517
82 00 002 236	1 987 477 652
82 00 003 478	1 987 476 700
82 00 003 480	1 987 476 914
82 00 008 472	1 987 482 146
82 00 008 473	1 987 482 145
82 00 019 096	1 987 476 701

82 00 020 558	1 987 476 517
82 00 021 935	1 987 482 012
82 00 021 940	1 987 477 261
82 00 023 291	0 204 031 115
82 00 026 737	0 265 005 417
82 00 026 739	0 265 005 263
82 00 026 739	0 265 005 264
82 00 029 461	1 987 477 653
82 00 035 047	1 987 477 654
82 00 042 064	1 987 482 142
82 00 042 065	1 987 482 142
82 00 045 573	1 987 476 711
82 00 052 863	1 987 476 702
82 00 057 460	1 987 481 150
82 00 057 986	0 204 031 164
82 00 057 986	0 204 031 308
82 00 057 998	0 204 031 309
82 00 058 186	0 265 006 710
82 00 058 187	0 265 006 711
82 00 058 207	1 987 476 064
82 00 058 609	1 987 476 918
82 00 058 949	1 987 476 065
82 00 062 202	1 987 476 067
82 00 069 837	0 204 031 309
82 00 074 266	0 265 005 263
82 00 086 894	1 987 481 152
82 00 087 977	1 987 477 782
82 00 087 979	1 987 477 783
82 00 087 981	1 987 477 784
82 00 087 982	1 987 477 785
82 00 106 247	0 265 231 301
82 00 106 247	0 265 231 735
82 00 107 241	0 265 234 001
82 00 107 241	0 265 234 139
82 00 107 241	0 265 234 311
82 00 116 460	0 204 031 310
82 00 116 460	0 204 131 391
82 00 116 461	0 204 031 309
82 00 116 463	0 204 031 164
82 00 116 463	0 204 031 308
82 00 116 463	0 204 131 389
82 00 120 636	0 265 005 441
82 00 129 954	1 987 476 827
82 00 131 598	1 987 476 421
82 00 131 599	1 987 476 703
82 00 173 959	0 265 006 746
82 00 173 960	0 265 006 747
82 00 173 963	0 265 006 744
82 00 173 966	0 265 006 745
82 00 178 389	1 987 477 137
82 00 178 390	1 987 477 116
82 00 186 294	0 265 007 527
82 00 186 298	0 265 007 535
82 00 186 299	0 265 007 536
82 00 195 825	0 265 007 596



◀ RENAULT

82 00 195 825	0 265 007 742
82 00 195 828	0 265 007 606
82 00 195 828	0 265 008 293
82 00 195 830	0 265 007 607
82 00 195 830	0 265 008 294

82 00 195 832	0 265 007 527
82 00 195 832	0 265 007 597
82 00 212 693	0 265 007 534
82 00 212 695	0 265 007 532
82 00 212 696	0 265 007 533

82 00 212 698	0 265 007 531
82 00 214 750	1 987 477 967
82 00 214 752	1 987 477 938
82 00 228 260	1 987 482 040
82 00 228 347	1 987 482 041

82 00 229 445	1 987 477 787
82 00 234 737	1 987 476 126
82 00 243 673	1 987 477 787
82 00 245 920	1 987 476 032
82 00 247 041	1 987 477 786

82 00 247 042	1 987 482 011
82 00 247 043	1 987 477 787
82 00 249 251	1 987 476 956
82 00 253 905	1 987 477 652
82 00 254 681	0 265 008 327

82 00 254 687	0 265 007 583
82 00 254 688	0 265 007 582
82 00 256 166	1 987 476 068
82 00 269 348	1 987 477 939
82 00 269 350	1 987 477 940

82 00 270 181	1 987 477 963
82 00 270 182	1 987 477 964
82 00 298 383	1 987 477 965
82 00 298 384	1 987 477 966
82 00 300 204	0 265 234 129

82 00 300 204	0 265 234 466
82 00 333 851	1 987 476 126
82 00 355 248	0 265 234 139
82 00 355 248	0 265 234 311
82 00 355 249	0 265 231 475

82 00 355 249	0 265 231 735
82 00 403 898	0 204 131 718
82 00 404 264	1 987 481 165
82 00 419 177	0 265 007 742
82 00 440 544	0 265 007 809

82 00 440 551	0 265 007 810
82 00 440 561	0 265 007 811
82 00 441 401	0 265 007 936
82 00 441 403	0 265 007 937
82 00 441 404	0 265 007 938

82 00 441 620	0 265 007 939
82 00 441 622	0 265 007 940
82 00 457 357	0 265 008 295
82 00 457 358	0 265 008 296
82 00 485 061	0 265 005 701

82 00 572 102	1 987 476 711
82 00 583 498	0 265 008 077
82 00 597 210	1 987 476 827
82 00 667 750	1 987 481 152
82 00 673 551	1 987 481 150

82 00 673 552	1 987 481 151
82 00 673 567	1 987 481 186
82 00 675 748	0 265 008 041
82 00 675 755	0 265 008 042
82 00 687 499	0 204 131 299

82 00 687 507	0 204 031 111
82 00 688 042	1 987 481 165
82 00 692 201	0 204 131 330
82 00 694 022	1 987 482 142
82 00 694 080	1 987 477 634

82 00 694 083	1 987 477 635
82 00 698 379	0 204 031 309
82 00 724 127	0 265 008 078
82 00 729 948	0 204 031 164
82 00 729 948	0 204 031 308

82 00 752 604	0 265 008 297
82 00 752 604	0 265 008 298
82 00 752 605	0 265 008 297
82 00 752 605	0 265 008 298
82 00 804 554	0 265 005 416

82 00 882 051	0 204 131 299
82 00 882 054	0 204 031 111
82 00 882 876	0 204 131 330
82 00 882 879	0 204 131 177
82 00 882 881	0 204 131 280

82 00 882 882	0 204 131 091
82 00 883 928	0 204 031 309
82 00 883 930	0 204 031 164
82 00 883 930	0 204 031 308
82 00 933 549	0 265 008 393

85 57 388 000	0 204 131 002
85 57 388 001	0 204 131 002
85 58 609 000	0 204 122 015
85 58 609 001	0 204 122 015
87 05 962 000	0 204 116 474

87 05 962 001	0 204 116 474
96 12 765 880	0 261 231 070
96 28 648 480	0 261 231 125

SEAT	
HB1 673 580 0	1 987 477 083
RF7 200 020 0	F 026 002 470
RF7 200 020 0	0 204 116 470

SE 021 715 003 A	F 026 003 180
SE 021 715 003 A	0 204 123 180
SE021720001A	F 026 002 470
SE021720001A	0 204 116 470
SE021744400A	1 987 476 739

SE022165005A	0 204 102 447
SE022165006A	0 204 102 448
SE 022 715 003 A	F 026 003 180
SE 022 715 003 A	0 204 123 180
SE 022 744 400 A	1 987 476 442

SE 022 744 400 C	1 987 476 442
SE024167358A	1 987 477 792
SE0 257 200 2A	F 026 002 454
SE0 257 200 2A	F 026 002 565
SE0 257 200 2A	0 204 116 454

SE0 257 200 2A	0 204 116 565
SE0 287 200 1A	F 026 002 454
SE0 287 200 1A	F 026 002 565
SE0 287 200 1A	0 204 116 454
SE0 287 200 1A	0 204 116 565

SE138715004A	0 204 122 230
SE141167358A	1 987 477 086
SE 141 744 400 B	1 987 476 239
SE141744400D	1 987 476 240
XO4406021	1 987 477 086

XO 5957947	1 987 476 503
X 044 777 93	1 987 476 244
000 079 004 9	0 986 475 273
000 389 976 4	F 026 002 454
000 389 976 4	F 026 002 565

000 389 976 4	0 204 116 454
000 389 976 4	0 204 116 565
000 396 325 3	F 026 002 454
000 396 325 3	F 026 002 565
000 396 325 3	0 204 116 454

000 396 325 3	0 204 116 565
000 396 423 5	0 204 131 141
000 396 722 6	0 204 116 403
000 396 722 7	0 204 116 402
000 398 133 6	F 026 003 180

000 398 133 6	0 204 123 180
029 753 004 A	0 204 131 717
1H0 611 775	1 987 476 400
1H0 612 151 C	0 204 131 697
1H0 612 151 D	0 204 131 310

1H0 612 151 E	0 204 131 697
1H0 615 123 A	0 986 471 663
1H0 615 124 A	0 986 472 663
1H1 611 019 A	F 026 003 562
1H1 611 019 A	0 204 123 562

1H1 611 019 C	F 026 003 562
1H1 611 019 C	0 204 123 562
1J1 614 019	0 204 123 339
1L0 612 107 A	0 204 125 243
1L0 612 107 A	0 986 485 107

171 615 124 B	0 986 472 663
191 611 019	F 026 003 180
191 611 019	0 204 123 180
191 612 151	0 986 482 006
191 612 151 C	0 986 482 006

191 615 123	0 204 102 940
191 615 124	0 204 102 374
251 611 021 K	0 986 480 641
331 698 051 A	0 986 475 260
357 611 019	F 026 003 562

357 611 019	0 204 123 562
357 612 107	0 986 485 107
3943399	1 987 476 442
437 611 775	1 987 476 230
6K1 612 107 G	0 204 125 262

6K2 611 019	0 204 123 521
6K2 611 019 C	0 204 123 521
6K2 612 107 F	0 204 125 264
6K2 612 107 H	0 204 024 057
6K2 698 019 A	0 204 123 520

6K9 611 776	1 987 476 169
6K9 612 151	0 204 031 290
6K9 612 151	0 204 131 363
6N0 609 721 L	1 987 477 627
6N0 611 701	1 987 476 696

6N0 611 701 A	1 987 476 696
6N0 611 701 B	1 987 476 696
6N0 611 775 A	1 987 476 697
6N1 612 107 B	0 204 125 254
7M0 611 701 D	1 987 476 713

7M0 611 775 E	1 987 476 714
7M0 611 776 B	1 987 476 715
7M0 611 776 C	1 987 476 715
7M0 615 424	0 986 471 847
701 611 701 A	1 987 476 698

701 612 503	0 204 031 292
701 612 503 A	0 204 031 292
701 612 503 C	0 204 031 292
8D0 611 707 B	1 987 476 717
8E0 611 775 B	1 987 476 719

8E0 611 775 E	1 987 476 719
867 612 107	0 204 125 054
868 611 019	0 204 123 329
9360384	1 987 476 442

SKODA	
007 486 201 F	0 986 480 682
1J0 609 721 D	1 987 477 704
1J0 609 721 G	1 987 482 129

1J0 611 701	1 987 476 648
1J1 614 019	0 204 123 339
110 595 032	0 986 475 811
114 595 012	0 986 480 630
115 595 015	0 986 480 683

115 595 030	0 986 475 812
115 595 610	1 987 476 555
115 595 612	1 987 476 646
115 595 620	1 987 476 647
115 595 621	1 987 476 647



116 595 322	0 204 131 310
116 595 322	0 986 482 007
4A0 612 107 A	0 986 485 131
6N0 611 701	1 987 476 696
6N0 611 701 A	1 987 476 696

6N0 611 701 B	1 987 476 696
6N0 611 775 A	1 987 476 697
6Q7 609 721 C	1 987 482 193
6Q7 609 721 E	1 987 482 193
6U0 609 721	1 987 477 690

6U0 611 019	0 986 480 682
6U0 611 053	0 986 475 864
6U0 611 053 A	0 986 475 865
6U0 611 053 B	0 986 475 769
6U0 612 151 A	0 204 131 310

6U0 612 151 A	0 986 482 007
701 611 701 A	1 987 476 698
8D0 611 707 B	1 987 476 717
8E0 611 775 B	1 987 476 719
8E0 611 775 E	1 987 476 719

SUZUKI

00000 A00159	0 986 475 814
00000 A01221	0 986 475 814
26402AE390	F 01G 09B 1L6

37520 10B3	0 261 231 036
51008 55GE0 000	F 01G 060 0LN
51008 55GF0 000	F 01G 060 0LR
51100 T62J10	0 204 054 366
51100 T62J3	0 204 051 327

51100 T69K00	0 204 051 867
51100 T69K10	0 204 051 868
51100 T69K50	0 204 051 869
51100 T69K51	0 204 051 869
51100 T69K61	0 204 051 870

51100 T79J00 000	0 204 051 536
51100 T79J10 000	0 204 051 535
51100 T86G00	0 204 123 647
51100 T86G10	0 204 123 646
51100 50A10 000	F 01G 09C 0P1

51100 50A21 000	F 01G 09C 0P0
51100 50E50 000	F 01G 09C 1BW
51100 54C50 000	F 01G 09C 0XD
51100 54G00 000	F 01G 09C 11T
51100 54G10 000	F 01G 09C 0X2

51100 55GE0 000	F 01G 09C 12Z
51100 55GF0 000	F 01G 09C 130
51100 55G70 000	F 01G 09C 12H
51100 55G80 000	F 01G 09C 12J
51100-57K00	0 204 054 376

51100-57K20	0 204 054 382
51100 58J00 000	F 01G 062 003
51100 58J50 000	F 01G 062 005
51100-60A30	0 986 480 778
51100-60B10	0 986 480 660

51100-60B20	0 986 480 780
51100 60D1V 000	F 01G 09C 0XX
51100 60D10 000	F 01G 09C 0XW
51100 60F10 000	F 01G 09C 1C3
51100 60F20 000	F 01G 09C 1BV

51100 60F30 000	F 01G 09C 1BU
51100 60J00 000	F 01G 09C 1D0
51100 60J10 000	F 01G 09C 1D1
51100 62G10 000	F 01G 09C 1FR
51100 62G30 000	F 01G 09C 0TU

51100 62G31 000	F 01G 09C 0XC
51100 62G50 000	F 01G 09C 1BD
51100-62J10	0 204 054 366
51100-62J30	0 204 051 327
51100-62J30	0 204 054 379

51100 65G10 000	F 01G 09C 1BN
51100 65J00 000	0 204 023 107
51100 65K00 000	0 204 023 388
51100 65K50 000	0 204 023 386
51100 66310 000	F 01G 09C 0K4

51100 69D00 000	F 01G 09C 1BS
51100 69D1V 000	F 01G 09C 1BT
51100 69G11 000	F 01G 09C 1D3
51100-69K00	0 204 054 419
51100-69K10	0 204 054 420

51100-69K51	0 204 054 421
51100-69K61	0 204 054 568
51100-70A00	0 986 480 781
51100-70A40	0 986 480 782
51100 70B20 000	F 01G 09C 0R6

51100 70B40 000	F 01G 09C 1C4
51100 7001V 000	F 01G 09C 0K5
51100 73H00 000	F 01G 09C 1EB
51100 73H00 000	F 01G 062 018
51100 73H50 000	F 01G 09C 1EC

51100 73H50 000	F 01G 062 01A
51100 7361V 000	F 01G 09C 0KE
51100 74FA0 000	F 01G 09C 10E
51100 74FDV 000	F 01G 09C 1BZ
51100 74F00 000	F 01G 09C 0ZM

51100 74F10 000	F 01G 09C 1C2
51100 74G50 000	F 01G 09C 0X3
51100 75FAV 000	F 01G 09C 1BY
51100 75FBV 000	F 01G 09C 1C1
51100 75FC0 000	F 01G 09C 0V8

51100 75FOV 000	F 01G 09C 1BX
51100 75F1V 000	F 01G 09C 1C0
51100 75F30 000	F 01G 09C 11A
51100 75F51 000	F 01G 09C 115
51100 75H00 000	F 01G 09C 1ED

51100 75H00 000	F 01G 062 01C
51100 75H50 000	F 01G 062 01E
51100 76F12 000	F 01G 09C 11P
51100 76F12 000	F 01G 09C 11R
51100 76F13 000	F 01G 09C 11B

51100 76F13 000	F 01G 09C 11C
51100 76F20 000	F 01G 09C 1DJ
51100 76F71 000	F 01G 09C 1DG
51100 76G21 000	F 01G 062 00U
51100 78F01 000	F 01G 09C 1DR

51100 78F51 000	F 01G 062 00W
51100-79J00	0 204 054 374
51100-79J10	0 204 054 380
51100 79J10 000	0 204 054 380
51100 80F00 000	F 01G 09C 1BP

51100 80F1V 000	F 01G 09C 1BR
51100 80G01 000	F 01G 09C 1DW
51100 80G01 000	F 01G 062 012
51100 80G21 000	F 01G 09C 1DM
51100 80G21 000	F 01G 062 00S

51100 80G61 000	F 01G 09C 1DU
51100 80G61 000	F 01G 062 010
51100 80G71 000	F 01G 09C 1DK
51100 80G71 000	F 01G 062 00P
51100 80J00 000	0 204 023 290

51100-80660	0 986 480 786
51100-81K00-000	0 204 053 186
51100-81K10-000	0 204 053 188
51100 8101V 000	F 01G 09C 0KW
51100 8211V 000	F 01G 09C 0KS

51100-82170	0 986 480 788
51100-83E10	0 986 480 872
51100-83020	0 986 480 789
51100 84010 000	F 01G 09C 0LS
51100 8531V 000	F 01G 09C 0M8

51100 85410 000	F 01G 09C 0M7
51100 86G30 000	F 01G 09C 1DZ
51100 86G30 000	F 01G 062 016
51100 86G40 000	F 01G 09C 1DY
51100 86G40 000	F 01G 062 014

51300 T57K0 000	0 204 051 575
51300 T62J0	0 204 051 175
51300 T79J00 000	0 204 051 534
51300 T79J01	0 204 051 534
51300 T7901	0 204 051 534

51300 T86G00	0 204 125 815
51300 50A21 000	F 01G 09B 23Y
51300 54C50 000	F 01G 09B 1TT
51300 54G00 000	F 01G 09B 1WR
51300 54G10 000	F 01G 09B 1WS

51300 54G20 000	F 01G 09B 1WW
51300 55GC0 000	F 01G 061 0DM
51300 55GC0 000	F 01G 061 095
51300 55G00 000	F 01G 09B 1WU
51300 55G10 000	F 01G 09B 1WV

51300 55G20 000	F 01G 09B 1WY
51300 56B60 000	F 01G 09B 168
51300 58J00 000	F 01G 061 0CE
51300 58J00 000	F 01G 061 00X
51300 58J10 000	F 01G 061 0CF

51300 58J10 000	F 01G 061 00Y
51300 58J20 000	F 01G 061 0K6
51300 58J30 000	F 01G 061 0K7
51300 58J50 000	F 01G 061 00Z
51300 58J60 000	F 01G 061 0CH

51300 58J60 000	F 01G 061 010
51300 59C00 000	F 01G 09B 1RF
51300 60DL0 000	F 01G 09B 0X3
51300 60D11 000	F 01G 09B 22K
51300 60FA0 000	F 01G 09B 0X2

51300 60J00 000	F 01G 061 00K
51300 60J10 000	F 01G 061 00L
51300 60J20 000	F 01G 061 00M
51300 62G00 000	F 01G 09B 11J
51300-62J00	0 204 051 175

51300 65GA0 000	F 01G 09B 1T5
51300 65GA1 000	F 01G 09B 1T6
51300 65G00 000	F 01G 09B 1T3
51300 69D00 000	F 01G 09B 0X4
51300 69G10 000	F 01G 09B 1T4

51300 70B20 000	F 01G 09B 23Z
51300 70F10 000	F 01G 09B 22N
51300 73H00 000	F 01G 09B 1RP
51300 73H20 000	F 01G 061 0CK
51300 73H20 000	F 01G 061 006

51300 73H50 000	F 01G 09B 1RU
51300 73H50 000	F 01G 061 0CL
51300 73H70 000	F 01G 061 0CM
51300 73H70 000	F 01G 061 007
51300 74FA0 000	F 01G 09B 22M

51300 74F00 000	F 01G 09B 22L
51300 74G60 000	F 01G 061 003
51300 75F00 000	F 01G 09B 0XC
51300 75F10 000	F 01G 09B 0YL
51300 75F11 000	F 01G 09B 1RE

51300 75F30 000	F 01G 09B 22Y
51300 75F50 000	F 01G 09B 22W
51300 75H20 000	F 01G 061 0CP
51300 75H20 000	F 01G 061 004
51300 75H70 000	F 01G 061 005

51300 76F10 000	F 01G 09B 231
51300 76F11 000	F 01G 09B 232
51300 76F20 000	F 01G 09B 1RC
51300 76F21 000	F 01G 09B 1RH
51300 76F30 000	F 01G 09B 233

51300 76F31 000	F 01G 09B 234
51300 76F70 000	F 01G 09B 1RM
51300 76F70 000	F 01G 061 0C7
51300 76F71 000	F 01G 061 0M1
51300 76F80 000	F 01G 09B 1RN

51300 76F90 000	F 01G 061 000
51300 76F90 000	F 01G 061 0C9
51300 76F91 000	F 01G 061 0M2
51300 76GA0 000	F 01G 09B 22X
51300 76G20	F 01G 09B 1RJ

◀ SUZUKI

51300 76G20 000	F 01G 09B 1RG
51300 78F50 000	F 01G 09B 1TG
51300-79J00	0 204 051 534
51300-79J01	0 204 051 534
51300 80E00 000	F 01G 09B 22P

51300 80F00 000	F 01G 09B OXB
51300 80G00 000	F 01G 09B 1TB
51300 80G00 000	F 01G 09B 1T9
51300 80G00 000	F 01G 061 0D8
51300 80G20 000	F 01G 09B 1TA

51300 80G20 000	F 01G 09B 1TC
51300 80G20 000	F 01G 061 0D9
51300 80G50 000	F 01G 09B 1TJ
51300 80G51 000	F 01G 061 0DA
51300 80G60 000	F 01G 09B 1TD

51300 80G70 000	F 01G 09B 1TE
51300 80H00 000	F 01G 09B 1PZ
51300 80H10 000	F 01G 061 002
51300-83E00	0 204 125 742
51300 84G00 000	F 01G 09B 1RK

51300 84G00 000	F 01G 061 0CB
51300 84G01 000	F 01G 061 0M4
51300 84G10 000	F 01G 09B 1RL
51300 84G20 000	F 01G 061 0CD
51300 84G20 000	F 01G 061 001

51300 84G21 000	F 01G 061 0M5
51300 85510 000	F 01G 09B 23X
51300 86G30 000	F 01G 09B 1TF
51300 86G30 000	F 01G 061 0DD
51311 65J00 000	0 204 223 608

51540-60A30	1 987 481 065
51540-60A31	1 987 481 065
51540-60A31	1 987 481 096
51540-65D00	1 987 476 935
51540-80150	1 987 476 547

51540-80151	1 987 476 772
51540-81A00	1 987 476 933
51540-82050	1 987 481 033
51550M70F10	1 987 481 024
51550-60A30	1 987 481 071

51550-60A31	1 987 481 071
51550-65D00	1 987 476 934
51550-81A00	1 987 476 932
51550-83E00	1 987 476 429
51550-84150	1 987 476 936

51560M72F10	1 987 481 060
51560-65D00	1 987 481 178
51560-82050	1 987 481 035
51560-83031	1 987 476 937
51560-86000	1 987 481 035

51570-50A50	1 987 476 395
51570-76G00	1 987 476 908
51570-83E00	1 987 476 436
51580-60G00	1 987 476 961
51580 63BB0	1 987 476 787

51580-63B00	1 987 476 787
51590-60B00	1 987 476 159
51930 T83E10	0 204 031 174
53401 T62J0	0 204 011 407
53401-56B00	0 986 475 861

53401-60A00	0 986 475 727
53401-62J00	0 204 011 407
53401-62J00	0 986 475 951
53401-63B00	0 986 475 857
53401-65D00	0 986 475 962

53401-70B11	0 986 475 952
53401 80ECO	0 204 116 559
53401-80050	0 986 475 729
53401-81A00	0 986 475 964
53401 81011 000	F 01G 09G ODP

53401-82030	0 986 475 766
53401-83040	0 986 475 859
53401-84010	0 986 475 767
53401-86040	0 986 475 680
53401-86041	0 986 475 680

53402-56B00	0 986 475 860
53402-60A00	0 986 475 726
53402-63B00	0 986 475 856
53402-65D00	0 986 475 963
53402 67010 000	F 01G 09G 08W

53402-70B11	0 986 475 953
53402 80ECO	0 204 116 560
53402-80050	0 986 475 728
53402-81A00	0 986 475 965
53402 81011 000	F 01G 09G 08X

53402-83040	0 986 475 858
54400M70F10	1 987 482 088
54400-60B00	1 987 477 605
54400-62B00	1 987 477 606
54401M79G00	1 987 482 211

54401M79G10	1 987 482 211
54401-60G00	1 987 477 607
54401-60G10	1 987 477 608
54401-62G00	1 987 477 793
54402M79G00	1 987 482 096

54402-60G10	1 987 477 609
54402-64G00	1 987 477 610
54402-78F10	1 987 482 176
54402-78F11	1 987 482 176
54410-60A60	1 987 482 089

54410-60A63	1 987 482 089
54410-65D00	1 987 482 090
54410-65D10	1 987 482 094
54410-81A01	1 987 477 875
54410-83E20	1 987 477 995

54410-86G00	1 987 482 092
54420A 60A60	1 987 482 184
54420-56B60	1 987 477 874
54420-60A60	1 987 482 184
54420-65D00	1 987 482 091

54420-65D10	1 987 482 095
54420-81A00	1 987 477 875
54420-81A01	1 987 477 875
54420-86G00	1 987 482 093
55103 T84E0	0 204 204 712

55103-84E00	0 204 204 712
55104 T84E0	0 204 204 711
55104-84E00	0 204 204 711
55600 27E50 000	F 01G 09D 0A8
55800 27E50 000	F 01G 09E 000

55840-84E00	0 204 104 298
55850-84E00	0 204 104 299
56100 T80E0	0 265 216 599
56100-80E00	0 265 216 599
56100-80E10	0 265 216 611

56100 80F00 000	F 01G 09D 01K
56100 80JA0 000	0 265 235 388
56100 80JB0 000	0 265 235 389
56100 80JC0 000	0 265 235 390
56100 80JD0 000	0 265 235 391

56110 T79J80	0 265 231 669
56110 T79J90	0 265 231 671
56110-79J80	0 265 231 669
56110-79J90	0 265 231 671
56210-79J00-000	0 265 007 955

56310-79J00-000	0 265 007 957
56320-79J00-000	0 265 007 956

TALBOT	
A 514 880 80	0 261 231 001
ZF 044 509 38	1 987 477 515
00 007 491 55	0 204 122 041

00 129 592 00	0 204 163 006
00 132 282 00	0 204 162 013
00 135 336 00	0 204 162 018
00 135 455 00	F 026 002 506
00 135 455 00	0 204 116 506

00 135 457 00	0 986 475 230
00 135 577 00	F 026 002 087
00 135 577 00	0 204 116 087
00 135 577 00	0 986 475 209
00 138 968 00	0 204 131 103

00 138 968 91	0 204 131 103
00 164 637 00	0 204 162 020
00 169 398 00	0 204 162 022
00 174 742 00	F 026 002 087
00 174 742 00	0 204 116 087

00 174 742 00	0 986 475 209
00 174 942 00	0 204 123 022
00 175 835 00	0 204 116 515
00 176 719 00	0 204 123 469
00 176 800 00	0 986 475 230

00 255 680 00	0 204 131 032
00 432 763 00	F 026 003 243
00 543 386 00	1 987 476 222
00 559 477 14	0 204 163 105
00 750 619 58	1 987 476 474

05 215 935 00	0 204 131 022
17 473 700	0 204 123 022
17 511 000	0 204 116 090
20 666 000 00	1 987 476 474
26 522 300 00	1 987 476 474

40 331 197 20	0 204 123 227
43 216 000	0 204 162 031
43 248 600	0 204 104 034
43 255 500	0 204 104 035
4402 44	F 026 002 507

4402 44	0 986 475 230
4402 52	0 986 475 781
4402 56	F 026 002 110
4402 56	0 204 116 110
4402 62	F 026 002 506

4402 62	0 204 116 506
4402 63	F 026 002 087
4402 63	0 204 116 087
4402 65	F 026 002 204
4402 65	0 204 116 204

4402 65	0 986 475 141
4402 66	F 026 002 205
4402 66	0 204 116 205
4402 67	0 204 116 202
4402 68	F 026 002 217

4402 68	0 204 116 203
4745 A0	1 987 477 432
4745 A1	1 987 477 431
4745 A2	1 987 477 432
4745 A4	1 987 477 434

4745 A5	1 987 477 435
4745 E8	1 987 477 436
4745 F7	1 987 477 437
4745 G0	1 987 477 438
4745 G5	1 987 477 439

4745 G6	1 987 477 440
4745 H5	1 987 477 441
4745 H7	1 987 477 442
4745 K4	1 987 477 443
4745 K8	1 987 477 445

4745 K9	1 987 477 446
4745 40	1 987 477 416
4745 52	1 987 477 417
4745 54	1 987 477 419
4745 57	1 987 477 420

4745 58	1 987 477 421
4745 71	1 987 477 422
4745 89	1 987 477 427
4745 97	1 987 477 429
4745 98	1 987 477 430

4745 99	1 987 477 431
4834 71	1 987 477 449
4834 72	1 987 477 450
4834 75	1 987 477 451
4834 80	1 987 477 452

4834 81	1 987 477 453
4834 85	1 987 477 455
4861 18	0 204 131 038
5887 6A	F 026 002 087
5887 6A	0 204 116 087

5887 6A	0 986 475 209
63 227 500	0 204 123 022
79 100 181 58	1 987 476 684
79 100 226 22	1 987 476 682
79 100 226 23	1 987 476 683

79 100 289 93	0 986 475 231
91 506 320 80	0 986 475 428
91 514 880 80	0 261 231 006
91 68 623	1 987 476 468
94 044 024 98	0 986 475 231

95 494 014	1 987 476 683
96 087 509 80	0 265 003 078
96 089 629 80	0 265 003 079
96 132 698	1 987 476 651
96 140 648 80	0 265 003 099

96 145 739	1 987 477 437
96 165 516 80	0 265 006 200
96 176 679	1 987 477 434
96 180 488 80	0 265 003 128
96 181 977 80	0 265 006 201

96 181 978 80	0 265 006 200
96 190 724	1 987 477 431
96 190 725	1 987 477 432
96 224 349	1 987 477 435
96 224 350	1 987 477 432

97 501 150	0 204 163 022
97 501 690	0 204 163 010
97 902 141	0 204 123 059

TOYOTA

0400516130	F 01G 060 0LV
04479 0D010	0 204 104 320
04952 09020	0 204 104 308

04953 0D010	0 204 104 320
04956 05010	0 204 104 309
13101 09002090	F 01G 061 05X
31470 10012	0 986 486 514
31470 10040	0 986 486 569

31470 12040	0 986 486 516
31470 12041	0 986 486 516
31470 12042	0 986 486 516
31470 12043	0 986 486 516
31470 12060	0 986 486 569

31470 20151	0 986 486 518
31470 32010	0 986 486 519
31470 32020	0 986 486 519
31470 32022	0 986 486 519
44050 0D010	0 265 216 853

44050 0D011	0 265 216 905
44050 0D012	0 265 218 662
44050 0D013	0 265 218 662
44050 0F010	0 265 231 485
44050 0F020	0 265 225 285

44050 0F021	0 265 225 285
44050 0F030	0 265 234 223
44050 0H010	0 265 231 580
44050 0W010	0 265 202 426
44050 02009	0 265 225 289

44050 02030	0 265 216 851
44050 02031	0 265 216 851
44050 02050	0 265 225 118
44050 02050	0 265 225 262
44050 02051	0 265 225 262

44050 02090	0 265 225 293
44050 02091	0 265 225 293
44050 02100	0 265 225 287
44050 02100	0 265 225 289
44050 02101	0 265 225 289

44050 02110	0 265 225 287
44050 02110	0 265 225 291
44050 02111	0 265 225 287
44050 02120	0 265 225 291
44050 02120	0 265 225 293

44050 02121	0 265 225 291
44050 05010	0 265 216 486
44050 05020	0 265 216 826
44050 05050	0 265 231 328
44050 05051	0 265 231 328

44050 05052	0 265 231 465
44050 05060	0 265 225 229
44050 05060	0 265 225 283
44050 05061	0 265 225 229
44050 05061	0 265 225 283

44050 05062	0 265 225 283
44050 05063	0 265 225 320
44050 05063	0 265 225 326
44050 05070	0 265 231 467
44050 05080	0 265 225 326

44050 05081	0 265 225 326
44050 05110	0 265 225 388
44050 05111	0 265 225 388
44050 05120	0 265 225 390
44050 05121	0 265 225 390

44510 0H010	0 265 231 580
44510 05010	0 265 214 001
44510 05011	0 265 214 001
44510 07010	0 265 208 054
44540 0W010	0 265 202 426

44540 02011	0 265 225 262
44540 02020	0 265 225 293
44540 02030	0 265 225 289
44540 02040	0 265 225 287
44540 02050	0 265 225 291

44610 0D070	0 204 125 818
446100W010	F 01G 09B 17J
44610-0W020	0 204 032 377
44610 05090	0 204 125 809
44610 05100	0 204 125 810

44610 09010	0 204 125 754
44610 09020	0 204 125 753
44610 09090	0 204 125 818
44610 09200	0 204 125 831
44610 09210	0 204 125 830

44610 09390	0 204 125 879
44610 09400	0 204 125 882
44610 09410	0 204 125 880
44610 09420	0 204 125 878
44610 09430	0 204 125 881

44610 09440	0 204 125 875
44610 09450	0 204 125 877
44610 09460	0 204 125 876
44610 09500	0 204 125 915
44610 09510	0 204 125 914

44610 09520	0 204 125 913
44610 09530	0 204 125 912
446101A050	F 01G 09B 0TY
446101A070	F 01G 09B 0TZ
446101A420	F 01G 09B 0UO

446101A500	F 01G 09B 0ZH
446101A740	F 01G 09B 0ZK
446101A840	F 01G 09B 0ZF
446101A870	F 01G 09B 0ZG
446101E150	F 01G 09B 0ZL

446101E200	F 01G 09B 0ZM
446101E230	F 01G 09B 0ZN
446101E250	F 01G 09B 0ZP
4461010100	F 01G 09B 0N4
4461010130	F 01G 09B 0MX

4461010150	F 01G 09B 0X0
4461010160	F 01G 09B 0X6
4461010260	F 01G 09B 0WZ
4461010310	F 01G 09B 0X7
4461010320	F 01G 09B 0XR

4461010440	F 01G 09B 0X8
4461012470	F 01G 09B 0MW
4461012670	F 01G 09B 0NN
4461012680	F 01G 09B 0SW
4461012690	F 01G 09B 0NP

4461013020	F 01G 09B 0N3
4461013050	F 01G 09B 0ZJ
4461013080	F 01G 09B 1SC
4461013090	F 01G 09B 1SD
4461013110	F 01G 09B 1SE

4461013120	F 01G 09B 1SF
4461014510	F 01G 09B 0KX
4461014790	F 01G 09B 0VC
4461016110	F 01G 09B 0NM
4461016170	F 01G 09B 0N2

4461016310	F 01G 09B 0XS
4461016500	F 01G 09B 0XT
4461016580	F 01G 09B 0XW
4461016660	F 01G 09B 0XX
4461017180	F 01G 09B 0ZD

4461017300	F 01G 09B 0ZE
4461017320	F 01G 09H 9NH
4461017340	F 01G 09B 1R1
4461017340	F 01G 09B 1R2
4461017341	F 01G 061 05L

44610 19015	0 204 125 886
44610 19025	0 204 125 885
44610 19035	0 204 125 883
44610 19045	0 204 125 884
446102A020	F 01G 09B 0RU

446102A060	F 01G 09B 1G5
446102A070	F 01G 09B 1G6
446102A090	F 01G 09B 1AA
446102A140	F 01G 09B 1G4
446102A150	F 01G 09B 1G3

446102A200	F 01G 09B 1G7
446102A210	F 01G 09B 1G8
446102A230	F 01G 09B 1G9
446102B360	F 01G 09B 0RC
446102B380	F 01G 09B 0NS

446102B440	F 01G 09B 0Z9
446102B480	F 01G 09B 12F
446102D070	F 01G 09B 0RD
446102D140	F 01G 09B 0TW
446102D500	F 01G 09B 0ZA

446102D630	F 01G 09B 0ZB
446102D660	F 01G 09B 1A7
446102D681	F 01G 09B 0ZC
446102D720	F 01G 09B 1A8
446102D790	F 01G 09B 0ZV

446102D810	F 01G 09B 0TV
446102D830	F 01G 09B 0ZW
446102G050	F 01G 09B 1RW
446102G050	F 01G 061 0FS
446102G050	F 01G 061 04L

446102G060	F 01G 061 09G
446102G070	F 01G 09B 1RX
446102G070	F 01G 061 0FT
446102G070	F 01G 061 04M
446102G080	F 01G 09B 1RY

446102G080	F 01G 09B 1S3
446102G080	F 01G 061 0FV
446102G080	F 01G 061 04P
446102G090	F 01G 09B 1RZ
446102G090	F 01G 09B 1S2

◀ TOYOTA

446102G090	F 01G 061 0FU
446102G090	F 01G 061 04N
446102G120	F 01G 09B 156
446102G120	F 01G 061 0FW
446102G120	F 01G 061 04R
446102G130	F 01G 09B 155
446102G130	F 01G 061 0FX
446102J020	F 01G 09B 1GW
446102J050	F 01G 09B 1UW
446102J060	F 01G 09B 1UX
446102J070	F 01G 09B 1UY
446102J080	F 01G 09B 1UZ
446102J090	F 01G 09B 1V0
446102J090	F 01G 09B 24M
446102J130	F 01G 09B 1V2
446102J140	F 01G 09B 1X1
446102J150	F 01G 09B 1V3
446102J160	F 01G 09B 1X2
446102J170	F 01G 09B 1X3
446102J180	F 01G 09B 1V4
446102J190	F 01G 09B 1V5
446102J200	F 01G 09B 1X4
446102J210	F 01G 09B 1V6
446102J220	F 01G 09B 1X5
446102J230	F 01G 09B 1V7
446102J240	F 01G 09B 1X6
4461020770	F 01G 09B 0RB
4461021070	F 01G 09B 0ZT
4461021100	F 01G 09B 0ZU
4461022530	F 01G 09B 0RL
4461022550	F 01G 09B 0RM
4461022580	F 01G 09B 0RN
4461022590	F 01G 09B 0PN
4461022600	F 01G 09B 0RP
4461022620	F 01G 09B 0TC
4461022640	F 01G 09B 0PP
4461022690	F 01G 09B 0TD
4461022720	F 01G 09B 0RS
4461022740	F 01G 09B 0RR
4461022790	F 01G 09B 0RT
4461022800	F 01G 09B 0RV
4461024060	F 01G 09B 0UN
4461024070	F 01G 09B 0WV
4461024080	F 01G 09B 0WW
4461024090	F 01G 09B 1PP
4461024100	F 01G 09B 1PR
4461024101	F 01G 09B 1PT
4461024110	F 01G 09B 1PN
4461024120	F 01G 09B 1PS
4461025150	F 01G 09B 0LA
4461025160	F 01G 09B 0LB
4461025240	F 01G 09B 11T
4461025260	F 01G 09B 11R
4461025270	F 01G 09B 11U
4461025280	F 01G 09B 11V

4461025290	F 01G 09B 11W
4461026210	F 01G 09B 0RA
4461026330	F 01G 09B 0L6
4461026370	F 01G 09B 14Z
4461026471	F 01G 09B 1FL
4461026471	F 01G 09B 1FM
4461026560	F 01G 09B 0T5
4461026561	F 01G 09B 1VP
4461026561	F 01G 09B 1VR
4461026580	F 01G 09B 0T4
4461026620	F 01G 09B 1FN
4461026660	F 01G 061 031
4461026661	F 01G 061 0NJ
4461026670	F 01G 061 02H
4461026671	F 01G 061 0NR
4461026680	F 01G 061 032
4461026681	F 01G 061 0NK
4461026690	F 01G 061 02J
4461026691	F 01G 061 0NS
4461026700	F 01G 061 033
4461026701	F 01G 061 0NG
4461026710	F 01G 061 02K
4461026711	F 01G 061 0NN
4461026721	F 01G 061 0NH
4461026731	F 01G 061 0NP
4461026751	F 01G 061 0NT
4461027250	F 01G 09B 0RW
4461028A00	F 01G 09B 1V8
4461028300	F 01G 09B 0UG
4461028400	F 01G 09B 0UH
4461028430	F 01G 09B 0TB
4461028750	F 01G 09B 0V7
4461028770	F 01G 09B 0U1
4461028800	F 01G 09B 0V8
4461028850	F 01G 09B 0VA
4461028880	F 01G 09B 0R9
446103A020	F 01G 09B 192
446103A050	F 01G 09B 17K
446103A060	F 01G 09B 1GA
446103A070	F 01G 09B 1GC
446103A071	F 01G 061 0G9
446103A140	F 01G 09B 1GD
446103A180	F 01G 09B 1GE
446103A190	F 01G 09B 1P7
446103A200	F 01G 09B 1P8
446103A210	F 01G 09B 1P9
446103A220	F 01G 09B 1PA
446103A230	F 01G 09B 1PG
446103A240	F 01G 09B 1PC
446103A240	F 01G 09B 1PH
446103A250	F 01G 09B 1PD
446103A250	F 01G 09B 1PJ
446103A260	F 01G 09B 1PK
446103A270	F 01G 09B 1PF
446103A270	F 01G 09B 1PL

446103D140	F 01G 09B 0RK
446103D160	F 01G 09B 0TF
446103D170	F 01G 09B 0UR
446103D190	F 01G 09B 0NX
446103D200	F 01G 09B 0NY
446103D210	F 01G 09B 0P0
446103D230	F 01G 09B 0NZ
446103D330	F 01G 09B 0US
446103D450	F 01G 09B 14Y
446103D460	F 01G 09B 17G
446103D610	F 01G 09B 1FH
446103D620	F 01G 09B 1PU
446103D700	F 01G 09B 1FK
4461030A20	F 01G 061 0A6
4461030A30	F 01G 061 0A7
4461030A40	F 01G 061 0A8
4461030A90	F 01G 061 0A9
4461030440	F 01G 09B 0L7
4461030520	F 01G 09B 0RE
4461030570	F 01G 09B 0UK
4461030590	F 01G 09B 0RF
4461030600	F 01G 09B 0UL
4461030601	F 01G 09B 0V5
4461030620	F 01G 09B 0NT
4461030730	F 01G 09B 0UM
4461030740	F 01G 09B 0V6
4461030780	F 01G 09B 190
4461030790	F 01G 09B 191
4461030800	F 01G 09B 0WX
4461030810	F 01G 09B 23M
4461030820	F 01G 09B 17L
4461030840	F 01G 09B 0RG
4461032430	F 01G 09B 12H
4461032550	F 01G 09B 1A9
4461032560	F 01G 09B 0SZ
4461033040	F 01G 09B 12K
4461033060	F 01G 09B 12G
4461033120	F 01G 09B 0VK
4461033240	F 01G 09B 0VE
4461033270	F 01G 09B 0VD
4461033360	F 01G 09B 0VG
4461033370	F 01G 09B 0VH
4461033380	F 01G 09B 0VJ
4461033470	F 01G 09B 1FW
4461033480	F 01G 09B 1FX
4461033500	F 01G 09B 24F
4461033521	F 01G 09B 1FY
4461033670	0 204 023 137
4461033680	0 204 023 138
4461033740	0 204 023 139
4461033750	0 204 023 140
44610-33780	0 204 053 256
44610-33800	0 204 053 359
44610-33810	0 204 053 360
44610-33820	0 204 053 361

44610-33830	0 204 053 362
4461034010	F 01G 09B 193
4461034020	F 01G 09B 194
4461034030	F 01G 09B 1FJ
4461035620	F 01G 09B 0NV
4461035730	F 01G 09B 0NW
4461035740	F 01G 09B 0NU
4461035810	F 01G 09B 0RH
4461035870	F 01G 09B 0RJ
4461036321	F 01G 09B 0LE
4461036331	F 01G 09B 0LC
4461036332	F 01G 09B 0LF
4461036371	F 01G 09B 0LN
4461036381	F 01G 09B 0LD
4461036390	F 01G 09B 0LP
4461036400	F 01G 09B 0LH
4461036410	F 01G 09B 0LJ
4461036420	F 01G 09B 0LK
4461036430	F 01G 09B 0LL
4461036450	F 01G 09B 11Y
4461036460	F 01G 09B 0LM
4461036480	F 01G 09B 23H
4461036490	F 01G 09B 11Z
4461036520	F 01G 09B 12P
4461036530	F 01G 09B 12R
4461036540	F 01G 09B 23J
4461036550	F 01G 09B 12S
4461036560	F 01G 09B 12T
4461036600	F 01G 09B 125
4461036610	F 01G 09B 12Y
4461036620	F 01G 09B 1N5
4461036630	F 01G 09B 1N6
4461037020	F 01G 09B 0LR
4461037050	F 01G 09B 120
4461037060	F 01G 09B 12U
4461037120	F 01G 09B 12W
4461037140	F 01G 09B 124
4461037151	F 01G 09B 1NC
4461037151	F 01G 09B 1NE
4461037161	F 01G 09B 1NF
4461037180	F 01G 09B 11S
4461037190	F 01G 09B 126
4461037210	F 01G 09B 292
4461037240	F 01G 09B 127
4461037250	F 01G 09B 1NJ
4461040090	F 01G 09B 18X
4461040091	F 01G 09B 18Y
4461040100	F 01G 09B 1GF
4461040101	F 01G 09B 1GJ
4461040111	F 01G 09B 1GK
4461040111	F 01G 09B 1GN
4461040120	F 01G 09B 1GG
4461040121	F 01G 09B 1GL
4461040121	F 01G 09B 1GP
4461040130	F 01G 09B 1GH



4461040131	F 01G 09B 1GM	4461052251	F 01G 061 05H	46410 20380	1 987 477 986	47025 09040	0 204 123 786
4461040131	F 01G 09B 1GR	4461052330	F 01G 09B 1SU	46410 28100	1 987 482 161	47200 02B10	0 204 123 782
4461040140	F 01G 09B 1GS	4461052331	F 01G 061 02A	46410 42010	1 987 477 996	47200 09020	0 204 123 666
4461040150	F 01G 061 0FR	4461052340	F 01G 09B 1SV	46410 42040	1 987 477 794	47200 37312	F 01G 09B 1NP
4461040150	F 01G 061 09A	4461052341	F 01G 061 05J	46410 44050	1 987 482 157	47200 37322	F 01G 09B 1NL
4461040160	F 01G 061 0GZ	4461052370	0 204 023 834	46420 0D010	1 987 482 156	47200 37391	F 01G 09B 1NK
4461042020	F 01G 09B 0T6	4461052380	0 204 023 835	46420 0D050	1 987 477 090	4720052312	F 01G 060 0DB
4461042130	F 01G 09B 1V9	4461052390	0 204 023 836	46420 0D060	1 987 477 070	47201 0F010	0 204 123 654
4461042140	F 01G 09B 1VA	4461052400	0 204 023 837	46420 0H010	1 987 477 951	47201 0F011	0 204 123 706
4461042170	F 01G 09B 1VB	4461052410	0 204 023 838	46420 02040	1 987 477 409	47201 0F012	0 204 123 706
4461042240	F 01G 061 09K	4461052420	0 204 023 210	46420 05020	1 987 477 540	47201 0F020	0 204 123 656
4461043020	F 01G 09B 0SX	4461052420	0 204 023 839	46420 12310	1 987 477 319	47201 0F021	0 204 123 656
4461043022	F 01G 09B 0SY	4461052480	0 204 023 183	46420 12340	1 987 477 314	47201 0F030	0 204 123 655
4461043041	F 01G 09B 1AE	4461052480	0 204 023 842	46420 12400	1 987 477 409	47201 0F030	0 204 123 707
4461043061	F 01G 09B 1AF	4461052500	0 204 023 184	46420 18030	1 987 477 997	47201 0F031	0 204 123 707
4461043070	F 01G 09B 1AG	4461052500	0 204 023 843	46420 20351	1 987 477 410	47201 0F032	0 204 123 707
4461043080	F 01G 09B 1AJ	4461052550	0 204 023 362	46420 20440	1 987 477 795	47201 0F040	0 204 123 657
44610-43080-C	F 01G 09B 1AJ	4461052550	0 204 023 841	46420 20480	1 987 477 541	47201 0F041	0 204 123 657
4461044020	F 01G 09B 1AB	4461052560	0 204 023 840	46420 20520	1 987 482 159	472010W010	F 01G 09C 1A6
4461044110	F 01G 09B 1CP	4461052590	0 204 023 813	46420 29035	1 987 477 411	472010W010	F 01G 09C 1A7
4461044110	F 01G 09B 1CT	4461052610	0 204 023 815	46420 29045	1 987 477 414	47201 05080	0 986 480 871
4461044120	F 01G 09B 1AC	4461053030	F 01G 09B 1AK	46420 33041	1 987 482 160	47201 05090	0 204 123 629
4461044130	F 01G 09B 1CR	4461053040	F 01G 09B 1AL	46420 39045	1 987 477 796	47201 05091	0 204 123 704
4461044200	F 01G 09B 1CS	4461053080	F 01G 09B 1AM	46420 42010	1 987 477 542	47201 05092	0 204 123 704
4461044200	F 01G 09B 1CU	4461053120	F 01G 09B 1AU	46420 44010	1 987 482 061	47201 05100	0 204 123 631
4461048010	F 01G 09B 1GT	4461053130	F 01G 09B 1AV	46420 52010	1 987 477 543	47201 05101	0 204 123 631
4461048020	F 01G 09B 1GU	4461053140	F 01G 09B 1AW	46420 52050	1 987 477 549	47201 05110	0 204 123 630
4461048090	F 01G 09B 1VF	4461053190	F 01G 09B 1AS	46420 52070	1 987 482 220	47201 05111	0 204 123 705
4461048100	F 01G 09B 1VG	4461053190	F 01G 09B 1AX	46420 52080	1 987 477 919	47201 05112	0 204 123 705
4461048110	F 01G 09B 1VH	4461053210	F 01G 09B 1AT	46430 0D010	1 987 482 155	47201 05120	0 204 123 632
4461048120	F 01G 09B 1VJ	4461053210	F 01G 09B 1AY	46430 0D050	1 987 482 221	47201 05121	0 204 123 632
4461048141	F 01G 09B 1VK	4461053260	F 01G 061 0FN	46430 0D060	1 987 482 222	47201 09010	0 204 123 560
4461048142	F 01G 09B 1VM	4461053290	F 01G 061 0FP	46430 0H010	1 987 477 952	47201 09030	0 204 123 549
4461048142	F 01G 09B 1VN	4461053310	F 01G 061 0GP	46430 02040	1 987 477 413	47201 09290	0 204 123 752
4461048151	F 01G 09B 1VL	4461053330	F 01G 061 0NU	46430 05020	1 987 477 545	47201 09290	0 204 123 801
4461050150	F 01G 09B 0VL	4461053340	F 01G 061 0NV	46430 12210	1 987 477 319	47201 09300	0 204 123 751
4461050151	F 01G 09B 1FZ	446106A040	F 01G 09B 1FS	46430 12240	1 987 477 315	47201 09300	0 204 123 800
4461050160	F 01G 09B 0VM	446106A040	F 01G 09B 1FV	46430 12300	1 987 477 413	47201 09310	0 204 123 750
4461050161	F 01G 09B 1G0	4461060441	F 01G 09B 23F	46430 18030	1 987 477 998	47201 09310	0 204 123 799
4461050201	F 01G 09B 1G1	4461060530	F 01G 09B 0TE	46430 20361	1 987 477 414	47201 09320	0 204 123 749
4461050270	F 01G 09B 1G2	4461060660	F 01G 09B 0TX	46430 20600	1 987 477 546	47201 09320	0 204 123 798
4461052030	F 01G 09B 1R0	4461060792	F 01G 09B 1FP	46430 20640	1 987 482 158	47201 09340	0 204 123 560
4461052040	F 01G 09B 1SG	4461060792	F 01G 09B 1FT	46430 28200	1 987 482 162	47201 09340	0 204 123 751
4461052040	F 01G 09B 1SN	4461061020	F 01G 061 0K9	46430 29045	1 987 477 415	47201 09350	0 204 123 561
4461052041	F 01G 061 026	4461065020	F 01G 09B 0VN	46430 33041	1 987 477 797	47201 09350	0 204 123 750
4461052050	F 01G 09B 1SH	4461065030	F 01G 09B 12X	46430 39045	1 987 477 798	47201 09360	0 204 123 549
4461052050	F 01G 09B 1SP	4473012110	0 204 255 397	46430 42010	1 987 477 547	47201 09360	0 204 123 749
4461052081	F 01G 061 0A0	46410 0F010	1 987 477 240	46430 44010	1 987 482 060	47201 09370	0 204 123 781
4461052090	F 01G 09B 1SJ	46410 05020	1 987 477 539	46430 52010	1 987 477 548	47201 09380	0 204 123 782
4461052090	F 01G 09B 1SR	46410 05040	1 987 477 985	46430 52050	1 987 477 544	47201 09390	0 204 123 780
4461052091	F 01G 061 028	46410 12210	1 987 477 983	46430 52070	1 987 482 219	47201 09400	0 204 123 779
4461052099	F 01G 09B 1SM	46410 12250	1 987 477 984	46430 52080	1 987 477 918	47201 09410	0 204 123 778
4461052150	F 01G 09B 1SS	46410 12270	1 987 477 985	47025 09010	0 204 123 667	47201 09500	0 204 123 800
4461052151	F 01G 061 029	46410 20230	1 987 477 983	47025 09020	0 204 123 666	47201 09510	0 204 123 801
4461052250	F 01G 09B 1ST	46410 20300	1 987 477 984	47025 09030	0 204 123 787	47201 09520	0 204 123 798

◀ TOYOTA

47201 09530	0 204 123 799	4720720160	F 01G 09C 1CC	47550 30130	0 986 475 727	89541 0W010	0 265 109 409
47201 09590	0 204 123 194	4720720161	F 01G 062 022	47550 32010	0 986 475 651	89541 08020	0 265 109 476
47201 1A120	0 986 480 990	4720726020	F 01G 062 01P	47550 35170	0 986 475 894	89542 0D010	0 265 006 675
47201 1A150	0 986 480 990	4720726030	F 01G 062 05A	47550 39115	0 986 475 876	89542 0H010	0 265 007 687
472011A300	F 01G 09C 1D7	4720728010	F 01G 09C 1C9	47550 39285	0 986 475 651	89542 02040	0 265 006 677
472011A380	F 01G 09C 1D8	4720728020	F 01G 09C 1CA	47550 42010	0 986 475 918	89542 02140	0 265 008 182
47201 12430	0 986 480 796	4720736010	F 01G 09C 1CR	47550 42020	0 986 475 931	89542 05010	0 265 001 381
47201 12570	0 986 480 798	47207 36021	F 01G 09C 1CM	47550 52010	0 986 475 903	89542 05010	0 265 001 416
47201 12800	0 986 480 665	47207 37020	F 01G 09C 1CS	47550 52011	0 986 475 882	89542 05020	0 265 001 416
47201 12830	0 986 480 665	4720737030	F 01G 09C 1CZ	47550 60120	0 986 475 877	89542 05030	0 265 006 666
4720116160	F 01G 09C 1AD	47207 37040	F 01G 09C 1CP	47550 69105	0 986 475 877	89542 05040	0 265 006 666
47201 16180	0 986 480 655	4720737060	F 01G 062 030	47550 9095	0 986 475 602	89542 340NM	0 265 006 677
4720116200	F 01G 09C 1AF	4720737070	F 01G 062 03F	47570 05020	0 986 475 862	89542 990DL	0 265 001 381
4720116270	F 01G 09C 1AE	4720748010	F 01G 09C 1CH	47570 05030	0 986 475 883	89542 990DL	0 265 001 416
47201 19015	0 204 123 756	4720748020	F 01G 09C 1CJ	47570 05040	0 986 475 883	89543 0D010	0 265 006 674
47201 19025	0 204 123 755	4720752010	F 01G 09C 1E0	47570 10050	0 986 475 913	89543 0D011	0 265 006 674
47201 19035	0 204 123 753	4720752012	F 01G 062 00G	47570 16010	0 986 475 730	89543 02040	0 265 006 676
47201 19045	0 204 123 754	4720752020	F 01G 09C 1E1	47570 16040	0 986 475 895	89543 02060	0 265 007 806
47201 19055	0 204 123 804	4720752022	F 01G 062 00H	47570 19035	0 986 475 730	89543 02061	0 265 007 806
47201 19065	0 204 123 805	4720752032	F 01G 062 00J	47570 20030	0 986 475 730	89543 02140	0 265 008 183
47201 19075	0 204 123 802	4720752041	F 01G 062 025	47570 20040	0 986 475 652	89543 05010	0 265 001 382
47201 19085	0 204 123 803	4722026281	F 01G 262 075	47570 20051	0 986 475 652	89543 05010	0 265 001 417
47201 20360	0 986 480 802	4722026291	F 01G 262 076	47570 20060	0 986 475 734	89543 05020	0 265 001 417
4720120420	F 01G 09C 1AC	47550 0D010	0 204 011 217	47570 20101	0 986 475 897	89543 05030	0 265 006 665
47201 20550	0 986 480 696	47550 05020	0 986 475 863	47570 32010	0 986 475 652	89543 05040	0 265 006 665
47201 20610	0 986 480 805	47550 05030	0 986 475 884	47570 39115	0 986 475 652	89543 340NM	0 265 006 676
4720120780	F 01G 09C 1AG	47550 05040	0 986 475 884	47570 52010	0 986 475 902	89544 0H010	0 265 007 688
47201 20871	0 986 480 949	47550 09030	0 204 116 607	47570 52011	0 986 475 881	89544 02040	0 265 007 802
47201 20872	0 986 480 949	47550 09040	0 204 116 607	47730 0H010	0 204 004 331	89545 05010	0 265 001 418
4720128620	F 01G 09C 12C	47550 09100	0 986 475 936	47730 09020	0 204 102 986	89545 05020	0 265 001 418
4720128630	F 01G 09C 12D	47550 10080	0 986 475 912	47750 0H010	0 204 004 330	89545 05030	0 265 006 668
47201 32170	0 986 480 807	47550 12060	0 986 475 574	47750 09020	0 204 102 985	89545 05040	0 265 006 668
47201 33050	0 986 480 810	47550 16030	0 986 475 731	47900 6F605	0 265 001 417	89546 05010	0 265 001 419
47201 33060	0 986 480 811	47550 16060	0 986 475 896	49520 90200	0 204 104 308	89546 05020	0 265 001 419
4720133481	0 204 053 254	47550 19095	0 986 475 602	49560 50100	0 204 104 309	89546 05030	0 265 006 667
47201 42020	0 986 480 953	47550 19115	0 986 475 603	67000 01062	0 265 005 432	89546 05040	0 265 006 667
4720152250	0 204 023 203	47550 19116	0 986 475 603	864 02221	F 01G 09B 1FR	89615 05010	0 261 231 045
4720152260	0 204 023 205	47550 19117	0 986 475 603	89183 02010	0 265 005 260	89615 05010	0 261 231 103
4720152280	0 204 023 206	47550 19135	0 986 475 574	89183 02020	0 265 005 297	89637 07010	0 265 005 303
4720152310	0 204 023 075	47550 19155	0 986 475 731	89183 05010	0 265 005 273	90080 94A60	1 987 476 763
4720152310	0 204 023 204	47550 19165	0 986 475 844	89183 05010	0 265 005 297	90080 94A61	1 987 476 764
47207YW603	F 01G 09C 1DE	47550 20120	0 986 475 731	89183 05020	0 265 005 273	90080 94A65	1 987 476 162
47207YW60499	F 01G 062 040	47550 20130	0 986 475 651	89183 05020	0 265 005 297	90080 94A66	1 987 476 163
4720712040	F 01G 09C 1D9	47550 20141	0 986 475 651	89183 06010	0 265 005 633	90080 94060	1 987 476 761
4720712050	F 01G 09C 1DA	47550 20150	0 986 475 735	89183 06010	0 265 005 650	90080 94061	1 987 476 762
4720717010	F 01G 09C 1DB	47550 20211	0 986 475 898	89183 07010	0 265 005 226	90080 94065	1 987 476 160
4720717011	F 01G 062 028	47550 26090	0 986 475 876	89183 07020	0 265 005 274	90080 94066	1 987 476 161
4720717020	F 01G 09C 1DC	47550 26100	0 986 475 845	89183 08010	0 265 005 273	90080 94133	1 987 476 207
4720717021	F 01G 062 029	47550 29035	0 986 475 574	89183 08010	0 265 005 297	90080 94178	1 987 476 212
4720720130	F 01G 09C 1C7	47550 29115	0 986 475 574	8918312030	0 265 005 633	90080 94199	1 987 476 229
4720720131	F 01G 062 01X	47550 29175	0 986 475 845	89245 02010	0 265 005 432	90080 94200	1 987 476 246
4720720140	F 01G 09C 1C8	47550 29265	0 986 475 876	89245 02020	0 265 005 487	90080 94203	1 987 476 834
4720720141	F 01G 062 01Y	47550 29275	0 986 475 845	89245 05010	0 265 005 426	90080 94204	1 987 476 833
4720720150	F 01G 09C 1CB	47550 30100	0 986 475 657	89540 05010	0 265 108 009	90080 94205	1 987 481 062
4720720151	F 01G 062 021	47550 30120	0 986 475 877	89540 05020	0 265 108 007	90947 W2001	1 987 481 177

90947 W2002	1 987 476 780
90947 W2003	1 987 476 355
90947 W2004	1 987 476 457
90947 02A07	1 987 481 128
90947 02A08	1 987 481 127

90947 02A09	1 987 481 128
90947 02A10	1 987 481 127
90947 02A45	1 987 476 833
90947 02A46	1 987 476 834
90947 02B14	1 987 481 154

90947 02C04	1 987 481 037
90947 02C05	1 987 481 036
90947 02C30	1 987 476 165
90947 02C31	1 987 476 837
90947 02C32	1 987 476 838

90947 02C47	1 987 476 250
90947 02C48	1 987 476 257
90947 02C50	1 987 476 270
90947 02C53	1 987 481 181
90947 02C54	1 987 476 106

909470 2C55	1 987 476 108
90947 02C75	1 987 476 452
90947 02C76	1 987 476 358
909470 2D02	1 987 476 127
909470 2D03	1 987 476 113

90947 02D76	1 987 476 837
90947 02D77	1 987 476 838
90947 02E84	1 987 481 177
90947 02F25	1 987 481 128
90947 02F26	1 987 481 127

90947 02155	1 987 476 431
90947 02339	1 987 476 431
90947 02344	1 987 476 495
90947 02393	1 987 476 431
90947 02429	1 987 476 496

90947 02446	1 987 476 497
90947 02447	1 987 476 943
90947 02454	1 987 476 498
90947 02455	1 987 476 498
90947 02461	1 987 476 720

90947 02465	1 987 476 721
90947 02472	1 987 476 552
90947 02496	1 987 476 496
90947 02497	1 987 476 552
90947 02498	1 987 476 496

90947 02511	1 987 476 722
90947 02512	1 987 476 723
90947 02532	1 987 476 551
90947 02533	1 987 476 552
90947 02540	1 987 476 496

90947 02548	1 987 476 552
90947 02550	1 987 476 498
90947 02555	1 987 476 551
90947 02565	1 987 476 724
90947 02603	1 987 476 725

90947 02614	1 987 481 130
90947 02615	1 987 481 131
90947 02633	1 987 476 745
90947 02634	1 987 476 726
90947 02637	1 987 476 725

90947 02659	1 987 476 255
90947 02660	1 987 476 727
90947 02668	1 987 481 104
90947 02669	1 987 481 105
90947 02694	1 987 476 164

90947 02734	1 987 476 963
90947 02736	1 987 476 962
90947 02742	1 987 476 781
90947 02743	1 987 476 782
90947 02750	1 987 481 104

90947 02751	1 987 481 105
90947 02757	1 987 481 042
90947 02758	1 987 481 040
90947 02762	1 987 481 106
90947 0278	1 987 476 205

90947 02781	1 987 476 757
90947 02782	1 987 476 758
90947 02798	1 987 476 255
90947 02799	1 987 476 727
90947 02809	1 987 476 259

90947 02813	1 987 476 744
90947 02814	1 987 476 745
90947 02848	1 987 481 106
90947 02852	1 987 476 053
90947 02862	1 987 481 129

90947 02874	1 987 481 132
90947 02887	1 987 476 781
90947 02888	1 987 476 782
90947 02910	1 987 476 255
90947 02911	1 987 476 255

90947 02912	1 987 476 727
90947 02913	1 987 476 727
90947 02921	1 987 481 016
90947 02940	1 987 476 497
90947 02980	1 987 476 127

90947 02981	1 987 476 113
9485 2993	1 987 477 409
9485 7010	1 987 477 413
9485 7024	1 987 477 409
9485 7025	1 987 477 413

96940 30265	1 987 476 495
96940 31282	1 987 476 495
96940 31283	1 987 476 495
96940 32605	1 987 476 495
96940 32805	1 987 476 495

96940 34305	1 987 476 938
96940 34405	1 987 476 940
96940 39855	1 987 476 939
96950 02465	1 987 476 499
96950 31323	1 987 476 431

96950 32405	1 987 476 731
96950 32406	1 987 476 731
96950 33205	1 987 476 431
96950 33455	1 987 476 497
96950 33505	1 987 476 721

96960 32454	1 987 481 198
-------------	----------------------

VAUXHALL

13116133	1 987 481 161
13116134	1 987 481 162
24407363	0 986 475 029

24468130	1 987 477 869
3487357	0 986 472 464
3487379	0 986 472 002
3487992	0 986 472 003
562363	1 987 481 147

90000425	1 987 477 026
90007425	0 986 475 029
90009375	0 986 471 903
90009376	0 986 471 904
90009591	0 986 475 031

90077695	1 987 476 011
90077917	1 987 476 013
90079277	1 987 476 014
90079377	1 987 476 017
90079571	1 987 476 692

90079577	1 987 476 014
90090964	1 987 476 440
90095420	1 987 477 031
90112981	1 987 477 049
90121718	1 987 476 020

90125512	1 987 477 132
90125513	1 987 477 131
90166223	0 986 471 889
90166224	0 986 471 890
90167263	0 986 472 461

90168898	1 987 476 405
90184271	1 987 477 138
90187521	0 986 471 891
90187522	0 986 471 892
90193357	1 987 477 138

90193363	1 987 477 031
90199759	1 987 476 020
90209242	0 986 475 029
90217297	1 987 476 693
90222437	1 987 477 250

90223404	1 987 477 134
90235424	0 986 475 031
90235999	1 987 476 030
90297533	0 986 471 948
90297534	0 986 471 947

90297765	0 986 471 905
90297766	0 986 471 906
90297775	0 986 471 913
90297776	0 986 471 914
90348302	0 986 471 943

90348303	0 986 471 944
90374841	1 987 477 250
90374902	1 987 477 130
90421729	0 986 471 901
90421730	0 986 471 902

90421739	0 986 471 899
90421740	0 986 471 900
90421744	0 986 471 895
90421745	0 986 471 896
90421896	0 986 471 896

90445758	1 987 476 030
90473314	1 987 476 690
90473452	1 987 476 691
90487042	0 986 471 905
90487043	0 986 471 906

90487045	0 986 471 913
90487046	0 986 471 914
90495787	1 987 476 644
90498300	0 986 475 143
90538629	1 987 477 258

90581456	0 986 475 869
91149880	1 987 481 147
9117594	0 986 480 846
9193220	0 986 480 846
93182621	1 987 481 186

97134830	1 987 476 911
97134831	1 987 476 549

VW (VOLKSWAGEN)

BAA 611 775 A	1 987 476 289
J47 550 260 90	0 986 475 876
V037 953 91	0 986 475 438

000 396 302 3	0 204 131 045
000 396 302 3	0 204 131 716
000 396 423 5	0 204 131 141
000 396 722 5	0 204 116 404
000 396 722 6	0 204 116 403

000 396 722 7	0 204 116 402
000 396 772 5	0 204 131 717
000 398 133 6	F 026 003 180
000 398 133 6	0 204 123 180
000 398 200 2	0 204 122 112

005 312 593	1 987 476 645
021 167 320 A	1 987 482 047
021 715 003 A	F 026 003 180
021 715 003 A	0 204 123 180
021 905 377	0 261 231 047

◀VW

021 905 377 A	0 261 231 064	1H1 721 401 A	0 986 486 038	1K0 609 721 AA	1 987 477 958	113 611 015 BP	0 986 480 418
022 167 320 A	1 987 482 047	1H1 721 401 B	0 986 486 038	1K0 609 721 Q	1 987 477 802	113 611 015 C	0 986 480 415
026 905 377	0 261 231 002	1H2 612 107	0 986 485 111	1K0 609 721 S	1 987 477 802	113 611 015 D	0 986 480 415
026 905 377	0 261 231 006	1H2 612 107 B	0 986 485 111	1K0 609 721 T	1 987 477 957	113 611 015 F	0 986 480 075
028 168 700 A	0 204 131 716	1H2 612 107 D	0 986 485 111	1K0 611 701	1 987 476 397	113 611 015 G	0 986 480 075
028 715 004 B	0 204 122 112	1H2 698 019	0 986 480 869	1K0 611 701 B	1 987 476 282	113 611 015 H	0 986 480 415
030 905 377	0 261 231 066	1H2 721 401	0 986 486 045	1K0 611 775 A	1 987 476 284	113 611 015 J	0 986 480 415
030 905 377 A	0 261 231 045	1J0 609 721 AC	1 987 477 698	1K0 611 775 C	1 987 476 284	113 611 015 L	0 986 480 075
030 905 377 C	0 261 231 146	1J0 609 721 AC	1 987 477 817	1K0 721 261	0 986 486 576	113 611 015 M	0 986 480 075
030 905 377 1	0 261 231 122	1J0 609 721 AD	1 987 477 698	1K0 721 261 A	0 986 486 576	113 611 015 N	0 986 480 075
034 905 377 A	0 261 231 004	1J0 609 721 AP	1 987 477 698	1K0 721 261 B	0 986 486 576	113 611 015 P	0 986 480 418
034 905 377 C	0 261 231 016	1J0 609 721 E	1 987 477 696	1K0 721 261 C	0 986 486 576	113 611 015 R	0 986 480 418
034 905 377 D	0 261 231 014	1J0 609 721 E	1 987 477 697	1K0 721 261 F	0 986 486 576	113 611 017	0 986 480 415
034 905 377 H	0 261 231 031	1J0 609 721 G	1 987 482 129	1K0 721 261 G	0 986 486 576	113 611 017 A	0 986 480 415
037 905 377	0 261 231 075	1J0 609 721 H	1 987 477 696	1K0 721 261 H	0 986 486 576	113 611 017 B	0 986 480 415
037 905 377 A	0 261 231 077	1J0 609 721 J	1 987 477 684	1K0 721 261 J	0 986 486 576	113 611 017 C	0 986 480 415
054 905 377	0 261 231 036	1J0 609 721 K	1 987 477 698	1K0 927 807	0 986 594 506	113 611 017 D	0 986 480 415
054 905 377 A	0 261 231 038	1J0 609 721 K	1 987 477 800	1K0 927 808	0 986 594 507	113 611 017 E	0 986 480 415
054 905 377 G	0 261 231 036	1J0 609 721 K	1 987 477 817	1K1 614 019	0 986 480 870	113 611 017 F	0 986 480 418
054 905 377 H	0 261 231 038	1J0 609 721 L	1 987 477 686	1K1 614 019 B	0 204 123 715	113 611 017 G	0 986 480 418
06B 905 377 B	0 261 231 202	1J0 609 721 R	1 987 477 686	1K1 614 019 F	0 204 123 715	113 611 017 H	0 986 480 418
077 905 377	0 261 231 019	1J0 609 721 S	1 987 477 684	1K1 614 106 A	0 204 024 943	113 611 017 J	0 986 480 415
077 905 377 A	0 261 231 040	1J0 609 721 S	1 987 477 685	1L0 609 721 A	1 987 477 167	113 611 017 K	0 986 480 415
1H0 609 721	1 987 477 168	1J0 609 721 T	1 987 477 698	1L0 609 721 B	1 987 477 167	113 611 017 L	0 986 480 418
1H0 609 721 A	1 987 477 162	1J0 611 701	1 987 476 648	1L0 611 701	1 987 476 851	113 611 017 M	0 986 480 415
1H0 609 721 B	1 987 482 124	1J0 611 701 D	1 987 476 849	1L0 611 701 A	1 987 476 851	113 611 053	0 986 475 774
1H0 609 721 D	1 987 477 338	1J0 611 701 E	1 987 476 849	1L0 612 107 A	0 204 125 243	113 611 053 A	0 986 475 264
1H0 609 721 E	1 987 477 393	1J0 611 701 F	1 987 481 183	1T0 609 721 D	1 987 477 891	113 611 053 B	0 986 475 264
1H0 611 053	0 986 475 433	1J0 611 701 G	1 987 476 849	1T0 609 721 E	1 987 477 891	113 611 701	1 987 476 446
1H0 611 053 A	0 986 475 438	1J0 611 775	1 987 476 952	1T0 609 721 F	1 987 477 891	113 611 701 C	1 987 476 324
1H0 611 053 B	0 986 475 290	1J0 698 721 AD	1 987 477 818	1T0 609 721 G	1 987 477 891	113 611 701 D	1 987 476 324
1H0 611 053 C	0 986 475 865	1J0 721 261 A	0 986 486 542	1T0 609 721 H	1 987 477 942	113 611 701 E	1 987 476 380
1H0 611 701	1 987 476 415	1J0 721 261 D	0 986 486 538	1T0 609 721 J	1 987 477 942	113 611 775	1 987 476 289
1H0 611 701 A	1 987 481 115	1J0 721 261 E	0 986 486 542	110 595 032	0 986 475 811	113 611 775 A	1 987 476 327
1H0 611 701 B	1 987 481 115	1J0 721 261 F	0 986 486 542	113 595 030	0 986 475 812	113 611 775 B	1 987 476 290
1H0 611 775	1 987 476 400	1J0 721 261 H	0 986 486 538	113 611 015	0 986 480 415	113 611 775 C	1 987 476 380
1H0 612 151	0 204 131 310	1J0 927 803	0 986 594 001	113 611 015 AC	0 986 480 076	113 611 775 D	1 987 476 290
1H0 612 151	0 986 482 007	1J0 927 804	0 986 594 000	113 611 015 AH	0 986 480 075	113 611 775 E	1 987 476 327
1H0 612 151 C	0 204 131 697	1J0 927 807 B	0 986 594 004	113 611 015 AM	0 986 480 076	113 611 781 D	1 987 476 289
1H0 612 151 D	0 204 131 310	1J0 927 807 D	0 986 594 008	113 611 015 AN	0 986 480 076	113 615 105 A	0 986 471 965
1H0 612 151 E	0 204 131 697	1J1 612 107 B	0 204 125 717	113 611 015 AQ	0 986 480 076	113 615 106 A	0 986 471 966
1H0 615 123 A	0 986 471 663	1J1 614 019	0 204 123 339	113 611 015 AR	0 986 480 418	113 615 107 B	0 986 471 965
1H0 615 124 A	0 986 472 663	1J1 614 106 C	0 204 125 490	113 611 015 AS	0 986 480 418	113 615 108 B	0 986 471 966
1H0 927 807	0 986 594 001	1J1 614 106 D	0 204 125 490	113 611 015 AT	0 986 480 076	114 595 012	0 986 480 630
1H0 927 807 D	0 986 594 003	1J1 614 106 E	0 204 125 718	113 611 015 B	0 986 480 415	114 611 015 BG	0 986 480 899
1H0 927 808	0 986 594 000	1J1 721 388 A	0 986 486 031	113 611 015 BC	0 986 480 415	114 611 015 BJ	0 986 480 899
1H1 611 019 A	F 026 003 562	1J1 721 388 C	0 986 486 031	113 611 015 BD	0 986 480 075	115 332 750	1 987 477 523
1H1 611 019 A	0 204 123 562	1J1 721 388 D	0 986 486 031	113 611 015 BE	0 986 480 415	115 332 751	1 987 477 523
1H1 611 019 B	F 026 003 563	1J1 721 388 E	0 986 486 031	113 611 015 BF	0 986 480 075	115 595 015	0 986 480 683
1H1 611 019 B	0 204 123 563	1J2 612 107	0 204 125 719	113 611 015 BG	0 986 480 418	115 595 030	0 986 475 812
1H1 611 019 C	F 026 003 562	1J2 614 019	0 204 123 406	113 611 015 BH	0 986 480 076	115 595 032	0 986 475 769
1H1 611 019 C	0 204 123 375	1J2 614 106 A	0 204 125 505	113 611 015 BJ	0 986 480 418	115 595 610	1 987 476 555
1H1 611 019 C	0 204 123 562	1J2 614 106 B	0 204 125 505	113 611 015 BK	0 986 480 076	115 595 612	1 987 476 646
1H1 698 019 A	0 986 480 878	1J2 721 388 A	0 986 486 047	113 611 015 BL	0 986 480 415	115 595 620	1 987 476 647
1H1 721 401	0 986 486 038	1J2 721 388 C	0 986 486 047	113 611 015 BN	0 986 480 418	115 595 621	1 987 476 647

116 595 030	0 986 475 865	171 698 181 H	1 987 472 282	2D0 612 503 A	0 204 131 251	251 611 021	0 204 123 029
131 611 701	1 987 476 324	171 698 181 L	1 987 472 282	2D0 612 503 B	0 204 131 249	251 611 021 A	0 986 480 445
133 609 721	1 987 477 036	172 611 019 A	0 986 480 430	2D0 612 503 C	0 204 131 250	251 611 021 C	0 204 123 029
171 609 721 C	1 987 477 039	175 609 721	1 987 477 039	2D0 614 111 C	0 265 220 489	251 611 021 F	0 986 480 445
171 611 015	0 986 480 426	175 611 701 A	1 987 476 217	2D0 615 423 B	0 204 102 918	251 611 021 G	0 986 480 445
171 611 015 A	0 986 480 427	175 611 775	1 987 476 220	2D0 615 424 B	0 204 102 919	251 611 021 K	0 986 480 641
171 611 015 AA	0 986 480 427	179 609 721	1 987 477 322	2D0 721 261	0 986 486 546	251 611 775	1 987 476 138
171 611 015 AD	0 986 480 426	191 609 721	1 987 477 046	2D0 721 261 A	0 986 486 546	251 611 775 A	1 987 476 138
171 611 015 AF	0 986 480 427	191 609 721 A	1 987 477 165	2D0 721 401	0 986 486 053	251 611 775 B	1 987 476 139
171 611 015 B	0 986 480 426	191 609 721 C	1 987 482 104	2D0 927 807	0 265 004 009	251 615 107	0 986 471 974
171 611 015 C	0 986 480 427	191 609 721 D	1 987 477 166	2D0 927 807 A	0 265 004 010	251 615 107 A	0 986 471 706
171 611 015 H	0 986 480 426	191 609 721 E	1 987 477 164	2D0 927 808	0 265 004 008	251 615 107 B	0 986 471 668
171 611 015 J	0 986 480 427	191 609 721 F	1 987 477 167	2D0 927 808 A	0 265 004 010	251 615 108	0 986 471 973
171 611 015 R	0 986 480 426	191 611 019	F 026 003 180	2E0 609 701 AA	1 987 482 034	251 615 108 A	0 986 472 706
171 611 015 S	0 986 480 427	191 611 019	0 204 123 180	2E0 609 701 J	1 987 482 032	251 615 108 B	0 986 472 668
171 611 015 T	0 986 480 426	191 611 701	1 987 476 217	2E0 609 701 L	1 987 482 028	251 615 123 B	0 986 471 668
171 611 019	0 986 480 428	191 611 701 A	1 987 476 450	2E0 609 701 M	1 987 482 029	251 615 123 D	0 986 471 668
171 611 019 A	0 986 480 429	191 612 107	0 986 485 093	2E0 609 701 P	1 987 482 030	251 615 124 B	0 986 472 668
171 611 019 B	0 986 480 428	191 612 107 A	0 986 485 058	2E0 609 701 Q	1 987 482 031	251 615 124 D	0 986 472 668
171 611 019 C	0 986 480 429	191 612 151	0 204 031 291	2E0 609 701 T	1 987 482 033	251 698 201 C	1 987 472 294
171 611 019 D	0 986 480 428	191 612 151	0 986 482 006	2E0 611 017	0 204 255 049	251 721 263	0 986 486 507
171 611 019 E	0 986 480 429	191 612 151 C	0 986 482 006	2E0 611 017 C	0 204 051 514	251 721 263 A	0 986 486 507
171 611 019 H	0 986 480 430	191 615 123	0 204 102 373	2E0 612 107	0 204 051 341	251 721 401	0 986 486 002
171 611 019 N	0 986 480 430	191 615 123	0 204 102 940	2E0 614 117	0 265 234 098	251 721 401 A	0 986 486 002
171 611 051 B	0 986 475 290	191 615 124	0 204 102 374	2E0 614 117 A	0 265 234 100	251 721 401 F	0 986 486 002
171 611 053	0 986 475 290	191 615 423	0 986 471 673	2E0 907 637	0 265 005 628	251 907 379	0 265 103 023
171 611 053 A	0 986 475 290	191 615 423 A	0 986 471 664	2E0 909 052 EK	0 265 235 028	251 927 807	0 265 001 149
171 611 701 B	1 987 476 339	191 615 423 B	0 986 471 673	2E3 609 701 A	1 987 482 027	251 927 807 B	0 265 001 196
171 611 701 D	1 987 476 336	191 615 424	0 986 472 673	2E3 609 701 R	1 987 482 027	251 927 808	0 265 001 198
171 611 701 G	1 987 476 217	191 615 424 A	0 986 472 664	2K0 609 721 E	1 987 477 203	281 611 011	0 986 480 450
171 611 701 K	1 987 476 337	191 615 424 B	0 986 472 673	2K0 611 775 C	1 987 476 398	281 611 011 A	0 986 480 079
171 611 701 L	1 987 476 217	191 927 807 A	0 986 594 012	2P0 611 555 C	0 204 032 975	281 611 011 D	0 986 480 079
171 611 775	1 987 476 220	2D0 609 701	1 987 477 853	211 611 021 AE	0 986 480 442	281 611 047	0 986 475 475
171 612 107 G	0 986 485 101	2D0 609 701 A	1 987 477 854	211 611 021 AG	0 986 480 442	281 611 771	1 987 476 352
171 615 107 A	0 986 471 652	2D0 609 701 B	1 987 477 855	211 611 021 AJ	0 986 480 442	281 611 771 A	1 987 476 352
171 615 107 A	0 986 471 705	2D0 609 701 C	1 987 482 131	211 611 047 D	F 026 002 305	281 611 771 C	1 987 476 235
171 615 107 C	0 986 471 652	2D0 609 701 D	1 987 477 880	211 611 047 D	0 204 116 305	281 611 775	1 987 476 380
171 615 107 C	0 986 471 705	2D0 609 721	1 987 477 852	211 611 047 E	F 026 002 305	281 611 775 B	1 987 476 380
171 615 107 D	0 986 471 652	2D0 609 721 A	1 987 477 859	211 611 047 E	0 204 116 305	281 612 105	0 986 485 103
171 615 107 F	0 986 471 652	2D0 609 722	1 987 477 858	211 611 047 F	F 026 002 305	281 614 111 B	0 265 205 013
171 615 107 F	0 986 471 705	2D0 611 019	0 204 123 483	211 611 047 F	0 204 116 305	281 698 211	1 987 472 178
171 615 108 A	0 986 472 652	2D0 611 019 A	F 026 003 484	211 611 775 A	1 987 476 290	281 698 211 B	1 987 472 178
171 615 108 A	0 986 472 705	2D0 611 019 B	0 204 123 483	211 611 775 B	1 987 476 289	281 698 471	1 987 470 487
171 615 108 C	0 986 472 652	2D0 611 019 C	F 026 003 484	211 611 775 C	1 987 476 348	291 611 047	0 986 475 476
171 615 108 C	0 986 472 705	2D0 611 019 D	0 204 123 370	211 611 775 R	1 987 476 289	291 611 047 A	0 986 475 614
171 615 108 D	0 986 472 652	2D0 611 019 D	0 204 123 485	211 615 107 A	0 986 471 974	291 611 047 B	0 986 475 614
171 615 108 F	0 986 472 652	2D0 611 701	1 987 476 295	211 615 108 A	0 986 471 973	3A0 609 721	1 987 477 407
171 615 108 F	0 986 472 705	2D0 611 701 B	1 987 476 295	251 609 701	1 987 477 040	3A0 609 721 A	1 987 477 406
171 615 123	0 986 471 663	2D0 611 701 D	1 987 481 020	251 609 701 A	1 987 477 040	3A0 609 721 B	1 987 477 407
171 615 123 B	0 986 471 663	2D0 611 775	1 987 481 003	251 609 701 B	1 987 477 040	3A0 609 721 C	1 987 477 406
171 615 124	0 986 472 663	2D0 611 775 A	1 987 481 008	251 609 701 C	1 987 477 040	3A0 611 053	0 986 475 039
171 615 124 B	0 986 472 663	2D0 612 101 J	0 204 125 741	251 609 701 D	1 987 482 215	3A0 611 701	1 987 476 696
171 698 181 A	1 987 472 282	2D0 612 105 A	0 204 125 741	251 609 701 E	1 987 482 217	3A0 615 123	0 986 471 923
171 698 181 E	1 987 472 195	2D0 612 105 B	0 204 125 741	251 609 701 F	1 987 482 218	3A0 615 124	0 986 471 924
171 698 181 G	1 987 472 181	2D0 612 503	0 204 131 248	251 609 702	1 987 482 216	3A1698019	0 986 480 987

◀ VW

3A1 721 388	0 986 486 041	322 611 019 A	0 986 480 836	4A0 609 721 E	1 987 477 063	4B0 614 517 K	0 265 225 122
3BD 609 721	1 987 477 244	325 612 105 1	0 204 032 352	4A0 609 721 F	1 987 477 064	4B0 614 517 S	0 265 225 125
3BD 609 721 A	1 987 477 244	325 612 105 2	0 204 032 370	4A0 611 019	0 986 480 911	4B0 614 517 S	0 265 225 182
3BD 609 721 C	1 987 477 244	325 612 107 2	0 204 0A2 182	4A0 611 019 A	0 986 480 832	4B0 614 517 T	0 265 225 122
3BD 609 722	1 987 477 242	331 611 051	0 986 475 260	4A0 611 019 B	0 986 480 829	4B0 614 517 T	0 265 225 179
3BD 609 722 A	1 987 477 242	331 611 051 A	0 986 475 260	4A0 611 019 C	0 986 480 911	4B0 907 637	0 265 005 214
3BD 609 722 C	1 987 477 242	331 611 053	0 986 475 260	4A0 611 019 D	0 986 480 832	4B0 907 637 A	0 265 005 214
3B0 609 721 F	1 987 477 803	331 611 053 A	0 986 475 260	4A0 611 019 E	0 986 480 829	4B0 927 803	0 986 594 006
3B0 609 721 K	1 987 477 803	331 611 053 B	0 986 475 260	4A0 611 021	0 986 480 829	4B0 927 803 B	0 265 006 578
3B0 609 721 L	1 987 477 803	331 612 151	0 204 031 319	4A0 611 021 A	0 986 480 832	4B0 927 803 C	0 986 594 007
3B0 609 722 F	1 987 477 804	331 612 151	0 204 131 026	4A0 611 021 B	0 986 480 911	4B0 927 803 E	0 265 006 765
3B0 609 722 K	1 987 477 804	331 615 107 C	0 986 471 686	4A0 611 021 D	0 986 480 832	4B0 927 803 F	0 265 006 655
3B0 927 807 G	0 265 006 573	331 615 108 C	0 986 472 686	4A0 611 021 E	0 986 480 833	4B0 927 807 E	0 265 006 565
3B0 927 807 H	0 265 006 575	333 612 151	0 204 131 050	4A0 611 707	1 987 476 404	4B0 927 807 F	0 265 006 567
3C0 611 701 B	1 987 481 173	333 612 151 A	0 204 131 058	4A0 611 755 B	1 987 476 302	4B0 927 807 J	0 265 006 565
3C0 611 701 C	1 987 481 184	357 609 721	1 987 477 169	4A0 611 775	1 987 476 418	4B0 927 807 J	0 265 006 584
3C0 611 701 H	1 987 481 173	357 609 721 A	1 987 477 321	4A0 611 775 B	1 987 476 302	4B0 927 807 K	0 265 006 567
3C0 611 701 J	1 987 481 184	357 609 721 C	1 987 477 207	4A0 612 107 A	0 986 485 131	4B0 927 807 K	0 265 006 586
3C0 611 775	1 987 476 101	357 609 721 D	1 987 477 321	4A0 614 111 A	0 265 201 050	4B0 927 807 M	0 265 006 664
3D0 614 517 AA	0 265 225 053	357 609 721 E	1 987 477 321	4A0 614 111 C	0 265 211 006	4B0 927 807 N	0 265 006 767
3D0 614 517 AA	0 265 225 238	357 611 019	F 026 003 562	4A0 614 111 D	0 265 201 050	4B0 927 807 P	0 265 006 769
3D0 614 517 AC	0 265 225 056	357 611 019	0 204 123 562	4A0 614 111 F	0 265 211 006	4B0 927 807 Q	0 265 006 761
3D0 614 517 AG	0 265 225 056	357 611 019 B	F 026 003 563	4A0 614 111 G	0 265 218 013	4B0 927 807 R	0 265 006 763
3D0 614 517 AL	0 265 225 238	357 611 019 B	0 204 123 563	4A0 614 111 H	0 265 218 013	4B0 927 807 S	0 265 006 771
3D0 614 517 L	0 265 225 238	357 611 053 B	0 986 475 039	4A0 615 123	0 986 471 929	4D0 609 721 H	1 987 477 881
3D0 614 517 T	0 265 225 238	357 612 107	0 986 485 107	4A0 615 124	0 986 471 930	4D0 609 721 K	1 987 477 881
3U0 614 517 C	0 265 225 141	357 612 107 A	0 986 485 107	4A0 615 423	0 986 471 695	4D0 609 721 N	1 987 482 126
3U0 614 517 E	0 265 225 141	357 612 151	0 986 482 006	4A0 615 424	0 986 472 695	4D0 609 722 H	1 987 477 882
305 611 015 A	0 204 032 598	357 612 151 A	0 986 482 006	4A0 721 261	0 986 486 532	4D0 609 722 K	1 987 477 882
305 612 105 A	0 204 0A2 431	357 615 123	0 986 471 663	4A0 721 401	0 986 486 024	4D0 611 021	0 986 480 935
309 611 051	0 986 475 260	357 615 123 A	0 986 471 669	4A0 907 379	0 265 103 051	4D0 611 021 A	0 986 480 935
309 611 051 1	0 986 475 260	357 615 123 C	0 986 471 687	4A0 907 379 A	0 265 100 057	4D0 611 021 B	0 986 480 966
309 611 053	0 986 475 260	357 615 124	0 986 472 663	4A0 907 379 D	0 265 103 062	4D0 611 707 D	1 987 476 856
309 611 053 1	0 986 475 260	357 615 124 A	0 986 472 669	4A0 927 843	0 332 205 004	4D0 611 707 F	1 987 476 856
311 611 701 A	1 987 476 324	357 615 124 C	0 986 472 687	4B0 609 721 AC	1 987 477 603	4D0 611 775 D	1 987 481 082
311 611 776	1 987 476 327	357 721 261	0 986 486 537	4B0 609 721 AD	1 987 477 959	4D0 611 775 G	1 987 481 082
321 609 721	1 987 477 037	357 721 261 A	0 986 486 537	4B0 609 721 M	1 987 477 603	4D0 614 111 B	0 265 218 008
321 609 721 A	1 987 477 037	357 721 261 B	0 986 486 537	4B0 609 721 N	1 987 477 959	4D0 614 111 F	0 265 218 016
321 609 721 C	1 987 477 041	357 721 401	0 986 486 006	4B0 609 721 Q	1 987 477 604	4D0 614 111 G	0 265 218 016
321 611 019	0 986 480 434	358 612 107	0 986 485 110	4B0 609 721 R	1 987 477 603	4D0 614 111 J	0 265 220 437
321 611 019 A	0 986 480 433	376 927 807	0 265 006 643	4B0 609 721 S	1 987 477 959	4D0 907 379 D	0 265 108 005
321 611 019 D	0 986 480 434	376 927 807 A	0 265 006 645	4B0 609 722 L	1 987 477 604	4D0 907 379 G	0 265 109 002
321 611 019 E	0 986 480 433	377 611 015 A	0 204 032 600	4B0 609 722 N	1 987 477 604	4D0 907 389	0 265 109 400
321 611 019 N	0 986 480 141	377 612 103 AQ	0 204 032 384	4B0 611 755 C	1 987 476 308	4D0 907 389 B	0 265 109 444
321 611 053 A	0 986 475 260	377 612 103 G	0 204 0A2 375	4B0611775	1 987 476 010	4D0 907 389 C	0 265 109 443
321 611 701 B	1 987 476 217	377 614 111 B	0 265 216 039	4B0 611 775 A	1 987 476 308	4D0 907 389 D	0 265 109 461
321 611 701 F	1 987 476 214	377 927 807	0 265 006 218	4B0 611 775 B	1 987 476 308	4D0 907 389 E	0 265 109 460
321 611 775	1 987 476 216	377 927 807 B	0 265 006 222	4B0 611 775 C	1 987 476 308	4D0 907 389 F	0 265 109 474
321 611 775 A	1 987 476 220	377 927 807 C	0 265 006 221	4B0 614 517 AB	0 265 225 088	4D0 907 571	0 265 005 401
321 615 107 C	0 986 472 652	377 927 807 D	0 265 006 410	4B0 614 517 AB	0 265 225 205	4D0 907 657	0 265 005 207
321 615 123	0 986 471 709	377 927 807 F	0 265 006 411	4B0 614 517 AC	0 265 225 169	4D0 927 803 B	0 265 006 580
321 615 123 A	0 986 471 663	379 612 103	0 204 0A2 181	4B0 614 517 B	0 265 225 050	4D0 927 803 C	0 265 006 580
321 615 124	0 986 472 709	4A0 609 721 B	1 987 477 063	4B0 614 517 C	0 265 225 047	4D0 927 803 D	0 265 006 580
321 615 124 A	0 986 472 663	4A0 609 721 C	1 987 477 064	4B0 614 517 F	0 265 225 088	4D0 927 803 E	0 265 006 662
322 611 019	0 986 480 080	4A0 609 721 D	1 987 477 687	4B0 614 517 J	0 265 225 125	4D0 927 807 B	0 265 006 588

4EO 611 775 F	1 987 476 018	431 721 401	0 986 486 024	443 615 124 F	0 986 472 712	6K1 612 107 G	0 204 125 262
4EO 614 517 AD	0 265 225 318	431 721 401 A	0 986 486 024	443 615 407	0 986 471 711	6K1721401	0 986 486 109
4EO 614 517 AE	0 265 225 374	433 611 707	1 987 476 278	443 615 408	0 986 472 711	6K2 611 019 C	0 204 123 521
4EO 614 517 AN	0 265 225 329	433 611 775	1 987 476 222	443 615 423	0 986 471 711	6K2 611 019 E	0 204 024 054
4EO 614 517 AR	0 265 225 353	433 611 775 A	1 987 476 216	443 615 423 A	0 986 471 693	6K2 612 107 F	0 204 125 264
4EO 614 517 B	0 265 225 137	437 609 721 A	1 987 477 183	443 615 424	0 986 472 711	6K2 612 107 G	0 204 125 263
4EO 614 517 BE	0 265 225 137	437 609 722 A	1 987 477 184	443 615 424 A	0 986 472 693	6K2 612 107 J	0 204 024 055
4EO 614 517 BF	0 265 225 296	437 611 019	0 986 480 363	443 721 261	0 986 486 529	6K2 698 019	0 204 123 521
4EO 614 517 BG	0 265 225 318	437 611 019 A	0 986 480 363	443 721 401 A	0 986 486 024	6K2 698 019 A	0 204 123 520
4EO 614 517 BJ	0 265 225 350	437 611 775	1 987 476 230	443 907 379 C	0 265 100 038	6K9 609 721	1 987 477 626
4EO 614 517 BP	0 265 225 406	437 614 111	0 265 201 012	443 907 379 E	0 265 100 036	6K9 611 776	1 987 476 169
4EO 614 517 BS	0 265 225 409	437 615 421 A	0 986 471 713	443 927 803 A	0 265 001 039	6K9 612 151	0 204 031 290
4EO 614 517 C	0 265 225 134	437 615 422 A	0 986 472 713	443 927 807 A	0 265 001 060	6K9 612 151	0 204 131 363
4EO 614 517 CB	0 265 225 374	437 615 423	0 986 471 850	447 611 021	0 986 480 914	6N0 609 721	1 987 477 284
4EO 614 517 K	0 265 225 202	437 615 423 A	0 986 471 850	447 615 123	0 986 471 713	6N0 609 721	1 987 477 285
4EO 614 517 L	0 265 225 199	437 615 424	0 986 471 851	447 615 124	0 986 472 713	6N0 609 721 A	1 987 477 284
4EO 614 517 L	0 265 225 296	437 615 424 A	0 986 471 851	447 615 423	0 986 471 694	6N0 609 721 A	1 987 477 285
4EO 614 517 R	0 265 225 296	438 611 021	0 986 480 363	447 615 424	0 986 472 694	6N0 609 721 B	1 987 477 284
4EO 614 517 S	0 265 225 199	438 611 021 A	0 986 480 363	447 698 471	1 987 470 023	6N0 609 721 E	1 987 477 284
4EO 614 517 S	0 265 225 296	441 609 721 D	1 987 477 813	477 611 055 E	0 986 475 454	6N0 609 721 E	1 987 477 285
4EO 927 803	0 265 007 408	441 609 722 D	1 987 477 815	481 611 775	1 987 476 230	6N0 609 721 G	1 987 477 284
4EO 927 803	0 265 007 728	441 611 021	0 986 480 826	481 611 776	1 987 476 220	6N0 609 721 G	1 987 477 285
4EO 927 803 A	0 265 007 728	441 611 021 A	0 986 480 826	5UZ612151	0 204 0C2 430	6N0 609 721 H	1 987 477 627
4EO 927 803 D	0 265 007 930	441 611 021 B	0 986 480 943	5X0 612 105	0 204 0A2 389	6N0 609 721 J	1 987 477 679
4EO 927 804	0 265 007 406	443 609 721	1 987 477 060	5X0 612 107 B	0 204 032 835	6N0 609 721 K	1 987 477 695
4EO 927 804 A	0 265 007 726	443 609 721 A	1 987 477 061	5Z0 611 891	0 204 2D2 241	6N0 609 721 L	1 987 477 627
4EO 927 804 D	0 265 007 928	443 609 721 E	1 987 477 062	5Z0 614 117 A	0 265 222 038	6N0 609 721 M	1 987 477 627
4FO 611 707	1 987 476 247	443 609 721 F	1 987 477 060	5Z0 614 117 C	0 265 231 628	6N0 611 053	0 986 475 260
4FO 611 775	1 987 476 293	443 609 721 G	1 987 477 062	5Z0 614 117 C	0 265 232 294	6N0 611 701	1 987 476 696
4FO 611 775 D	1 987 476 293	443 609 721 K	1 987 477 060	5Z0 614 117 L	0 265 232 294	6N0 611 701 A	1 987 476 696
4FO 614 517 AB	0 265 235 102	443 611 019	0 986 480 467	5Z0 614 517 A	0 265 234 256	6N0 611 701 B	1 987 476 696
4FO 614 517 AC	0 265 235 105	443 611 019 A	0 986 480 467	5Z0 614 517 A	0 265 234 411	6N0 611 775 A	1 987 476 697
4FO 614 517 F	0 265 234 116	443 611 021	0 986 480 440	5Z0 614 517 A	0 265 234 722	6N0 612 123	0 204 102 624
4FO 614 517 G	0 265 234 113	443 611 707	1 987 476 278	5Z0 614 517 C	0 265 234 411	6N0 614 019	0 986 480 869
4FO 614 517 H	0 265 234 208	443 611 707 C	1 987 476 140	5Z0 614 517 C	0 265 234 722	6N0 615 123	0 204 102 624
4FO 614 517 J	0 265 234 211	443 611 775	1 987 476 226	5Z0 614 517 F	0 265 234 493	6N0 615 123 A	0 204 102 375
4FO 614 517 M	0 265 234 262	443 611 775 A	1 987 476 224	5Z0 614 517 K	0 265 234 722	6N0 615 123 B	0 204 102 580
4FO 614 517 N	0 265 234 265	443 611 775 B	1 987 476 141	5Z1 612 106 B	0 204 0C2 082	6N0 615 124	0 204 004 658
4FO 907 637	0 265 005 601	443 611 775 C	1 987 476 278	5Z1 612 106 C	0 204 0C2 083	6N0 615 124 A	0 204 102 376
4G0 907 637 D	0 265 200 027	443 611 775 F	1 987 476 142	5Z1 612 107 D	0 204 0C2 080	6N0 615 124 B	0 204 102 581
4G0 907 637 F	0 265 200 029	443 612 099 B	0 986 485 114	5Z1 612 107 E	0 204 0C2 081	6N0 927 807 A	0 986 594 009
4Z0 927 803 B	0 265 006 773	443 614 111	0 265 201 012	535 609 721 A	1 987 477 162	6N1 612 107 B	0 204 125 254
4Z7 611 775 A	1 987 481 091	443 614 151 A	0 986 482 008	535 611 701	1 987 476 410	6N2 612 107 B	0 204 125 516
4Z7 907 389	0 265 109 475	443 614 151 H	0 986 482 008	535 615 423	0 986 471 673	6QE 721 261	0 986 486 554
4Z7 907 389 A	0 265 109 613	443 615 107 B	0 986 471 921	535 615 424	0 986 472 673	6Q0 609 721 B	1 987 477 806
4Z7 927 807 C	0 265 006 655	443 615 108 B	0 986 471 922	547 612 105 A	0 204 0A2 179	6Q0 609 721 C	1 987 477 807
4Z7 927 807 E	0 265 006 657	443 615 123	0 986 471 669	547 614 113	0 265 216 416	6Q0 609 721 D	1 987 477 806
4Z7 927 807 F	0 265 006 781	443 615 123 A	0 986 471 712	6E0 611 701 A	1 987 481 143	6Q0 609 721 F	1 987 477 807
4Z7 927 807 G	0 265 006 783	443 615 123 B	0 986 471 915	6E0 611 701 C	1 987 481 143	6Q0 609 721 G	1 987 477 807
431 609 721	1 987 477 001	443 615 123 D	0 986 471 921	6H0 615 123 B	0 204 102 580	6Q0 609 721 H	1 987 477 806
431 609 721 D	1 987 477 001	443 615 123 F	0 986 471 712	6K0 609 721	1 987 477 214	6Q0 609 721 J	1 987 477 806
431 611 019 D	0 986 480 460	443 615 124	0 986 472 669	6K0 609 721 C	1 987 477 215	6Q0 609 721 K	1 987 482 191
431 611 019 H	0 986 480 460	443 615 124 A	0 986 472 712	6K0 609 721 E	1 987 477 204	6Q0 609 721 L	1 987 482 191
431 615 123 A	0 986 471 653	443 615 124 B	0 986 471 916	6K0 609 721 F	1 987 477 204	6Q0 609 721 M	1 987 477 205
431 721 261	0 986 486 529	443 615 124 D	0 986 471 922	6K0 611 701	1 987 476 415	6Q0 609 721 N	1 987 477 205

◀VW

6Q0 611 019	0 204 024 227
6Q0 611 019 A	0 204 024 229
6Q0 611 019 A	0 986 480 850
6Q0 611 019 B	0 204 024 223
6Q0 611 019 E	0 986 480 820

6Q0 611 019 F	0 204 024 227
6Q0 611 019 G	0 204 024 229
6Q0 611 019 J	0 204 024 225
6Q0 611 019 Q	0 986 480 820
6Q0 611 701 C	1 987 476 978

6Q0 611 701 E	1 987 476 978
6Q0 611 775 A	1 987 476 952
6Q0 611 775 B	1 987 476 952
6Q0 612 151	0 204 031 682
6Q0 612 151	0 204 131 682

6Q0 612 151 A	0 204 031 681
6Q0 612 151 A	0 204 131 681
6Q0 612 151 B	0 204 031 682
6Q0 612 151 C	0 204 031 681
6Q0 614 117 A	0 265 222 008

6Q0 614 117 AB	0 265 231 720
6Q0 614 117 AB	0 265 231 947
6Q0 614 117 AB	0 265 232 278
6Q0 614 117 AD	0 265 231 723
6Q0 614 117 AD	0 265 232 281

6Q0 614 117 AK	0 265 232 246
6Q0 614 117 AM	0 265 232 249
6Q0 614 117 M	0 265 231 436
6Q0 614 117 P	0 265 231 570
6Q0 614 117 R	0 265 231 436

6Q0 614 117 T	0 265 231 714
6Q0 614 117 T	0 265 232 246
6Q0 614 417 A	0 265 224 013
6Q0 614 417 AA	0 265 231 729
6Q0 614 417 AA	0 265 232 287

6Q0 614 417 AG	0 265 232 252
6Q0 614 417 AJ	0 265 232 255
6Q0 614 417 F	0 265 224 013
6Q0 614 417 J	0 265 231 435
6Q0 614 417 J	0 265 231 717

6Q0 614 417 J	0 265 232 252
6Q0 614 417 L	0 265 231 656
6Q0 614 417 L	0 265 232 255
6Q0 614 417 N	0 265 231 435
6Q0 614 417 N	0 265 231 717

6Q0 614 417 N	0 265 232 252
6Q0 614 417 Q	0 265 231 717
6Q0 614 417 Q	0 265 232 252
6Q0 614 417 S	0 265 231 726
6Q0 614 417 S	0 265 231 950

6Q0 614 417 S	0 265 232 284
6Q0 614 517 A	0 265 225 081
6Q0 614 517 A	0 265 225 162
6Q0 614 517 AB	0 265 234 366
6Q0 614 517 AB	0 265 234 577

6Q0 614 517 AB	0 265 234 714
6Q0 614 517 AD	0 265 234 369
6Q0 614 517 AD	0 265 234 717
6Q0 614 517 AF	0 265 234 399
6Q0 614 517 AF	0 265 234 700

6Q0 614 517 AH	0 265 234 402
6Q0 614 517 AH	0 265 234 703
6Q0 614 517 AK	0 265 234 700
6Q0 614 517 AM	0 265 234 703
6Q0 614 517 AP	0 265 234 700

6Q0 614 517 AR	0 265 234 703
6Q0 614 517 B	0 265 225 081
6Q0 614 517 B	0 265 225 162
6Q0 614 517 C	0 265 225 162
6Q0 614 517 H	0 265 234 119

6Q0 614 517 L	0 265 225 162
6Q0 614 517 Q	0 265 234 226
6Q0 614 517 Q	0 265 234 402
6Q0 614 517 Q	0 265 234 703
6Q0 614 517 T	0 265 234 363

6Q0 698 117	0 265 222 008
6Q0 698 417	0 265 224 013
6Q0 721 261	0 986 486 553
6Q0 721 261 A	0 986 486 554
6Q0 721 261 C	0 986 486 553

6Q0 721 261 D	0 986 486 554
6Q0 721 261 F	0 986 486 554
6Q0 721 388	0 986 486 060
6Q0 721 388 A	0 986 486 060
6Q0 721 388 C	0 986 486 060

6Q0 907 637 A	0 265 005 692
6Q0 927 803 B	0 986 594 500
6Q0 927 804 B	0 986 594 501
6Q0 927 807 B	0 986 594 502
6Q0 927 808 B	0 986 594 503

6Q1 612 107 K	0 204 0A2 426
6Q1 614 106 L	0 204 0A2 390
6Q7 609 721 C	1 987 482 193
6Q7 609 721 E	1 987 482 193
6R0 614 117 E	0 265 231 947

6R0 614 117 E	0 265 232 278
6R0 614 117 G	0 265 232 278
6R0 614 117 J	0 265 232 281
6R0 614 417 A	0 265 231 950
6R0 614 417 A	0 265 232 284

6R0 614 417 E	0 265 232 284
6R0 614 417 G	0 265 232 287
6R0 614 517 C	0 265 234 577
6R0 614 517 C	0 265 234 714
6R0 614 517 L	0 265 234 714

6R0 614 517 N	0 265 234 717
6U0 611 019	0 986 480 682
6U0 611 053 A	0 986 475 865
6U0 611 053 B	0 986 475 769
6U0 611 701 B	1 987 476 317

6U0 611 775	1 987 476 012
6U0 611 775 A	1 987 476 012
6U0 611 775 B	1 987 476 012
6U0 612 151 A	0 204 131 310
6U0 612 151 A	0 986 482 007

6U7 607 721	1 987 477 680
6U7 609 721	1 987 477 690
6X0 609 721 C	1 987 477 883
6X0 609 721 D	1 987 477 705
6X0 609 721 E	1 987 477 705

6X0 609 721 F	1 987 477 680
6X0 609 721 H	1 987 477 680
6X0 611 775	1 987 476 952
6X0 615 123	0 204 102 920
6X0 615 124	0 204 102 921

7D0 609 701	1 987 477 706
7D0 609 701 B	1 987 477 707
7D0 609 701 E	1 987 477 707
7D0 609 701 F	1 987 477 707
7D0 611 701 C	1 987 476 698

7D0 611 701 E	1 987 476 698
7D0 611 775 C	1 987 481 092
7D0 612 503	0 204 031 292
7D0 614 111	0 265 220 434
7D0 614 111 C	0 265 220 434

7D0 614 111 E	0 265 202 454
7D0 615 423 A	0 986 472 832
7D0 615 423 B	0 986 472 832
7D0 615 424 A	0 986 472 833
7D0 615 424 B	0 986 472 833

7D0 907 379	0 265 109 602
7D0 907 379 A	0 265 109 602
7D0 907 379 B	0 265 109 602
7D0 907 379 C	0 265 109 602
7D0 907 379 D	0 265 109 602

7D0 907 379 E	0 265 109 612
7D0 907 379 F	0 265 109 602
7D0 907 379 G	0 265 109 612
7D0 907 389 B	0 265 109 602
7D0 927 807	0 265 006 508

7D0 927 808	0 265 006 510
7D2 614 111 A	0 265 220 045
7H0 609 701 D	1 987 477 260
7H0 611 701 B	1 987 481 182
7H0 611 701 C	1 987 481 182

7H0 611 775	1 987 476 309
7H0 611 776	1 987 476 310
7H0 927 803	0 986 594 504
7H0 927 804	0 986 594 505
7H1 609 701 F	1 987 482 016

7H3 609 701 H	1 987 482 017
7H8 609 701 G	1 987 482 014
7H8 611 776	1 987 476 320
7H8 611 779	1 987 476 313
7J3 609 701	1 987 482 015

7L0 609 721 A	1 987 482 018
7L0 611 019 E	0 986 480 992
7L0 611 701 A	1 987 476 325
7L0 611 776	1 987 476 330
7L0 611 776 A	1 987 476 330

7L0 721 556	1 987 482 192
7L0 721 556 A	1 987 482 187
7L0 721 556 C	1 987 482 187
7L6 611 701 A	1 987 481 174
7L6 611 776	1 987 481 175

7M0 609 701 B	1 987 477 630
7M0 611 019	0 986 480 933
7M0 611 701 D	1 987 476 713
7M0 611 775 E	1 987 476 714
7M0 611 776 B	1 987 476 715

7M0 611 776 C	1 987 476 715
7M0 615 423	0 986 471 846
7M0 615 424	0 986 471 847
7M0 711 472 A	1 987 477 833
7M0 721 401 A	0 986 486 050

7M0 721 401 B	0 986 486 050
7M0 721 401 C	0 986 486 050
7M0 721 401 D	0 986 486 050
7M0 927 807 C	0 986 594 010
7M0 927 807 D	0 986 594 011

7M1 611 019	0 986 480 930
7M3 611 701	1 987 476 170
7M3 611 701 A	1 987 476 170
7M3 611 701 B	1 987 476 170
7M3 721 401	0 986 486 050

701 609 701	1 987 477 171
701 611 019	0 986 480 834
701 611 047	F 026 002 567
701 611 047	0 204 116 567
701 611 701	1 987 476 411

701 611 701 A	1 987 476 698
701 612 105 B	0 986 485 112
701 612 503	0 204 031 292
701 612 503 A	0 204 031 292
701 612 503 C	0 204 031 292

701 614 111	0 265 201 038
701 614 111 A	0 265 201 038
701 614 111 F	0 265 220 010
701 615 123	0 986 471 703
701 615 123 C	0 986 471 806

701 615 124	0 986 472 703
701 615 124 C	0 986 471 807
701 615 124 D	0 986 472 703
701 615 423	0 986 472 834
701 615 424	0 986 472 835

701 721 401	0 986 486 037
701 721 401 B	0 986 486 048
701 907 379 A	0 265 100 072
701 927 807 A	0 265 006 407
701 927 807 C	0 986 594 013

701 927 807 D	0 265 006 409	8E0 609 721 AG	1 987 477 922	8E0 614 517 B	0 265 225 050	8Z0 609 721 C	1 987 482 125
701 927 807 E	0 265 006 408	8E0 609 721 AH	1 987 477 922	8E0 614 517 BA	0 265 234 332	8Z0 609 721 F	1 987 477 808
701 927 807 F	0 265 006 407	8E0 609 721 AJ	1 987 477 257	8E0 614 517 BC	0 265 234 329	8Z0 609 721 G	1 987 482 125
702 611 019	0 986 480 834	8E0 609 721 AQ	1 987 477 922	8E0 614 517 BE	0 265 234 229	8Z0 609 722 C	1 987 477 808
721 611 047	0 986 475 935	8E0 609 721 AR	1 987 477 257	8E0 614 517 BG	0 265 234 338	8Z0 609 722 G	1 987 477 808
8A0 609 721 AE	1 987 477 884	8E0 609 721 AS	1 987 477 922	8E0 614 517 BJ	0 265 234 335	8Z0 611 707	1 987 476 945
8A0 609 721 AF	1 987 477 305	8E0 609 721 AT	1 987 477 257	8E0 614 517 C	0 265 225 047	8Z0 611 707 C	1 987 476 945
8A0 609 721 J	1 987 477 305	8E0 609 721 H	1 987 477 922	8E0 614 517 L	0 265 225 050	8Z0 611 775 A	1 987 476 946
8A0 609 721 S	1 987 477 304	8E0 609 721 L	1 987 477 922	8E0 614 517 M	0 265 225 047	8Z0 611 775 B	1 987 476 946
8A0 609 721 T	1 987 477 305	8E0 609 721 M	1 987 477 259	8E0 614 517 N	0 265 225 050	803 609 721 D	1 987 477 059
8A0 611 021	0 986 480 911	8E0 609 721 P	1 987 477 259	8E0 614 517 N	0 265 225 176	803 611 019	0 986 480 459
8A0 611 775	1 987 476 402	8E0 609 722 AF	1 987 477 923	8E0 614 517 P	0 265 225 047	803 611 051	0 986 475 772
8A0 611 775 A	1 987 476 458	8E0 609 722 AG	1 987 477 923	8E0 614 517 P	0 265 225 173	803 611 775	1 987 476 002
8A0 615 123	0 986 471 808	8E0 609 722 AH	1 987 477 923	8E0 614 517 R	0 265 225 241	810 611 707	1 987 476 235
8A0 615 124	0 986 471 809	8E0 609 722 AQ	1 987 477 923	8E0 615 423	0 986 472 830	811 609 721 B	1 987 477 187
8A0 615 423	0 986 471 854	8E0 609 722 AS	1 987 477 923	8E0 615 424	0 986 472 831	811 609 721 D	1 987 477 189
8A0 615 424	0 986 471 855	8E0 609 722 H	1 987 477 923	8E0 721 257 A	0 986 486 548	811 609 721 G	1 987 477 189
8D0 609 721 H	1 987 477 659	8E0 609 722 L	1 987 477 923	8E0 721 257 B	0 986 486 548	811 609 721 H	1 987 477 187
8D0 611 021 A	0 986 480 890	8E0 611 707	1 987 476 171	8E0 721 257 E	0 986 486 548	811 609 721 J	1 987 477 051
8D0 611 021 B	0 986 480 890	8E0 611 707 A	1 987 476 171	8E0 721 257 F	0 986 486 548	811 609 721 J	1 987 477 187
8D0 611 021 C	0 986 480 974	8E0 611 707 D	1 987 476 171	8E0 721 257 N	0 986 486 548	811 609 722	1 987 477 058
8D0 611 707	1 987 476 717	8E0 611 707 G	1 987 476 171	8E0 907 597	0 265 005 303	811 609 722 C	1 987 477 058
8D0 611 707 B	1 987 476 717	8E0 611 755 C	1 987 476 308	8E0 907 637 A	0 265 005 252	811 609 722 D	1 987 477 194
8D0 611 707 D	1 987 476 717	8E0 611 775	1 987 476 018	8E0 907 637 B	0 265 005 619	811 609 722 E	1 987 477 052
8D0 611 775 C	1 987 476 458	8E0 611 775 B	1 987 476 719	8E0 907 637 B	0 265 007 618	811 609 722 E	1 987 477 194
8D0 611 775 D	1 987 476 142	8E0 611 775 E	1 987 476 719	8E0 907 637 C	0 265 005 621	811 611 019	0 986 480 428
8D0 611 775 E	1 987 476 018	8E0 611 775 H	1 987 476 944	8E0 907 637 C	0 265 007 620	811 611 019 B	0 986 480 428
8D0 611 775 F	1 987 476 332	8E0 611 775 J	1 987 476 719	8E0 907 637 C	0 265 007 853	811 611 019 C	0 986 480 434
8D0 611 775 G	1 987 476 332	8E0 614 111 AA	0 265 202 403	8E0 927 803 A	0 265 006 683	811 611 019 D	0 986 480 428
8D0 611 775 J	1 987 476 332	8E0 614 111 AB	0 265 216 561	8E0 927 803 B	0 265 006 809	811 611 019 E	0 986 480 436
8D0 614 111	0 265 214 004	8E0 614 111 AC	0 265 216 561	8E0 927 807 B	0 265 006 681	811 611 019 L	0 986 480 425
8D0 614 111 E	0 265 218 022	8E0 614 111 AE	0 265 216 564	8E0 927 807 C	0 265 006 707	811 611 019 M	0 986 480 437
8D0 615 123	0 986 471 810	8E0 614 111 AH	0 265 220 527	8E0 927 807 E	0 265 006 826	811 611 019 N	0 986 480 438
8D0 615 124	0 986 471 811	8E0 614 111 AJ	0 265 220 527	8E0 927 807 F	0 265 006 828	811 611 019 Q	0 986 480 084
8D0 615 423	0 986 471 856	8E0 614 111 AL	0 265 220 530	8E0 927 807 G	0 265 006 824	811 611 775	1 987 476 219
8D0 615 424	0 986 471 857	8E0 614 111 AN	0 265 216 564	8E1 721 401	0 986 486 054	811 611 775 A	1 987 476 143
8D0 721 257	0 986 486 551	8E0 614 111 AQ	0 265 220 639	8E1 721 401 AF	0 986 486 061	811 612 107 B	0 986 485 102
8D0 907 389	0 265 109 427	8E0 614 111 AR	0 265 220 641	8E1 721 401 AG	0 986 486 054	811 614 151	0 986 482 003
8D0 907 389	0 265 109 463	8E0 614 111 AT	0 265 202 403	8E1 721 401 AJ	0 986 486 062	811 615 123	0 986 471 709
8D0 907 389 A	0 265 109 426	8E0 614 111 D	0 265 216 413	8E1 721 401 C	0 986 486 054	811 615 124	0 986 472 709
8D0 907 389 D	0 265 109 463	8E0 614 111 E	0 265 220 410	8E1 721 401 F	0 986 486 061	811 698 181	1 987 472 240
8D0 907 389 E	0 265 109 462	8E0 614 111 F	0 265 220 407	8E1 721 401 G	0 986 486 054	811 698 181 A	1 987 472 240
8D0 907 389 F	0 265 109 473	8E0 614 111 G	0 265 220 413	8E1 721 401 K	0 986 486 054	811 927 807	0 265 001 099
8D0 927 803	0 986 594 014	8E0 614 111 J	0 265 220 483	8E1 721 401 L	0 986 486 062	821 611 776	1 987 476 220
8D0 927 803 D	0 986 594 002	8E0 614 111 N	0 265 220 443	8E1 721 401 S	0 986 486 062	823 611 707	1 987 476 217
8D0 927 807 C	0 986 594 005	8E0 614 111 Q	0 265 220 440	8K0 614 517 BH	0 265 236 086	839 611 021	0 986 480 433
8D0 927 807 F	0 265 006 569	8E0 614 111 S	0 265 220 446	8K0 907 637 A	0 265 005 668	841 612 151	0 986 482 003
8D0 927 807 G	0 265 006 571	8E0 614 517 AA	0 265 234 110	8K0 907 637 B	0 265 005 670	843 611 021 A	0 986 480 434
8D0 927 807 H	0 265 006 693	8E0 614 517 AA	0 265 234 332	8N0 609 721 C	1 987 477 255	843 611 021 C	0 986 480 433
8D0 927 807 J	0 265 006 695	8E0 614 517 AM	0 265 234 338	8N0 609 721 E	1 987 477 249	843 611 021 D	0 986 480 434
8D1 721 401	0 986 486 083	8E0 614 517 AN	0 265 234 335	8N0 609 721 F	1 987 477 255	843 698 181 A	1 987 472 282
8D1 721 401 B	0 986 486 083	8E0 614 517 AR	0 265 234 110	8N0 609 721 G	1 987 477 249	843 698 181 H	1 987 472 282
8D2 611 021 A	0 986 480 989	8E0 614 517 AR	0 265 234 332	8N0 609 721 H	1 987 477 249	849 611 707 A	1 987 476 217
8E0 609 721 AD	1 987 477 259	8E0 614 517 AS	0 265 234 107	8N0 611 707 A	1 987 476 172	853 611 019	0 986 480 836
8E0 609 721 AF	1 987 477 922	8E0 614 517 AS	0 265 234 329	8Z0 609 721 B	1 987 477 808	853 611 019 A	0 986 480 836

09Z	For vehicles with 9 inch diameter brake disks
10Z	For vehicles with 10 inch diameter brake disks
14Z	Rim diameter 14 inch
15Z	Rim diameter 15 inch
16Z	Installation dimensions 160 x 25 mm
16Z	Rim diameter 16 inch
183	Installation dimensions 180 x 30 mm
1K2	Brake disk 300 x 32 mm
1K4	Brake disk 300 x 24 mm
1K8	Brake disk 280 x 28 mm
1KX	Brake disk 313 x 26 mm
1LM	Brake disk 239 x 12 mm
1LY	Brake disk 256 x 20 mm
1QR	Brake disk diameter 300 mm
222	Diameter 22.2 mm
228	Brake disk 280 x 22 mm
239	Brake disk 239 x 20 mm
254	Diameter 25.4 mm
256	Brake disk 256 x 13 mm
258	Brake disk 258 x 12 mm
266	Brake disk 260 x 12 mm
26D	Brake disk diameter 260 mm
272	Brake disk diameter 272 mm
27L	Length: 276 mm
280	Brake disk 280 x 12 mm
281	Brake disk 282 x 18 mm
282	Brake disk 282 x 25 mm
284	Brake disk 280 x 24 mm
285	Brake disk 288 x 15 mm
288	Brake disk 288 x 25 mm
294	Brake disk diameter 294 mm
2T0	For vehicles with 2 torsion bars
308	Brake disk 308 x 29.5 mm
30R	For vehicles with 3050 mm wheelbase
312	Brake disk diameter 312 mm
322	Brake disk 314 x 22 mm
326	Brake disk 300 x 26 mm
32T	For gross weight 3200 kg
333	Brake disk 333 x 32.5 mm
336	Brake disk diameter 336 mm
35L	Length: 355 mm
35T	For 3.5 t and 5 t vehicles
3T5	For vehicles with 3.5 t gross permissible weight
3TN	Not for vehicles with 3.5 t gross permissible weight
435	Length: 435 mm
4-K	For 4-channel system
4L0	4-hole rim
4SB	For vehicles with 4 disk brakes
4T5	For vehicles with 4.5 t gross permissible weight
4T0	For vehicles with 4 torsion bars
56T	For 5.5 t, 6 t and 6.5 t vehicles
5L0	5-hole rim
6L0	6-hole rim
A07	Dimensions of brake drum 10 x 2 1/4 inch
A08	Dimensions of brake drum 10 x 2 3/4 inch
AA	All-wheel drive
ABF	Asbestos-free
ABM	Note dimensions
ABO	For vehicles without ABS
ABS	For vehicles with ABS
AG	For vehicles with automatic transmission
AK	Automatic clutch
AKE	For AKEBONO system
ANO	Connection at top
ANU	Bottom connection
APD	For Automotive Products system
AS2	2 connections
AS3	3 connections
AS4	4 connections
ASF	Sealed beam replacement set, main beam
ATE	For ATE system (Teves)
ATJ	For Trekking version
ATN	Not for Trekking version
AU	Exterior
B12	Brake disk 238 x 12 mm
B17	Rim diameter 17 inch
B28	Brake disk diameter 280 mm
B30	Width: 30 mm
B82	Brake disk 238 x 8.2 mm
BAB	Brake hose at wheel brake cylinder/brake caliper
BDE	For Bendix Spain (BENDIBERICA)
BDM	Brake booster with twin diaphragm
BDS	With swivel seat
BHO	For official vehicles
BKV	For vehicles with brake booster
BMS	Brake hose with sheath
BO	Bosch, only as replacement for Bosch equipment
BOB	Brake caliper without disk brake pads
BRB	For Brembo system
BRD	Brake pipe system, diagonal configuration
BRV	Brake pipe system, vertical configuration
BSB	Brake caliper with disk brake pads
BSM	Brake disk with pre-assembled bearing
BSS	For vehicles with brake assistant
BSV	Brake caliper, four cylinders
BSY	For Bosch brake system
BTE	Brake drum not including mount
BTR	Brake drum including bearing
BTS	Brake disk with bearing and integrated sensor
BUS	For bus
BVA	With wear indicator
BWW	For Bosch and Bendix system, optional
BZU	Also order accessory set
CIT	For Citroen system
CSA	Product can also be ordered online "www.automotive-tradition.com"
D10	Diameter 180 mm
D20	Diameter 20.6 mm
D22	Diameter 22 mm
D23	Diameter 23.81 mm
D26	Brake disk diameter 266 mm
D27	Diameter 27 mm
D28	Diameter 28.5 mm
D30	Diameter 203 mm
DEP	For Delphi system
DM1	Dimensions of brake drum 203 x 37 mm
DM3	Dimensions of brake drum 228.6 mm x 42 mm
DMO	For Delco Moraine system
DOP	Twin cab
E66	Installation dimensions 270 x 66 mm
E76	Installation dimensions 270 x 76 mm
EAY	For vehicles with Easytronic transmission
EBR	Single-circuit brake system
EDS	For vehicles with EDL (electronic differential lock)
EFV	Also replacement for predecessor
EIZ	Brake caliper, one cylinder
ERH	For vehicles with increased payload
EZK	For vehicles with single cab
FAH	For driving school version
FBA	For vehicles with leaf-spring drive axle
FBM	For vehicles with brake booster with ABS
FBO	For vehicles with brake booster without ABS
FCC	For camper vehicle
FDO	For Ferodo system
FEN	For vehicles with standard suspension
FER	Interchangeable Bosch product or part for Fenner
FES	Fixed caliper brake
FEV	For vehicles with heavy-duty suspension
FFZ	For vehicles with dual-circuit brake system at front
FGN	For standard chassis
FGS	For chassis
FKL	For AC compressor
FKP	For delivery vans and flatbed trucks
FKR	For vehicles with short wheelbase
FLA	For vehicles with air-spring drive axle
FLB	Floating caliper brake from Lucas for ventilated brake disk
FLN	Floating caliper brake from Lucas for non-ventilated brake disk
FLR	For vehicles with long wheelbase
FMR	For vehicles with medium wheelbase
FMU	For vehicles with underride guard
FOU	For vehicles without underride guard
FSB	Floating caliper brake
FWA	For warning device
G10	Connecting thread M10 x 1
G12	Connecting thread M12 x 1
GES	For vehicles with cruise control system
GFO	For Girling system with floating caliper brake without ABS
GFR	Interchangeable Bosch product or part for Galfer
GIR	For Lucas-Girling system
GMC	For GM system
GRG	Control unit must be programmed before being used on vehicle, e.g. with KTS...
GS	For vehicles with manual transmission
H01	Also order and replace clamping sleeve 2 261 024 304
HAG	For vehicles with semi-automatic transmission
HTB	For vehicles with rear drum brake
IN	Interior
INB	Ventilated brake disk
INO	Non-ventilated brake disk
ITB	For ITT brake system
JUR	For Jurid system
KB2	Identification blue/blue
KBG	For chassis with box-type van floor panel and ambulances
KEL	For Kelsey-Hayes system
KHD	For vehicles with high roof
KL	For vehicles with air conditioner
KLO	For vehicles without air conditioner
KLR	For vehicles with short and long wheelbase
KM2	For station wagon M2
KOB	For station wagon
KW	For box-type van
KW2	Identification white/white
KZA	Identification: brown
KZB	Identification: blue
KZE	Identification: yellow

KZG	Identification: green
KZS	Identification: black
KZW	Identification: white
L01	Payload 800 kg
L02	Payload 1800 kg
L03	Payload under 1800 kg
L06	Payload 1000 kg
L07	Payload 1400 kg
L09	Payload 900 kg
L26	Length: 260 mm
L27	Length: 275 mm
L28	Length: 280 mm
L30	Length: 300 mm
L32	Length: 325 mm
L38	Length: 380 mm
L45	Length: 450 mm
L55	Length: 550 mm
LAB	Left side
LAU	For vehicles with L equipment
LF	For air suspension
LIM	For Saloon
LKR	For LHD vehicles with short wheelbase
LLE	For LHD vehicles
LN6	Not for 1000 kg payload
LOC	For Lockheed system
LUC	Interchangeable Bosch product or part for Lucas
LVF	Left side, for vehicles with heavy-duty suspension
LWG	For delivery van
LXA	For vehicles with LX equipment
MBB	For Mercedes-Benz brake/system
MC1	For model code 41, 45
MC2	For model code 41, 45, 81, 83, 85, 86, 87, 88
MC3	For model code 82, 84
MFD	For vehicles with ESP (electronic stability program)
MFL	With flange
MG5	For vehicles with 5-speed manual transmission
MG6	For vehicles with 6-speed manual transmission
MGN	Not for MG Advantage RL, GTA, Turbo
MI	Center
MIH	With holder
ML3	For vehicle model LN152
ML5	For vehicle model LN157
ML6	For vehicle model LN167
ML7	For vehicle model LN192
MND	For Mando system
MOT	Interchangeable Bosch product or part for Motorcraft
MTS	With parts set
MVB	For vehicles with brake lining wear indicator
NAA	Not for all-wheel drive
NAB	With hub
NAL	Not for vehicles with all-wheel steering
NAR	Bosch product without trigger wheel, use old part
NBA	Without hill holder
NBH	Not for official vehicle
NBU	Not for bus
NCC	Not for camper vehicle
NDS	Without swivel seat
NE5	Not for emission standard Euro 5
NKW	Not for box-type van
NNC	For vehicles with standard suspension, not for camper vehicle
NON	For vehicles with standard payload
NOR	Standard version
NPF	For vehicles without soot particle filter
NPW	Not for flatbed truck
NSZ	Not for rough roads
OAA	Without all-wheel drive
OAS	For vehicles without TCS (traction control system)
OBB	For vehicles without brake lining wear indicator
OBK	For vehicles without brake booster
OBS	For vehicles without brake assistant
ODM	Brake booster without twin diaphragm
OE	Fitted at top
OFD	For vehicles without ESP (electronic stability program)
OFZ	For vehicles without dual-circuit brake system at front
OGS	For vehicles without cruise control system
OHA	Without holder
OLF	For vehicles without air suspension
ORA	Identifier: orange
ORD	For vehicles without tire pressure monitoring system
OTF	For vehicles with independent wheel suspension
OTK	For vehicles without traction control
OVA	Without wear indicator
OZB	For vehicles with single tyres
PEO	For Perrot brake/system
PET	For Perrot and Textar system
PW	For flatbed truck
R14	For vehicles with 14 inch tires at rear
R16	For vehicles with 16 inch tires at rear
R30	For vehicles with 3000 mm wheelbase
R33	For vehicles with 3350 mm wheelbase
R34	For vehicles with 3500 mm and 4800 mm wheelbase
R35	For vehicles with 3550 mm wheelbase
R37	For vehicles with 3700 mm wheelbase
R38	For vehicles with 3800 mm wheelbase
R40	For vehicles with 4025 mm wheelbase
RAB	Right side
RDK	For vehicles with tire pressure monitoring system
RKR	For RHD vehicles with short wheelbase
RLB	Frame-type caliper brake from Lucas for ventilated brake disk
RLE	For RHD vehicles
RNF	Right side, for vehicles with standard suspension
RSA	Color coding: Pink
RSB	Frame-type caliper brake
RVF	Right side, for vehicles with heavy-duty suspension
SA	Special equipment
SAL	For vehicles with Salisbury rear axle, without limited slip differential
SAZ	Set
SBR	For vehicles with disk brakes
SE	On side
SEG	Electronically controlled manual transmission
SEN	Self-adjusting
SFZ	For special-purpose vehicles
SLX	For vehicles with SLX equipment
SSR	For vehicles with steel rims
STB	For vehicles with front disk brakes and rear drum brakes
STF	For vehicles with rigid axle
SUM	For Sumitomo system
T07	For drum brake 254 x 50 mm and wheel brake cylinder with piston diameter 20.6 mm
T08	For drum brake 280 x 63 mm and wheel brake cylinder with piston diameter 20.6 mm
TBR	For vehicles with drum brake
TEI	Parts set
TEJ	For ATE (Alfred Teves) and Jurid system
TEX	For Textar system
THE	Technical trade restriction, replacement can only be obtained from vehicle manufacturer
TNK	The vehicle data card is required for definite identification of the Bosch number. The components listed with the product must coincide with those on the data card.
TP1	For brake booster type A/C/D/E (refer to vehicle rating plate)
TP2	For brake booster type B (refer to vehicle rating plate)
TP3	For brake booster type N/Q/R/S (refer to vehicle rating plate)
TP4	For brake booster type P (refer to vehicle rating plate)
TR5	For 180 x 30 mm drum brake and wheel brake cylinder with 17.5 mm piston diameter
TRS	For traction unit with with special-purpose body
TW	The product fitted must be identified on the vehicle or engine.
UE	Installed at bottom
VAN	For VAN
VEA	Heavy-duty version
VFC	For vehicles with heavy-duty suspension, for camper vehicle
VFG	For heavy-duty chassis
VO	Front
WAB	Interchangeable Bosch product or part for Wabco
WIF	For chassis with cab only or with windshield only
WLC	Changeover contact
WW	Optional
X38	For vehicles with 3800 mm wheelbase and 3.5 t gross permissible weight
XXX	Available while stocks last
Z09	Diameter 9 inch
ZBR	For dual-circuit brake system
ZE	Two required
ZUB	Accessories included
ZWB	For vehicles with dual tires
ZWZ	Brake caliper, two cylinders
1	Inner
2	Outer
3	Front
4	Rear
6	With piston
7	Without piston
8	Parts set with guide sleeves
9	Without piston, with handbrake components
A	Load-sensitive
B	Combination with ABS control unit
E	Combination with ABS/ABD control unit
F	Combination with ABS/TCS control unit
H	ABS
J	ABS/TCS
K	ABS/ABD
M	ABS/TCS/ESP
O	Switchgear

P Relays	S Brake servo main brake cylinder set	T Combination with ABS/TCS/ESP control unit
 Commercial vehicle / small transporter	 Brake drum	 Acceleration sensor
 Engine power output in kW	 Drum-brake shoes	 Yaw sensor
 Capacity in l/ccm	 Drum-brake shoes kit super pro	 Steering-angle sensor
 Date/ Production period	 Hand-brake shoes	 Pressure sensor
WVA WVA-Number	 Accessory kit drum-brake shoes	
 Part number	 Disc-brake caliper	
 Exchange number	 Wheel-brake cylinder	
S Brake System	 Master cylinder	
 Special case	 Brake booster	
 Export market	 Clutch slave cylinder	
 Chassis-No.	 Clutch sensor cylinder	
 Dimensions	 Vacuum pump	
 Lining width	 Brake hose	
 left/right	 Hand-brake cable	
 Brake disk	 Load-sensing valve	
 Ventilated brake disk	 Hydraulic modulator	
 Non-ventilated brake disk	 ABS ECU	
 Disc-brake pad	 Control unit and relay	
 Wear indicator	 Rotational-speed sensor	



de

**Durchmesser-
identifikation**

**- Trommelbremsen-
backen**
(mm/inch)

en

**Diameter
identification**

- Drum-brake shoes
(mm/inch)

fr

**Identification
de diamètre**

**- Mâchoires de frein
à tambour**
(mm/inch)

it

**Identificazione
del diametro**

**- Ganasce per freni
a tamburo**
(mm/inch)

es

**Identificación
del diámetro**

**- Zapatas de
frenos de tambor**
(mm/inch)

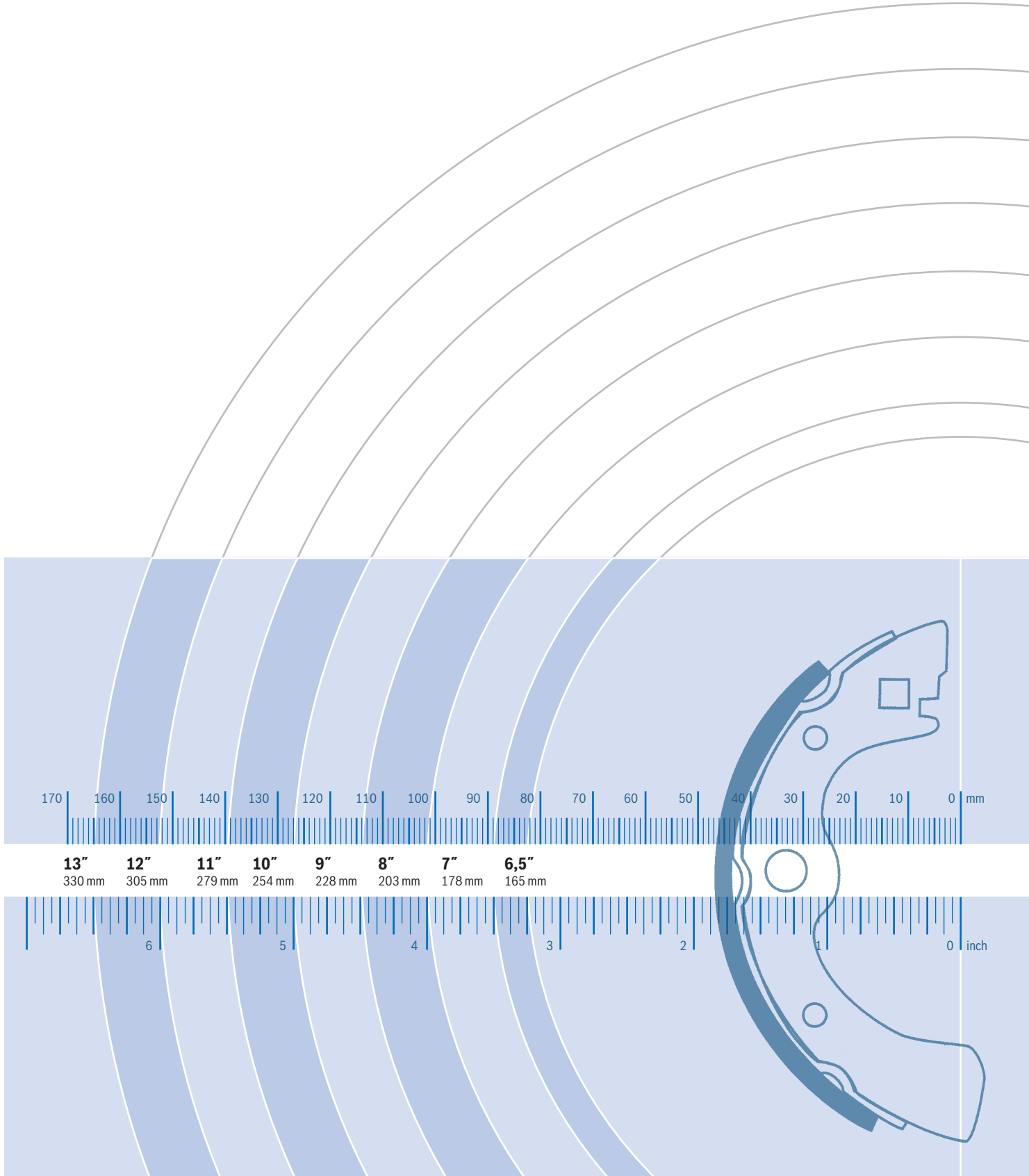



Professionally tested!



Satisfied customers!



**Quickly repaired
and replaced!**

de

**Sichere Diagnose.
Zeitsparende Reparatur.
Bosch-Diagnostics und
Ersatzteile.**

Alles aus einer Hand. Bosch bietet der Werkstatt ein Komplettprogramm zur Steigerung von Effizienz und Qualität in der täglichen Arbeit. Vom weltweit aktiven Entwickler und führenden Hersteller von Kfz-Systemtechnik kommen die Ersatzteile in bekannter Original-Qualität.

en

**Reliable diagnosis.
Time-saving repairs.
Bosch diagnostics and
service parts.**

Everything from one single source. Bosch has a complete program available which increases efficiency and quality in the workshop's daily work. The service parts from the globally active development expert and leading manufacturer of automotive system technology are in renowned Bosch OE quality.

fr

**Diagnostic fiable.
Réparation rapide.
Diagnostics et pièces
de rechange Bosch.**

Fournisseur unique, Bosch propose aux réparateurs une gamme complète qui améliore au quotidien l'efficacité et la qualité du travail. En tant que concepteur présent dans le monde entier et leader dans la fabrication de systèmes pour automobiles, ses pièces de rechange sont reconnues pour offrir la qualité des pièces d'origine.

it

Diagnosi sicure. Riparazioni rapide. Diagnostica, ricambi e formazione: tutto da un unico fornitore.

Bosch offre all'officina un programma completo per una maggior efficienza e qualità nel lavoro quotidiano d'autoriparazione. Con il programma «Diagnostics», Bosch mette a disposizione dell'officina anche hardware e software di diagnosi perfettamente in sintonia tra loro oltre a formazione, assistenza e consulenza tecnica. Competenza e qualità, quindi, per il futuro dell'officina.

es

**Diagnóstico seguro.
Ahorro de tiempo en la
reparación. Diagnosis
Bosch y piezas de recambio.**

Todo de un solo proveedor. Bosch, fabricante líder, ofrece al taller un programa completo para incrementar la eficacia y la calidad en el trabajo diario. Bajo el nombre de Diagnosis Bosch se ponen a disposición del taller el hardware y software compatibles entre sí, la formación técnica, la hotline técnica y la base de datos técnicos. Competencia y calidad para el futuro de su taller.



BOSCH

☎ 1 987 720 029/201001

AA/MK12 – 01.2010 – int

© 2010 Robert Bosch GmbH
Automotive Aftermarket
Postfach 41 09 60
76225 Karlsruhe

Token fee: € 15,00

www.bosch.de/aa

Editorial closing: 15.12.2009

Subject to change without notice.
Please direct questions and
comments to our Authorized
Representative in your country.
This edition supersedes all
previous editions.

